



**Part no.: 50121922**  
**SLE46CI-40.K2/4P**  
**Single beam safety device receiver**



Figure can vary



## Contents

- . Technical data
- . Dimensioned drawings
- . Electrical connection
- . Operation and display
- . Accessories
- . Notes



## Technical data

<b>Basic data</b>	
Series	46C
<b>Characteristic parameters</b>	
Type	2, IEC/EN 61496
Performance Level (PL)	c, EN ISO 13849-1:2008, In combination with MSI-TRMB-01 or MSI-TRMB-02 safety relay
MTTF <sub>d</sub>	400 years, EN ISO 13849-1
Mission time T <sub>M</sub>	20 years, EN ISO 13849-1
Category	2, EN ISO 13849:2008, In combination with MSI-TRMB-01 or MSI-TRMB-02 safety relay
<b>Timing</b>	
Switching frequency	250 Hz
Response time	2.5 ms
Readiness delay	300 ms
<b>Electrical data</b>	
Protective circuit	Short circuit protected, Polarity reversal protection
<b>Performance data</b>	
Supply voltage	24 V, DC, -20 ... 20 %, Incl. residual ripple
Residual ripple	10 %, From U <sub>B</sub>
Open-circuit current	0 ... 15 mA
<b>Outputs</b>	
Number of digital switching outputs	2 Piece(s)
<b>Switching outputs</b>	
Switching voltage high, min.	22 V
Switching voltage low, max.	2 V
Switching voltage, typ.	23 V
Voltage type	DC
Switching current, max.	100 mA
<b>Switching output 1</b>	
Assignment	Connection 1, conductor 2
Switching element	Transistor, PNP
Switching principle	Dark switching
Function	Diagnostic output
<b>Switching output 2</b>	
Assignment	Connection 1, conductor 4
Switching element	Transistor, PNP
Switching principle	Light switching
Function	Switching output
<b>Connection</b>	
Number of connections	1 Piece(s)

## Part no.: 50121922 – SLE46CI-40.K2/4P – Single beam safety device receiver

### Connection 1

Type of connection	Cable
Function	Signal OUT, Voltage supply
Cable length	2.000 mm
Sheathing material	PUR
Number of conductors	4 -wire
Core cross section	0.21 mm <sup>2</sup>

### Mechanical data

Design	Cubic
Width	20.5 mm x 76.3 mm x 44 mm
Housing material	Plastic, PC-PBT
Lens cover material	Plastic (PMMA)
Net weight	100 g
Housing color	Red
Type of fastening	Through-hole mounting

### Operation and display

Type of display	LED
Number of LEDs	2 Piece(s)

### Environmental data

Ambient temperature, operation	-30 ... 60 °C
Ambient temperature, storage	-30 ... 70 °C
Environmental test	ECOLAB

### Certifications

Degree of protection	IP 67, IP 69K
Protection class	III, Rating voltage 50 V
Certifications	c UL US, TÜV Süd
Standards applied	IEC 60947-5-2, IEC/EN 61496

### Functions

Functions	Alignment indicator, Diagnostic output
-----------	--

### Classification

eCl@ss 8.0	27272701
eCl@ss 9.0	27272701
ETIM 5.0	EC001831

## Dimensioned drawings

All dimensions in millimeters

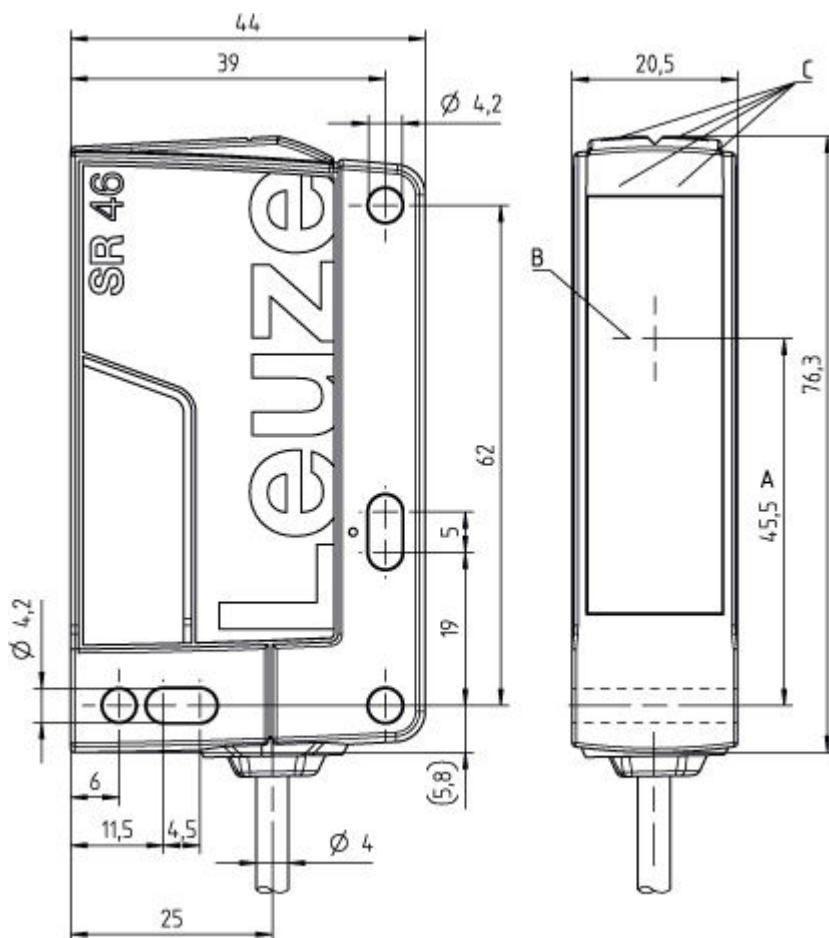

- A Optical axis
- B Transmitter and receiver
- C Green/yellow indicator diodes

## Electrical connection

Connection 1	
Type of connection	Cable
Function	Signal OUT, Voltage supply
Cable length	2.000 mm
Sheathing material	PUR
Cable color	Black
Number of conductors	4 -wire
Core cross section	0.21 mm <sup>2</sup>

Conductor color	Conductor assignment
Brown	+24V
White	Diagnosis
Blue	GND
Black	OUT

## Operation and display

### LEDs





LED	Display	Meaning
1	Green, continuous light	Ready
2	Yellow, continuous light	Light path free

## Accessories





### Mounting technology - Mounting brackets

	Part no.	Designation	Article	Description
	50105315	BT 46	Mounting device	Design of mounting device: Angle, L-shape Mounting bracket, at system: Through-hole mounting Mounting bracket, at device: Screw type Type of mounting device: Rigid Material: Metal

### Mounting technology - Rod mounts

	Part no.	Designation	Article	Description
	50117253	BTU 300M-D10	Mounting system	Contains: 2x M4 x 25 screw, 2x M4 x 20 screw, 4x position washers Design of mounting device: Mounting system Mounting bracket, at system: For 10 mm rod, Sheet-metal mounting Mounting bracket, at device: Screw type Type of mounting device: Clampable, Adjustable, Turning, 360° Material: Metal
	50117252	BTU 300M-D12	Mounting system	Contains: 2x M4 x 25 screw, 2x M4 x 20 screw, 4x position washers Design of mounting device: Mounting system Mounting bracket, at system: For 12 mm rod, Sheet-metal mounting Mounting bracket, at device: Screw type Type of mounting device: Clampable, Adjustable, Turning, 360° Material: Metal
	50117251	BTU 300M-D14	Mounting system	Contains: 2x M4 x 25 screw, 2x M4 x 20 screw, 4x position washers Design of mounting device: Mounting system Mounting bracket, at system: For 14 mm rod, Sheet-metal mounting Mounting bracket, at device: Screw type Type of mounting device: Clampable, Adjustable, Turning, 360° Material: Metal
	50120425	BTU 300M.5-D12	Mounting system	Contains: 2x M4 x 25 screw, 2x M4 x 20 screw, 2x position washers, 2x M4 mounting nut Design of mounting device: Mounting system Mounting bracket, at system: For 12 mm rod, Sheet-metal mounting Mounting bracket, at device: Screw type Type of mounting device: Clampable, Adjustable, Turning, 360° Material: Stainless steel
	50122797	BTU 346M-D12	Mounting system	Contains: 2x M4 x 25 screw, 2x position washers Design of mounting device: Mounting system Mounting bracket, at system: For 12 mm rod, Sheet-metal mounting Mounting bracket, at device: Screw type Type of mounting device: Turning, 360°, Clampable, Adjustable Material: Metal

Part no.: 50121922 – SLE46CI-40.K2/4P – Single beam safety device receiver

	Part no.	Designation	Article	Description
	50122798	BTU 346M.5-D12	Mounting system	Design of mounting device: Mounting system Mounting bracket, at system: For 12 mm rod, Sheet-metal mounting Mounting bracket, at device: Screw type Type of mounting device: Turning, 360°, Clampable, Adjustable Material: Stainless steel
	50119332	BTU 900M-D10	Mounting system	Contains: 2x M4 x 10 screw, 2x position washers Design of mounting device: Mounting system Mounting bracket, at system: For 10 mm rod, Sheet-metal mounting Mounting bracket, at device: Screw type Type of mounting device: Clampable, Turning, 360°, Swiveling Material: Metal
	50119331	BTU 900M-D12	Mounting system	Contains: 2x position washers, 2x M4 x 10 screw Design of mounting device: Mounting system Mounting bracket, at system: For 12 mm rod, Sheet-metal mounting Mounting bracket, at device: Screw type Type of mounting device: Clampable, Turning, 360°, Swiveling Material: Metal
	50119330	BTU 900M-D14	Mounting system	Contains: 2x position washers, 2x M4 x 10 screw Design of mounting device: Mounting system Mounting bracket, at system: For 14 mm rod, Sheet-metal mounting Mounting bracket, at device: Screw type Type of mounting device: Clampable, Turning, 360°, Swiveling Material: Metal

## Notes

### Observe intended use!

- The product may only be put into operation by competent persons.
- Only use the product in accordance with its intended use.

### For UL applications:

- Certification: UL 508, C22.2 No.14-13
- Only for use in "class 2" circuits
- These proximity switches shall be used with UL Listed Cable assemblies rated 30V, 0.5A min, in the field installation, or equivalent (categories: CYJV/CYJV7 or PVVA/PVVA7)

- Average life expectancy 100,000 h at an ambient temperature of 25 °C