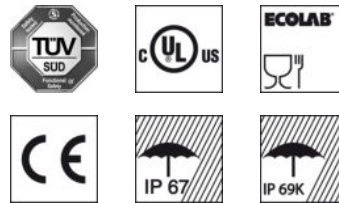



Figure can vary

Part no.: 50121915
SLE46C-70.K2/4P-M12
Single beam safety device receiver



Contents

- Technical data
- Dimensioned drawings
- Electrical connection
- Operation and display
- Accessories
- Notes



Part no.: 50121915 – SLE46C-70.K2/4P-M12 – Single beam safety device

Technical data

Basic data	
Series	46C
Characteristic parameters	
Type	2, IEC/EN 61496
Performance Level (PL)	c, EN ISO 13849-1:2008, In combination with MSI-TRMB-01 or MSI-TRMB-02 safety relay
MTTF _d	400 years, EN ISO 13849-1
Mission time T _M	20 years, EN ISO 13849-1
Category	2, EN ISO 13849:2008, In combination with MSI-TRMB-01 or MSI-TRMB-02 safety relay
Timing	
Switching frequency	250 Hz
Response time	2.5 ms
Readiness delay	300 ms
Electrical data	
Protective circuit	Polarity reversal protection, Short circuit protected
Performance data	
Supply voltage	24 V, DC, -20 ... 20 %, Incl. residual ripple
Residual ripple	10 %, From U _B
Open-circuit current	0 ... 15 mA
Outputs	
Number of digital switching outputs	2 Piece(s)
Switching outputs	
Switching voltage high, min.	22 V
Switching voltage low, max.	2 V
Switching voltage, typ.	23 V
Voltage type	DC
Switching current, max.	100 mA
Switching output 1	
Assignment	Connection 1, pin 2
Switching element	Transistor, PNP
Switching principle	Dark switching
Function	Diagnostic output
Switching output 2	
Assignment	Connection 1, pin 4
Switching element	Transistor, PNP
Switching principle	Light switching
Function	Switching output
Connection	
Number of connections	1 Piece(s)

Part no.: 50121915 – SLE46C-70.K2/4P-M12 – Single beam safety device

Connection 1

Type of connection	Connector
Function	Signal OUT, Voltage supply
Thread size	M12
Material	Plastic
No. of pins	4 -pin

Mechanical data

Design	Cubic
Width	20.5 mm x 76.3 mm x 44 mm
Housing material	Plastic, PC-PBT
Lens cover material	Plastic (PMMA)
Net weight	50 g
Housing color	Red
Type of fastening	Through-hole mounting

Operation and display

Type of display	LED
Number of LEDs	2 Piece(s)

Environmental data

Ambient temperature, operation	-30 ... 60 °C
Ambient temperature, storage	-30 ... 70 °C
Environmental test	ECOLAB

Certifications

Degree of protection	IP 67, IP 69K
Protection class	III, Rating voltage 50 V
Certifications	TÜV Süd, c UL US
Standards applied	IEC 60947-5-2, IEC/EN 61496

Functions

Functions	Alignment indicator, Diagnostic output
-----------	--

Classification

eCl@ss 8.0	27272701
eCl@ss 9.0	27272701
ETIM 5.0	EC001831

Dimensioned drawings

All dimensions in millimeters

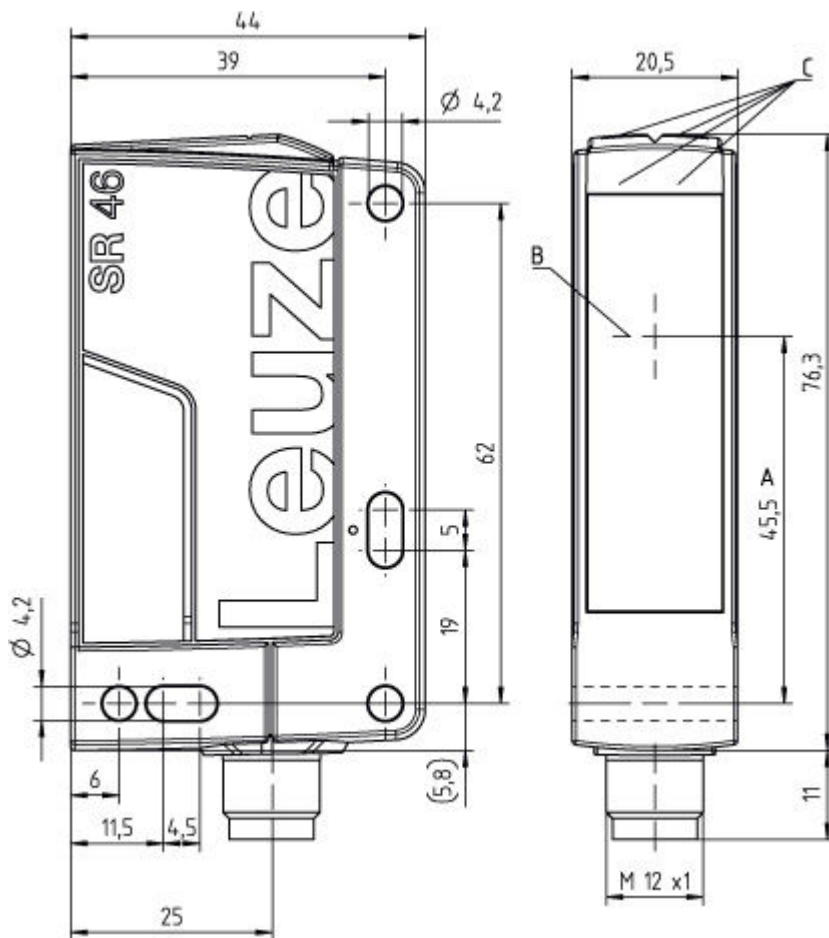

- A Optical axis
- B Transmitter and receiver
- C Green/yellow indicator diodes

Electrical connection

Connection 1	
Type of connection	Connector
Function	Signal OUT, Voltage supply
Thread size	M12
Type	Male
Material	Plastic
No. of pins	4 -pin
Encoding	A-coded

Pin	Pin assignment
1	+24V
2	Diagnosis
3	GND
4	OUT

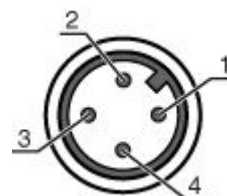







Operation and display

LEDs





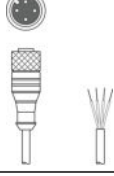

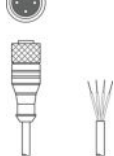
LED	Display	Meaning
1	Green, continuous light	Ready
2	Yellow, continuous light	Light path free

Accessories

Connection technology - Connection cables

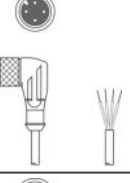
	Part no.	Designation	Article	Description
	50104565	K-D M12A-4P-10m-PUR	Connection cable	Connection 1: Connector, M12, Axial, Female, A-coded, 4 -pin Connection 2: Open end Shielded: No Cable length: 10,000 mm Sheathing material: PUR
	50104546	K-D M12A-4P-10m-PVC	Connection cable	Connection 1: Connector, M12, Axial, Female, A-coded, 4 -pin Connection 2: Open end Shielded: No Cable length: 10,000 mm Sheathing material: PVC
	50104753	K-D M12A-4P-20m-PVC	Connection cable	Connection 1: Connector, M12, Axial, Female, A-coded, 4 -pin Connection 2: Open end Shielded: No Cable length: 20,000 mm Sheathing material: PVC
	50104561	K-D M12A-4P-2m-PUR	Connection cable	Connection 1: Connector, M12, Axial, Female, A-coded, 4 -pin Connection 2: Open end Shielded: No Cable length: 2,000 mm Sheathing material: PUR
	50104542	K-D M12A-4P-2m-PVC	Connection cable	Connection 1: Connector, M12, Axial, Female, A-coded, 4 -pin Connection 2: Open end Shielded: No Cable length: 2,000 mm Sheathing material: PVC
	50123532	K-D M12A-4P-30m-PVC	Connection cable	Connection 1: Connector, M12, Axial, Female, A-coded, 4 -pin Connection 2: Open end Shielded: No Cable length: 30,000 mm Sheathing material: PVC
	50104563	K-D M12A-4P-5m-PUR	Connection cable	Connection 1: Connector, M12, Axial, Female, A-coded, 4 -pin Connection 2: Open end Shielded: No Cable length: 5,000 mm Sheathing material: PUR

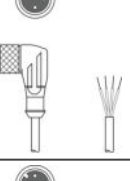
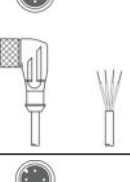
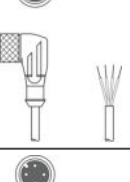
Part no.: 50121915 – SLE46C-70.K2/4P-M12 – Single beam safety device

	Part no.	Designation	Article	Description
	50104544	K-D M12A-4P-5m-PVC	Connection cable	Connection 1: Connector, M12, Axial, Female, A-coded, 4 -pin Connection 2: Open end Shielded: No Cable length: 5,000 mm Sheathing material: PVC
	50104566	K-D M12W-4P-10m-PUR	Connection cable	Connection 1: Connector, M12, Angled, Female, A-coded, 4 -pin Connection 2: Open end Shielded: No Cable length: 10,000 mm Sheathing material: PUR
	50104547	K-D M12W-4P-10m-PVC	Connection cable	Connection 1: Connector, M12, Angled, Female, A-coded, 4 -pin Connection 2: Open end Shielded: No Cable length: 10,000 mm Sheathing material: PVC
	50113473	K-D M12W-4P-20M-PVC	Connection cable	Connection 1: Connector, M12, Angled, Female, A-coded, 4 -pin Connection 2: Open end Shielded: No Cable length: 20,000 mm Sheathing material: PVC
	50104562	K-D M12W-4P-2m-PUR	Connection cable	Connection 1: Connector, M12, Angled, Female, A-coded, 4 -pin Connection 2: Open end Shielded: No Cable length: 2,000 mm Sheathing material: PUR
	50104543	K-D M12W-4P-2m-PVC	Connection cable	Connection 1: Connector, M12, Angled, Female, A-coded, 4 -pin Connection 2: Open end Shielded: No Cable length: 2,000 mm Sheathing material: PVC
	50104564	K-D M12W-4P-5m-PUR	Connection cable	Connection 1: Connector, M12, Angled, Female, A-coded, 4 -pin Connection 2: Open end Shielded: No Cable length: 5,000 mm Sheathing material: PUR
	50104545	K-D M12W-4P-5m-PVC	Connection cable	Connection 1: Connector, M12, Angled, Female, A-coded, 4 -pin Connection 2: Open end Shielded: No Cable length: 5,000 mm Sheathing material: PVC

Mounting technology - Mounting brackets

	Part no.	Designation	Article	Description
	50105315	BT 46	Mounting device	Design of mounting device: Angle, L-shape Mounting bracket, at system: Through-hole mounting Mounting bracket, at device: Screw type Type of mounting device: Rigid Material: Metal

Part no.: 50121915 – SLE46C-70.K2/4P-M12 – Single beam safety device

Mounting technology - Rod mounts

	Part no.	Designation	Article	Description
	50117253	BTU 300M-D10	Mounting system	Contains: 2x M4 x 25 screw, 2x M4 x 20 screw, 4x position washers Design of mounting device: Mounting system Mounting bracket, at system: For 10 mm rod, Sheet-metal mounting Mounting bracket, at device: Screw type Type of mounting device: Clampable, Adjustable, Turning, 360° Material: Metal
	50117252	BTU 300M-D12	Mounting system	Contains: 2x M4 x 25 screw, 2x M4 x 20 screw, 4x position washers Design of mounting device: Mounting system Mounting bracket, at system: For 12 mm rod, Sheet-metal mounting Mounting bracket, at device: Screw type Type of mounting device: Clampable, Adjustable, Turning, 360° Material: Metal
	50117251	BTU 300M-D14	Mounting system	Contains: 2x M4 x 25 screw, 2x M4 x 20 screw, 4x position washers Design of mounting device: Mounting system Mounting bracket, at system: For 14 mm rod, Sheet-metal mounting Mounting bracket, at device: Screw type Type of mounting device: Clampable, Adjustable, Turning, 360° Material: Metal
	50120425	BTU 300M.5-D12	Mounting system	Contains: 2x M4 x 25 screw, 2x M4 x 20 screw, 2x position washers, 2x M4 mounting nut Design of mounting device: Mounting system Mounting bracket, at system: For 12 mm rod, Sheet-metal mounting Mounting bracket, at device: Screw type Type of mounting device: Clampable, Adjustable, Turning, 360° Material: Stainless steel
	50122797	BTU 346M-D12	Mounting system	Contains: 2x M4 x 25 screw, 2x position washers Design of mounting device: Mounting system Mounting bracket, at system: For 12 mm rod, Sheet-metal mounting Mounting bracket, at device: Screw type Type of mounting device: Turning, 360°, Clampable, Adjustable Material: Metal
	50122798	BTU 346M.5-D12	Mounting system	Design of mounting device: Mounting system Mounting bracket, at system: For 12 mm rod, Sheet-metal mounting Mounting bracket, at device: Screw type Type of mounting device: Turning, 360°, Clampable, Adjustable Material: Stainless steel
	50119332	BTU 900M-D10	Mounting system	Contains: 2x M4 x 10 screw, 2x position washers Design of mounting device: Mounting system Mounting bracket, at system: For 10 mm rod, Sheet-metal mounting Mounting bracket, at device: Screw type Type of mounting device: Clampable, Turning, 360°, Swiveling Material: Metal
	50119331	BTU 900M-D12	Mounting system	Contains: 2x position washers, 2x M4 x 10 screw Design of mounting device: Mounting system Mounting bracket, at system: For 12 mm rod, Sheet-metal mounting Mounting bracket, at device: Screw type Type of mounting device: Clampable, Turning, 360°, Swiveling Material: Metal
	50119330	BTU 900M-D14	Mounting system	Contains: 2x position washers, 2x M4 x 10 screw Design of mounting device: Mounting system Mounting bracket, at system: For 14 mm rod, Sheet-metal mounting Mounting bracket, at device: Screw type Type of mounting device: Clampable, Turning, 360°, Swiveling Material: Metal

Notes

Observe intended use!

- The product may only be put into operation by competent persons.
- Only use the product in accordance with its intended use.

For UL applications:

- Certification: UL 508, C22.2 No.14-13
- Only for use in "class 2" circuits
- These proximity switches shall be used with UL Listed Cable assemblies rated 30V, 0.5A min, in the field installation, or equivalent (categories: CYJV/CYJV7 or PVVA/PVVA7)

- Average life expectancy 100,000 h at an ambient temperature of 25 °C