

Ball Lock Cylinder

2 larger sizes added to the lineup! (April, 2019)

Model WKA



Spring Lock Design

Securely Transfers Pallets and Prevents Pallet Drops

The light weight and compact design allows for maximizing the robot's ability without reducing its portable weight.

The ball lock cylinder is used for transfer pallets, plates, temporary tool stocker, etc.

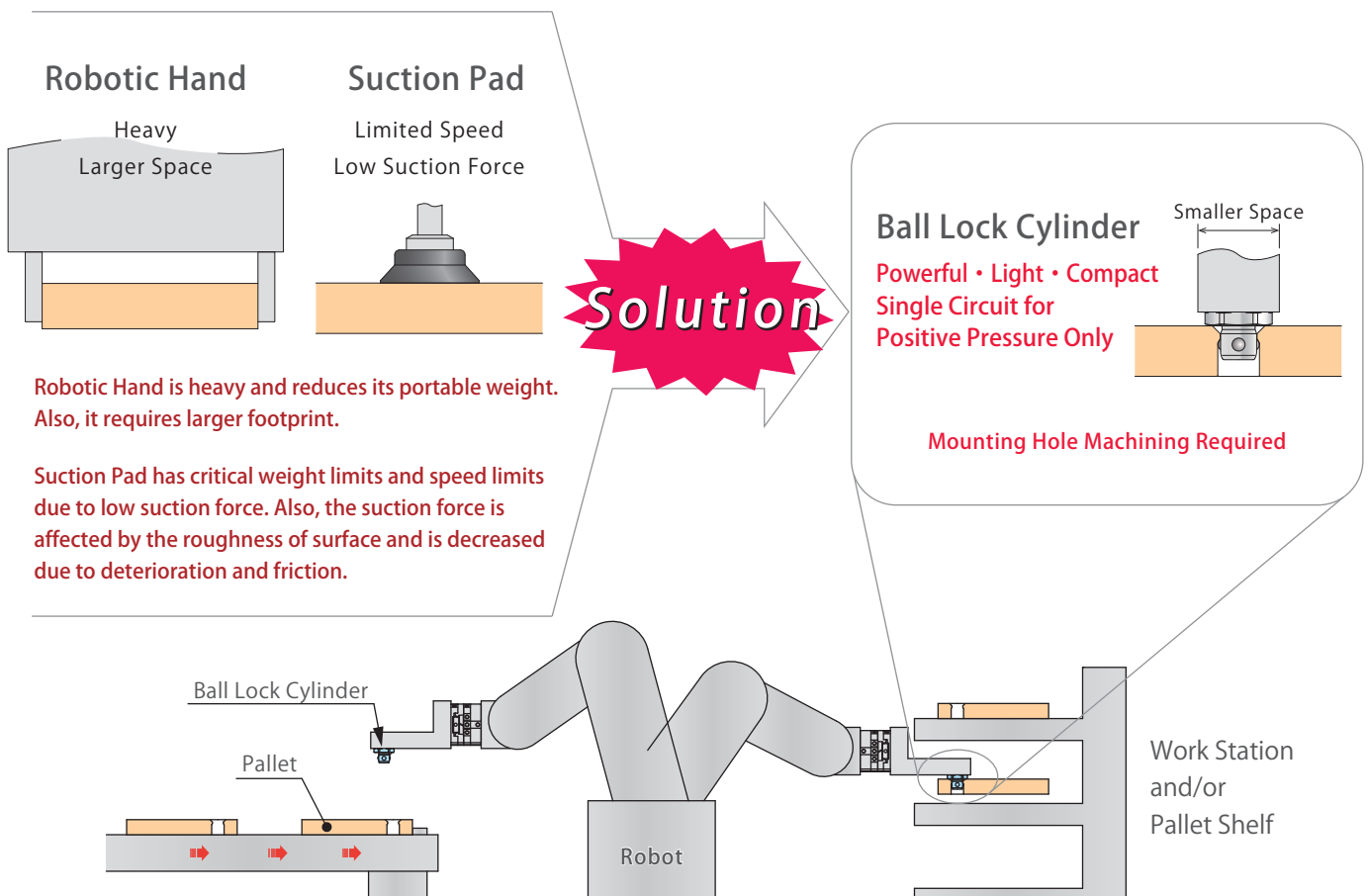

● Application Examples

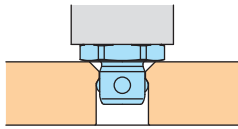

Pallet Transfer

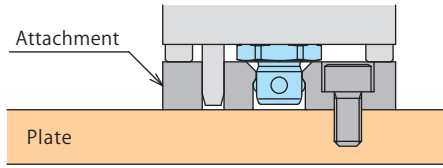

Install attachments for plates that cannot have workpiece holes.

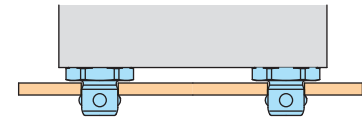
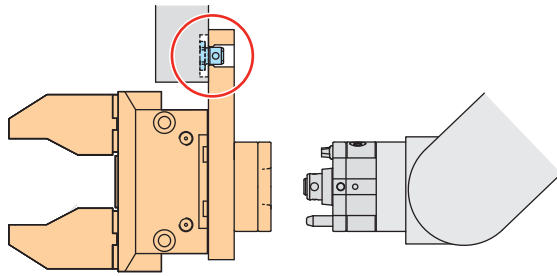
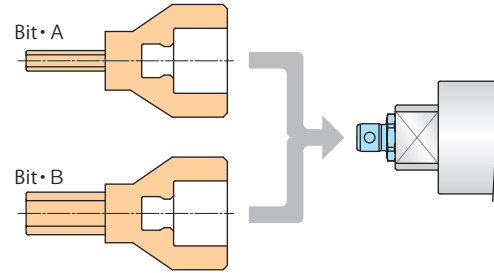

Plate Transfer



Temporary Stopper/Falling Prevention for Stocker



Bit/Tool Change

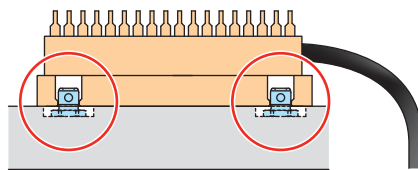

Falling Prevention for Nozzle Unit

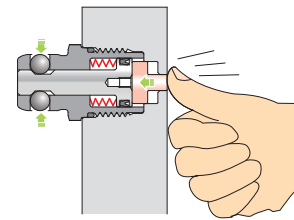

Used by Hand or Another Cylinder

● Action Description ※ This is a simplified drawing. Actual components are different.

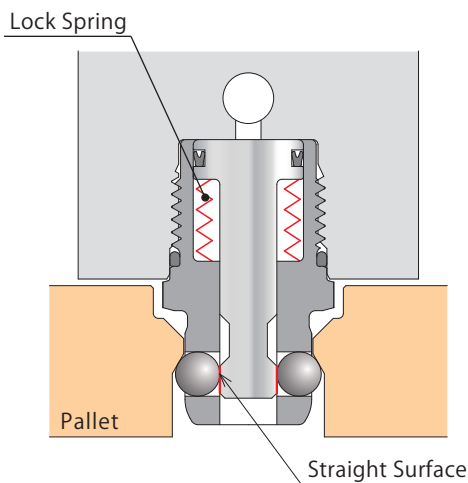

Transferring (Lock)

Release Air Pressure

OFF

The piston is pulled down via internal spring and the steel balls will expand. The steel balls will engage with the straight surface to hold the pallet. The ball lock cylinder maintains clamping force even with air pressure loss during power failure.

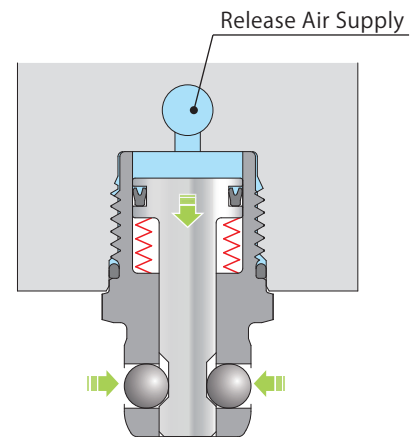

Loading/Unloading (Release)

Release Air Pressure

ON

The piston is pushed by air pressure (positive pressure) and the steel balls will be set inside the cylinder.

Low Air Consumption and Low Running Cost.

Locating + Clamp

Locating

Hand + Clamp

Support

Valve + Coupler

Cautions + Others

Pallet Gripper

WVA

Locating Pin Clamp

SWP

High-Power Pull Stud Clamp

WPT

JES

FA Pneumatic Hole Clamp

WKH

Lifting Hole Clamp

SWJ

Ball Lock Cylinder

WKA

Pneumatic Robotic Hands

WPW-C

WPS-C

WPA

WPH

WPP

WPQ

Auto Switch Proximity Switch

JEP

High-Power Pneumatic Hole Clamp

SWE

High-Power Pneumatic Swing Clamp

WHE

High-Power Pneumatic Link Clamp

WCE

Pneumatic Hole Clamp

SWA

Pneumatic Swing Clamp

WHA

Double Piston Pneumatic Swing Clamp

WHD

Pneumatic Link Clamp

WCA

Air Flow Control Valve

BZW

Manifold Block

WHZ-MD

Model No. Indication

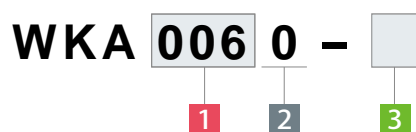

1 Body Size

- 006** : Released Diameter ϕ 6.5 Pulling Capacity (Holding Force) 50N
008 : Released Diameter ϕ 8 Pulling Capacity (Holding Force) 70N
010 : Released Diameter ϕ 10 Pulling Capacity (Holding Force) 100N
012 : Released Diameter ϕ 12 Pulling Capacity (Holding Force) 150N
016 : Released Diameter ϕ 16 Pulling Capacity (Holding Force) 200N

2 Design No.

- 0** : Revision Number

3 Operating Temperature (Sealing Material)

- Blank** : Standard Temperature (Operating Temperature 0 ~ 70°C) Sealing Material: Nitrile Rubber
V : High Temperature (Operating Temperature 0 ~ 120°C) Sealing Material: Fluorine Rubber

Specifications

Model No.		WKA0060-□	WKA0080-□	WKA0100-□	WKA0120-□	WKA0160-□
Pulling Capacity (Holding Force)	N	50	70	100	150	200
Release Cylinder Capacity	cm ³	0.08	0.08	0.15	0.26	0.49
Max. Operating Pressure	MPa	0.7				
Min. Operating Pressure	MPa	0.25				
Withstanding Pressure	MPa	1.0				
Operating Temperature	°C	0 ~ 70				
	°C	0 ~ 120				
Usable Fluid		Dry Air				
Weight	g	7	8	13	20	41

External Dimensions

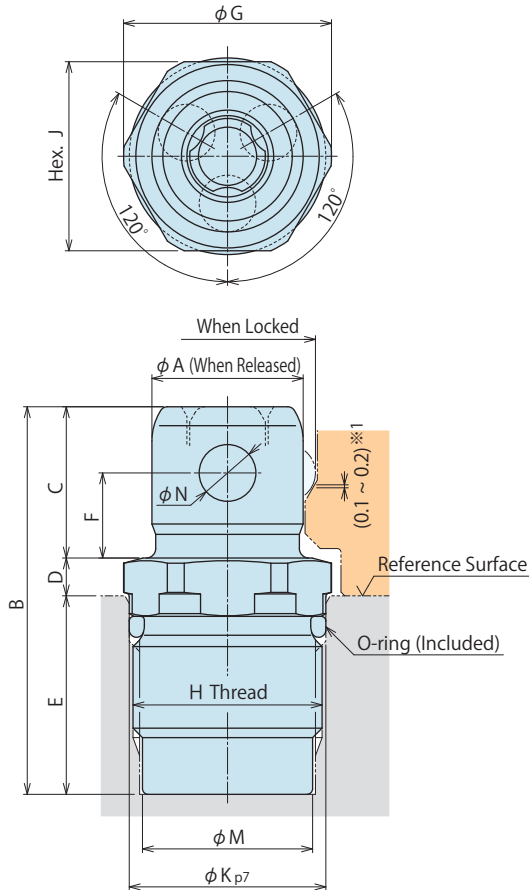

Workpiece Hole Reference Dimensions

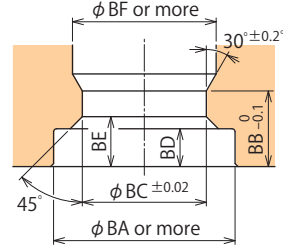

Mounting Hole Machining Dimensions

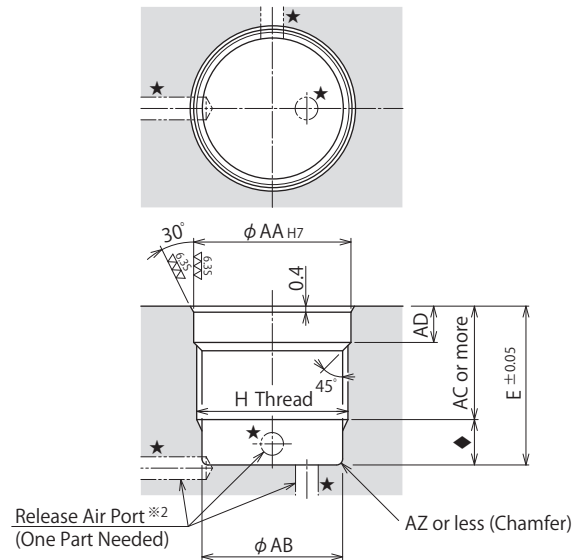

Note :

※1. There is a gap between a workpiece hole and a cylinder when locked (when expanded).

※2. Release air pressure can be supplied from the side or the bottom surface of the mounting hole (★ part).

If machining the release air port on the side, please machine it within ◆ area.

External Dimensions and Machining Dimensions for Mounting

Model No.		WKA0060-□	WKA0080-□	WKA0100-□	WKA0120-□	WKA0160-□
Diameter	A (Released)	6.5 ⁰ _{-0.05}	8 ⁰ _{-0.05}	10 ⁰ _{-0.05}	12 ⁰ _{-0.05}	16 ⁰ _{-0.05}
	Locked	7.7	9.3	11.5	13.8	18.2
B		19.5	20.5	22.5	25	29.5
C		7	8	9	10	11.5
D		2	2	2.5	3	4
E		10.5	10.5	11	12	14
F		4	4.5	5	5.5	6.5
G		11	11	13.5	15.5	21.2
H (Nominal × Pitch)		M10×0.75	M10×0.75	M12×1	M14×1	M18×1.5
J		10	10	12	14	19
K		10.4 ^{+0.036} _{+0.018}	10.4 ^{+0.036} _{+0.018}	12.4 ^{+0.036} _{+0.018}	14.4 ^{+0.036} _{+0.018}	19.4 ^{+0.043} _{+0.022}
M		9	9	10.7	12.7	16.1
N		2.5	3	3.5	4	5
O-ring		SS8.5 (NOK-made)	SS8.5 (NOK-made)	SS10.5 (NOK-made)	S12 (NOK-made)	AS568-016
AA		10.4 ^{+0.018} ₀	10.4 ^{+0.018} ₀	12.4 ^{+0.018} ₀	14.4 ^{+0.018} ₀	19.4 ^{+0.021} ₀
AB		9.3 ^{+0.07} _{-0.11}	9.3 ^{+0.07} _{-0.11}	11 ^{+0.15} _{-0.08}	13 ^{+0.15} _{-0.08}	16.5 ^{+0.17} _{-0.12}
AC		7.5	7.5	8	9	10.5
AD		2.4	2.4	2.4	2.8	3.8
AZ (Chamfer)		0.2	0.2	0.4	0.4	0.4
BA		12	12	14.5	17	23
BB		4.7	5	5.8	6.45	8
BC		6.7	8.2	10.2	12.2	16.2
BD		2.5	2.5	3	3.5	4.5
BE		3.3	3.3	4.6	4.9	6.5
BF		7.9	9.5	11.7	14.2	18.6

Locating + Clamp
Locating
Hand + Clamp
Support
Valve + Coupler
Cautions + Others

Pallet Gripper
WVA
Locating Pin Clamp
SWP
High-Power Pull Stud Clamp
WPT
JES
FA Pneumatic Hole Clamp
WKH
Lifting Hole Clamp
SWJ

Ball Lock Cylinder
WKA
Pneumatic Robotic Hands
WPW-C
WPS-C
WPA
WPH
WPP
WPQ

Auto Switch Proximity Switch
JEP
High-Power Pneumatic Hole Clamp
SWE
High-Power Pneumatic Swing Clamp
WHE
High-Power Pneumatic Link Clamp
WCE
Pneumatic Hole Clamp
SWA

Pneumatic Swing Clamp
WHA
Double Piston Pneumatic Swing Clamp
WHD
Pneumatic Link Clamp
WCA

Air Flow Control Valve
BZW
Manifold Block
WHZ-MD

Accessory : Attachment for WKA

Attachment for WKA

Model No. Indication

WKAZ 06 0 - B

Size
(Refer to the following table)

Design No.
(Revision Number)

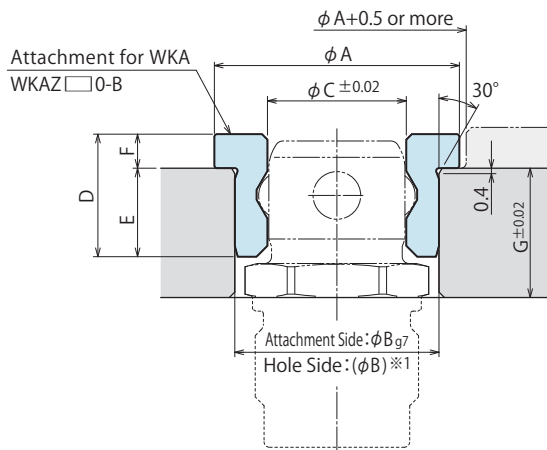

(mm)

Model No.	WKAZ060-B	WKAZ080-B	WKAZ100-B	WKAZ120-B	WKAZ160-B	
Corresponding Model No.	WKA0060-□	WKA0080-□	WKA0100-□	WKA0120-□	WKA0160-□	
A	14	14	18	20	26	
B	Attachment	12 ^{-0.006} / _{-0.024}	12 ^{-0.006} / _{-0.024}	15 ^{-0.006} / _{-0.024}	17 ^{-0.006} / _{-0.024}	23 ^{-0.007} / _{-0.028}
	Hole	(12) *1	(12) *1	(15) *1	(17) *1	(23) *1
C	6.7	8.2	10.2	12.2	16.2	
D	7.5	7.5	9	10	11.5	
E	5.5	5.5	6.5	7.5	8.5	
F	2	2	2.5	2.5	3	
G	8	8	9.5	11	13	
Weight	5 g	4 g	8 g	10 g	19 g	

Notes :

1. Material : Martensitic Stainless Steel (HRC29 ~ 33)

*1. Hole Side : Determine φB tolerance of mounting hole based on the dimensions of the attachment.
(Refer to the following attachment mounting examples.)

Attachment Mounting Examples

【Press-Fit Mounting】

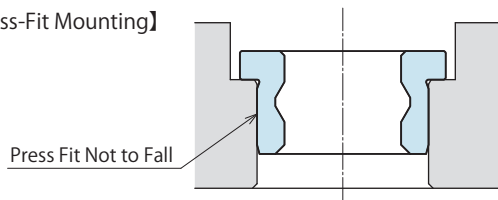

【Mounting with a Cover】

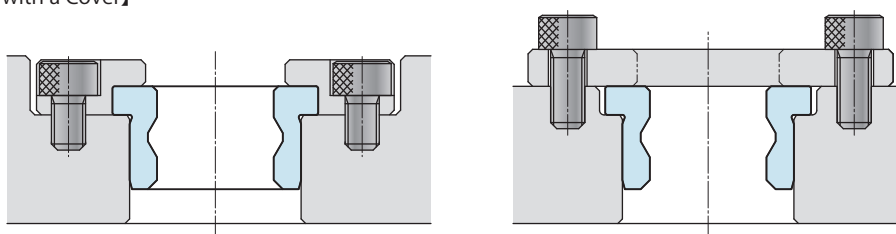

● Accessory : Manifold Block for WKA

Manifold Block for WKA

Model No. Indication

WKAZ 06 0 – MS

Size
(Refer to the following table)

Design No.
(Revision Number)

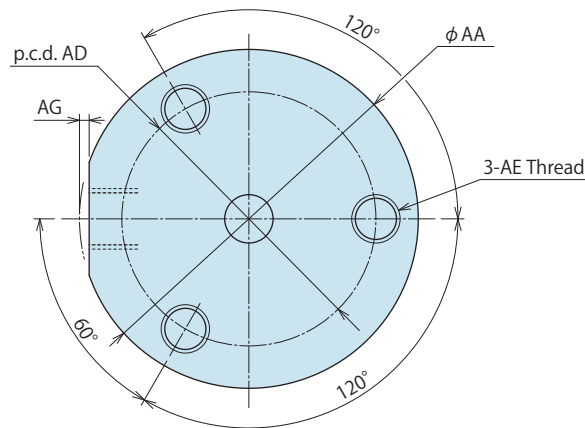
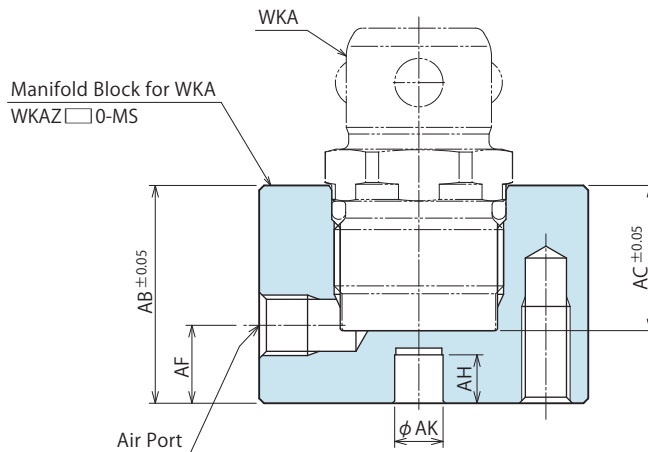

(mm)

Model No.	WKAZ060-MS	WKAZ100-MS	WKAZ120-MS	WKAZ160-MS
Corresponding Model No.	WKA0060-□	WKA0080-□	WKA0100-□	WKA0160-□
AA	20	22	28	32
AB	15	16	18	20
AC	10.5	11	12	14
AD	15	17	21	25
AE	M3×0.5 Thread Depth 6	M3×0.5 Thread Depth 6	M4×0.7 Thread Depth 8	M4×0.7 Thread Depth 8
Air Port	M3 Thread	M3 Thread	M5 Thread	M5 Thread
AF	5	5	6	6
AG	0.5	0.5	0.8	0.8
AK	2 ^{+0.03} ₀	3 ^{+0.03} ₀	4 ^{+0.03} ₀	4 ^{+0.03} ₀
AH	2	3	4	4
Weight	10g	13g	24g	33g

Note :

1. Material : A2017BE-T4 Surface Finishing : Anodized Aluminum Finishing

Locating + Clamp

Locating

Hand + Clamp

Support

Valve + Coupler

Cautions + Others

Pallet Gripper

WVA

Locating Pin Clamp

SWP

High-Power Pull Stud Clamp

WPT

JES

FA Pneumatic Hole Clamp

WKH

Lifting Hole Clamp

SWJ

Ball Lock Cylinder

WKA

Pneumatic Robotic Hands

WPW-C

WPS-C

WPA

WPH

WPP

WPQ

Auto Switch Proximity Switch

JEP

High-Power Pneumatic Hole Clamp

SWE

High-Power Pneumatic Swing Clamp

WHE

High-Power Pneumatic Link Clamp

WCE

Pneumatic Hole Clamp

SWA

Pneumatic Swing Clamp

WHA

Double Piston Pneumatic Swing Clamp

WHD

Pneumatic Link Clamp

WCA

Air Flow Control Valve

BZW

Manifold Block

WHZ-MD

● Releasing Force and Dimensions when Operated by External Force

WKA is released by air pressure. It also can be operated by applying external force to the piston rod in such cases :

- Unable to supply air pressure directly
- Unable to secure sealing ability due to high temperature environment
- Operating manually

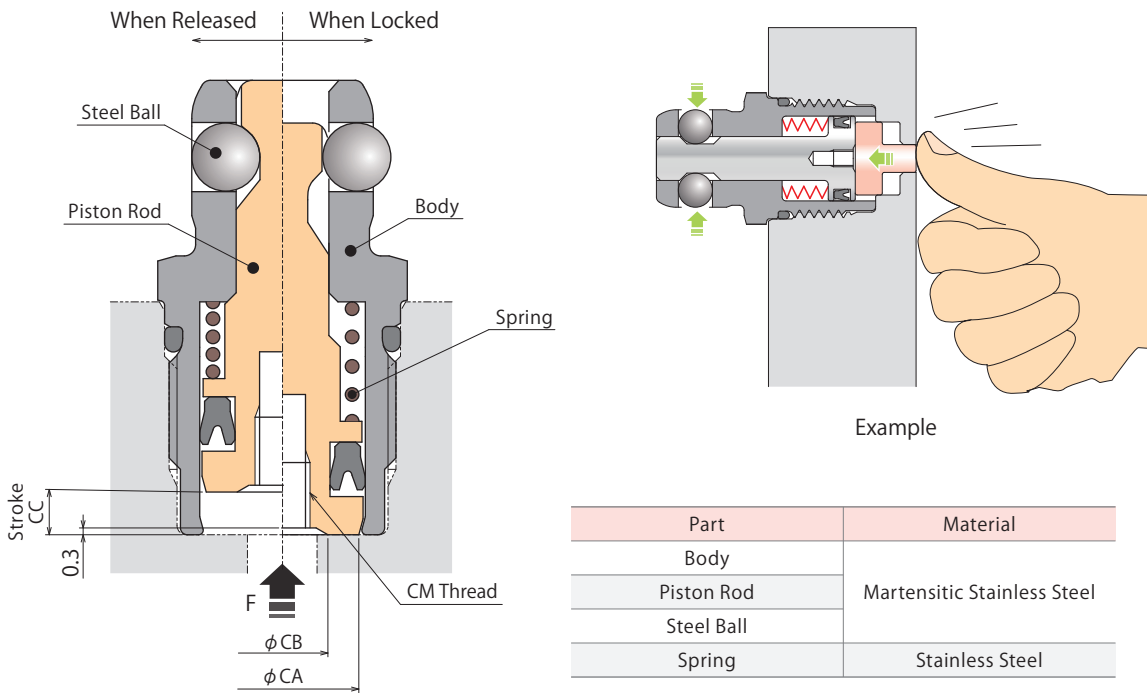

Part	Material
Body	Martensitic Stainless Steel
Piston Rod	
Steel Ball	
Spring	Stainless Steel

Model No.	WKA0060-□	WKA0080-□	WKA0100-□	WKA0120-□	WKA0160-□	
Required Releasing Force F N	10	10	12	12	17	
Max. Releasing Force F max ※1 N	40	40	60	60	100	
Dimensions mm	CA	6.8	6.8	8.5	10.5	13.5
	CB	4	4	5	6.5	9.5
	CC	1.8	2	2.3	2.7	3.2
	CM (Nominal× Pitch×Depth)	M2.5×0.45×3	M2.5×0.45×3	M3×0.5×4	M4×0.7×6	M5×0.8×8

Note :

※1. External force F (applying when releasing) should be more than the required releasing force and less than the maximum releasing force. External force greater than the maximum releasing force will damage the product.

● Backlash Prevention with O-ring (Reference)

There is a clearance between a workpiece hole and WKA when locked.

Simple backlash prevention is possible by mounting an o-ring to the neck part of WKA if necessary.

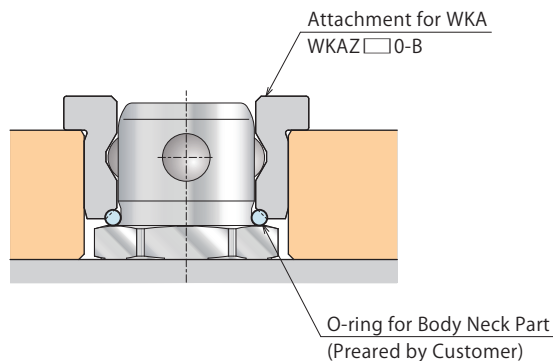

Model No.	WKA0060-□	WKA0080-□	WKA0100-□	WKA0120-□	WKA0160-□
O-ring for Body Neck Part	SS6.5 (NOK-made)	SS8 (NOK-made)	S10 (NOK-made)	S12 (NOK-made)	A568-015 ~ 016

● Cautions

● Notes for Design

- 1) Check Specifications
 - Please use each product according to the specifications.
 - The steel balls of WKA will be set within the cylinder by supplying air and it allows for loading and unloading the pallet (workpiece). By stopping air supply and releasing the supplied air, the steel balls will be expanded via internal spring to lock (prevent falling of) the pallet (fixture) or workpiece.
- 2) Do not use the product in the environment with cutting chips and coolant.
- 3) WKA fixes the workpiece hole with the steel balls (when locked).
 - There is a gap between the workpiece hole and cylinder when locked.
 - There is no locating function or pressing force applied to the reference surface.

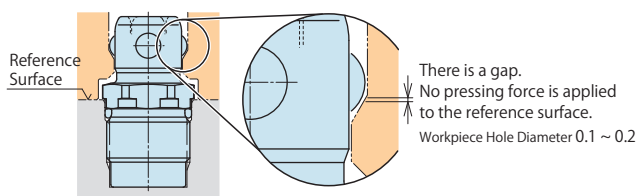

4) Workpiece Hole

- When temporarily locking the hole with the external dimensions other than shown on P.320, make sure to design so that the steel balls expand till the proper locked diameter. Otherwise, WKA can be released even with low pull-out force.

Appropriate Diameter when Locked

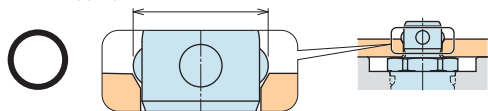

Appropriate Diameter when Locked

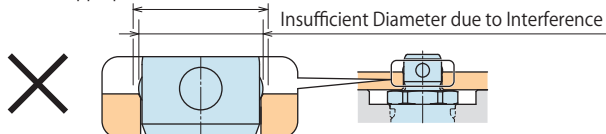

5) Mounting/Removing Pallet (Workpiece)

- If needed, please apply a guide pin (rough guide) separately to avoid increasing the force which exceeds allowable thrust load when mounting/ removing pallet (workpiece).
- The steel balls have only a slight expansion force when locking. If the pallet is heavy and/or the position of the product and pallet hole is dislocated, the steel balls may not expand properly. Please install a guide pin (rough guide) to ensure proper lock action.

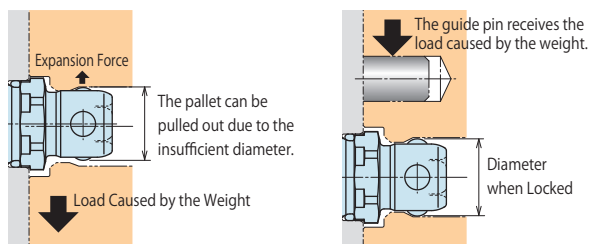

Supported by Guide Pin

● Installation Notes

- 1) Check the fluid to use.
 - Make sure to supply filtered clean dry air.
- 2) Preparation for Piping
 - The pipeline, piping connector and fixture circuits should be cleaned and flushed thoroughly. The dust and cutting chips in the circuit may lead to fluid leakage and malfunction.
 - There is no filter provided with this product for prevention of contaminants in the air circuit.
- 3) Applying Sealing Tape (Sealing Tape for Piping etc.)
 - Not required to apply sealing tape for the thread of the ball lock cylinder.
 - Wrap with tape 1 to 2 times following the screwing direction. Wrapping in the wrong direction will cause leaks and malfunction.
 - Pieces of the sealing tape can lead to air leaks and malfunction.
 - When piping, be careful that contaminant such as sealing tape does not enter in products.
- 4) Mounting the Product
 - When mounting, make sure there are no scratches or damage on the O-ring or the seals, and tighten the product according to the torque shown in the table below.

Model No.	Thread Size (mm)	Tightening Torque (N·m)
WKA0060 -□	M10×0.75	2.5
WKA0080 -□		
WKA0100 -□	M12×1	4.0
WKA0120 -□	M14×1	6.0
WKA0160 -□	M18×1.5	10.0

- Apply an adequate amount of grease to the O-ring.
 - If it is mounted under dry state, the O-ring may have twisting or be defective.
 - If it is tightened with an excessive torque, it may lead to malfunction or damage to the product.
- 5) Please avoid repetitive operation of WKA without a workpiece.

※ Please refer to P.715 for common cautions.

• Notes on Handling • Maintenance/Inspection • Warranty

Locating + Clamp

Locating

Hand + Clamp

Support

Valve + Coupler

Cautions + Others

Pallet Gripper
WVA

Locating Pin Clamp
SWP

High-Power Pull Stud Clamp
WPT
JES

FA Pneumatic Hole Clamp
WKH

Lifting Hole Clamp
SWJ

Ball Lock Cylinder
WKA

Pneumatic Robotic Hands
WPW-C
WPS-C
WPA
WPH
WPP
WPQ

Auto Switch Proximity Switch
JEP

High-Power Pneumatic Hole Clamp
SWE

High-Power Pneumatic Swing Clamp
WHE

High-Power Pneumatic Link Clamp
WCE

Pneumatic Hole Clamp
SWA

Pneumatic Swing Clamp
WHA

Double Piston Pneumatic Swing Clamp
WHD

Pneumatic Link Clamp
WCA

Air Flow Control Valve
BZW

Manifold Block
WHZ-MD

● Cautions

● Notes on Handling

- 1) It should be operated by qualified personnel.
 - The hydraulic machine and air compressor should be operated and maintained by qualified personnel.
- 2) Do not operate or remove the product unless the safety protocols are ensured.
 - ① The machine and equipment can only be inspected or prepared when it is confirmed that the safety devices are in place.
 - ② Before the product is removed, make sure that the above-mentioned safety devices are in place. Shut off the pressure and power source, and make sure no pressure exists in the air and hydraulic circuits.
 - ③ After stopping the product, do not remove until the temperature drops.
 - ④ Make sure there is no trouble/issue in the bolts and respective parts before restarting the machine or equipment.
- 3) Do not touch a clamp (cylinder) while it is working. Otherwise, your hands may be injured.

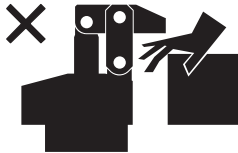

- 4) Do not disassemble or modify.
 - If the equipment is taken apart or modified, the warranty will be voided even within the warranty period.

● Maintenance and Inspection

- 1) Removal of the Machine and Shut-off of Pressure Source
 - Before removing the product, make sure that the safety devices are in place. Shut off the pressure and power source and make sure no pressure exists in the air and hydraulic circuits.
 - Make sure there is no trouble/issue in the bolts and respective parts before restarting.
- 2) Regularly clean the area around the piston rod and plunger.
 - If it is used when the surface is contaminated with dirt, it may lead to packing seal damage, malfunctioning, fluid leakage.

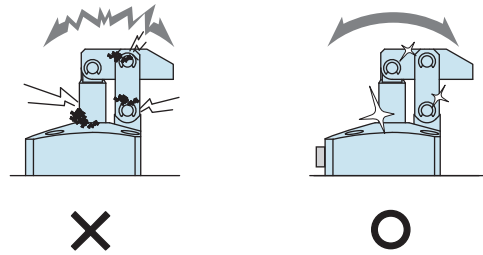

- 3) Regularly clean the reference surfaces (taper reference surface and seating surface) of locating products (SWT/SWQ/SWP/VRA/VRC/VX/VXE/VXF/WVS/VWH/VWM/VWK).
 - Locating products (except VRA/VRC/VX/VXE/VXF and SWR without air blow port) can remove contaminants with the cleaning function. When installing a workpiece or a pallet, make sure there are no contaminants such as thick sludge.
 - Continuous use with dirt on components will lead to locating failure, fluid leakage and malfunction.

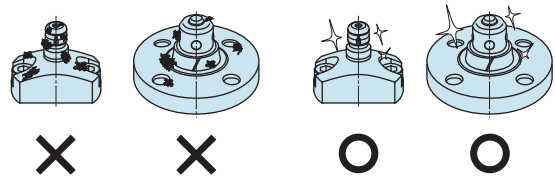

- 4) Regularly tighten pipe, mounting bolt, nut, snap ring, cylinder and others to ensure proper use.
- 5) Make sure the hydraulic fluid has not deteriorated.
- 6) Make sure there is a smooth action without an irregular noise.
 - Especially when it is restarted after left unused for a long period, make sure it can be operated correctly.
- 7) The products should be stored in the cool and dark place without direct sunshine or moisture.
- 8) Please contact us for overhaul and repair.

● Warranty

1) Warranty Period

- The product warranty period is 18 months from shipment from our factory or 12 months from initial use, whichever is earlier.

2) Warranty Scope

- If the product is damaged or malfunctions during the warranty period due to faulty design, materials or workmanship, we will replace or repair the defective part at our expense.

Defects or failures caused by the following are not covered.

- ① If the stipulated maintenance and inspection are not carried out.
- ② Failure caused by the use of the non-confirming state at the user's discretion.
- ③ If it is used or operated in an inappropriate way by the operator. (Including damage caused by the misconduct of the third party.)
- ④ If the defect is caused by reasons other than our responsibility.
- ⑤ If repair or modifications are carried out by anyone other than Kosmek, or without our approval and confirmation, it will void warranty.
- ⑥ Other caused by natural disasters or calamities not attributable to our company.
- ⑦ Parts or replacement expenses due to parts consumption and deterioration. (Such as rubber, plastic, seal material and some electric components.)

Damages excluding from direct result of a product defect shall be excluded from the warranty.

Locating
+
Clamp

Locating

Hand · Clamp

Support

Valve · Coupler

Cautions · Others

Cautions

Installation Notes

Maintenance/
Inspection

Warranty

Company Profile

Company Profile

Our Products

History

Index

Search by
Alphabetical Order

Sales Offices

Sales Offices

Sales Offices across the World

JAPAN HEAD OFFICE Overseas Sales	TEL. +81-78-991-5162	FAX. +81-78-991-8787
	KOSMEK LTD. 1-5, 2-chome, Murotani, Nishi-ku, Kobe-city, Hyogo, Japan 651-2241 〒651-2241 兵庫県神戸市西区室谷2丁目1番5号	
United States of America SUBSIDIARY KOSMEK (USA) LTD.	TEL. +1-630-620-7650	FAX. +1-630-620-9015
	650 Springer Drive, Lombard, IL 60148 USA	
MEXICO REPRESENTATIVE OFFICE KOSMEK USA Mexico Office	TEL. +52-442-161-2347	
	Av. Santa Fe #103 int 59 Col. Santa Fe Juriquilla C.P. 76230 Queretaro, Qro Mexico	
EUROPE SUBSIDIARY KOSMEK EUROPE GmbH	TEL. +43-463-287587	FAX. +43-463-287587-20
	Schleppeplatz 2 9020 Klagenfurt am Wörthersee Austria	
CHINA KOSMEK (CHINA) LTD. 考世美(上海)貿易有限公司	TEL. +86-21-54253000	FAX. +86-21-54253709
	Room601, RIVERSIDE PYRAMID No.55, Lane21, Pusan Rd, Pudong Shanghai 200125, China 中国上海市浦东新区浦三路21弄55号银亿滨江中心601室 200125	
INDIA BRANCH OFFICE KOSMEK LTD - INDIA	TEL. +91-9880561695	
	F 203, Level-2, First Floor, Prestige Center Point, Cunningham Road, Bangalore -560052 India	
THAILAND REPRESENTATIVE OFFICE KOSMEK Thailand Representation Office	TEL. +66-2-300-5132	FAX. +66-2-300-5133
	67 Soi 58, RAMA 9 Rd., Suanluang, Suanluang, Bangkok 10250, Thailand	
TAIWAN (Taiwan Exclusive Distributor) Full Life Trading Co., Ltd. 盈生貿易有限公司	TEL. +886-2-82261860	FAX. +886-2-82261890
	16F-4, No.2, Jian Ba Rd., Zhonghe District, New Taipei City Taiwan 23511 台湾新北市中和區建八路2號 16F-4 (遠東世紀廣場)	
PHILIPPINES (Philippines Exclusive Distributor) G.E.T. Inc, Phil.	TEL. +63-2-310-7286	FAX. +63-2-310-7286
	Victoria Wave Special Economic Zone Mt. Apo Building, Brgy. 186, North Caloocan City, Metro Manila, Philippines 1427	
INDONESIA (Indonesia Exclusive Distributor) PT. Yamata Machinery	TEL. +62-21-29628607	FAX. +62-21-29628608
	Delta Commercial Park I, Jl. Kenari Raya B-08, Desa Jayamukti, Kec. Cikarang Pusat Kab. Bekasi 17530 Indonesia	

Sales Offices in Japan

Head Office Osaka Sales Office Overseas Sales	TEL. 078-991-5162	FAX. 078-991-8787
	〒651-2241 兵庫県神戸市西区室谷2丁目1番5号	
Tokyo Sales Office	TEL. 048-652-8839	FAX. 048-652-8828
	〒331-0815 埼玉県さいたま市北区大成町4丁目81番地	
Nagoya Sales Office	TEL. 0566-74-8778	FAX. 0566-74-8808
	〒446-0076 愛知県安城市美園町2丁目10番地1	
Fukuoka Sales Office	TEL. 092-433-0424	FAX. 092-433-0426
	〒812-0006 福岡県福岡市博多区上牟田1丁目8-10-101	

Global Network

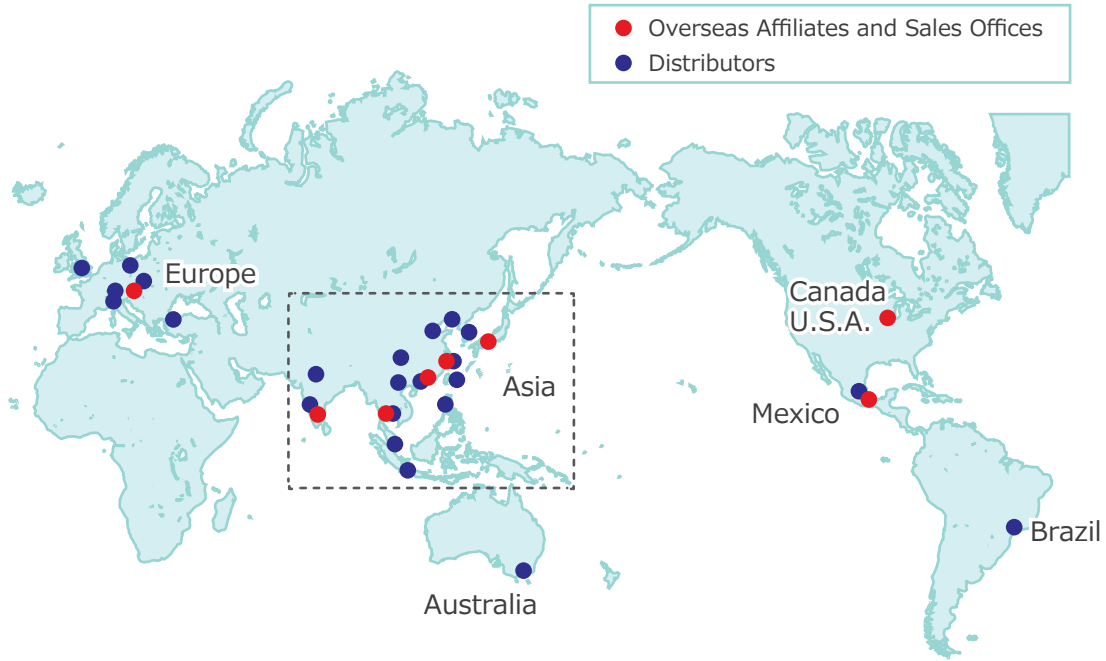

Asia Detailed Map



● FOR FURTHER INFORMATION ON UNLISTED SPECIFICATIONS AND SIZES, PLEASE CALL US.
● SPECIFICATIONS IN THIS CATALOG ARE SUBJECT TO CHANGE WITHOUT NOTICE.

