

Air Safety Valve

Model **BWS**



Expanded min. passage area of M5 thread models. Rc1/8 thread model newly added to the lineup.

Ultra-Compact and Light Air Pilot Check Valve

Suitable for cylinder position holding and workpiece fall prevention during robot transfer. **PAT.P.**

Weight

M3 Thread Model

9 grams

M5 Thread Model

14 grams

New

Rc1/8 Thread Model

37 grams

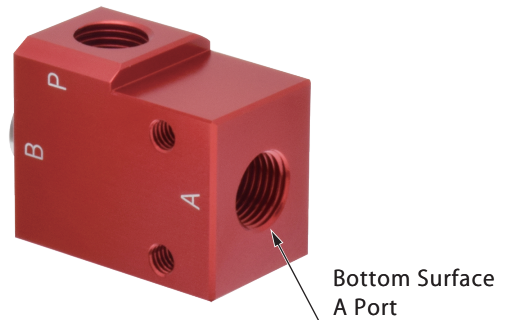

Bottom Surface
A Port

Even when air is stopped due to blackout, the Air Safety Valve maintains air pressure for long hours in a circuit. It is able to keep cylinder position and prevent workpiece fall. It is also highly reliable with built-in Soft Seal.

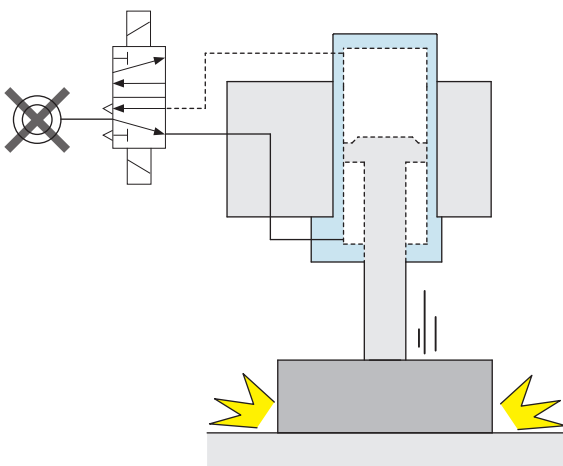

✗ The piston descends (falls) due to air source shut-off.

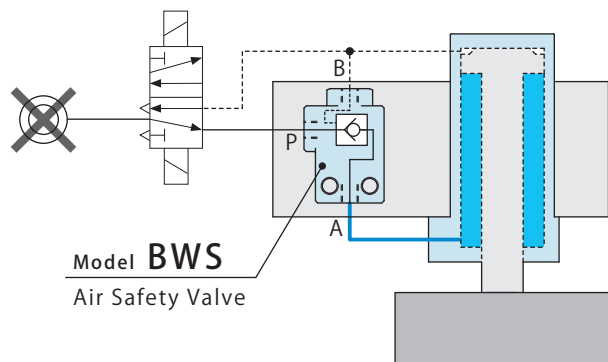

Model **BWS**
Air Safety Valve

○ Keeps the posture and prevents falling by maintaining pressure.

Application Example

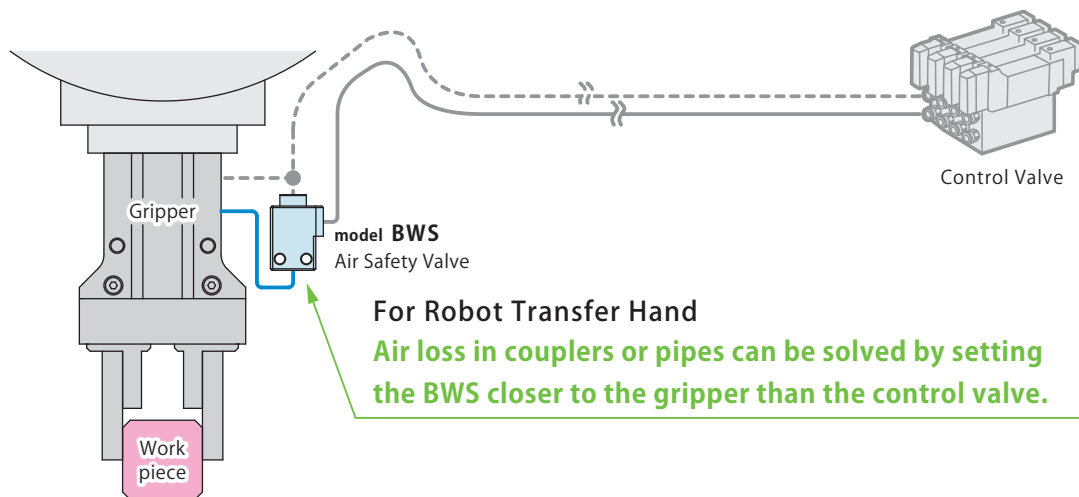

High Reliability with Soft Seal

Testing data of measuring elapsed time and pressure change when maintaining air pressure in A port. Sealing part is equipped with Soft Seal. It enables great pressure maintaining ability.

※ Testing data of single product with stable surrounding temperature.

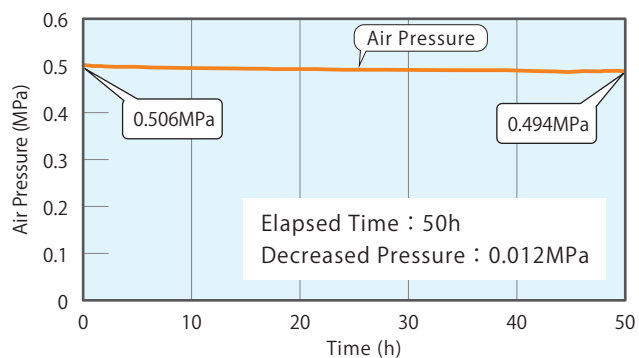

Model No. Indication

BWS 0 10 1

1 2

1 Body Size

03 : Port Thread Size M3

05 : Port Thread Size M5

10 : Port Thread Size Rc1/8[※]

※ The size of the pilot port is M5 thread.

2 Design No. ※ Revision Number.

0 : In case of **1**03 (When selecting the port thread size M3.)

1 : In case of **1**05, 10 (When selecting the port thread size M5 and Rc1/8.)

Circuit Symbol

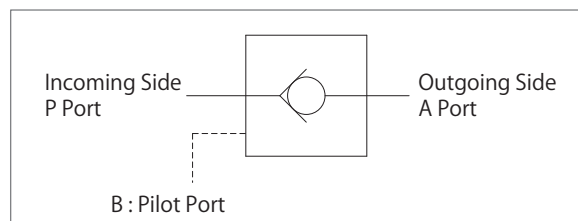

Specifications

Model No.		BWS0030	BWS0051	BWS0101
Thread Size of Each Port	mm	M3 Thread	M5 Thread	Rc1/8 Thread (The pilot port is M5 thread)
Operating Pressure	MPa	0.2 ~ 0.7		
Withstanding Pressure	MPa	1.5		
Min. Passage Area ^{※1}	mm ²	2.2	3.1	9.1
Cracking Pressure	MPa	0.03		
Pilot Pressure	MPa	Outgoing Side (A Port) : Maintaining Pressure×0.5 or more		
Operating Temperature	°C	0 ~ 70		
Usable Fluid		Dry Air		
Weight	g	9	14	37

Note :

※1. It shows the minimum passage area in the product. Please consider passage area of joint and others when designing circuits.

Locating + Clamp

Locating

Hand · Clamp

Support

Valve · Coupler

Cautions · Others

Air Safety Valve

BWS

Air Sequence Valve

BWD

Auto Coupler

JTA/JTB

JTC/JTD

JVA/JVB

JVC/JVD

JVE/JVF

JNA/JNB

JNC/JND

JLP/JLS

Leakless Coupler

JWC

Rotary Joint

JR

External Dimensions : BWS0101

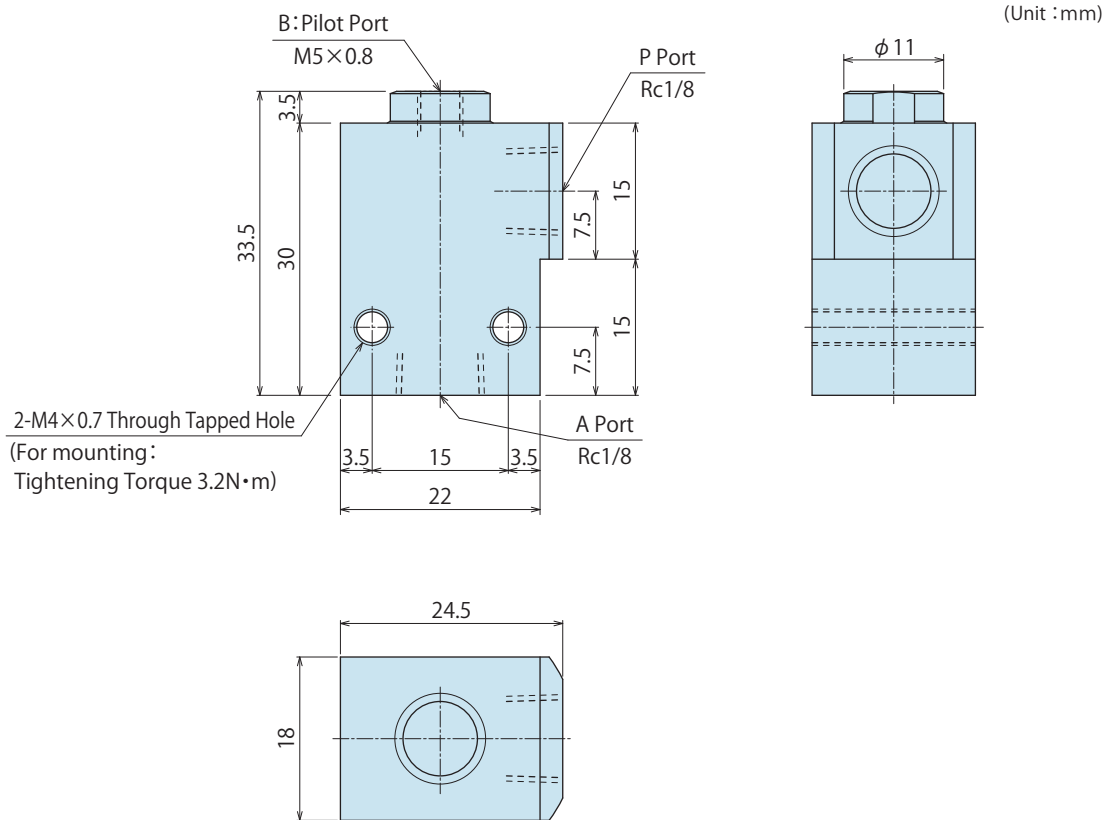

Cautions

- When using with a speed controller, set it between BWS and an actuator.
- Please supply filtered clean dry air.
Also, make sure no contaminants such as tips of sealing tape enter into the product as it affects a sealing ability.
Pressure cannot be maintained if contaminants stick to a check valve.
- This product is for maintaining pressure, and cannot be used under vacuum.

※ Please refer to P.715 for common cautions. · Notes on Handling · Maintenance/Inspection · Warranty

Locating
+
Clamp

Locating

Hand · Clamp

Support

Valve · Coupler

Cautions · Others

Air Safety Valve

BWS

Air
Sequence Valve

BWD

Auto Coupler

JTA/JTB

JTC/JTD

JVA/JVB

JVC/JVD

JVE/JVF

JNA/JNB

JNC/JND

JLP/JLS

Leakless Coupler

JWC

Rotary Joint

JR

● Cautions

● Notes on Handling

- 1) It should be operated by qualified personnel.
 - The hydraulic machine and air compressor should be operated and maintained by qualified personnel.
- 2) Do not operate or remove the product unless the safety protocols are ensured.
 - ① The machine and equipment can only be inspected or prepared when it is confirmed that the safety devices are in place.
 - ② Before the product is removed, make sure that the above-mentioned safety devices are in place. Shut off the pressure and power source, and make sure no pressure exists in the air and hydraulic circuits.
 - ③ After stopping the product, do not remove until the temperature drops.
 - ④ Make sure there is no trouble/issue in the bolts and respective parts before restarting the machine or equipment.
- 3) Do not touch a clamp (cylinder) while it is working. Otherwise, your hands may be injured.

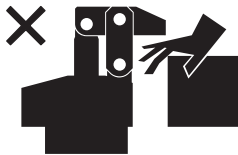

- 4) Do not disassemble or modify.
 - If the equipment is taken apart or modified, the warranty will be voided even within the warranty period.

● Maintenance and Inspection

- 1) Removal of the Machine and Shut-off of Pressure Source
 - Before removing the product, make sure that the safety devices are in place. Shut off the pressure and power source and make sure no pressure exists in the air and hydraulic circuits.
 - Make sure there is no trouble/issue in the bolts and respective parts before restarting.
- 2) Regularly clean the area around the piston rod and plunger.
 - If it is used when the surface is contaminated with dirt, it may lead to packing seal damage, malfunctioning, fluid leakage.

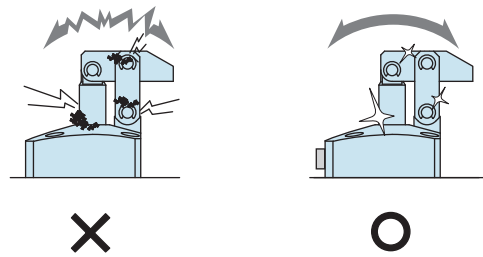

- 3) Regularly clean the reference surfaces (taper reference surface and seating surface) of locating products (SWT/SWQ/SWP/VRA/VRC/VX/VXE/VXF/WVS/VWH/VWM/VWK).
 - Locating products (except VRA/VRC/VX/VXE/VXF and SWR without air blow port) can remove contaminants with the cleaning function. When installing a workpiece or a pallet, make sure there are no contaminants such as thick sludge.
 - Continuous use with dirt on components will lead to locating failure, fluid leakage and malfunction.

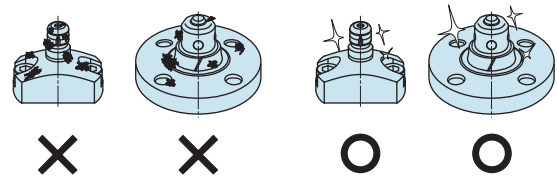

- 4) Regularly tighten pipe, mounting bolt, nut, snap ring, cylinder and others to ensure proper use.
- 5) Make sure the hydraulic fluid has not deteriorated.
- 6) Make sure there is a smooth action without an irregular noise.
 - Especially when it is restarted after left unused for a long period, make sure it can be operated correctly.
- 7) The products should be stored in the cool and dark place without direct sunshine or moisture.
- 8) Please contact us for overhaul and repair.

● Warranty

1) Warranty Period

- The product warranty period is 18 months from shipment from our factory or 12 months from initial use, whichever is earlier.

2) Warranty Scope

- If the product is damaged or malfunctions during the warranty period due to faulty design, materials or workmanship, we will replace or repair the defective part at our expense.

Defects or failures caused by the following are not covered.

- ① If the stipulated maintenance and inspection are not carried out.
- ② Failure caused by the use of the non-confirming state at the user's discretion.
- ③ If it is used or operated in an inappropriate way by the operator. (Including damage caused by the misconduct of the third party.)
- ④ If the defect is caused by reasons other than our responsibility.
- ⑤ If repair or modifications are carried out by anyone other than Kosmek, or without our approval and confirmation, it will void warranty.
- ⑥ Other caused by natural disasters or calamities not attributable to our company.
- ⑦ Parts or replacement expenses due to parts consumption and deterioration. (Such as rubber, plastic, seal material and some electric components.)

Damages excluding from direct result of a product defect shall be excluded from the warranty.

Locating
+
Clamp

Locating

Hand · Clamp

Support

Valve · Coupler

Cautions · Others

Cautions

Installation Notes

Maintenance/
Inspection

Warranty

Company Profile

Company Profile

Our Products

History

Index

Search by
Alphabetical Order

Sales Offices

Sales Offices

Sales Offices across the World

JAPAN HEAD OFFICE Overseas Sales	TEL. +81-78-991-5162	FAX. +81-78-991-8787
	KOSMEK LTD. 1-5, 2-chome, Murotani, Nishi-ku, Kobe-city, Hyogo, Japan 651-2241 〒651-2241 兵庫県神戸市西区室谷2丁目1番5号	
United States of America SUBSIDIARY KOSMEK (USA) LTD.	TEL. +1-630-620-7650	FAX. +1-630-620-9015
	650 Springer Drive, Lombard, IL 60148 USA	
MEXICO REPRESENTATIVE OFFICE KOSMEK USA Mexico Office	TEL. +52-1-55-3044-9983	
	Av. Santa Fe 103, Int. 59, col. Santa Fe Juriquilla, Queretaro, QRO, 76230, Mexico	
EUROPE SUBSIDIARY KOSMEK EUROPE GmbH	TEL. +43-463-287587	FAX. +43-463-287587-20
	Schleppeplatz 2 9020 Klagenfurt am Wörthersee Austria	
CHINA KOSMEK (CHINA) LTD. 考世美(上海)貿易有限公司	TEL. +86-21-54253000	FAX. +86-21-54253709
	Room601, RIVERSIDE PYRAMID No.55, Lane21, Pusan Rd, Pudong Shanghai 200125, China 中国上海市浦东新区浦三路21弄55号银亿滨江中心601室 200125	
INDIA BRANCH OFFICE KOSMEK LTD - INDIA	TEL. +91-9880561695	
	4A/Old No:649, Ground Floor, 4th D cross, MM Layout, Kavalbyrasandra, RT Nagar, Bangalore -560032 India	
THAILAND REPRESENTATIVE OFFICE KOSMEK Thailand Representation Office	TEL. +66-2-300-5132	FAX. +66-2-300-5133
	67 Soi 58, RAMA 9 Rd., Phatthanakan, Suanluang, Bangkok 10250, Thailand	
TAIWAN (Taiwan Exclusive Distributor) Full Life Trading Co., Ltd. 盈生貿易有限公司	TEL. +886-2-82261860	FAX. +886-2-82261890
	16F-4, No.2, Jian Ba Rd., Zhonghe District, New Taipei City Taiwan 23511 台湾新北市中和區建八路2號 16F-4 (遠東世紀廣場)	
PHILIPPINES (Philippines Exclusive Distributor) G.E.T. Inc, Phil.	TEL. +63-2-310-7286	FAX. +63-2-310-7286
	Victoria Wave Special Economic Zone Mt. Apo Building, Brgy. 186, North Caloocan City, Metro Manila, Philippines 1427	
INDONESIA (Indonesia Exclusive Distributor) PT. Yamata Machinery	TEL. +62-21-29628607	FAX. +62-21-29628608
	Delta Commercial Park I, Jl. Kenari Raya B-08, Desa Jayamukti, Kec. Cikarang Pusat Kab. Bekasi 17530 Indonesia	

Sales Offices in Japan

Head Office Osaka Sales Office Overseas Sales	TEL. 078-991-5162	FAX. 078-991-8787
	〒651-2241 兵庫県神戸市西区室谷2丁目1番5号	
Tokyo Sales Office	TEL. 048-652-8839	FAX. 048-652-8828
	〒331-0815 埼玉県さいたま市北区大成町4丁目81番地	
Nagoya Sales Office	TEL. 0566-74-8778	FAX. 0566-74-8808
	〒446-0076 愛知県安城市美園町2丁目10番地1	
Fukuoka Sales Office	TEL. 092-433-0424	FAX. 092-433-0426
	〒812-0006 福岡県福岡市博多区上牟田1丁目8-10-101	

Global Network

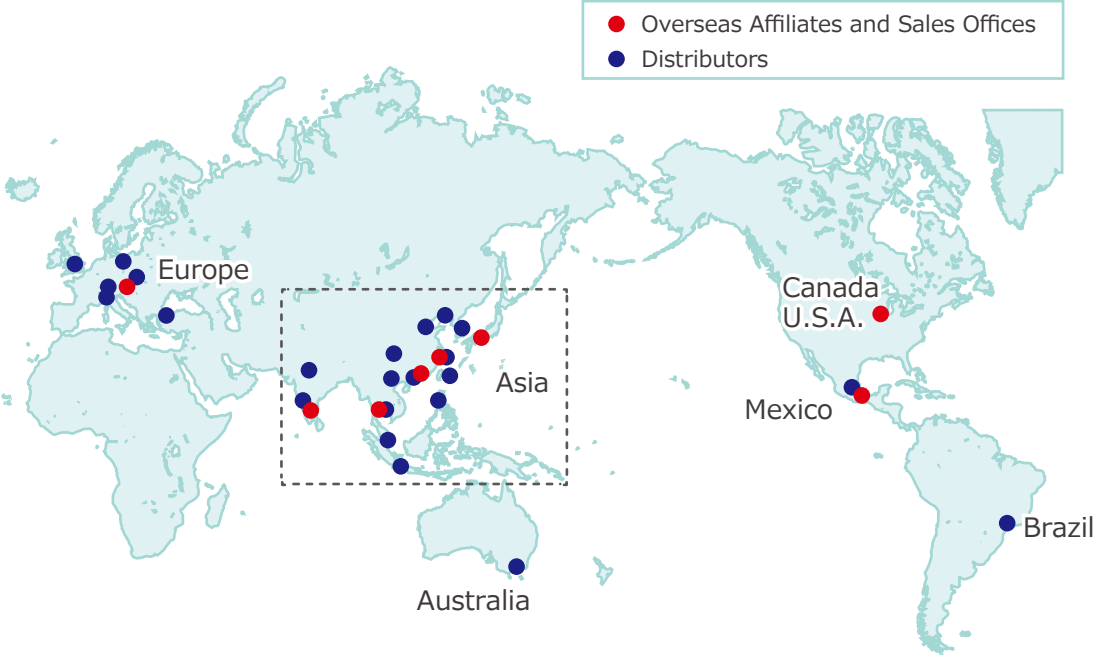

Asia Detailed Map



● FOR FURTHER INFORMATION ON UNLISTED SPECIFICATIONS AND SIZES, PLEASE CALL US.
● SPECIFICATIONS IN THIS CATALOG ARE SUBJECT TO CHANGE WITHOUT NOTICE.

