

KBC
BEARINGS

Rolling Bearings



Schaeffler Korea Corporation
Catalogue GB 41 500 EA

Bearing Standards

	page
160	Deep Groove Ball Bearing 148
28TAG	One-Way Thrust Ball Bearing for Automobile King-Pins 210
302 • 303	Tapered Roller Bearing 180
320 • 322 • 323	Tapered Roller Bearing 180
330 • 332	Tapered Roller Bearing 180
38KW	Inch Series Tapered Roller Bearing 190
511	One-Way Thrust Ball Bearing 210
60 • 62 • 63	Deep Groove Ball Bearing 140
69	Deep Groove Ball Bearing 142
72 • 73 • 74	Single-Row Angular Contact Ball Bearing 164
99	Deep Groove Ball Bearing 142
AT	Deep Groove Ball Bearing for Automobile Generators 142
B25	Deep Groove Ball Bearing, Special Sizes 146
BR	Deep Groove Ball Bearing, Special Sizes 140
BS	Single-Row Angular Contact Ball Bearing, with seal type for high speed 164
BW	Water Pump Bearing, Ball-Ball Type 216
CLT	One-Way Clutch Combined Bearing 220
DT	Double-Row Tapered Roller Bearing 196
EC	Deep Groove Ball Bearing for Creep Elimination 140
F2	Flanged Housing 206
H	Inch Series Tapered Roller Bearing 192
HC	Deep Groove Ball Bearing for High Load Carrying Capacity 142
HM	Inch Series Tapered Roller Bearing 188
JL • JLM	Inch Series Tapered Roller Bearing 190
K	Needle Roller Bearing 200
L • LM	Inch Series Tapered Roller Bearing 188
M	Inch Series Tapered Roller Bearing 188
P2	Plummer Block Housing 206
RW	Water Pump Bearing, Ball-Roller Type 216
S	Inch Series Tapered Roller Bearing 190
S	One-Way Thrust Ball Bearing for Automobile King-Pins 210
SA	Single-Row Angular Contact Ball Bearing, Special Sizes 166
SDA0	Double-Row Angular Contact Ball Bearing, Special Sizes, Split Inner 174
SDA9	Double-Row Angular Contact Ball Bearing, Special Sizes, Combined Inner/Outer Ring Type 172
SM	Single-Row Angular Contact Ball Bearing for High Rotating Speed 164
TR	Tapered Roller Bearing, Special Sizes 180
UB2	Unitized(Insert) Ball Bearing 206
UC2	Unitized(Insert) Ball Bearing 206
UCF2 • UCFC2 • UCFL2	Flanged Bearing Unit 206
UCP2	Plummer Block Unit 206

Rolling Bearings

Ball Bearing · Roller Bearing · Special Bearing

Catalogue GB 41 500 EA

Some of the contents in this Catalogue could become outdated by some newest technical advancement or the changes in our production items. Although we have been putting our very best effort to avoid any errors or omissions, there still might be some left to be corrected. However, Schaeffler Korea Corporation shall not be responsible for any errors or omissions in this Catalogue, if there is any. Please be kind enough to contact us if you find any errors or omissions.

© The copy right for this Catalogue belongs to Schaeffler Korea Corporation
Copying of all or a part of this Catalogue without a prior written consent from Schaeffler Korea Corporation is strictly prohibited

Contents

	Page
1. Bearing types	10
1-1 Sliding Bearing and Rolling Bearing	10
1-2 Classification of bearings	11
2. Selection of Bearings	12
2-1 Description	12
2-2 Selection of Bearing Type	14
2-2-1 Comparisons of Different Bearings	
2-2-2 Permissible Mounting Space	
2-2-3 Magnitude and Direction of Load	
2-2-4 Precision	
2-2-5 Rotating Speed	
2-2-6 Misalignment of inner and outer rings	
2-2-7 Noise and Torque	
2-2-8 Rigidity	
2-2-9 Mounting and Dismounting	
2-3 Bearing Arrangements	20
2-3-1 Locating Bearing and Floating Bearing	
2-3-2 Examples of Bearing Arrangement	
3. Rated Load and Bearing Life	23
3-1 Bearing Life	23
3-2 Basic Rating Life and Dynamic Load Rating	23
3-3 Adjusted Rating Life	27
3-3-1 Reliability Factor a_1	
3-3-2 Material Factor a_2	
3-3-3 Operating Condition Factor a_3	
3-4 Operating Machine and Required Life	28
3-5 Basic Static Load Rating	29
3-6 Permissible Static Equivalent Load	29
4. Calculation of Bearing Load	30
4-1 Load Applied to Shaft	30
4-1-1 Load Factor	
4-1-2 Load Applied to Spur Gear	
4-1-3 Loads Applied to Chain and Belt	
4-2 Average Load	32
4-2-1 Fluctuation by Stages	
4-2-2 Rotating and Static Loads	
4-2-3 Continuous Fluctuation	
4-3 Equivalent Load	34
4-3-1 Dynamic Equivalent Load	
4-3-2 Static Equivalent Load	
4-3-3 Load Calculation for Angular Contact Ball Bearing and Tapered Roller Bearing	

Contents

	Page
5. Permissible Bearing Speed	36
5-1 Correction of Permissible Speed	36
5-2 Permissible Speed for Bearings with Rubber Contact Seal	38
6. Boundary Dimensions and Designated Numbering System	39
6-1 Selection of Dimensions	39
6-2 Boundary Dimensions	39
6-3 Designated Numbering System	58
6-3-1 Purpose	
6-3-2 Composition	
6-3-3 Designated Numbering System for Inch Series Tapered Roller Bearings	
7. Dimensional and Running Accuracy of Bearings	64
7-1 Specification of Tolerance Classes	64
7-2 Definition of Dimensional and Running Accuracy	64
7-2-1 Dimensional Accuracy	
7-2-2 Running Accuracy	
8. Fits	84
8-1 Importance of Correct Fits	84
8-2 Selection of Fits	84
8-3 Calculation of Fitting Tolerances	86
8-3-1 Minimum Required Interference	
8-3-2 Maximum Interference	
8-4 Recommended Fits	89
9. Bearing Clearance	94
9-1 Selection of Bearing Internal Clearance	94
9-2 Bearing Clearance Variations	95
9-2-1 Reduction of the Radial Clearance by Means of Temperature Differences	
9-2-2 Reduction of Radial Clearance by Means of Tight Fits	
10. Bearing Preload	96
10-1 Purpose of Preload	96
10-2 Methods and Characteristics of Preload	96
10-3 Preload and Rigidity of Bearing	98
10-4 Evaluation of Preload	99
10-5 Controlling of Preload	99
11. Design of Surrounding Structure	100
11-1 Precision of Shaft and Housing	100
11-2 Sealing	101
11-2-1 Non-Contact Seals	
11-2-2 Contact Seals	
12. Lubrication	104

12-1 Purpose of Lubrication	104
12-2 Lubrication Methods	104
12-3 Grease Lubrication	104
12-3-1 Lubrication Grease	
12-3-2 Polymer Grease	
12-3-3 Injection of Grease	
12-3-4 Properties of Grease	
12-4 Oil Lubrication	110
12-4-1 Lubrications	110
12-4-2 Oil Lubrication Methods	111
13. Bearing Material	113
13-1 Material of Ring and Rolling Element	113
13-2 Cage Material	
14. Handling of Bearings	119
14-1 Storage Precautions	119
14-2 Mounting of Bearings	120
14-2-1 Mounting of Cylindrical Bore Bearings	
14-2-2 Mounting of Tapered Bore Bearings	
14-3 Bearing Performance Test	122
14-3-1 Manual Operation Test	
14-3-2 Operation Test with Power On	
14-4 Dismounting of Bearings	123
14-4-1 Dismounting of Cylindrical Bore Bearings	
14-4-2 Dismounting of Tapered Bore Bearings	
14-4-3 Dismounting of Outer Rings	
14-5 Compression or extraction Forces	126
15. Damage to Bearings and Preventive Measures	127
16. Packages	132
Deep Groove Ball Bearings	136
Single-Row Angular Contact Ball Bearings	158
Double-Row Angular Contact Ball Bearings	168
Single-Row Tapered Roller Bearings	176
Double-Row Tapered Roller Bearings	194
Needle Roller Bearings	198
Unit Bearings	202
Thrust Ball Bearings	208
Water Pump Bearings	212
Single Direction Solid Clutch Bearings	218
Ceramic Bearings	222
Vacuum Bearings	224
Appendix	227

1. Bearing types

1. Bearing types

1-1 Sliding Bearing and Rolling Bearing

Bearings are used as a mechanical component to transfer the power and to move a certain part, and this is done by utilizing the small frictional force of the bearings, which makes them rotate easily (or move in one direction easily), all the while withstanding the force and weight load acting against them.

Bearings can be classified into two major groups, namely, sliding bearings and rolling bearings, depending on their friction type.

Three types of bearings are shown in Fig. 1-1, and (a) Sliding Bearings represent both the self-lubricating bearings made of special material that requires no lubricants between Shaft A and Bearing B and the ones made of porous material to be soaked with lubricants, and (b) Sliding Bearing represents both the hydrodynamic lubrication bearings requiring lubricants that automatically form the oil film in the space between Shaft A and Bearing B by way of rotating the shaft and the hydrostatic lubrication bearings requiring lubricants that elevate the rotating shaft by providing the pressurized lubricant from outside. Recently, magnetic bearings that elevate the rotating shaft by using both attraction and repulsion forces of the magnet have been introduced, and the air bearings that use the air as lubricant instead of oil are also the newest development.

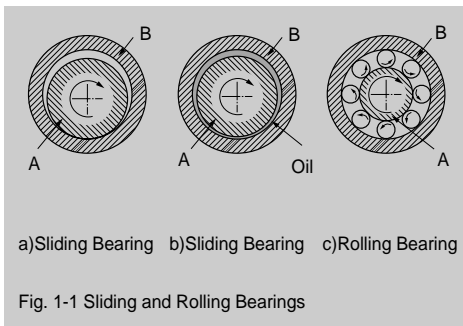

There are two types of Rolling Bearings. (c) Ball Bearing has balls between Inner Ring A and Outer Ring B, and Roller Bearing has rollers instead of balls. Either balls or rollers of rolling bearings serve the same purpose as the lubricating oil in the sliding bearings. However rolling bearings still require some help from lubricating oil. Although the movement of rolling bearing consists mainly of rolling action, it still involves some sliding action in reality. That is why some lubricant is needed for reduction of friction, and also for withstanding the high speed rotation.

Rolling bearings have some advantages as listed below, compared with the sliding bearings.

- Because bearing specifications are standardized internationally, most rolling bearings are interchangeable, and could be replaced easily with the ones made by different manufacturers.
- Surrounding structures of a bearing could be simplified.
- Easy to diagnose and maintain
- Has small starting torque, and the difference between starting torque and operating torque is very small.
- Generally, both radial and axial loads can be applied to the rolling bearings at the same time.
- Comparatively easy to be used even under the high or low temperatures.
- The rigidity of bearings could be increased by applying preload.



























Because this Catalogue contains description only on the rolling bearings, the words, "rolling bearings", in the rest of this Catalogue have been simply written down as the "bearings", unless it is necessary to compare them with sliding bearings.

1-2 Classification of Bearings

Bearings can be classified into Ball Bearings and Roller Bearings depending on the types of rolling elements, or into Radial Bearings and Thrust Bearings depending on the directions of the loads that could be mainly supported by them.

Radial and Thrust Bearings are generally classified depending on the ring shapes, contact angles, or shape of rolling elements, as shown in the Table 1-1 below, and they can be also classified depending on their various specific purpose and usage.

Table 1-1 Classification of Bearings (Items written in bold characters are the ones currently produced by KBC)

Radial Bearing	Ball Bearing	Single-Row	Deep Groove Ball Bearing			
			Single-Row Angular Contact Ball Bearing			
			Unit Bearing			
		Double-Row	Double-Row Angular Contact Ball Bearing			
			Self-Aligning Ball Bearing			
	Roller Bearing	Single-Row	Cylindrical Roller Bearing			
			Tapered Roller Bearing			
			Needle Roller Bearing			
			Double-Row	Double-Row Cylindrical Roller Bearing		
				Spherical Roller Bearing		
Thrust Bearing	Ball Bearing	Single-Row	Flat Washer Thrust Ball Bearing (One Way, Two Ways)			
			Self-Aligning Housing Washer Thrust Ball Bearing (One Way, Two Ways)			
			Thrust Angular Contact Ball Bearing (One Way, Two Ways)			
			Thrust Cylindrical Roller Bearing			
			Thrust Needle Roller Bearing			
	Roller Bearing	Single-Row	Thrust Spherical Roller Bearing			

2. Selection of Bearings

2. Selection of Bearings

2-1. Description

The main points to consider when selecting bearings are longevity, reliability, and price. Furthermore, customers' demands for more versatile and functional bearings are increasing more than ever before. Therefore, when selecting bearings, various aspects have to be considered to select the most appropriate ones for the specific purposes.

The followings are the general procedures that are taken in selecting the most appropriate bearings. First of all, all the operating and surrounding conditions need to be analyzed. These have to be taken into considerations in each of the

following stages of bearing selection procedures.

- Examination of bearing type
- Examination of bearing arrangement
- Examination of bearing dimension
- Examination of detailed specifications of bearing (precision, clearance & preload, cage type, lubricant, etc.)

When selecting the proper bearings for new machines or ones used under special settings and conditions, more complex calculations and designing(not shown in this catalogue) may be necessary. It is recommended to contact us when you are in these kinds of situations.

An example of general procedures in selecting the bearings is shown in Table 2-1 below.

Table 2-1 An example of general procedures in selecting the bearings

Analyzing of Operating and Surrounding Conditions

Functions & structure of machine
 Operating conditions(Load, speed, mounting space, temperature, surrounding conditions, shaft arrangement, rigidity of mounting seats)
 Required conditions(Longevity, precision, noise, friction & operating temperature, lubrication & maintenance, mounting & dismounting)
 Economical Viability(Price, quantity, delivery)

Selection of Bearing Type

Permissible mounting space
 Magnitude and direction of load
 Existence of vibration and impact
 Rotating speed
 Tilting of inner/outer ring
 Bearing arrangement
 Noise, torque
 Rigidity
 Mounting & dismounting
 Marketability, economical viability

Refer to pages, 18, 39~53
 Refer to pages, 14~17, 18, 29~35
 Refer to pages, 14~17, 19, 36~38
 Refer to pages, 14~17, 19
 Refer to pages, 14~17, 20~22
 Refer to pages, 14~17, 19
 Refer to pages, 14~17, 19
 Refer to pages, 19



































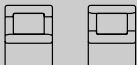



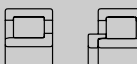



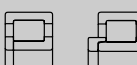







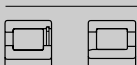

<p>Selection of Bearing Dimension</p>	<p>Required design life Dynamic/Static Equivalent Loads Rotating Speed Index of static stressing Permissible axial load Permissible mounting Space</p>	<p>Refer to pages, 23–29 Refer to pages, 34–35 Refer to pages, 14–17, 36–38 Refer to pages, 29 Refer to pages, 18, 39–53</p>
<p>Selection of Bearing Precision</p>	<p>Running accuracy of Rotating Shaft Rotating Speed Torque variation</p>	<p>Refer to pages, 64–83 Refer to pages, 19 Refer to pages, 19</p>
<p>Selection of Bearing Clearance</p>	<p>Fitting Temperature Differences between Inner and Outer Rings Tilting of inner/outer Rings Preload</p>	<p>Refer to pages, 84–93 Refer to pages, 94 Refer to pages, 96–99</p>
<p>Selection of Cage Type and Materials</p>	<p>Rotating Speed Noise Operating Temperatures Lubricating Method Vibration/Impact</p>	<p>Refer to pages, 19, 86 Refer to pages, 86 Refer to pages, 86</p>
<p>Selection of Lubricating Method/Lubricant/Sealing Method</p>	<p>Operating Temperatures Rotating Speed Lubricating Method Sealing Method Maintenance/inspection</p>	<p>Refer to pages, 102 Refer to pages, 102–112 Refer to pages, 104–112 Refer to pages, 101–103 Refer to pages, 104, 107–108</p>
<p>Review of mounting and dismounting</p>	<p>Dimensions of mating components Mounting/dismounting Methods Equipments and Tools</p>	<p>Refer to pages, 100 Refer to pages, 119–126 Refer to pages, 119–126</p>

2. Selection of Bearings

2-2 Selection of Bearing Type

2-2-1 Comparisons of Different Bearings

Table 2-2 is the comparative table showing all main characteristics of bearings.

Table 2-2 Comparative Table of Bearings		Characteristics				
Compatibility						
	Excellent		Limited			
	Good		Not compatible / Not allowed			
	Fair / Applicable					
Bearing Types		Radial Load Carrying Capacity	Axial Load Carrying Capacity (both directions)	Length compensation within the bearing	Length compensation by loose fitting	
Deep Groove Ball Bearing						
Angular Contact Ball Bearing						
Double-Row Angular Contact Ball Bearing						
Self-Aligning Ball Bearing						
Cylindrical Roller Bearing NU, N						
NJ, NU + HJ						
NUP, NJ + HJ						
NN						
NCF, NJ23VH						
NNC, NNF						

← Single bearing or tandem arranged bearings

a) Assembled in couples















b) Small axial load

Separable Bearing	Compensation for Misalignment	Precision	High Speed Suitability	Low Noise Level	Tapered Bore	Sealing in One Side/Both Sides	Rigidity	Low Friction	Locating Bearing	Floating Bearing
×	△	○	☆	☆	×	☆	○	☆	◎	○
×	×	☆	☆ _c	◎	×	×	◎ _a	◎	☆ _a	○ _a
○	×	○	○	△	×	○	◎	○	◎	○
×	☆	×	◎	△	☆ _d	☆	△	◎	○	○
☆	△	◎	☆	○	○	×	◎	◎	×	☆
☆	△	○	◎ _b	△	×	×	◎	◎ _b	○	○
☆	△	○	◎ _b	△	×	×	◎	◎ _b	◎	△
☆	×	☆	☆	○	☆	×	☆	◎	×	☆
○	△	×	×	×	×	×	☆	×	○	○
×	×	×	×	×	×	○	☆	×	○	○

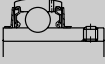
c) Applications limited when assembled in couples

d) Using adapter sleeve or withdrawal sleeve

2. Selection of Bearings

Compatibility				Characteristics				
	Excellent		Limited	Radial Load Carrying Capacity	Axial Load Carrying Capacity (both directions)	Length compensation within the bearing	Length compensation by loose fitting	
	Good		Not compatible / Not allowed					
	Fair / Applicable							
Bearing Types								
Tapered Roller Bearing				★	★ ←	×	○ _a	
Spherical Roller Bearing				★	◎	×	○	
Needle Roller Bearing				★	×	★	×	
Unit Bearing				◎	○	△	△	
Thrust Ball Bearing				×	◎ ←	×	×	
				×	◎	×	×	
Thrust Angular Contact Ball Bearing				△	◎ ←	×	×	
				×	◎	×	×	
Thrust Cylindrical Roller Bearing				×	★ ←	×	×	
Thrust Spherical Roller Bearing				△	★ ←	×	×	

← Single bearing or for tandem arranged bearings

a) Assembled in couples

c) Applications limited when assembled in couples
d) Using adapter sleeve or withdrawal sleeve

Separable Bearing	Compensation for Misalignment	Precision	High Speed Suitability	Low Noise Level	Tapered Bore	Sealing in One Side/Both Sides	Rigidity	Low Friction	Locating Bearing	Floating Bearing
☆ _f	△	◎	○ _c	△	×	×	☆ _a	○	☆ _a	△ _a
×	☆	×	○	△	☆ _d	○	◎	○	◎	○
☆	×	×	×	×	×	×	☆	×	×	☆
×	○ _e	×	△	×	×	☆	○	×	○	×
☆	○ _e	◎	○	△	×	×	○	○	○	×
☆	○ _e	×	△	×	×	×	○	△	○	×
×	△	☆	◎ _c	△	×	×	◎ _a	○	☆ _a	×
☆	×	☆	☆	△	×	×	☆	○	☆	×
☆	×	○	△	×	×	×	◎	×	◎	×
☆	☆	×	△	×	×	×	◎	△	◎	×

e) Thrust ball bearing with insert bearing and seating washer, installed on the spherical housing, can be corrected misalignment when assembling

f) Separation is limited in case of sealed types

g) Applicable in case of sealed types

2. Selection of Bearings

2-2-2 Permissible Mounting Space

Because the mounting space for bearing can be usually pre-determined, all of bore and outer diameters and widths of the bearing can be also easily decided at first. However, when designing a machine or an equipment, it is common to first decide the size of the shaft, and then the permissible space for the bearing in accordance with the diameter of the shaft, before selecting the appropriate bearing. Also, in most cases, the bore diameter of bearings is specifically designated, whereas the dimensions of outer diameter and width are usually proposed roughly. Therefore, bearings are usually chosen based on their inner diameters.

Bearings of various types and dimensions with same bore diameters are provided, therefore the most appropriate ones have to be carefully chosen after examining all the possibilities. Main dimensions

for each dimension group are shown in Chapter 6. Main Dimensions and Nominal Symbols on page 39.

2-2-3 Magnitude and Direction of Load

Loads applied to a bearing vary greatly depending on their magnitude, directions, or characteristics. The capacity for bearing to carry loads is called a load carrying capacity, and this load carrying capacity can be divided into radial load carrying capacity and axial load carrying capacity.

The radial and axial load carrying capacities for some radial and thrust bearings are shown in Fig. 2-1 and Fig. 2-2. When bearings of same dimension are compared, roller bearings have bigger load carrying capacity than ball bearings, and they can also withstand greater impact load than ball bearings.

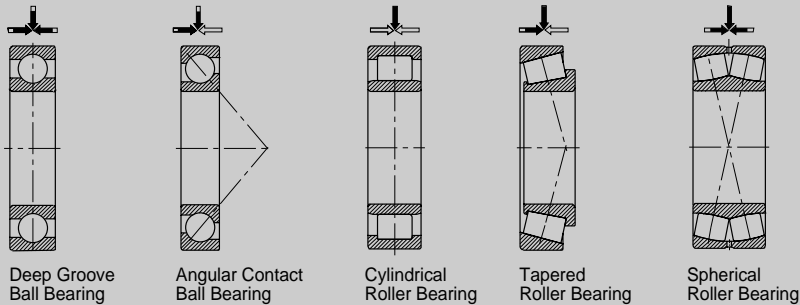

Fig. 2-1 Load Carrying Capacity of Radial Bearing

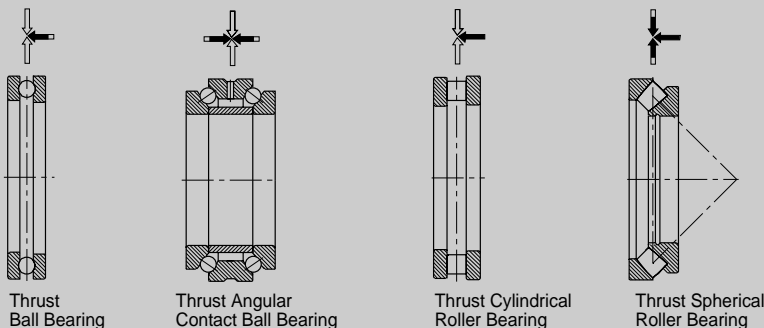

Fig. 2-2 Load Carrying Capacity of Thrust Bearing

2-2-4 Precision

Precision and running accuracy of KBC bearings comply with ISO 1132 and KS B 2014. In most cases, Tolerance Class "0" is more than enough to satisfy all the general requirements for the bearings. However, the bearings of higher Tolerance Classes have to be used when the specific performance requirements have to be met or when they are used under the special operating conditions, as shown below.

- When higher degree of precision for rotating component is required
(Eg.: Main shaft of machine tool, VTR drum spindle, etc.)
- When bearing is rotating at a very high speed
(Eg.: High frequency spindle, supercharger, etc.)
- When the friction variation of bearing is required to be very small
(Eg.: Precision measuring instrument, etc.)

2-2-5 Rotating Speed

The permissible speed for bearing varies depending on the types and sizes of bearings, and it depends also on the cage types and materials, bearing loads, and lubricating methods, etc.

The permissible speeds for KBC bearings in both cases of grease and oil lubrication are listed in the Dimension Table.

The permissible speed could be increased by improving the dimensional accuracy of bearing and its mating components enhancing the running accuracy of bearing, and adapting cooling lubrication and cages of special types and materials.

In general, thrust bearings have lower permissible speeds than radial bearings.

2-2-6 Misalignment of inner and outer rings

Inner and outer rings could become tilted due to various reasons, such as deflection of shaft caused by excessive load on long shaft or improper mounting procedures caused by fabrication defects in the mounted section.

Misalignment can also easily happen when independent housings, such as flanged or plummer block housings, are used.

The permissible misalignment for bearings varies

depending on their types and operating conditions. If the misalignment of inner and outer rings is large, the bearings with self-aligning capability, including self-aligning ball bearing, spherical roller bearing, or unit bearing, have to be used.

2-2-7 Noise and Torque

Both low noise level and torque are required for small electric equipments, office equipments, or home appliances. Deep groove ball bearings could be operated at a considerably low noise level, and they also produce low torque to make them quite suitable for above mentioned products. Various kinds of deep groove ball bearings of different noise levels are produced by KBC to meet different requirements for various usages.

2-2-8 Rigidity

When a load is applied to bearings, they deform elastically to certain degrees. If it deforms elastically very little, then its rigidity is said to be high, and if it deforms largely, then its rigidity is said to be low. If roller bearing is compared with ball bearing, then it is easy to guess that roller bearing has a higher rigidity, because its contact area between rolling elements and raceway is larger than ball bearing.

In many cases for angular contact ball bearings or tapered roller bearings, load is applied in advance to slightly deform them elastically, which, in return, increase their rigidity. This is called preload.

2-2-9 Mounting and Dismounting

Because all of cylindrical roller bearings, tapered roller bearings, and needle roller bearings are separable, it is easy to mount and dismount these bearings.

Also, the bearings with tapered bore can be easily mounted or dismounted by using adapter sleeve or withdrawal sleeve.

For the machines required to be assembled or disassembled frequently for periodic inspections or repairs, it is necessary for them to have the bearings that provide easy mounting and dismounting like the ones mentioned above.

2. Selection of Bearings

2-3 Bearing Arrangements

Rotating shaft needs to be supported by two or more bearings. At this time, following items have to be considered to determine the optimum bearing arrangements.

- Measures to be taken against elongation or contraction of shaft caused by temperature changes.
- Convenience and Easiness in mounting or dismounting the bearings.
- Rigidity of rotating components including bearings and preload method
- Misalignment of inner and outer rings caused by deflection of shaft or mismounting
- Appropriate distribution of axial and radial loads.

2-3-1 Locating Bearing and Floating Bearing

It is common to find the center of shaft not aligned properly with the center of housing, due to mismounting. Also the temperature elevation during the operation makes the shaft become longer. These changes in length are corrected by floating bearing.

Cylindrical roller bearings of N and NU types are the ideal floating bearings. These bearings are structured, so that the assembled components of roller and cage can move in axial direction on the lipless ring.

For deep groove ball bearings or spherical roller bearings, either inner or outer ring has to be loosely fitted for them to serve the same role as floating bearings. When it is applied with static load, either ring could be loosely fitted, but, in general, outer rings more than inner rings are chosen for loose fitting.

On the other hand, the locating bearings have to be carefully selected considering how big the axial load is, and how precisely the shaft has to be guided.

When the distance between bearings is too short, or the temperature changes in shaft is negligible enough not to cause any significant expansion of shaft, they can be used regardless of locating or floating sides. For example, there is a bearing arrangement which uses the combination of two angular contact ball bearings or tapered roller bearings that can receive axial load in one direction.















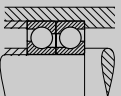

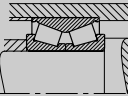
In this case, axial clearance after mounting can be adjusted by using the shim or the nuts.

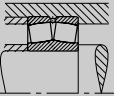
2-3-2 Examples of Bearing Arrangement

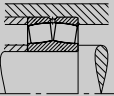
Examples of bearing arrangements considering preload, rigidity, shaft expansion and mismatching,

etc. are shown on the Table 2-3, 2-4, and 2-5 as follows.

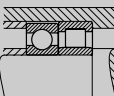
Table 2-3 Examples of locating / floating Bearing Arrangement

Bearing Arrangements Locating	Floating	Contents	Examples(Reference)
		<ul style="list-style-type: none"> - Most common arrangement - Not only radial load but also axial load to a certain degree could be applied. 	Small pumps Automobile transmission
		<ul style="list-style-type: none"> - High rotating speeds can be obtained, if the degree of mismatching is small and the deflection of the shaft is minimal. - Even if shaft is expanded and contracted repeatedly, it does not generate the abnormal axial load on the bearing. 	Medium sized electric motor Air blower
		<ul style="list-style-type: none"> - Most appropriate to be used when comparatively larger axial loads are applied in both direction - Double-row angular contact ball bearing could be used instead of combined angular contact ball bearing. 	Worm gear reducer
		<ul style="list-style-type: none"> - It is used when comparatively larger loads are applied. - Rigidity could be increased by the back-to-back arrangement of locating bearings with preload - It is necessary to reduce the mismatching by manufacturing both shaft and housing precisely. 	Main shaft of large lathe machine Table roller for steel mills
		<ul style="list-style-type: none"> - Radial load as well as an axial load to certain degree can be applied. - Both inner and outer rings could be tightly fitted. 	Calender roll for paper making machine Axle box for diesel train
		<ul style="list-style-type: none"> - It is commonly used when comparatively larger loads and impact loads are applied. - It is appropriate to use when mismatching or shaft deflection is expected. 	Axle box of overhead crane driving wheel Large size reducer
		<ul style="list-style-type: none"> - It is commonly used when comparatively larger loads and impact loads are applied, and also axial loads to a certain degree can be applied. - It is suitable when both inner and outer rings are tightly fitted. 	Traction motor for automotive vehicles
		<ul style="list-style-type: none"> - It is used when the shaft rotates at a high speed and when comparatively larger radial and axial loads are applied. - For deep-groove ball bearings, space between outer ring and housing should be provided to prevent radial load from being applied. 	Transmission for diesel train

2. Selection of Bearings

Table 2-4 Examples of Bearing Arrangements that do not distinguish locating or floating bearings



Bearing Arrangements	Contents	Examples(Reference)
	<ul style="list-style-type: none"> - Most common arrangement for small machines. - Preload could be applied by using the spring laterally to the side of outer ring of bearing. 	Small electric motor
	<ul style="list-style-type: none"> - Both radial and axial load can be applied, and it is suitable for high speeds. - It is suitable when rigidity of the shaft must be increased through preload - If a moment is applied, back-to-back arrangement is preferable than face-to-face arrangement. 	Main shaft of machine tools
	<ul style="list-style-type: none"> - It is commonly used when comparatively larger loads and impact loads are applied. - It is suitable when both inner and outer rings are tightly fitted. - Consideration has to be taken to prevent axial clearance from becoming too tight during operation. 	Final reduction gear for construction machine Sheave for mining machine
	<ul style="list-style-type: none"> - It is commonly used when comparatively larger loads and impact loads are applied. - When the distance between bearings is small, and when moment is applied, back-to-back arrangement is advantageous. On the other hand, when mismounting is considerably large enough, face-to-face arrangement is advantageous. - Face-to-face arrangement is easier when inner and outer rings are tightly fitted. - Care must be taken when applying the preload and when adjusting the clearance. 	Automobile wheels Worm gear reducer Pinion shaft
		

Table 2-5 Examples of Bearing Arrangements of vertical shaft

Bearing Arrangements	Contents	Examples(Reference)
	<ul style="list-style-type: none"> - Combined angular contact ball bearings are locating bearings, and cylindrical roller bearing is floating bearing. 	Small electric motor Small reducer
	<ul style="list-style-type: none"> - It is suitable when axial load is comparatively large. - The center of thrust spherical roller bearing needs to be aligned with that of spherical roller bearing. 	Central axle of crane

3. Rated Load and Bearing Life

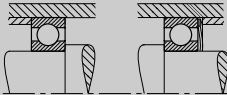
3. Rated Load and Bearing Life

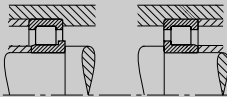
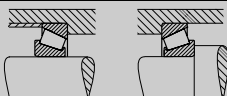
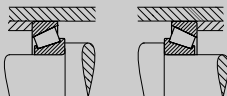
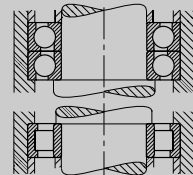
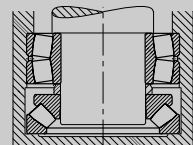
3-1 Bearing Life

Required properties for bearings are;

- Large load capacity and rigidity
- Small friction loss
- Smooth rotation, etc.

And, these properties should last for a specified period.

Even if bearings are used under the normal conditions, it is inevitable for flaking to happen to them after some period, due to deterioration of grease, repeatedly applied stress to raceway or rolling element, and/or general wear and tear, which in return increase the noise/vibration level and lower their accuracy.

Progress of flaking eventually ends the bearing's life. The life of bearing can be measured either by total number of rotations or by a life period, and depending on measuring criteria, they are called as noise life, tear life, grease life, or rolling fatigue life. However, the rolling fatigue life is most commonly used when mentioning the life of bearing, and a lot of times, it is just called as the bearing life.

Also, bearings could stick to the raceway after burning or become cracked or rusted, but these incidences are regarded as the failures, and should be distinguished from the expected life span of bearings.

3-2 Basic Rating Life and Dynamic Load Rating

Lives of bearings of a kind vary widely, even if they have been operating under the same condition, as shown in the Table 3-1 below. This is because the fatigue level for each bearing is different. Therefore, it is meaningless to choose the average life of bearings as the life of a certain bearing, so, the statistically-obtained rating lives are used instead.

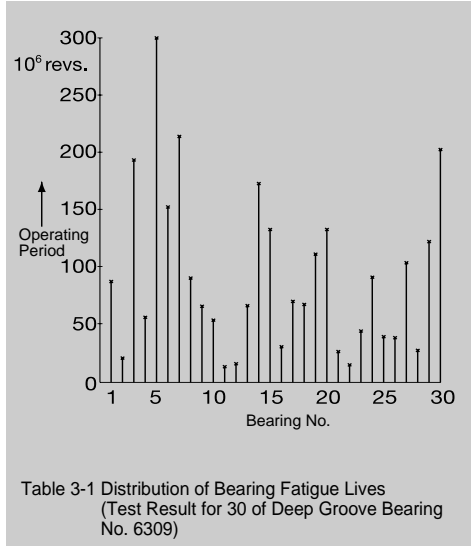

Basic rating life is the total number of rotations or total rotation time, that could be achieved by 90% of bearings of a kind, which have been rotated under the same condition.

Basic dynamic load rating, representing the bearing's dynamic load carrying capacity, is the load with constant direction and magnitude, which allows one million rotations of rated fatigue life when outer ring is fixed and inner ring is rotating. Radial bearing takes only the pure radial loads, and thrust bearing takes only the pure axial loads.

Basic rating lives of KBC bearings have been determined in accordance with ISO 281/1 and KS B 2019, and Cr of radial bearing and Ca of thrust bearing are shown in the dimension tables.

The correlations among bearing's basic rating life, basic dynamic load rating, and dynamic equivalent load are shown in the Equation 3-1. Also, when basic rating life is represented as a rotating period, their relations are shown in the Equation 3-2.

3. Rated Load and Bearing Life

$$L_{10} = L = \left(\frac{C}{P}\right)^p \dots\dots\dots \text{(Equation 3-1)}$$

$$L_{h10} = L_h = \frac{(C/P)^p}{60 \cdot n} = \frac{L_{10}}{60 \cdot n} \dots\dots\dots \text{(Equation 3-2)}$$

Whereas,

L_{10}, L : Basic rating life [10⁶ Rotations]

L_{h10}, L_h : Basic rating life [Time]

C : Basic dynamic load rating [N], {kgf}

P : Dynamic equivalent load [N], {kgf}
(Refer to Pg. 34)

p : Life exponent

Ball bearing $p=3$

Roller bearing $p=10/3$

n : Rotating speed [rpm]

Here the speed is 33^{1/3} min⁻¹ when 1 is for ball bearings the values of L_h and f_L rotational speed n and f_n are shown in tables 3-1 and 3-2 where as for roller bearings the values are shown table 3-3 and 3-4.

Bearing life equation can be simplified as below using dynamic load factor and speed factor.

$$f_L = \frac{C}{P} \cdot f_n \dots\dots\dots \text{(Equation 3-5)}$$

Above equation can be changed to;

$$L_h = \frac{L \cdot 500 \cdot 33^{1/3} \cdot 60}{n \cdot 60}$$

$$\frac{L_h}{500} = \left(\frac{C}{P}\right)^p \cdot \left(\frac{33^{1/3}}{n}\right)$$

$$\text{or, } \sqrt[p]{\frac{L_h}{500}} = \sqrt[p]{\frac{33^{1/3}}{n}} \cdot \frac{C}{P}$$

From above equation, both dynamic load factor and speed factor can be calculated.

Dynamic load factor f_L is defined as follows.

$$f_L = \sqrt[p]{\frac{L_h}{500}} \dots\dots\dots \text{(Equation 3-3)}$$

Here, when $f_L=1$, the life can be calculated to be 500 hours.

Speed factor f_n is obtained as follows.

$$f_n = \sqrt[p]{\frac{33^{1/3}}{n}} \dots\dots\dots \text{(Equation 3-4)}$$

Table 3-1 Basic Rating Life and Dynamic Load Factor f_L (for Ball Bearings)

$$f_L = \sqrt[3]{\frac{L_h}{500}}$$

L_h h	f_L	L_h h	f_L	L_h h	f_L	L_h h	f_L	L_h h	f_L
100	0.585	420	0.944	1700	1.5	6500	2.35	28000	3.83
110	0.604	440	0.958	1800	1.53	7000	2.41	30000	3.91
120	0.621	460	0.973	1900	1.56	7500	2.47	32000	4
130	0.638	480	0.986	2000	1.59	8000	2.52	34000	4.08
140	0.654	500	1	2200	1.64	8500	2.57	36000	4.16
150	0.669	550	1.03	2400	1.69	9000	2.62	38000	4.24
160	0.684	600	1.06	2600	1.73	9500	2.67	40000	4.31
170	0.698	650	1.09	2800	1.78	10000	2.71	42000	4.38
180	0.711	700	1.12	3000	1.82	11000	2.8	44000	4.45
190	0.724	750	1.14	3200	1.86	12000	2.88	46000	4.51
200	0.737	800	1.17	3400	1.89	13000	2.96	48000	4.58
220	0.761	850	1.19	3600	1.93	14000	3.04	50000	4.64
240	0.783	900	1.22	3800	1.97	15000	3.11	55000	4.79
260	0.804	950	1.24	4000	2	16000	3.17	60000	4.93
280	0.824	1000	1.26	4200	2.03	17000	3.24	65000	5.07
300	0.843	1100	1.3	4400	2.06	18000	3.3	70000	5.19
320	0.862	1200	1.34	4600	2.1	19000	3.36	75000	5.31
340	0.879	1300	1.38	4800	2.13	20000	3.42	80000	5.43
360	0.896	1400	1.41	5000	2.15	22000	3.53	85000	5.54
380	0.913	1500	1.44	5500	2.22	24000	3.63	90000	5.65
400	0.928	1600	1.47	6000	2.29	26000	3.73	100000	5.85

Table 3-2 Rotating Speed and Speed Factor f_n (for Ball Bearings)

$$f_n = \sqrt[3]{\frac{33\frac{1}{2}}{n}}$$

n min ⁻¹	f_n	n min ⁻¹	f_n	n min ⁻¹	f_n	n min ⁻¹	f_n	n min ⁻¹	f_n
10	1.49	55	0.846	340	0.461	1800	0.265	9500	0.152
11	1.45	60	0.822	360	0.452	1900	0.26	10000	0.149
12	1.41	65	0.8	380	0.444	2000	0.255	11000	0.145
13	1.37	70	0.781	400	0.437	2200	0.247	12000	0.141
14	1.34	75	0.763	420	0.43	2400	0.24	13000	0.137
15	1.3	80	0.747	440	0.423	2600	0.234	14000	0.134
16	1.28	85	0.732	460	0.417	2800	0.228	15000	0.131
17	1.25	90	0.718	480	0.411	3000	0.223	16000	0.128
18	1.23	95	0.705	500	0.405	3200	0.218	17000	0.125
19	1.21	100	0.693	550	0.393	3400	0.214	18000	0.123
20	1.19	110	0.672	600	0.382	3600	0.21	19000	0.121
22	1.15	120	0.652	650	0.372	3800	0.206	20000	0.119
24	1.12	130	0.635	700	0.362	4000	0.203	22000	0.115
26	1.09	140	0.62	750	0.354	4200	0.199	24000	0.112
28	1.06	150	0.606	800	0.347	4400	0.196	26000	0.109
30	1.04	160	0.593	850	0.34	4600	0.194	28000	0.106
32	1.01	170	0.581	900	0.333	4800	0.191	30000	0.104
34	0.993	180	0.57	950	0.327	5000	0.188	32000	0.101
36	0.975	190	0.56	1000	0.322	5500	0.182	34000	0.0993
38	0.957	200	0.55	1100	0.312	6000	0.177	36000	0.0975
40	0.941	220	0.533	1200	0.303	6500	0.172	38000	0.0957
42	0.926	240	0.518	1300	0.295	7000	0.168	40000	0.0941
44	0.912	260	0.504	1400	0.288	7500	0.164	42000	0.0926
46	0.898	280	0.492	1500	0.281	8000	0.161	44000	0.0912
48	0.886	300	0.481	1600	0.275	8500	0.158	46000	0.0898
50	0.874	320	0.471	1700	0.27	9000	0.155	50000	0.0874

3. Rated Load and Bearing Life

Table 3-3 Basic Rating Life and Dynamic Load Factor f_L (for Roller Bearings)

$$f_L = \sqrt[10]{\frac{L_h}{500}}$$

L_h h	f_L	L_h h	f_L	L_h h	f_L	L_h h	f_L	L_h h	f_L
100	0.617	420	0.949	1700	1.44	6500	2.16	28000	3.35
110	0.635	440	0.962	1800	1.47	7000	2.21	30000	3.42
120	0.652	460	0.975	1900	1.49	7500	2.25	32000	3.48
130	0.668	480	0.988	2000	1.52	8000	2.3	34000	3.55
140	0.683	500	1	2200	1.56	8500	2.34	36000	3.61
150	0.697	550	1.03	2400	1.6	9000	2.38	38000	3.67
160	0.71	600	1.06	2600	1.64	9500	2.42	40000	3.72
170	0.724	650	1.08	2800	1.68	10000	2.46	42000	3.78
180	0.736	700	1.11	3000	1.71	11000	2.53	44000	3.83
190	0.748	750	1.13	3200	1.75	12000	2.59	46000	3.88
200	0.76	800	1.15	3400	1.78	13000	2.66	48000	3.93
220	0.782	850	1.17	3600	1.81	14000	2.72	50000	3.98
240	0.802	900	1.19	3800	1.84	15000	2.77	55000	4.1
260	0.822	950	1.21	4000	1.87	16000	2.83	60000	4.2
280	0.84	1000	1.23	4200	1.89	17000	2.88	65000	4.31
300	0.858	1100	1.27	4400	1.92	18000	2.93	70000	4.4
320	0.875	1200	1.3	4600	1.95	19000	2.98	80000	4.58
340	0.891	1300	1.33	4800	1.97	20000	3.02	90000	4.75
360	0.906	1400	1.36	5000	2	22000	3.11	100000	4.9
380	0.921	1500	1.39	5500	2.05	24000	3.19	150000	5.54
400	0.935	1600	1.42	6000	2.11	26000	3.27	200000	6.03

Table 3-4 Rotating Speed and Speed Factor f_n (for Roller Bearings)

$$f_n = \sqrt[10]{\frac{33 \frac{1}{2}}{n}}$$

n min ⁻¹	f_n	n min ⁻¹	f_n	n min ⁻¹	f_n	n min ⁻¹	f_n	n min ⁻¹	f_n
10	1.44	55	0.861	340	0.498	1800	0.302	9500	0.183
11	1.39	60	0.838	360	0.49	1900	0.297	10000	0.181
12	1.36	65	0.818	380	0.482	2000	0.293	11000	0.176
13	1.33	70	0.8	400	0.475	2200	0.285	12000	0.171
14	1.3	75	0.784	420	0.468	2400	0.277	13000	0.167
15	1.27	80	0.769	440	0.461	2600	0.270	14000	0.163
16	1.25	85	0.755	460	0.455	2800	0.265	15000	0.16
17	1.22	90	0.742	480	0.449	3000	0.259	16000	0.157
18	1.2	95	0.73	500	0.444	3200	0.254	17000	0.154
19	1.18	100	0.719	550	0.431	3400	0.25	18000	0.151
20	1.17	110	0.699	600	0.42	3600	0.245	19000	0.149
22	1.13	120	0.681	650	0.41	3800	0.242	20000	0.147
24	1.1	130	0.665	700	0.401	4000	0.238	22000	0.143
26	1.08	140	0.65	750	0.393	4200	0.234	24000	0.139
28	1.05	150	0.637	800	0.385	4400	0.231	26000	0.136
30	1.03	160	0.625	850	0.378	4600	0.228	28000	0.133
32	1.01	170	0.613	900	0.372	4800	0.225	30000	0.13
34	0.994	180	0.603	950	0.366	5000	0.222	32000	0.127
36	0.977	190	0.593	1000	0.36	5500	0.216	34000	0.125
38	0.961	200	0.584	1100	0.35	6000	0.211	36000	0.123
40	0.947	220	0.568	1200	0.341	6500	0.206	38000	0.121
42	0.933	240	0.553	1300	0.333	7000	0.201	40000	0.119
44	0.92	260	0.54	1400	0.326	7500	0.197	42000	0.117
46	0.908	280	0.528	1500	0.319	8000	0.193	44000	0.116
48	0.896	300	0.517	1600	0.313	8500	0.19	46000	0.114
50	0.885	320	0.507	1700	0.307	9000	0.186	50000	0.111

3-3 Adjusted Rating Life

The basic rating life of a bearing, the generally chosen method of stating a bearing life, can be obtained by using the Equations 3-1 and 3-2, but when the reliability of other than 90%(100-n%)(Where, n is the failure percentage) of bearing of a kind is required, they can be calculated by using the reliability factor a_1 from the following equation.

$$L_n = a_1 \cdot L_{10} \text{(Equation 3-6)}$$

Also, basic rating life is calculated, assuming that usual bearing materials are used, and that normal conditions(good mounting, lubrication, and vibration without extreme load or operating temperature) are provided, but, if an adjusting rating life, L_{10a} for the bearing made of special material or under special conditions, is needed, following equation using the life adjustment factors of both material factor, a_2 and operating condition factor a_3 can be applied.

$$L_{10a} = a_2 \cdot a_3 \cdot L_{10} \text{ (Equation 3-7)}$$

The adjusted rating life, L_{na} for the bearing requiring all the adjustments mentioned above, can be obtained using the following equation.

$$L_{na} = a_1 \cdot a_2 \cdot a_3 \cdot L_{10} \text{ (Equation 3-8)}$$

However, if bearing dimensions are selected by using the adjusted rating lives, or L_{na} larger than L_{10} , the variables other than life, such as permissible deformation and hardness of shaft or housing, etc., have to be taken into consideration.

Table 3-5 Reliability Factor

Reliability(%)	L_n	a_1
90	L_{10}	1
95	L_5	0.62
96	L_4	0.53
97	L_3	0.44
98	L_2	0.33
99	L_1	0.21

3-3-1 Reliability Factor a_1

When an adjusted rating life of reliability of 100-n% needs to be obtained, the values of reliability factor, a_1 shown in the following Table 3-5, have to be used.

3-3-2 Material Factor a_2

Reliability factor, a_2 , is used to adjust the bearing life, which lengthens due to better bearing materials, and for usual KBC bearings of standard materials and production, a_2 is 1.

For the bearings of special materials and production, a_2 is larger than 1, but, for the bearings treated for better stability of dimensions, a_2 can be smaller than 1, because their hardness could have been lowered. For detailed informations, please contact us.

3-3-3 Operating Condition Factor a_3

The operating condition factor, a_3 is used to adjust the bearing life influenced by operating conditions of bearings, specially, fatigue life by lubricating condition.

Where there is no inclining of inner and outer ring, and where rolling element is sufficiently separated from raceway by lubricant, a_3 is generally regarded to be 1.

However, a_3 is smaller than 1 in following cases.

- When kinetic viscosity is too low.

For ball bearings, below $13\text{mm}^2/\text{s}(1\text{mm}^2/\text{s}=1\text{cSt})$

For roller bearings, below $20\text{mm}^2/\text{s}$

- When rotating speed is too slow.

When rotating speed(rpm) times pitch circle diameter(mm) of rolling element is smaller than 10,000.

- When operating temperature of bearing is too high. (Refer to Table 3-6)

- When any foreign material or moisture is mixed with lubricant.

- When load distribution inside the bearing is abnormal.

However, for the bearing of specially improved material or production with $a_2 > 1$, $a_2 \cdot a_3 < 1$ if lubricating condition is poor.

3. Rated Load and Bearing Life

Table 3-6 Operating Condition Factor Based on Operating Temperatures

Operating Temperature	a_3
150°C	1
200°C	0.73
250°C	0.42
300°C	0.22

3-4 Operating Machine and Required Life

When selecting a bearing, it is not economical to choose a bearing of fatigue life unnecessarily longer than required, because it usually means a bigger bearing. In other words, a bearing life should not be a sole factor in selecting a bearing, but all of strength, rigidity, and dimension of shaft to which bearing is to be mounted have also to be considered.

Table 3-7 shows the dynamic load factors f_L and typical machines of application for each of various application methods, safety factors, operating intervals and cycles.

Table 3-7 Dynamic Load Factor f_L and Typical Machines of Application

Operating Condition	Values of f_L and Typical Applications				
	Below 2	2...3	3...4	4...6	6
Occasional short operation	Vacuum Washer Motored Tools	Farming machines Office machines			
Occasional short operation but requires high reliability	Medical instrument	Construction equipment Air-conditioner for homes Hot-water circulation pump	Elevator Crane		
Fairly long operation although not continuously	Small motor Passenger cars Bus Truck	Machine tools Crusher Vibration screen	Rotary press Compressor		
More than 8 hours of continuous operation per day		Escalator	Axle box for passenger coaches Air conditioner Large motor Knitting machine	Axle box for locomotive cars Traction motor Press machine	Paper making machine
Continuous operation requiring high reliability				Spinning machine	Power generating equipment Pumping equipment Mine draining equipment

3-5 Basic Static Load Rating

When an excessive load or sudden impact load is applied to a bearing, permanent plastic deformation, namely indentation, to the contact area between raceway and rolling element might occur. The larger the applied load is, the bigger the indentation, and the greater it hinders with smooth rotation of bearing.

Basic static load rating, C_0 , is the load that theoretically generates the contact stress as follows on the center of contact area between rolling element and raceway, where the most load is applied.

- Self-aligning ball bearing 4600 N/mm²
- All ball bearings 4200 N/mm²
(Except self-aligning ball bearings)
- All roller bearings 4000 N/mm²

When this basic static load rating, C_0 , is applied to a bearing, the sum of permanent plastic deformation of rolling element and raceway at the contact point, where the most load is applied, gets to be approximately 1/10,000 of diameter of rolling element.

The values of basic static load rating, C_0 , are represented as C_{0r} for radial bearings, and C_{0a} for thrust bearings, but in the dimension tables, they are simply shown as C_0

3-6 Permissible Static Equivalent Load

A static load factor, f_s , is calculated to check whether a bearing with appropriate load rating has been selected.

$$f_s = \frac{C_0}{P_0} \dots\dots\dots \text{(Equation 3-9)}$$

Whereas,

- f_s : Static load factor
 - C_0 : Static load rating [N], {kgf}
 - P_0 : Static equivalent load [N], {kgf}
- (Refer to Page 34.)

Static load factor, f_s , is the safety factor against the permanent plastic deformation of contact area of rolling element. The value of f_s has to be large enough to insure the smooth and especially quiet operation, however, if it is not required to be too quiet, then small value of f_s should be sufficient. Generally, the values shown in the following Table 3-8 are recommended.

Table 3-8 Static Load Factor f_s

Operating Conditions of Bearings	Lower Limit of f_s Ball Bearing	Roller Bearing
Specially quiet operation	2	3
Existence of vibration/impact	1.5	2
Normal operation	1	1.5
Not too quiet operation	0.5	1

4. Calculation of Bearing Load

4. Calculation of Bearing Load

In order to obtain the values of loads applied to a bearing, all of weight of rotating element, transmitting force by gear or belt, and load generated by the machine have to be calculated first. Some of these loads are theoretically calculable, but the others are difficult to obtain. So, various empirically obtained coefficients have to be utilized.

4-1 Load Applied to Shaft

4-1-1 Load Factor

The actual load applied to the bearing mounted on the shaft could be bigger than theoretically calculated value. In this case, following equation is used to calculate the load applied to the shaft.

$$F = f_w \cdot F_c \text{ (Equation 4-1)}$$

Where,

- F : Actual load applied to the shaft
- f_w : Load factor(Refer to Table 4-1)
- F_c : Theoretically calculated load

Table 4-1 Load Factor f_w		
Operating Conditions	Typical Applications	f_w
Smooth Operation without Sudden Impact	Motor, machine tools, air-conditioner	1.....1.2
Normal Operation	automotive vehicle, paper-making machine, elevator, crane	1.2.....1.5
Operation with vibration and sudden impact	Crusher, construction equipment, farming equipment	1.5.....3

4-1-2 Load Applied to Spur Gear

Calculation methods for loads applied to gears vary depending on gear types of different rolling methods, but for the simplest spur gear, it is done as follows.

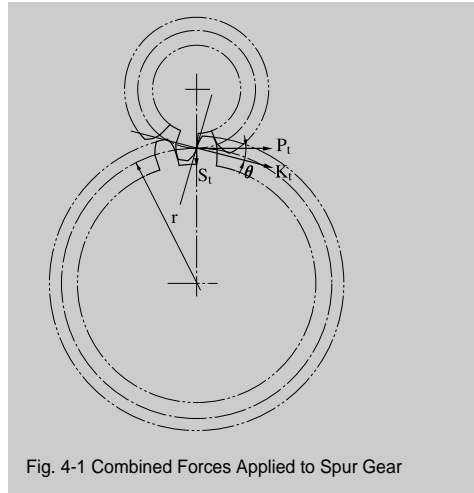

Fig. 4-1 Combined Forces Applied to Spur Gear

$$M = 9,550,000 \cdot H / n \text{ (Equation 4-2)}$$

$$P_t = M / r \text{ (Equation 4-3)}$$

$$S_t = P_t \cdot \tan\theta \text{ (Equation 4-4)}$$

$$K_t = \sqrt{P_t^2 + S_t^2} = P_t \cdot \sec\theta \text{ (Equation 4-5)}$$

Where,

- M : Torque applied to gear [N·mm]
- P_t : Tangential force of gear [N]
- S_t : Radial force of gear [N]
- K_t : Combined force applied to gear [N]
- H : Rolling force [kW]
- n : Rotating speed [rpm]
- r : Pitch circle diameter of driven gear [mm]
- θ : Pressure angle

Other than the theoretical loads obtained above, vibration and/or impact are also applied to the gear depending on its tolerances. Therefore, the actually applied loads are obtained by multiplying theoretical loads by gear factor, f_g (Refer to the

Table 4-2).

Here, when accompanied by vibration, following equation can be used to obtain the load by multiplying gear factor, f_g , by load factor, f_w .

$$F = f_g \cdot f_w \cdot K_t \dots\dots\dots \text{(Equation 4-6)}$$

Table 4-2 Gear Factor f_g

Gear Types	f_g
Precision Ground Gear (Below 0.02mm of pitch error and form error)	1..... 1.1
Normal Cutting Gear (Below 0.01mm of pitch error and form error)	1.1.....1.3

The actually applied loads are obtained, as shown in the following equation, by multiplying factor, f_b , (For chain transmission, vibration/impact loads have to be considered, and for belt transmission, initial tension.) by effective transmitting force.

$$F = f_b \cdot K_t \dots\dots\dots \text{(Equation 4-9)}$$

Table 4-3 Chain/Belt Factor, f_b

Chain/Belt Types	f_b
Chain	1.5
V Belt	2.....2.5
Fabric Belt	2.....3
Leather Belt	2.5.....3.5
Steel Belt	3.....4
Timing Belt	1.5.....2

4-1-3 Loads Applied to Chain and Belt

Loads applied to sprocket or pulley, when power is transmitted through chain or belt, are as follows.

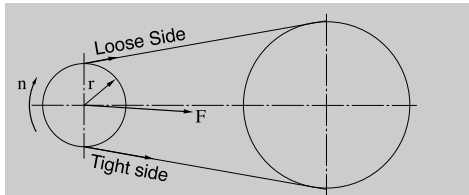

Fig. 4-2 Loads Applied to Chain and Belt

$$M = 9,550,000 \cdot H / n \dots\dots\dots \text{(Equation 4-7)}$$

$$K_t = M / r \dots\dots\dots \text{(Equation 4-8)}$$

Where,

- M : Torque applied to sprocket or pulley [N·mm]
- K_t : Effective transmitting force of chain or belt [N]
- H : Transmitting power [kW]
- n : Rotating speed [rpm]
- r : Effective radius of sprocket or pulley [mm]

4. Calculation of Bearing Load

4-2 Average Load

Loads applied to a bearing usually fluctuate in various ways. At this time, loads applied to the bearing are transformed to mean load, which yields same life, to calculate the fatigue life.

4-2-1 Fluctuation by Stages

When fluctuating by stages like in the Fig. 4-3, the below equation is used to get the mean load, P_m .

$$P_m = \sqrt[p]{\frac{t_1 n_1 P_1^p + t_2 n_2 P_2^p + \dots + t_n n_n P_n^p}{t_1 n_1 + t_2 n_2 + \dots + t_n n_n}} \quad \text{(Equation 4-10)}$$

Where,

- $p : 3$ for ball bearing
- $10/3$ for roller bearing

Average speed, n_m , can be obtained from the Equation 4-11.

$$n_m = \frac{t_1 n_1 + t_2 n_2 + \dots + t_n n_n}{t_1 + t_2 + \dots + t_n} \quad \text{(Equation 4-11)}$$

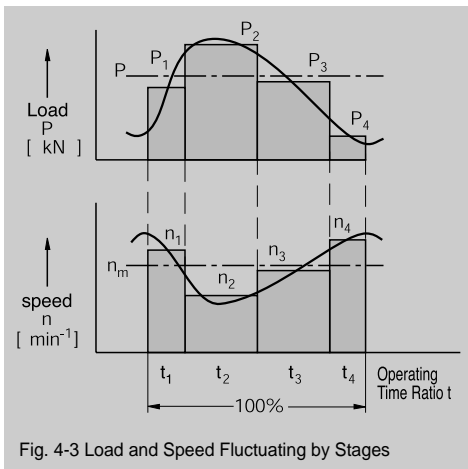
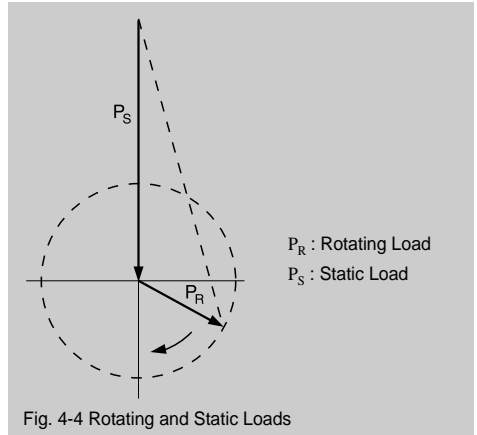

Fig. 4-3 Load and Speed Fluctuating by Stages

4-2-2 Rotating and Static Loads

When both rotating and static loads are applied at the same time, the mean load, P_m , can be obtained by using both Equation 4-12 and 4-13.



- When $P_R \geq P_S$

$$P_m = P_R + 0.3 \cdot P_S + 0.2 \frac{P_S^2}{P_R} \quad \text{(Equation 4-12)}$$

- When $P_R < P_S$

$$P_m = P_S + 0.3 \cdot P_R + 0.2 \frac{P_R^2}{P_S} \quad \text{(Equation 4-13)}$$

4-2-3 Continuous Fluctuation

When load is fluctuating continuously like in the Fig. 4-5, the below equations are used to get the mean loads.

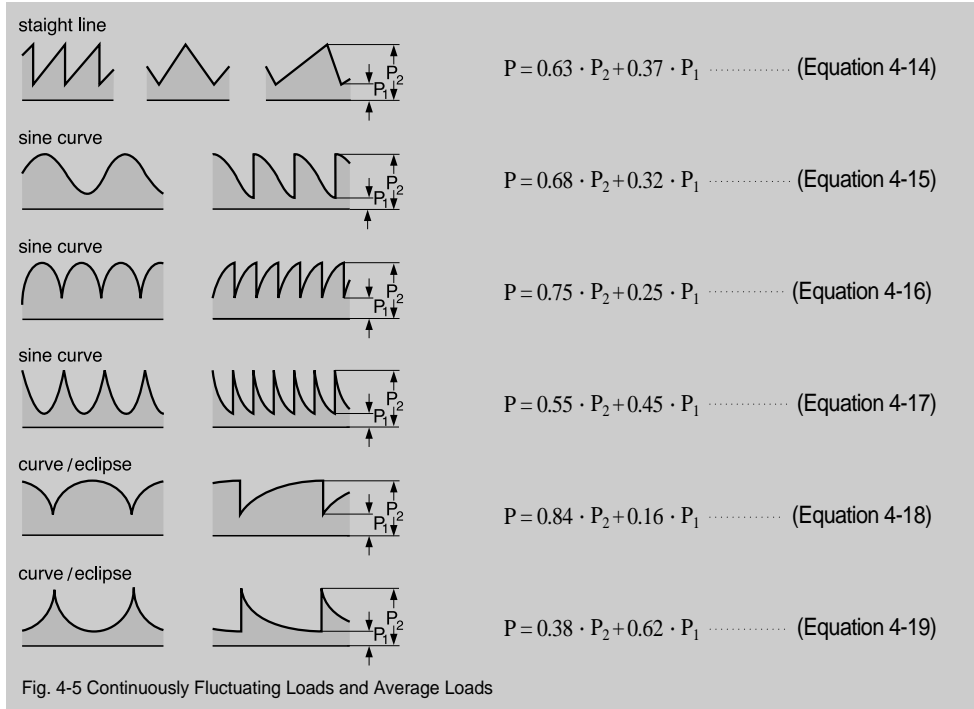

Fig. 4-5 Continuously Fluctuating Loads and Average Loads

4-3 Equivalent Load

4-3 Equivalent Load

4-3-1 Dynamic Equivalent Load

A load applied to a bearing usually is a combined load of radial and axial loads.

If this is the case, then the load applied to a bearing itself can not be directly applied to the life calculating equation.

Therefore, a virtual load, obtained assuming that it has same life as when the combined load actually applies, applied to the center of bearing has to be obtained first to calculate the bearing life. This kind of load is called as the dynamic equivalent load.

The Equation to obtain the dynamic equivalent load of radial bearing is shown below.

$$P = X \cdot F_r + Y \cdot F_a \quad \text{..... (Equation 4-20)}$$

Where,

- P : Dynamic equivalent load [N], {kgf}
- F_r : Radial load [N], {kgf}
- F_a : Axial load [N], {kgf}
- X : Radial load factor
- Y : Axial load factor

The values of X and Y are listed in the dimension tables.

For thrust spherical roller bearings, dynamic equivalent load can be obtained using following Equation.

$$P = F_a + 1.2 \cdot F_r \quad \text{..... (Equation 4-21)}$$

Provided, $F_r \leq 0.55 \cdot F_a$

4-3-2 Static Equivalent Load

Static equivalent load is a virtual load that generates the same magnitude of deformation as the permanent plastic deformation occurred at the center of contact area between rolling element and raceway, to which the maximum load is applied.

For the static equivalent load of radial bearing,

the bigger value between the ones obtained by using both Equation 4-22 and 4-23, needs to be chosen.

$$P_0 = X_0 \cdot F_r + Y_0 \cdot F_a \quad \text{..... (Equation 4-22)}$$

$$P_0 = F_r \quad \text{..... (Equation 4-23)}$$

Where,

- P₀ : Static equivalent load [N], {kgf}
- F_r : Radial load [N], {kgf}
- F_a : Axial load [N], {kgf}
- X₀ : Static radial load factor
- Y₀ : Static axial load factor

For thrust spherical roller bearings, the static equivalent load is obtained by using following Equation.

$$P_0 = F_a + 2.7 \cdot F_r \quad \text{..... (Equation 4-24)}$$

Provided, $F_r \leq 0.55 \cdot F_r$

4-3-3 Load Calculation for Angular Contact Ball Bearing and Tapered Roller Bearing

The load-applied point for angular contact ball bearings and tapered roller bearings lies at a crossing point between extended contact line and center shaft line, as shown in Fig. 4-6, and the locations of load-applied points are listed in each of bearing dimension tables.

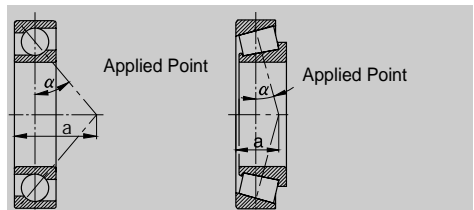

Fig. 4-6 Load Applied Point

Because the rolling areas of both angular contact ball bearings and tapered roller bearings are inclined, its radial load generates axial repulsive

force, and this repulsing force has to be taken into consideration when calculating the equivalent loads.

This axial component force can be obtained by using the following Equation 4-25.

$$F_a = 0.5 \frac{F_r}{Y} \dots \dots \dots \text{(Equation 4-25)}$$

Where,

F_a : Axial component force [N], {kgf}

F_r : Radial force [N], {kgf}

Y : Axial load factor

Axial loads are calculated by using the formula in the Table 4-4.

A bearing that receives the outside axial load K_a (No relation to axial reaction force) is marked as 'A', and the opposite bearing as 'B'.

Value Y can be calculated by using the dynamic equivalent load equation and table dimensions Y is a given constant of axial load F_a

Table 4-4 Axial Loads of Angular Contact Ball Bearings and Tapered Roller Bearings

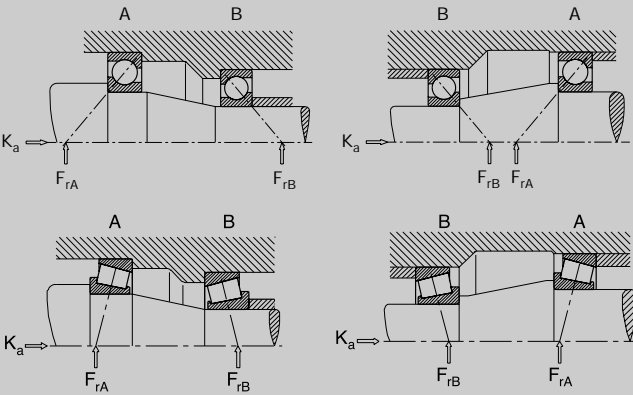

Load Conditions

Axial load F_a to be considered when calculating a dynamic equivalent load.

	Bearing A	Bearing B
$\frac{F_{rA}}{Y_A} \leq \frac{F_{rB}}{Y_B}$	$F_a = K_a + 0.5 \cdot \frac{F_{rB}}{Y_B}$	-
$\frac{F_{rA}}{Y_A} > \frac{F_{rB}}{Y_B}$	$F_a = K_a + 0.5 \cdot \frac{F_{rB}}{Y_B}$	-
$K_a > 0.5 \cdot \left(\frac{F_{rA}}{Y_A} - \frac{F_{rB}}{Y_B} \right)$		
$\frac{F_{rA}}{Y_A} > \frac{F_{rB}}{Y_B}$	-	$F_a = 0.5 \cdot \frac{F_{rA}}{Y_A} - K_a$
$K_a \leq 0.5 \cdot \left(\frac{F_{rA}}{Y_A} - \frac{F_{rB}}{Y_B} \right)$		

5. Permissible Bearing Speed

5. Permissible Bearing Speed

If a bearing rotates at a very high speed, then it heats up, and the deterioration of lubricant accelerates, and eventually, they are burnt to stick to the raceway.

The permissible bearing speed is the maximum speed that allows the bearing to operate for a long time without causing any of above mentioned problems.

Permissible bearing speed (rpm) varies depending on various factors, such as its type and size, cage type, material, lubrication method, and the heat expansion method dictated by the design of surrounding structure, etc. So the empirical value of $d_m \cdot n$ (d_m is the mean value in mm of bearing's inner and outer diameters, and n is the number of rotations rpm) is used.

Permissible speeds for the bearings lubricated with grease or oil are shown in the dimension tables. The values of permissible speed shown in the dimension tables are determined on the condition that standard design bearings are operated under the normal loads ($C/P \geq 12$, $F_d/F_r \leq 0.2$). For the permissible speed in terms of oil lubrication listed in the bearing dimension tables, the general oil sump lubrication is used as a standard.

For some types of bearings, even if they perform well in most other areas, they might not be suitable for high speed rotation. Therefore, when the operating speed of a bearing reaches above the 70% of listed permissible speed, the good-quality grease or oil suitable for high speed operation should be used (Refer to Table 12-2, 12-4, and 12-6)

5-1 Correction of Permissible Speed

When a bearing is not under normal load condition, the permissible bearing speed can be calculated by using below Equations.

For radial bearings,

$$n = f_s \cdot f_l \cdot f_d \cdot A / d_m \dots\dots\dots \text{(Equation 5-1)}$$

For thrust bearings,

$$n = f_s' \cdot f_l \cdot f_d \cdot A \cdot \sqrt{D \cdot H} \dots\dots\dots \text{(Equation 5-2)}$$

- n : Permissible speed [rpm]
- d_m : Average of bearing's inner and outer diameters [mm]
- D : Bearing's outer diameter [mm]
- H : Mounted height of thrust bearing [mm]
- f_s : Dimension factor of radial bearing (Refer to Fig5-1)
- f_s' : Dimension factor of thrust bearing (Refer to Fig5-1)
- f_l : Load magnitude factor (Refer to Fig. 5-2)
- f_d : Load magnitude factor (Refer to Fig. 5-3)
- A : Constant determined by bearing type and lubrication method (Refer to Table 5-1)

The permissible speeds of radial and thrust bearings listed in the dimension tables are the speeds that dimension factor, f_s or f_s' , has been taken into consideration, so above equations can be simply stated as follows.

$$n = f_l \cdot f_d \cdot n_{\max} \dots\dots\dots \text{(Equation 5-3)}$$

Where, n_{\max} is a permissible speed listed in the dimension tables.

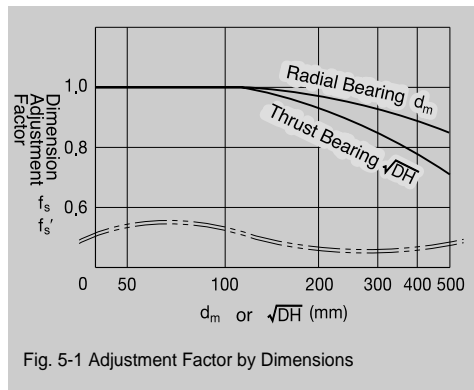

Fig. 5-1 Adjustment Factor by Dimensions

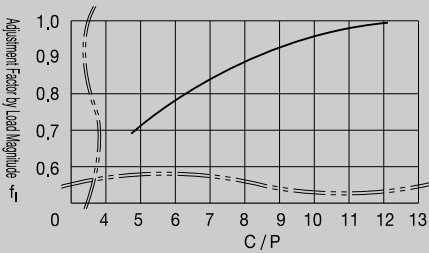

Fig. 5-2 Adjustment Factor by Load Magnitude

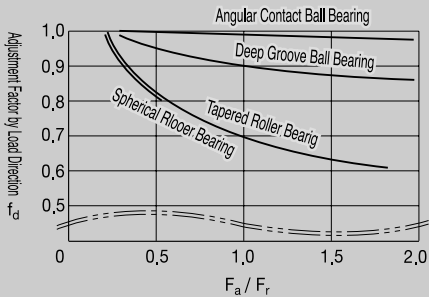

Fig. 5-3 Adjustment Factor by Load Direction

Table 5-2 Permissible speed adjustment factor for higher speed

Bearing Type	Adjustment Factor
Deep Groove Ball Bearing	3
Single Row Angular Contact Ball Bearing	
Contact Angle 15°	1.5
Contact Angle 25°, 30°	2
Single Row Cylindrical Roller Bearing	2.5
Tapered Roller Bearing	2
Spherical Roller Bearing	1.5
Needle Roller Bearing(Except broad width)	2

Also, when the measures on bearing's tolerances, clearance, cage type, material, and/or lubricating methods, are taken to allow high speeds, bearings can be operated in a higher speed than the permissible speed. When all these conditions have been sufficiently examined, the maximum permissible speed could be increased to the speed obtained by multiplying the permissible speed listed in the dimension tables by adjustment factor in the Table 5-2.

Table 5-1 Value A that Determines the Permissible Speed

Kinds		Grease Lubrication	Oil Sump Lubrication
Radial Bearing	Deep Groove Ball Bearing	500,000	600,000
	Single Row Angular Contact Ball Bearing		
	Contact Angle 15°	700,000	1,000,000
	Contact Angle 30°	450,000	600,000
	Contact Angle 40°	400,000	500,000
	Double Row Angular Contact Ball Bearing	350,000	400,000
	Self-Aligning Ball Bearing	400,000	500,000
	Cylindrical Roller Bearing	500,000	600,000
Thrust Bearing	Tapered Roller Bearing	250,000	350,000
	Spherical Roller Bearing	250,000	350,000
	Thrust Ball Bearing	100,000	150,000
	Thrust Self-Aligning Ball Bearing	-	200,000

5. Permissible Bearing Speed

5-2 Permissible Speed for Bearings with Rubber Contact Seal

The maximum permissible speed for bearings with rubber contact seal(DD Class and others) is determined depending on the surface sliding speed of seal lip and bearing inner ring.

The values of permissible speeds are listed in the dimension tables.

6. Boundary Dimensions and Designated Numbering System

6. Boundary Dimensions and Designated Numbering System

6-1 Selection of Dimensions

Once the fatigue life, L_r , required for the machine is determined, the basic dynamic load rating, C , required for the bearing at the dynamic equivalent load, P , can be obtained by applying the rating life equation. Using this dynamic load rating, an appropriate bearing can be selected from the dimension tables in this Catalogue.

If the inner/outer diameters and width are within the limits of the permissible space of the machine, then the selected bearing can be applied as is. However, if they are found to be outside these limits, then the changes in bearing type or bearing life cycle should be considered.

6-2 Boundary Dimensions

Boundary dimensions of bearings as shown in picture 6.1~ 6.3 are inner/outer diameters, width, assembled width(Tapered roller bearings), height(Thrust bearings), and chamfer dimensions, etc. Boundary dimensions of bearings are standardized in accordance with ISO standards for international interchangeability and economical production, The Korean Industrial Standards(KS), have been established based on the ISO standards.

Boundary dimensions for radial bearings(Except tapered roller bearings) comply with ISO 15 and KS B 2013, and the dimension classifications by contact angles of tapered roller bearings of metric series comply with those of ISO 355 and KS B 2013, where as main dimensions that are in accordance with dimension series(Refer to 6-3 Designation Systems) comply with KS B 2027.

Dimensions of thrust bearings comply with ISO 104 and KS B 2022.

Boundary dimensions by dimension series are shown in Table 6-1 and 6-2 for radial bearings,

Table 6-3 for tapered roller bearings of metric series, and Table 6-4 for thrust bearings.

Also, dimensions for snapping groove and snapping ring, and boundary dimensions of housing seating are shown in Table 6-5 and 6-6, respectively.

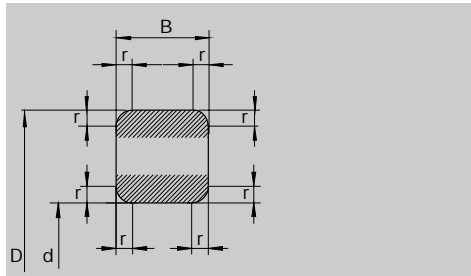

Fig. 6-1 Radial Bearings(Except tapered roller bearings)

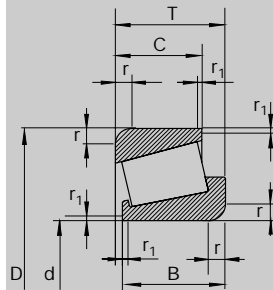

Fig. 6-2 Tapered Roller Bearings

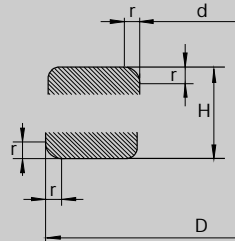

Fig. 6-3 One-Way Thrust Ball Bearings

6. Boundary Dimensions and Designated Numbering System

Table 6-1 Boundary Dimensions of Radial Bearings(Except Tapered Roller Bearings)-Diameter Series 7, 8, 9, 0

Bore Diameter Ref. No.	d	Diameter Series 7					r _{min}	Diameter Series 8					r _{min}				
		Dimension Series			Dimension Series			Dimension Series			Dimension Series		Dimension Series				
		17	27	37	17-37	08		18	28	38	48	58	68	08	18-68		
-	0.6	2	0.8	-	-	0.05	2.5	-	1	-	1.4	-	-	-	-	0.05	
1	1	2.5	1	-	-	0.05	3	-	1	-	1.5	-	-	-	-	0.05	
-	1.5	3	1	-	1.8	0.05	4	-	1.2	-	2	-	-	-	-	0.05	
2	2	4	1.2	-	2	0.05	5	-	1.5	-	2.3	-	-	-	-	0.08	
-	2.5	5	1.5	-	2.3	0.08	6	-	1.8	-	2.6	-	-	-	-	0.08	
3	3	6	2	2.5	3	0.08	7	-	2	-	3	-	-	-	-	0.1	
4	4	7	2	2.5	3	0.08	9	-	2.5	3.5	4	-	-	-	-	0.1	
5	5	8	2	2.5	3	0.08	11	-	3	4	5	-	-	-	-	0.15	
6	6	10	2.5	3	3.5	0.1	13	-	3.5	5	6	-	-	-	-	0.15	
7	7	11	2.5	3	3.5	0.1	14	-	3.5	5	6	-	-	-	-	0.15	
8	8	12	2.5	-	3.5	0.1	16	-	4	5	6	8	-	-	-	0.2	
9	9	14	3	-	4.5	0.1	17	-	4	5	6	8	-	-	-	0.2	
00	10	15	3	-	4.5	0.1	19	-	5	6	7	9	-	-	-	0.3	
01	12	18	4	-	5	0.2	21	-	5	6	7	9	-	-	-	0.3	
02	15	21	4	-	5	0.2	24	-	5	6	7	9	-	-	-	0.3	
03	17	23	4	-	5	0.2	26	-	5	6	7	9	-	-	-	0.3	
04	20	27	4	-	5	0.2	32	4	7	8	10	12	16	22	0.3	0.3	
/22	22	-	-	-	-	-	34	4	7	-	10	-	16	22	0.3	0.3	
05	25	32	4	-	5	0.2	37	4	7	8	10	12	16	22	0.3	0.3	
/28	28	37	-	-	-	-	40	4	7	-	10	-	16	22	0.3	0.3	
06	30	-	4	-	-	0.2	42	4	7	8	10	12	16	22	0.3	0.3	
/32	32	-	-	-	-	-	44	4	7	-	10	-	16	22	0.3	0.3	
07	35	-	-	-	-	-	47	4	7	8	10	12	16	22	0.3	0.3	
08	40	-	-	-	-	-	52	4	7	8	10	12	16	22	0.3	0.3	
09	45	-	-	-	-	-	58	4	7	8	10	13	18	23	0.3	0.3	
10	50	-	-	-	-	-	65	5	7	10	12	15	20	27	0.3	0.3	
11	55	-	-	-	-	-	72	7	9	11	13	17	23	30	0.3	0.3	
12	60	-	-	-	-	-	78	7	10	12	14	18	24	32	0.3	0.3	
13	65	-	-	-	-	-	85	7	10	13	15	20	27	36	0.3	0.6	
14	70	-	-	-	-	-	90	8	10	13	15	20	27	36	0.3	0.6	
15	75	-	-	-	-	-	95	8	10	13	15	20	27	36	0.3	0.6	
16	80	-	-	-	-	-	100	8	10	13	15	20	27	36	0.3	0.6	
17	85	-	-	-	-	-	110	9	13	16	19	25	34	45	0.3	1	
18	90	-	-	-	-	-	115	9	13	16	19	25	34	45	0.3	1	
19	95	-	-	-	-	-	120	9	13	16	19	25	34	45	0.3	1	
20	100	-	-	-	-	-	125	9	13	16	19	25	34	45	0.3	1	
21	105	-	-	-	-	-	130	9	13	16	19	25	34	45	0.3	1	
22	110	-	-	-	-	-	140	10	16	19	23	30	40	54	0.6	1	
24	120	-	-	-	-	-	150	10	16	19	23	30	40	54	0.6	1	
26	130	-	-	-	-	-	165	11	18	22	26	35	46	63	0.6	1.1	
28	140	-	-	-	-	-	175	11	18	22	26	35	46	63	0.6	1.1	
30	150	-	-	-	-	-	190	13	20	24	30	40	54	71	0.6	1.1	
32	160	-	-	-	-	-	200	13	20	24	30	40	54	71	0.6	1.1	
34	170	-	-	-	-	-	215	14	22	27	34	45	60	80	0.6	1.1	
36	180	-	-	-	-	-	225	14	22	27	34	45	60	80	0.6	1.1	
38	190	-	-	-	-	-	240	16	24	30	37	50	67	90	1	1.5	
40	200	-	-	-	-	-	250	16	24	30	37	50	67	90	1	1.5	
44	220	-	-	-	-	-	270	16	24	30	37	50	67	90	1	1.5	
48	240	-	-	-	-	-	300	19	28	36	45	60	80	109	1	2	
52	260	-	-	-	-	-	320	19	28	36	45	60	80	109	1	2	
56	280	-	-	-	-	-	350	22	33	42	52	69	95	125	1.1	2	

Unit : mm

Diameter Series 9									Diameter Series 0									d	Bore Diameter Ref. No.		
Dimension Series									Dimension Series											r _{min}	
09	19	29	39	49	59	69	09	19-39	49-69	00	10	20	30	40	50	60	00			10-60	
4	-	-	-	-	-	-	-	-	-	-	-	-	-	-	-	-	-	-	0.6	-	
5	-	1.6	-	2.3	-	-	-	0.1	-	-	-	-	-	-	-	-	-	-	1	1	
	-	2	-	2.6	-	-	-	0.15	-	6	-	2.5	-	3	-	-	-	0.15	1.5	-	
6	-	2.3	-	3	-	-	-	0.15	-	7	-	2.8	-	3.5	-	-	-	0.15	2	2	
7	-	2.5	-	3.5	-	-	-	0.15	-	8	-	2.8	-	4	-	-	-	0.15	2.5	-	
8	-	3	-	4	-	-	-	0.15	-	9	-	3	-	5	-	-	-	0.15	3	3	
11	-	4	-	5	-	-	-	0.15	-	12	-	4	-	6	-	-	-	0.2	4	4	
13	-	4	-	6	10	-	-	0.2	0.15	14	-	5	-	7	-	-	-	0.2	5	5	
15	-	5	-	7	10	-	-	0.2	0.15	17	-	6	-	9	-	-	-	0.3	6	6	
17	-	5	-	7	10	-	-	0.3	0.15	19	-	6	8	10	-	-	-	0.3	7	7	
19	-	6	-	9	11	-	-	0.3	0.2	22	-	7	9	11	-	-	-	0.3	8	8	
20	-	6	-	9	11	-	-	0.3	0.3	24	-	7	10	12	14	15	20	0.3	9	9	
22	-	6	8	10	13	16	22	-	0.3	0.3	26	-	8	10	12	16	21	0.3	10	00	
24	-	6	8	10	13	16	22	-	0.3	0.3	26	7	8	10	12	16	21	0.3	10	01	
28	-	7	8.5	10	13	18	23	-	0.3	0.3	32	8	9	11	13	17	23	0.3	12	02	
30	-	7	8.5	10	13	18	23	-	0.3	0.3	35	8	10	12	14	18	24	0.3	17	03	
37	7	9	11	13	17	23	30	0.3	0.3	42	8	12	14	16	22	30	40	0.3	20	04	
39	7	9	11	13	17	23	30	0.3	0.3	44	8	12	14	16	22	30	40	0.3	22	04	
																			20	/22	
42	7	9	11	13	17	23	30	0.3	0.3	47	8	12	14	16	22	30	40	0.3	25	05	
45	7	9	11	13	17	23	30	0.3	0.3	52	8	12	14	16	22	30	40	0.3	28	/28	
47	7	9	11	13	17	23	30	0.3	0.3	55	9	13	16	19	25	34	45	0.3	30	06	
52	7	10	13	15	20	27	36	0.3	0.6	58	9	13	16	20	26	35	47	0.3	32	/32	
55	7	10	13	15	20	27	36	0.3	0.6	62	9	14	17	20	27	36	48	0.3	35	07	
62	8	12	14	16	22	30	40	0.3	0.6	66	9	15	18	21	28	38	50	0.3	40	08	
68	8	12	14	16	22	30	40	0.3	0.6	75	10	16	19	23	30	40	54	0.6	45	09	
72	8	12	14	16	22	30	40	0.3	0.6	80	10	16	19	23	30	40	54	0.6	50	10	
80	9	13	16	19	25	34	45	0.3	1	90	11	18	22	26	35	46	63	0.6	55	11	
85	9	13	16	19	25	34	45	0.3	1	95	11	18	22	26	35	46	63	0.6	60	12	
90	9	13	16	19	25	34	45	0.3	1	100	11	18	22	26	35	46	63	0.6	65	13	
100	10	16	19	23	30	40	54	0.6	1	110	13	20	24	30	40	54	71	0.6	70	14	
105	10	16	19	23	30	40	54	0.6	1	115	13	20	24	30	40	54	71	0.6	75	15	
110	10	16	19	23	30	40	54	0.6	1	125	14	22	27	34	45	60	80	0.6	80	16	
120	11	18	22	26	35	46	63	0.6	1.1	130	14	22	27	34	45	60	80	0.6	85	17	
125	11	18	22	26	35	46	63	0.6	1.1	140	16	24	30	37	50	67	90	1	90	18	
130	11	18	22	26	35	46	63	0.6	1.1	145	16	24	30	37	50	67	90	1	95	19	
140	13	20	24	30	40	54	71	0.6	1.1	150	16	24	30	37	50	67	90	1	100	20	
145	13	20	24	30	40	54	71	0.6	1.1	160	18	26	33	41	56	75	100	1	105	21	
150	13	20	24	30	40	54	71	0.6	1.1	170	19	28	36	45	60	80	109	1	110	22	
165	14	22	27	34	45	60	80	0.6	1.1	180	19	28	36	46	60	80	109	1	120	24	
180	16	24	30	37	50	67	90	1	1.5	200	22	33	42	52	69	95	125	1.1	130	26	
190	16	24	30	37	50	67	90	1	1.5	210	22	33	42	53	69	95	125	1.1	140	28	
210	19	28	36	45	60	80	109	1	2	225	24	35	45	56	75	100	136	1.1	150	30	
220	19	28	36	45	60	80	109	1	2	240	25	38	48	60	80	109	145	1.5	160	32	
230	19	28	36	45	60	80	109	1	2	260	28	42	54	67	90	122	160	1.5	170	34	
250	22	33	42	52	69	95	125	1.1	2	280	31	46	60	74	100	136	180	2	180	36	
260	22	33	42	52	69	95	125	1.1	2	290	31	46	60	75	100	136	180	2	190	38	
280	25	38	48	60	80	109	145	1.5	2.1	310	34	51	66	82	109	150	200	2	200	40	
300	25	38	48	60	80	109	145	1.5	2.1	340	37	56	72	90	118	160	218	2.1	220	44	
320	25	38	48	60	80	109	145	1.5	2.1	360	37	56	72	92	118	160	218	2.1	240	48	
360	31	46	60	75	100	136	180	2	2.1	400	44	65	82	104	140	190	250	3	260	52	
380	31	46	60	75	100	136	180	2	2.1	420	44	65	82	106	140	190	250	3	280	56	

6. Boundary Dimensions and Designated Numbering System

Bore Diameter Ref. No.	d	Diameter Series 7					r _{min}	Diameter Series 8									r _{min}	
		Dimension Series			Dimension Series			Dimension Series			Dimension Series			Dimension Series				
		17	27	37	17-37	08		18	28	38	48	58	68	08	18-68			
		D	B		D	B			D	B		D	B		D	B		
60	300	-	-	-	-	-	380	25	38	48	60	80	109	145	1.5	2.1		
64	320	-	-	-	-	-	400	25	38	48	60	80	109	145	1.5	2.1		
68	340	-	-	-	-	-	420	25	38	48	60	80	109	145	1.5	2.1		
72	360	-	-	-	-	-	440	25	38	48	60	80	109	145	1.5	2.1		
76	380	-	-	-	-	-	480	31	46	60	75	100	136	180	2	2.1		
80	400	-	-	-	-	-	500	31	46	60	75	100	136	180	2	2.1		
84	420	-	-	-	-	-	520	31	46	60	75	100	136	180	2	2.1		
88	440	-	-	-	-	-	540	31	46	60	75	100	136	180	2	2.1		
92	460	-	-	-	-	-	580	37	56	72	90	118	160	218	2.1	3		
96	480	-	-	-	-	-	600	37	56	72	90	118	160	218	2.1	3		
/500	500	-	-	-	-	-	620	37	56	72	90	118	160	218	2.1	3		
/530	530	-	-	-	-	-	650	37	56	72	90	118	160	218	2.1	3		
/560	560	-	-	-	-	-	680	37	56	72	90	118	160	218	2.1	3		
/600	600	-	-	-	-	-	730	42	60	78	98	128	175	236	3	3		
/630	630	-	-	-	-	-	780	48	69	88	112	150	200	272	3	4		
/670	670	-	-	-	-	-	820	48	69	88	112	150	200	272	3	4		
/710	710	-	-	-	-	-	870	50	74	95	118	160	218	290	4	4		
/750	750	-	-	-	-	-	920	54	78	100	128	170	230	308	4	5		
/800	800	-	-	-	-	-	980	57	82	106	136	180	243	325	4	5		
/850	850	-	-	-	-	-	1030	57	82	106	136	180	243	325	4	5		
/900	900	-	-	-	-	-	1090	60	85	112	140	190	258	345	5	5		
/950	950	-	-	-	-	-	1150	63	90	118	150	200	272	355	5	5		
/1000	1000	-	-	-	-	-	1220	71	100	128	165	218	300	400	5	6		
/1060	1060	-	-	-	-	-	1280	71	100	128	165	218	300	400	5	6		
/1120	1120	-	-	-	-	-	1360	78	106	140	180	243	325	438	5	6		
/1180	1180	-	-	-	-	-	1420	78	106	140	180	243	325	438	5	6		
/1250	1250	-	-	-	-	-	1500	80	112	145	185	250	335	450	6	6		
/1320	1320	-	-	-	-	-	1600	88	122	165	206	280	375	500	6	6		
/1400	1400	-	-	-	-	-	1700	95	132	175	224	300	400	545	6	7.5		
/1500	1500	-	-	-	-	-	1820	-	140	185	243	315	-	-	-	7.5		
/1600	1600	-	-	-	-	-	1950	-	155	200	265	345	-	-	-	7.5		
/1700	1700	-	-	-	-	-	2060	-	160	206	272	355	-	-	-	7.5		
/1800	1800	-	-	-	-	-	2180	-	165	218	290	375	-	-	-	9.5		
/1900	1900	-	-	-	-	-	2300	-	175	230	300	400	-	-	-	9.5		
/2000	2000	-	-	-	-	-	2430	-	190	250	325	425	-	-	-	9.5		

Note :

1. Chamfer dimensions comply with KS B 2013.
2. Chamfer dimensions in this Table are not necessarily applied to the following corners.
 - ① Corner on the side of raceway where snap ring groove is.
 - ② Corner on the side of thin-walled cylindrical roller bearing where no shoulder exists.
 - ③ Corner on the front side of raceway of angular contact ball bearing.
 - ④ Corner on the inner ring of tapered bore bearing.

Unit : mm

D		Bore Diameter Series 9							r _{min}			D		Bore Diameter Series 0							r _{min}		d	Bore Diameter Ref. No.
Dimension Series		Dimension Series							Dimension Series			Dimension Series		Dimension Series							Dimension Series			
	09	19	29	39	49	59	69	09	19-39	49-69		00	10	20	30	40	50	60	00	10-60				
420	37	56	72	90	118	160	218	2.1	3	3	460	50	74	95	118	160	218	290	4	4	300	60		
440	37	56	72	90	118	160	218	2.1	3	3	480	50	74	95	121	160	218	290	4	4	320	64		
460	37	56	72	90	118	160	218	2.1	3	3	520	57	82	106	133	180	243	325	4	5	340	68		
480	37	56	72	90	118	160	218	2.1	3	3	540	57	82	106	134	180	243	325	4	5	360	72		
520	44	65	82	106	140	190	250	3	4	4	560	57	82	106	135	180	243	325	4	5	380	76		
540	44	65	82	106	140	190	250	3	4	4	600	63	90	118	148	200	272	355	5	5	400	80		
560	44	65	82	106	140	190	250	3	4	4	620	63	90	118	150	200	272	355	5	5	420	84		
600	50	74	95	118	160	218	290	4	4	4	650	67	94	122	157	212	280	375	5	6	440	88		
620	50	74	95	118	160	218	290	4	4	4	680	71	100	128	163	218	300	400	5	6	460	92		
650	54	78	100	128	170	230	308	4	5	5	700	71	100	128	165	218	300	400	5	6	480	96		
800	54	78	100	128	170	230	308	4	5	5	720	71	100	128	167	218	300	400	5	6	500	/500		
710	57	82	106	136	180	243	325	4	5	5	780	80	112	145	185	250	335	450	6	6	530	/530		
750	60	85	112	140	190	258	345	5	5	5	820	82	115	150	195	258	355	462	6	6	560	/560		
800	63	90	118	150	200	272	355	5	5	5	870	85	118	155	200	272	365	488	6	6	600	/600		
850	71	100	128	165	218	300	400	5	6	6	920	92	128	170	212	290	388	515	6	7.5	630	/630		
900	73	103	136	170	230	308	412	5	6	6	980	100	136	180	230	308	425	560	6	7.5	670	/670		
950	78	106	140	180	243	325	438	5	6	6	1030	103	140	185	236	315	438	580	6	7.5	710	/710		
1000	80	112	145	185	250	335	450	6	6	6	1090	109	150	195	250	335	462	615	7.5	7.5	750	/750		
1060	82	115	150	195	258	355	462	6	6	6	1150	112	155	200	258	345	475	630	7.5	7.5	800	/800		
1120	85	118	155	200	272	365	488	6	6	6	1220	118	165	212	272	365	500	670	7.5	7.5	850	/850		
1180	88	122	165	206	280	375	500	6	6	6	1280	122	170	218	280	375	515	690	7.5	7.5	900	/900		
1250	96	132	175	224	300	400	545	6	7.5	7.5	1360	132	180	236	300	412	560	730	7.5	7.5	950	/950		
1320	103	140	185	236	315	438	580	6	7.5	7.5	1420	136	185	243	308	412	560	750	7.5	7.5	1000	/1000		
1400	109	150	195	250	335	462	615	7.5	7.5	7.5	1500	140	195	250	325	438	600	800	9.5	9.5	1060	/1060		
1460	109	150	195	250	335	462	615	7.5	7.5	7.5	1580	145	200	265	345	462	615	825	9.5	9.5	1120	/1120		
1540	115	160	206	272	355	488	650	7.5	7.5	7.5	1660	155	212	272	355	475	650	875	9.5	9.5	1180	/1180		
1630	122	170	218	280	375	515	690	7.5	7.5	7.5	1750	-	218	290	375	500	-	-	-	9.5	9.5	1250	/1250	
1720	128	175	230	300	400	545	710	7.5	7.5	7.5	1850	-	230	300	400	530	-	-	-	12	12	1320	/1320	
1820	-	185	243	315	425	-	-	-	9.5	9.5	1950	-	243	315	412	545	-	-	-	-	12	1400	/1400	
1950	-	195	258	335	450	-	-	-	9.5	9.5	2120	-	272	355	462	615	-	-	-	-	12	1500	/1500	
2060	-	200	265	345	462	-	-	-	9.5	9.5	2240	-	280	365	475	630	-	-	-	-	12	1600	/1600	
2180	-	212	280	355	475	-	-	-	9.5	9.5	2360	-	290	375	500	650	-	-	-	-	15	1700	/1700	
2300	-	218	290	375	500	-	-	-	12	12	2500	-	308	400	530	690	-	-	-	-	15	1800	/1800	
2430	-	230	308	400	530	-	-	-	-	-	-	-	-	-	-	-	-	-	-	-	-	1900	/1900	
-	-	-	-	-	-	-	-	-	-	-	-	-	-	-	-	-	-	-	-	-	-	2000	/2000	

6. Boundary Dimensions and Designated Numbering System

Table 6-2 Boundary Dimensions of Radial Bearings(Except Tapered Roller Bearings)-Diameter Series 1, 2, 3, 4

Bore Diameter Ref. No.	d	Diameter Series 1						r _{min}		Diameter Series 2						r _{min}	
		Dimension Series						Dimension Series		Dimension Series						Dimension Series	
		01	11	21	31	41	01	11-41	82	02	12	22	32	42	82	02-42	
-	0.6	-	-	-	-	-	-	-	-	-	-	-	-	-	-	-	
1	1.1	-	-	-	-	-	-	-	-	-	-	-	-	-	-	-	
-	1.5	-	-	-	-	-	-	-	-	-	-	-	-	-	-	-	
2	2	-	-	-	-	-	-	-	-	-	-	-	-	-	-	-	
-	2.5	-	-	-	-	-	-	-	-	-	-	-	-	-	-	-	
3	3	-	-	-	-	-	-	-	10	2.5	4	-	-	5	-	0.1	
4	4	-	-	-	-	-	-	-	13	3	5	-	-	7	-	0.15	
5	5	-	-	-	-	-	-	-	16	3.5	5	-	-	8	-	0.15	
6	6	-	-	-	-	-	-	-	19	4	6	-	-	10	-	0.2	
7	7	-	-	-	-	-	-	-	22	5	7	-	-	11	-	0.3	
8	8	-	-	-	-	-	-	-	24	5	8	-	-	12	-	0.3	
9	9	-	-	-	-	-	-	-	26	6	8	-	-	13	-	0.3	
00	10	-	-	-	-	-	-	-	30	7	9	-	14	14.3	-	0.3	
01	12	-	-	-	-	-	-	-	32	7	10	-	14	15.9	-	0.3	
02	15	-	-	-	-	-	-	-	35	8	11	-	14	15.9	20	0.3	
03	17	-	-	-	-	-	-	-	40	8	12	-	16	17.5	22	0.3	
04	20	-	-	-	-	-	-	-	47	9	14	-	18	20.6	27	0.3	
/22	22	-	-	-	-	-	-	-	50	9	14	-	18	20.6	27	0.3	
05	25	-	-	-	-	-	-	-	52	10	15	-	18	20.6	27	0.3	
/28	28	-	-	-	-	-	-	-	58	10	16	-	19	23	30	0.6	
06	30	-	-	-	-	-	-	-	62	10	16	-	20	23.8	32	0.6	
/32	32	-	-	-	-	-	-	-	65	11	17	-	21	25	33	0.6	
07	35	-	-	-	-	-	-	-	72	12	17	-	23	27	37	0.6	
08	40	-	-	-	-	-	-	-	80	13	18	-	23	30.2	40	0.6	
09	45	-	-	-	-	-	-	-	85	13	19	-	23	30.2	40	0.6	
10	50	-	-	-	-	-	-	-	90	13	20	-	23	30.2	40	0.6	
11	55	-	-	-	-	-	-	-	100	14	21	-	25	33.3	45	0.6	
12	60	-	-	-	-	-	-	-	110	16	22	-	28	36.5	50	1	
13	65	-	-	-	-	-	-	-	120	18	23	-	31	38.1	56	1	
14	70	-	-	-	-	-	-	-	125	18	24	-	31	39.7	56	1	
15	75	-	-	-	-	-	-	-	130	18	25	-	31	41.3	56	1	
16	80	-	-	-	-	-	-	-	140	19	26	-	33	44.4	60	1	
17	85	-	-	-	-	-	-	-	150	21	28	-	36	49.2	65	1.1	
18	90	150	-	-	-	60	-	2	160	22	30	-	40	52.4	69	1.1	
19	95	160	-	-	-	65	-	2	170	24	32	-	43	55.6	75	1.1	
20	100	165	21	30	39	52	65	1.1	2	180	25	34	-	46	60.3	80	1.5
21	105	175	22	33	42	56	69	1.1	2	190	27	36	-	50	65.1	85	1.5
22	110	180	22	33	42	56	69	1.1	2	200	28	38	-	53	69.8	90	1.5
24	120	200	25	38	48	62	80	1.5	2	215	-	40	42	58	76	95	-
26	130	210	25	38	48	64	80	1.5	2	230	-	40	46	64	80	100	-
28	140	225	27	40	50	68	85	1.5	2.1	250	-	42	50	68	88	109	-
30	150	250	31	46	60	80	100	2	2.1	270	-	45	54	73	96	118	-
32	160	270	34	51	66	86	109	2	2.1	290	-	48	58	80	104	128	-
34	170	280	34	51	66	88	109	2	2.1	310	-	52	62	86	110	140	-
36	180	300	37	56	72	96	118	2.1	3	320	-	52	62	86	112	140	-
38	190	320	42	60	78	104	128	3	3	340	-	55	65	92	120	150	-
40	200	340	44	65	82	112	140	3	3	360	-	58	70	98	128	160	-
44	220	370	48	69	88	120	150	3	4	400	-	65	78	108	144	180	-
48	240	400	50	74	95	128	160	4	4	440	-	72	85	120	160	200	-
52	260	440	57	82	106	144	180	4	4	480	-	80	90	130	174	218	-
56	280	460	57	82	106	146	180	4	5	500	-	80	90	130	176	218	-

Unit : mm

D	B					r _{min}		D	B			r _{min}	d	Bore Diameter Ref. No.	
	Diameter Series 3					Dimension Series			Diameter Series 4						Dimension Series
	83	03	13	23	33	83	03~33		04	24	04~24				
-	-	-	-	-	-	-	-	-	-	-	-	0.6	-		
-	-	-	-	-	-	-	-	-	-	-	-	1.1	1		
-	-	-	-	-	-	-	-	-	-	-	-	1.5	-		
-	-	-	-	-	-	-	-	-	-	-	-	2	2		
-	-	-	-	-	-	-	-	-	-	-	-	2.5	-		
13	-	5	-	-	7	-	0.2	-	-	-	-	3	3		
16	-	5	-	-	9	-	0.3	-	-	-	-	4	4		
19	-	6	-	-	10	-	0.3	-	-	-	-	5	5		
22	-	7	-	11	13	-	0.3	-	-	-	-	6	6		
26	-	9	-	13	15	-	0.3	-	-	-	-	7	7		
28	-	9	-	13	15	-	0.3	30	10	14	0.6	8	8		
30	-	10	-	14	16	-	0.6	32	11	15	0.6	9	9		
35	9	11	-	17	19	0.3	0.6	37	12	16	0.6	10	00		
37	9	12	-	17	19	0.3	1	42	13	19	1	12	01		
42	9	13	-	17	19	0.3	1	52	15	24	1.1	15	02		
47	10	14	-	19	22.2	0.6	1	62	17	29	1.1	17	03		
52	10	15	-	21	22.2	0.6	1.1	72	19	33	1.1	20	04		
56	11	16	-	21	25	0.6	1.1	-	-	-	-	22	/22		
62	12	17	-	24	25.4	0.6	1.1	80	21	36	1.5	25	05		
68	13	18	-	24	30	0.6	1.1	-	-	-	-	28	/28		
72	13	19	-	27	30.2	0.6	1.1	90	23	40	1.5	30	06		
75	14	20	-	28	32	0.6	1.1	-	-	-	-	32	/32		
80	14	21	-	31	34.9	0.6	1.1	100	25	43	1.5	35	07		
90	16	23	-	33	36.5	1	1.5	110	27	46	2	40	08		
100	17	25	-	36	39.7	1	1.5	120	29	50	2	45	09		
110	19	27	-	40	44.4	1	2	130	31	53	2.1	50	10		
120	21	29	-	43	49.2	1.1	2	140	33	57	2.1	55	11		
130	22	31	-	46	54	1.1	2.1	150	35	60	2.1	60	12		
140	24	33	-	48	58.7	1.1	2.1	160	37	64	2.1	65	13		
150	25	35	-	51	63.5	1.5	2.1	180	42	74	3	70	14		
160	27	37	-	55	68.3	1.5	2.1	190	45	77	3	75	15		
170	28	39	-	58	68.3	1.5	2.1	200	48	80	3	80	16		
180	30	41	-	60	73	2	3	210	52	86	4	85	17		
190	30	43	-	64	73	2	3	225	54	90	4	90	18		
200	33	45	-	67	77.8	2	3	240	55	95	4	95	19		
215	36	47	51	73	82.6	2.1	3	250	58	98	4	100	20		
225	37	49	53	77	87.3	2.1	3	260	60	100	4	105	21		
240	42	50	57	80	92.1	3	3	280	65	108	4	110	22		
260	44	55	62	86	106	3	3	310	72	118	5	120	24		
280	48	58	66	93	112	3	4	340	78	128	5	130	26		
300	50	62	70	102	118	4	4	360	82	132	5	140	28		
320	-	65	75	108	128	-	4	380	85	138	5	150	30		
340	-	68	79	114	136	-	4	400	88	142	5	160	32		
360	-	72	84	120	140	-	4	420	92	145	5	170	34		
380	-	75	88	126	150	-	4	440	95	150	6	180	36		
400	-	78	92	132	155	-	5	460	98	155	6	190	38		
420	-	80	97	138	165	-	5	480	102	160	6	200	40		
460	-	88	106	145	180	-	5	540	115	180	6	220	44		
500	-	95	114	155	195	-	5	580	122	190	6	240	48		
540	-	102	123	165	206	-	6	620	132	206	7.5	260	52		
580	-	108	132	175	224	-	6	670	140	224	7.5	280	56		

6. Boundary Dimensions and Designated Numbering System

Bore Diameter Ref. No.	d	Diameter Series 1							Diameter Series 2									
		Dimension Series					Dimension Series		Dimension Series					Dimension Series				
		01 11 21 31 41					01 11-41		82 02 12 22 32 42					82 02-42				
		D	B				r _{min}		D	B				r _{min}				
60	300	500	63	90	118	160	200	5	5	540	-	85	98	140	192	243	-	5
64	320	540	71	100	128	176	218	5	5	580	-	92	105	150	208	258	-	5
68	340	580	78	106	140	190	243	5	5	620	-	92	118	165	224	280	-	6
72	360	600	78	106	140	192	243	5	5	650	-	95	122	170	232	290	-	6
76	380	620	78	106	140	194	243	5	5	680	-	95	132	175	240	300	-	6
80	400	650	80	112	145	200	250	6	6	720	-	103	140	185	256	315	-	6
84	420	700	88	122	165	224	280	6	6	760	-	109	150	195	272	335	-	7.5
88	440	720	88	122	165	226	280	6	6	790	-	112	155	200	280	345	-	7.5
92	460	760	95	132	175	240	300	6	7.5	830	-	118	165	212	296	365	-	7.5
96	480	790	100	136	180	248	308	6	7.5	870	-	125	170	224	310	388	-	7.5
/500	500	830	106	145	190	264	325	7.5	7.5	920	-	136	185	243	336	412	-	7.5
/530	530	870	109	150	195	272	335	7.5	7.5	980	-	145	200	258	355	450	-	9.5
/560	560	920	115	160	206	280	335	7.5	7.5	1030	-	150	206	272	365	475	-	9.5
/600	600	980	122	170	218	300	375	7.5	7.5	1090	-	155	212	280	388	488	-	9.5
/630	630	1030	128	175	230	315	400	7.5	7.5	1150	-	165	230	300	412	515	-	12
/670	670	1090	136	185	243	336	412	7.5	7.5	1220	-	175	243	315	438	545	-	12
/710	710	1150	140	195	250	345	438	9.5	9.5	1280	-	180	250	325	450	560	-	12
/750	750	1220	150	206	272	365	475	9.5	9.5	1360	-	195	265	345	475	615	-	15
/800	800	1280	155	212	272	375	475	9.5	9.5	1420	-	200	272	355	488	615	-	15
/850	850	1360	165	224	290	400	500	12	12	1500	-	206	280	375	515	650	-	15
/900	900	1420	165	230	300	412	515	12	12	1580	-	218	300	388	515	670	-	15
/950	950	1500	175	243	315	438	545	12	12	1660	-	230	315	412	530	710	-	15
/1000	1000	1580	185	258	335	462	580	12	12	1750	-	243	330	425	560	750	-	15
/1060	1060	1660	190	265	345	475	600	12	12	-	-	-	-	-	-	-	-	-
/1120	1120	1750	-	280	365	475	630	-	15	-	-	-	-	-	-	-	-	-
/1180	1180	1850	-	290	388	500	670	-	15	-	-	-	-	-	-	-	-	-
/1250	1250	1950	-	308	400	530	710	-	15	-	-	-	-	-	-	-	-	-
/1320	1320	2060	-	325	425	560	750	-	15	-	-	-	-	-	-	-	-	-
/1400	1400	2180	-	345	450	580	775	-	19	-	-	-	-	-	-	-	-	-
/1500	1500	2300	-	355	462	600	800	-	19	-	-	-	-	-	-	-	-	-

Note :

1. Chamfer dimensions comply with KS B 2013.
2. Chamfer dimensions in this Table are not necessarily applied to the following corners.
 - ① Corner on the side of raceway where snap ring groove is.
 - ② Corner on the side of thin-walled cylindrical roller bearing where no shoulder exists.
 - ③ Corner on the front side of raceway of angular contact ball bearing.
 - ④ Corner on the inner ring of tapered bore bearing.

Unit : mm

D	B					r_{min}	D	B			r_{min}	d	Bore Diameter Ref. No.
	Diameter Series 3							Diameter Series 4					
	Dimension Series							Dimension Series					
83	03	13	23	33	83	03-33	04	24	04-24				
620	-	109	140	185	236	-	7.5	710	150	236	7.5	300	60
670	-	112	155	200	258	-	7.5	750	155	250	9.5	320	64
710	-	118	165	212	272	-	7.5	800	165	265	9.5	340	68
750	-	125	170	224	290	-	7.5	850	180	280	9.5	360	72
780	-	128	175	230	300	-	7.5	900	190	300	9.5	380	76
820	-	136	185	243	308	-	7.5	950	200	315	12	400	80
850	-	136	190	250	315	-	9.5	980	206	325	12	420	84
900	-	145	200	265	345	-	9.5	1030	212	335	12	440	88
950	-	155	212	280	365	-	9.5	1060	218	345	12	460	92
980	-	160	218	290	375	-	9.5	1120	230	365	15	480	96
1030	-	170	230	300	388	-	12	1150	236	375	15	500	/500
1090	-	180	243	325	412	-	12	1220	250	400	15	530	/530
1150	-	190	258	335	438	-	12	1280	258	412	15	560	/560
1220	-	200	272	355	462	-	15	1360	272	438	15	600	/600
1280	-	206	280	375	488	-	15	1420	280	450	15	630	/630
1360	-	218	300	400	515	-	15	1500	290	475	15	670	/670
1420	-	224	308	412	530	-	15	-	-	-	-	710	/710
1500	-	236	325	438	560	-	15	-	-	-	-	750	/750
1600	-	258	355	462	600	-	15	-	-	-	-	800	/800
1700	-	272	375	488	630	-	19	-	-	-	-	850	/850
1780	-	280	388	500	650	-	19	-	-	-	-	900	/900
1850	-	290	400	515	670	-	19	-	-	-	-	950	/950
1950	-	300	412	545	710	-	19	-	-	-	-	1000	/1000
-	-	-	-	-	-	-	-	-	-	-	-	1060	/1060
-	-	-	-	-	-	-	-	-	-	-	-	1120	/1120
-	-	-	-	-	-	-	-	-	-	-	-	1180	/1180
-	-	-	-	-	-	-	-	-	-	-	-	1250	/1250
-	-	-	-	-	-	-	-	-	-	-	-	1320	/1320
-	-	-	-	-	-	-	-	-	-	-	-	1400	/1400
-	-	-	-	-	-	-	-	-	-	-	-	1500	/1500

Unit : mm

D	Diameter Series 2												Diameter Series 3												d	Bore Diameter Ref. No.			
	Dimension Series 02				Dimension Series 22				Dimension Series 32				Dimension Series 03				Dimension Series 13				Dimension Series 23								
	B	C	T	r _{min}	B	C	T	r _{min}	B	C	T	r _{min}	B	C	T	r _{min}	B	C	T	r _{min}	B	C	T	r _{min}			B	C	T
30	9	-	9.7	14	-	14.7	-	-	0.6	0.6	35	11	-	-	11.9	-	-	-	17	-	17.9	0.6	0.6	10	00				
32	10	9	10.75	14	-	14.75	-	-	0.6	0.6	37	12	-	-	12.9	-	-	-	17	-	17.9	1	1	12	01				
35	11	10	11.75	14	-	14.75	-	-	0.6	0.6	42	13	11	-	14.25	-	-	-	17	14	18.25	1	1	15	02				
40	12	11	13.25	16	14	17.25	-	-	1	1	47	14	12	-	15.25	-	-	-	19	16	20.25	1	1	17	03				
47	14	12	15.25	18	15	19.25	-	-	1	1	52	15	13	-	16.25	-	-	-	21	18	22.25	1.5	1.5	20	04				
50	14	12	15.25	18	15	19.25	-	-	1	1	56	16	14	-	17.25	-	-	-	21	18	22.25	1.5	1.5	22	04 /22				
52	15	13	16.25	18	15	19.25	22	18	22	1	1	62	17	15	13	18.25	-	-	24	20	25.25	1.5	1.5	25	05				
58	16	14	17.25	19	16	20.25	24	19	24	1	1	68	18	15	14	19.75	-	-	24	20	25.75	1.5	1.5	28	/28				
62	16	14	17.25	20	17	21.25	25	19.5	25	1	1	72	19	16	14	20.75	-	-	27	23	28.75	1.5	1.5	30	06				
65	17	15	18.25	21	18	22.25	26	20.5	26	1	1	75	20	17	15	21.75	-	-	28	24	29.75	1.5	1.5	32	/32				
72	17	15	18.25	23	19	24.25	28	22	28	1.5	1.5	80	21	18	15	22.75	-	-	31	25	32.75	2	2	35	07				
80	18	16	19.75	23	19	24.75	32	25	32	1.5	1.5	90	23	20	17	25.25	-	-	33	27	35.25	2	2	40	08				
85	19	16	20.75	23	19	24.75	32	25	32	1.5	1.5	100	25	22	18	27.25	-	-	36	30	38.25	2	2	45	09				
90	20	17	21.75	23	19	24.75	32	24.5	32	1.5	1.5	110	27	23	19	29.25	-	-	40	33	42.25	2.5	2.5	50	10				
100	21	18	22.75	25	21	26.75	35	27	35	2	2	120	29	25	21	31.5	-	-	43	35	45.5	2.5	2.5	55	11				
110	22	19	23.75	28	24	29.75	38	29	38	2	1.5	130	31	26	22	33.5	-	-	46	37	48.5	3	3	60	12				
120	23	20	24.75	31	27	32.75	41	32	41	2	1.5	140	33	28	23	36	-	-	48	39	51	3	2.5	65	13				
125	24	21	26.25	31	27	33.25	41	32	41	2	1.5	150	35	30	25	38	-	-	51	42	54	3	2.5	70	14				
130	25	22	27.25	31	27	33.25	41	31	41	2	1.5	160	37	31	26	40	-	-	55	45	58	3	2.5	75	15				
140	26	22	28.25	33	28	35.25	46	35	46	2.5	2	170	39	33	27	42.5	-	-	58	48	61.5	3	2.5	80	16				
150	28	24	30.5	36	30	38.5	49	37	49	2.5	2	180	41	34	28	44.5	-	-	60	49	63.5	4	3	85	17				
160	30	26	32.5	40	34	42.5	55	42	55	2.5	2	190	43	36	30	46.5	-	-	64	53	67.5	4	3	90	18				
170	32	27	34.5	43	37	45.5	58	44	58	3	2.5	200	45	38	32	49.5	-	-	67	55	71.5	4	3	95	19				
180	34	29	37	46	39	49	63	48	63	3	2.5	215	47	39	-	51.5	51	35	73	60	77.5	4	3	100	20				
190	36	30	39	50	43	53	68	52	68	3	2.5	225	49	41	-	53.5	53	36	77	63	81.5	4	3	105	21				
200	38	32	41	53	46	56	-	-	3	2.5	240	50	42	-	54.5	57	38	58	80	65	84.5	4	3	110	22				
215	40	34	43.5	58	50	61.5	-	-	3	2.5	260	55	46	-	59.5	62	42	63	86	69	90.5	4	3	120	24				
230	40	34	43.75	64	54	67.75	-	-	4	3	280	58	49	-	63.75	66	44	68	93	78	98.75	5	4	130	26				
250	42	36	45.75	68	58	71.75	-	-	4	3	300	62	53	-	67.75	70	47	72	102	85	107.75	5	4	140	28				
270	45	38	49	73	60	77	-	-	4	3	320	65	55	-	72	75	50	77	108	90	114	5	4	150	30				
290	48	40	52	80	67	84	-	-	4	3	340	68	58	-	75	79	-	82	114	95	121	5	4	160	32				
310	52	43	57	86	71	91	-	-	5	4	360	72	62	-	80	84	-	87	120	100	127	5	4	170	34				
320	52	43	57	86	71	91	-	-	5	4	380	75	64	-	83	88	-	92	126	106	137	5	4	180	36				
340	55	46	60	92	75	97	-	-	5	4	400	78	65	-	86	92	-	97	132	109	140	6	5	190	38				
360	58	48	64	98	82	104	-	-	5	4	420	80	67	-	89	97	-	101	138	115	146	6	5	200	40				
400	65	54	72	108	90	114	-	-	5	4	460	88	73	-	97	106	-	107	145	122	154	6	5	220	44				
440	72	60	79	120	100	127	-	-	5	4	500	95	80	-	105	114	-	117	155	132	165	6	5	240	48				
480	80	67	89	130	106	137	-	-	6	5	540	102	85	-	113	123	-	125	165	136	176	6	6	260	52				
500	80	67	89	130	106	137	-	-	6	5	580	108	90	-	119	132	-	135	175	145	187	6	6	280	56				
540	85	71	96	140	115	149	-	-	6	5	-	-	-	-	-	-	-	-	-	-	-	-	-	300	60				
580	92	75	104	150	125	159	-	-	6	5	-	-	-	-	-	-	-	-	-	-	-	-	-	320	64				
-	-	-	-	-	-	-	-	-	-	-	-	-	-	-	-	-	-	-	-	-	-	-	-	340	68				
-	-	-	-	-	-	-	-	-	-	-	-	-	-	-	-	-	-	-	-	-	-	-	-	360	72				

Annotations 1) They are applied to the bearings 303D with large contact angles. In DIN, the ones having equivalent dimensions to 303D of KS are designated as 313, and for the bearings with inner diameter larger than 100mm, the ones of dimension series 13 are designated as 313 just like the dimension series.

6. Boundary Dimensions and Designated Numbering System

Table 6-4 Boundary Dimensions of Thrust Bearings(Flat Seat Type)

Bore Diameter Ref. No	d	Diameter Series 0					r _{min}	Diameter Series 1					r _{min}	Diameter Series 2					r _{min}
		Dimension Series			Dimension Series			Dimension Series											
		70	90	10	71	91		11	72	92	12	22							
4	4	12	4	-	6	0.3	-	-	-	-	-	16	6	-	8	-	0.3		
6	6	16	5	-	7	0.3	-	-	-	-	-	20	6	-	9	-	0.3		
8	8	18	5	-	7	0.3	-	-	-	-	-	22	6	-	9	-	0.3		
00	10	20	5	-	7	0.3	24	6	-	9	0.3	26	7	-	11	-	0.6		
01	12	22	5	-	7	0.3	26	6	-	9	0.3	28	7	-	11	-	0.6		
02	15	26	5	-	7	0.3	28	6	-	9	0.3	32	8	-	12	22	0.6		
03	17	28	5	-	7	0.3	30	6	-	9	0.3	35	8	-	12	-	0.6		
04	20	32	6	-	8	0.3	35	7	-	10	0.3	40	9	-	14	26	0.6		
05	25	37	6	-	8	0.3	42	8	-	11	0.6	47	10	-	15	28	0.6		
06	30	42	6	-	8	0.3	47	8	-	11	0.6	52	10	-	16	29	0.6		
07	35	47	6	-	8	0.3	52	8	-	12	0.6	62	12	-	18	34	1		
08	40	52	6	-	9	0.3	60	9	-	13	0.6	68	13	-	19	36	1		
09	45	60	7	-	10	0.3	65	9	-	14	0.6	73	13	-	20	37	1		
10	50	65	7	-	10	0.3	70	9	-	14	0.6	78	13	-	22	39	1		
11	55	70	7	-	10	0.3	78	10	-	16	0.6	90	16	21	25	45	1		
12	60	75	7	-	10	0.3	85	11	-	17	1	95	16	21	26	46	1		
13	65	80	7	-	10	0.3	90	11	-	18	1	100	16	21	27	47	1		
14	70	85	7	-	10	0.3	95	11	-	18	1	105	16	21	27	47	1		
15	75	90	7	-	10	0.3	100	11	-	19	1	110	16	21	27	47	1		
16	80	95	7	-	10	0.3	105	11	-	19	1	115	16	21	28	48	1		
17	85	100	7	-	10	0.3	110	11	-	19	1	125	18	24	31	55	1		
18	90	105	7	-	10	0.3	120	14	-	22	1	135	20	27	35	62	1.1		
20	100	120	9	-	14	0.6	135	16	21	25	1	150	23	30	38	67	1.1		
22	110	130	9	-	14	0.6	145	16	21	25	1	160	23	30	38	67	1.1		
24	120	140	9	-	14	0.6	155	16	21	25	1	170	23	30	39	68	1.1		
26	130	150	9	-	14	0.6	170	18	24	30	1	190	27	36	45	80	1.5		
28	140	160	9	-	14	0.6	180	18	24	31	1	200	27	36	46	81	1.5		
30	150	170	9	-	14	0.6	190	18	24	31	1	215	29	39	50	89	1.5		
32	160	180	9	-	14	0.6	200	18	24	31	1	225	29	39	51	90	1.5		
34	170	190	9	-	14	0.6	215	20	27	34	1.1	240	32	42	55	97	1.5		
36	180	200	9	-	14	0.6	225	20	27	34	1.1	250	32	42	56	98	1.5		
38	190	215	11	-	17	1	240	23	30	37	1.1	270	36	48	62	109	2		
40	200	225	11	-	17	1	250	23	30	37	1.1	280	36	48	62	109	2		
44	220	250	14	-	22	1	270	23	30	37	1.1	300	36	48	63	110	2		
48	240	270	14	-	22	1	300	27	36	45	1.5	340	45	60	78	-	2.1		
52	260	290	14	-	22	1	320	27	36	45	1.5	360	45	60	79	-	2.1		
56	280	310	14	-	22	1	350	32	42	53	1.5	380	45	60	80	-	2.1		
60	300	340	18	24	30	1	380	36	48	62	2	420	54	73	95	-	3		
64	320	360	18	24	30	1	400	36	48	63	2	440	54	73	95	-	3		
68	340	380	18	24	30	1	420	36	48	64	2	460	54	73	96	-	3		
72	360	400	18	24	30	1	440	36	48	65	2	500	63	85	110	-	4		
76	380	420	18	24	30	1	460	36	48	65	2	520	63	85	112	-	4		
80	400	440	18	24	30	1	480	36	48	65	2	540	63	85	112	-	4		
84	420	460	18	24	30	1	500	36	48	65	2	580	73	95	130	-	5		
88	440	480	18	24	30	1	540	45	60	80	2.1	600	73	95	130	-	5		
92	460	500	18	24	30	1	560	45	60	80	2.1	620	73	95	130	-	5		
96	480	520	18	24	30	1	580	45	60	80	2.1	650	78	103	135	-	5		
/500	500	540	18	24	30	1	600	45	60	80	2.1	670	78	103	135	-	5		

Unit: mm

D Diameter	H Series 3				r _{min}	D Diameter	H Series 4				r _{min}	D Diameter	H Series 5		r _{min}	d	Bore Diameter Ref. No
	Dimension Series						Dimension Series						Dimension Series				
	73	93	13	23			74	94	14	24			95				
20	7	-	11	-	0.6	-	-	-	-	-	-	-	-	-	4	4	
24	8	-	12	-	0.6	-	-	-	-	-	-	-	-	-	6	6	
26	8	-	12	-	0.6	-	-	-	-	-	-	-	-	-	8	8	
30	9	-	14	-	0.6	-	-	-	-	-	-	-	-	-	10	00	
32	9	-	14	-	0.6	-	-	-	-	-	-	-	-	-	12	01	
37	10	-	15	-	0.6	-	-	-	-	-	-	-	-	-	15	02	
40	10	-	16	-	0.6	-	-	-	-	-	52	21	1	17	03		
47	12	-	18	-	1	-	-	-	-	-	60	24	1	20	04		
52	12	-	18	34	1	60	16	21	24	45	73	29	1.1	25	05		
60	14	-	21	38	1	70	18	24	28	52	85	34	1.1	30	06		
68	15	-	24	44	1	80	20	27	32	59	100	39	1.1	35	07		
78	17	22	26	49	1	90	23	30	36	65	110	42	1.5	40	08		
85	18	24	28	52	1	100	25	34	39	72	120	45	2	45	09		
95	20	27	31	58	1.1	110	27	36	43	78	135	51	2	50	10		
105	23	30	35	64	1.1	120	29	39	48	87	150	58	2.1	55	11		
110	23	30	35	64	1.1	130	32	42	51	93	160	60	2.1	60	12		
115	23	30	36	65	1.1	140	34	45	56	101	2	170	63	2.1	65	13	
125	25	34	40	72	1.1	150	36	48	60	107	2	180	67	3	70	14	
135	27	36	44	79	1.5	160	38	51	65	115	2	190	69	3	75	15	
140	27	36	44	79	1.5	170	41	54	68	120	2.1	200	73	3	80	16	
150	29	39	49	87	1.5	180	42	58	72	128	2.1	215	78	4	85	17	
155	29	39	50	88	1.5	190	45	60	77	135	2.1	225	82	4	90	18	
170	32	42	55	97	1.5	210	50	67	85	150	3	250	90	4	100	20	
190	36	48	63	110	2	230	54	73	95	166	3	270	95	5	110	22	
210	41	54	70	123	2.1	250	58	78	102	177	4	300	109	5	120	24	
225	42	58	75	130	2.1	270	63	85	110	192	4	320	115	5	130	26	
240	45	60	80	140	2.1	280	63	85	112	196	4	340	122	5	140	28	
250	45	60	80	140	2.1	300	67	90	120	209	4	360	125	6	150	30	
270	50	67	87	153	3	320	73	95	130	226	5	380	132	6	160	32	
280	50	67	87	153	3	340	78	103	135	236	5	400	140	6	170	34	
300	54	73	95	165	3	360	82	109	140	245	5	420	145	6	180	36	
320	58	78	105	183	4	380	85	115	150	-	5	440	150	6	190	38	
340	63	85	110	192	4	400	90	122	155	-	5	460	155	7.5	200	40	
360	63	85	112	-	4	420	90	122	160	-	6	500	170	7.5	220	44	
380	63	85	112	-	4	440	90	122	160	-	6	540	180	7.5	240	48	
420	73	95	130	-	5	480	100	132	175	-	6	580	190	9.5	260	52	
440	73	95	130	-	5	520	109	145	190	-	6	620	206	9.5	280	56	
480	82	109	140	-	5	540	109	145	190	-	6	670	224	9.5	300	60	
500	82	109	140	-	5	580	118	155	205	-	7.5	710	236	9.5	320	64	
540	90	122	160	-	5	620	125	170	220	-	7.5	750	243	12	340	68	
560	90	122	160	-	5	640	125	170	220	-	7.5	780	250	12	360	72	
600	100	132	175	-	6	670	132	175	224	-	7.5	820	265	12	380	76	
620	100	132	175	-	6	710	140	185	243	-	7.5	850	272	12	400	80	
650	103	140	180	-	6	730	140	185	243	-	7.5	900	290	15	420	84	
680	109	145	190	-	6	780	155	206	265	-	9.5	950	308	15	440	88	
710	112	150	195	-	6	800	155	206	265	-	9.5	980	315	15	460	92	
730	112	150	195	-	6	850	165	224	290	-	9.5	1000	315	15	480	96	
750	112	150	195	-	6	870	165	224	290	-	9.5	1060	335	15	500	/500	

6. Boundary Dimensions and Designated Numbering System

Bore Diameter Ref. No	d	Diameter Series 0						Diameter Series 1						Diameter Series 2					
		D	H			r _{min}	D	H			r _{min}	D	H				r _{min}		
			Dimension Series					Dimension Series					Dimension Series						
			70	90	10		71	91	11			72	92	12	22				
/530	530	580	23	30	38	1.1	640	50	67	85	3	710	82	109	140	-	5		
/560	560	610	23	30	38	1.1	670	50	67	85	3	750	85	115	150	-	5		
/600	600	650	23	30	38	1.1	710	50	67	85	3	800	90	122	160	-	5		
/630	630	680	23	30	38	1.1	750	54	73	95	3	850	100	132	175	-	6		
/670	670	730	27	36	45	1.5	800	58	78	105	4	900	103	140	180	-	6		
/710	710	780	32	42	53	1.5	850	63	85	112	4	950	109	145	190	-	6		
/750	750	820	32	42	53	1.5	900	67	90	120	4	1000	112	150	195	-	6		
/800	800	870	32	42	53	1.5	950	67	90	120	4	1060	118	155	205	-	7.5		
/850	850	920	32	42	53	1.5	1000	67	90	120	4	1120	122	160	212	-	7.5		
/900	900	980	36	48	63	2	1060	73	95	130	5	1180	125	170	220	-	7.5		
/950	950	1030	36	48	63	2	1120	78	103	135	5	1250	136	180	236	-	7.5		
/1000	1000	1090	41	54	70	2.1	1180	82	109	140	5	1320	145	190	250	-	9.5		
/1060	1060	1150	41	54	70	2.1	1250	85	115	150	5	1400	155	206	265	-	9.5		
/1120	1120	1220	45	60	80	2.1	1320	90	122	160	5	1460	-	206	-	-	9.5		
/1180	1180	1280	45	60	80	2.1	1400	100	132	175	6	1520	-	206	-	-	9.5		
/1250	1250	1360	50	67	85	3	1460	-	-	175	6	1610	-	216	-	-	9.5		
/1320	1320	1440	-	-	95	3	1540	-	-	175	6	1700	-	228	-	-	9.5		
/1400	1400	1520	-	-	95	3	1630	-	-	180	6	1790	-	234	-	-	12		
/1500	1500	1630	-	-	105	4	1750	-	-	195	6	1920	-	252	-	-	12		
/1600	1600	1730	-	-	105	4	1850	-	-	195	6	2040	-	264	-	-	15		
/1700	1700	1840	-	-	112	4	1970	-	-	212	7.5	2160	-	276	-	-	15		
/1800	1800	1950	-	-	120	4	2080	-	-	220	7.5	2280	-	288	-	-	15		
/1900	1900	2060	-	-	130	5	2180	-	-	220	7.5	-	-	-	-	-	-		
/2000	2000	2160	-	-	130	5	2300	-	-	236	7.5	-	-	-	-	-	-		
/2120	2120	2300	-	-	140	5	2430	-	-	243	7.5	-	-	-	-	-	-		
/2240	2240	2430	-	-	150	5	2570	-	-	258	9.5	-	-	-	-	-	-		
/2360	2360	2550	-	-	150	5	2700	-	-	265	9.5	-	-	-	-	-	-		
/2500	2500	2700	-	-	160	5	2850	-	-	272	9.5	-	-	-	-	-	-		

Note :

1. Dimension Series 22, 23, and 24 are for those bearings that can carry loads in both axial directions. (For a bearing that can carry loads in both axial directions, its nominal bore diameter is that of central washer, and in this Table, those values have been omitted.)
2. Both max. permissible outer diameters of shaft/central washers and min. permissible inner diameter of housing washers have been omitted. (Refer to bearing dimension tables for thrust bearings.)

Unit : mm

D Diameter	H Series 3				r _{min}	D	H Series 4				r _{min}	D	H Series 5		r _{min}	d	Bore Diameter Ref. No
	Dimension Series						Dimension Series						Dimension Series				
	73	93	13	23			74	94	14	24			95				
800	122	160	212	-	7.5	920	175	236	308	-	9.5	1090	335	15	530	/530	
850	132	175	224	-	7.5	980	190	250	335	-	12	1150	355	15	560	/560	
900	136	180	236	-	7.5	1030	195	258	335	-	12	1220	375	15	600	/600	
950	145	190	250	-	9.5	1090	206	280	365	-	12	1280	388	15	630	/630	
1000	150	200	258	-	9.5	1150	218	290	375	-	15	1320	388	15	670	/670	
1060	160	212	272	-	9.5	1220	230	308	400	-	15	1400	412	15	710	/710	
1120	165	224	290	-	9.5	1280	236	315	412	-	15	-	-	-	750	/750	
1180	170	230	300	-	9.5	1360	250	335	438	-	15	-	-	-	800	/800	
1250	180	243	315	-	12	1440	-	354	-	-	15	-	-	-	850	/850	
1320	190	250	335	-	12	1520	-	372	-	-	15	-	-	-	900	/900	
1400	200	272	355	-	12	1600	-	390	-	-	15	-	-	-	950	/950	
1460	-	276	-	-	12	1670	-	402	-	-	15	-	-	-	1000	/1000	
1540	-	288	-	-	15	1770	-	426	-	-	15	-	-	-	1060	/1060	
1630	-	306	-	-	15	1860	-	444	-	-	15	-	-	-	1120	/1120	
1710	-	318	-	-	15	1950	-	462	-	-	19	-	-	-	1180	/1180	
1800	-	330	-	-	15	2050	-	480	-	-	19	-	-	-	1250	/1250	
1900	-	348	-	-	19	2160	-	505	-	-	19	-	-	-	1320	/1320	
2000	-	360	-	-	19	2280	-	530	-	-	19	-	-	-	1400	/1400	
2140	-	384	-	-	19	-	-	-	-	-	-	-	-	-	1500	/1500	
2270	-	402	-	-	19	-	-	-	-	-	-	-	-	-	1600	/1600	
-	-	-	-	-	-	-	-	-	-	-	-	-	-	-	1700	/1700	
-	-	-	-	-	-	-	-	-	-	-	-	-	-	-	1800	/1800	
-	-	-	-	-	-	-	-	-	-	-	-	-	-	-	1900	/1900	
-	-	-	-	-	-	-	-	-	-	-	-	-	-	-	2000	/2000	
-	-	-	-	-	-	-	-	-	-	-	-	-	-	-	2120	/2120	
-	-	-	-	-	-	-	-	-	-	-	-	-	-	-	2240	/2240	
-	-	-	-	-	-	-	-	-	-	-	-	-	-	-	2360	/2360	
-	-	-	-	-	-	-	-	-	-	-	-	-	-	-	2500	/2500	

6. Boundary Dimensions and Designated Numbering System

Table 6-5 Dimensions of Snap Ring Groove and Snap Ring - Dimension Series 18, 19

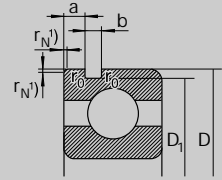

Bearings		Snap Ring Groove									
d	Dimension Series	D	D ₁		a				b		r ₀
			min	max	Diameter Series		19		min	max	min
	18	19			min	max	min	max	min	max	min
-	10	22	20.5	20.8	-	-	0.9	1.05	0.8	1.05	0.2
-	12	24	22.5	22.8	-	-	0.9	1.05	0.8	1.05	0.2
-	15	28	26.4	26.7	-	-	1.15	1.3	0.95	1.2	0.25
-	17	30	28.4	28.7	-	-	1.15	1.3	0.95	1.2	0.25
20	-	32	30.4	30.7	1.15	1.3	-	-	0.95	1.2	0.25
22	-	34	32.4	32.7	1.15	1.3	-	-	0.95	1.2	0.25
25	20	37	35.4	35.7	1.15	1.3	1.55	1.7	0.95	1.2	0.25
-	22	39	37.4	37.7	-	-	1.55	1.7	0.95	1.2	0.25
28	-	40	38.4	38.7	1.15	1.3	-	-	0.95	1.2	0.25
30	25	42	40.4	40.7	1.15	1.3	1.55	1.7	0.95	1.2	0.25
32	-	44	42.4	42.7	1.15	1.3	-	-	0.95	1.2	0.25
-	28	45	43.4	43.7	-	-	1.55	1.7	0.95	1.2	0.25
35	30	47	45.4	45.7	1.15	1.3	1.55	1.7	0.95	1.2	0.25
40	32	52	50.4	50.7	1.15	1.3	1.55	1.7	0.95	1.2	0.25
-	35	55	53.4	53.7	-	-	1.55	1.7	0.95	1.2	0.25
45	-	58	56.4	56.7	1.15	1.3	-	-	0.95	1.2	0.25
-	40	62	60.3	60.7	-	-	1.55	1.7	0.95	1.2	0.25
50	-	65	63.3	63.7	1.15	1.3	-	-	0.95	1.2	0.25
-	45	68	66.3	66.7	-	-	1.55	1.7	0.95	1.2	0.25
55	50	72	70.3	70.7	1.55	1.7	1.55	1.7	0.95	1.2	0.25
60	-	78	75.8	76.2	1.55	1.7	-	-	1.3	1.6	0.4
-	55	80	77.5	77.9	-	-	1.9	2.1	1.3	1.6	0.4
65	60	85	82.5	82.9	1.55	1.7	1.9	2.1	1.3	1.6	0.4
70	65	90	87.5	87.9	1.55	1.7	1.9	2.1	1.3	1.6	0.4
75	-	95	92.5	92.9	1.55	1.7	-	-	1.3	1.6	0.4
80	70	100	97.5	97.9	1.55	1.7	2.3	2.5	1.3	1.6	0.4
-	75	105	102.1	102.6	-	-	2.3	2.5	1.3	1.6	0.4
85	80	110	107.1	107.6	1.9	2.1	2.3	2.5	1.3	1.6	0.4
90	-	115	112.1	112.6	1.9	2.1	-	-	1.3	1.6	0.4
95	85	120	117.1	117.6	1.9	2.1	3.1	3.3	1.3	1.6	0.4
100	90	125	122.1	122.6	1.9	2.1	3.1	3.3	1.3	1.6	0.4
105	95	130	127.1	127.6	1.9	2.1	3.1	3.3	1.3	1.6	0.4
110	100	140	137.1	137.6	2.3	2.5	3.1	3.3	1.9	2.2	0.6
-	105	148	142.1	142.6	-	-	3.1	3.3	1.9	2.2	0.6
120	110	150	147.1	147.6	2.3	2.5	3.1	3.3	1.9	2.2	0.6
130	120	165	161.3	161.8	3.1	3.3	3.5	3.7	1.9	2.2	0.6
140	-	175	171.3	171.8	3.1	3.3	-	-	1.9	2.2	0.6
-	130	180	176.3	176.8	-	-	3.5	3.7	1.9	2.2	0.6
150	140	190	186.3	186.8	3.1	3.3	3.5	3.7	1.9	2.2	0.6
160	-	200	196.3	196.8	3.1	3.3	-	-	1.9	2.2	0.6

1) The min. permissible dimension of chamfer dimension r_N on the snap ring groove side of outer ring is 0.3mm for the bearings with outer diameter smaller than 78mm among the ones of dimension series 18, as well as the

ones with smaller than 47mm in dimension series 19. And it is 0.5mm for all other bearings exceeding 78mm or 47mm limits.

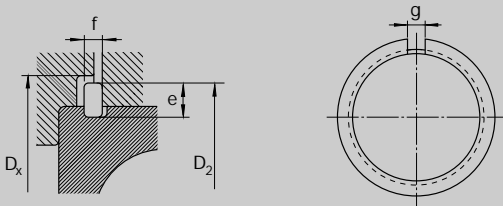

Unit : mm

Snap Ring Bearing Ref. No.	e		f		g ²⁾ ≈	D ₂ ²⁾		Bearing Seats
						D _x		
	min	max	min	max	min	max	min	
NR 1022	1.85	2.0	0.6	0.7	2	24.8	25.5	
NR 1024	1.85	2.0	0.6	0.7	2	26.8	27.5	
NR 1028	1.9	2.05	0.75	0.85	3	30.8	31.5	
NR 1030	1.9	2.05	0.75	0.85	3	32.8	33.5	
NR 1032	1.9	2.05	0.75	0.85	3	34.8	35.5	
NR 1034	1.9	2.05	0.75	0.85	3	36.8	37.5	
NR 1037	1.9	2.05	0.75	0.85	3	39.8	40.5	
NR 1039	1.9	2.05	0.75	0.85	3	41.8	42.5	
NR 1040	1.9	2.05	0.75	0.85	3	42.8	43.5	
NR 1042	1.9	2.05	0.75	0.85	3	44.8	45.5	
NR 1044	1.9	2.05	0.75	0.85	4	46.8	47.5	
NR 1045	1.9	2.05	0.75	0.85	4	47.8	48.5	
NR 1047	1.9	2.05	0.75	0.85	4	49.8	50.5	
NR 1052	1.9	2.05	0.75	0.85	4	54.8	55.5	
NR 1055	1.9	2.05	0.75	0.85	4	57.8	58.5	
NR 1058	1.9	2.05	0.75	0.85	4	60.8	61.5	
NR 1062	1.9	2.05	0.75	0.85	4	64.8	65.5	
NR 1065	1.9	2.05	0.75	0.85	4	67.8	68.5	
NR 1068	1.9	2.05	0.75	0.85	5	70.8	72	
NR 1072	1.9	2.05	0.75	0.85	5	74.8	76	
NR 1078	3.1	3.25	1.02	1.12	5	82.7	84	
NR 1080	3.1	3.25	1.02	1.12	5	84.4	86	
NR 1085	3.1	3.25	1.02	1.12	5	89.4	91	
NR 1090	3.1	3.25	1.02	1.12	5	94.4	96	
NR 1095	3.1	3.25	1.02	1.12	5	99.4	101	
NR 1100	3.1	3.25	1.02	1.12	5	104.4	106	
NR 1105	3.89	4.04	1.02	1.12	5	110.7	112	
NR 1110	3.89	4.04	1.02	1.12	5	115.7	117	
NR 1115	3.89	4.04	1.02	1.12	5	120.7	122	
NR 1120	3.89	4.04	1.02	1.12	7	125.7	127	
NR 1125	3.89	4.04	1.02	1.12	7	130.7	132	
NR 1130	3.89	4.04	1.02	1.12	7	135.7	137	
NR 1140	3.89	4.04	1.6	1.7	7	145.7	147	
NR 1145	3.89	4.04	1.6	1.7	7	150.7	152	
NR 1150	3.89	4.04	1.6	1.7	7	155.7	157	
NR 1165	4.7	4.85	1.6	1.7	7	171.5	173	
NR 1175	4.7	4.85	1.6	1.7	10	181.5	183	
NR 1180	4.7	4.85	1.6	1.7	10	186.5	188	
NR 1190	4.7	4.85	1.6	1.7	10	196.5	198	
NR 1200	4.7	4.85	1.6	1.7	10	206.5	207	

2) The dimensions of g and D₂ are used after mounting the snap ring. Snap rings should be free of radial movement, and tightly fit to the snap ring groove, and expand after mounting.

6. Boundary Dimensions and Designated Numbering System

Table 6-6 Dimensions of Snap Ring Groove and Snap Ring - Diameter Series 0, 2, 3, 4

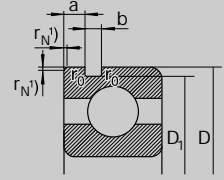

Bearings				Snap Ring Groove		Snap Ring				Snap Ring Groove		Snap Ring	
d				D	D ₁		a		b		r ₀		
Dimension Series 0	2	3	4		min	max	min	max	min	max	min	max	min
10	-	-	-	26	24.25	24.5	1.19	1.35	-	-	0.87	1.17	0.2
12	-	-	-	28	26.25	26.5	1.19	1.35	-	-	0.87	1.17	0.2
-	10	9	8	30	27.91	28.17	-	-	1.9	2.06	1.35	1.65	0.4
15	12	-	9	32	29.9	30.15	1.9	2.06	1.9	2.06	1.35	1.65	0.4
17	15	10	-	35	32.92	33.17	1.9	2.06	1.9	2.46	1.35	1.65	0.4
-	-	12	10	37	34.52	34.77	-	-	1.9	2.46	1.35	1.65	0.4
-	17	-	-	40	37.85	38.1	-	-	1.9	2.46	1.35	1.65	0.4
20	-	15	12	42	39.5	39.75	1.9	2.06	1.9	2.46	1.35	1.65	0.4
22	-	-	-	44	41.5	41.75	1.9	2.06	-	-	1.35	1.65	0.4
25	20	17	-	47	44.35	44.6	1.9	2.06	2.31	2.46	1.35	1.65	0.4
-	22	-	-	50	47.35	47.6	-	-	2.31	2.46	1.35	1.65	0.4
28	25	20	15	52	49.48	49.73	1.9	2.06	2.31	2.46	1.35	1.65	0.4
30	-	-	-	55	52.35	52.6	1.88	2.08	-	-	1.35	1.65	0.4
-	-	22	-	56	53.35	53.6	-	-	2.31	2.46	1.35	1.65	0.4
32	28	-	-	58	55.35	55.6	1.88	2.08	2.31	2.46	1.35	1.65	0.4
35	30	25	17	62	59.11	59.61	1.88	2.08	3.07	3.28	1.9	2.2	0.6
-	32	-	-	65	62.1	62.6	-	-	3.07	3.28	1.9	2.2	0.6
40	-	28	-	68	64.31	64.82	2.29	2.49	3.07	3.28	1.9	2.2	0.6
-	35	30	20	72	68.3	68.81	-	-	3.07	3.28	1.9	2.2	0.6
45	-	32	-	75	71.32	71.83	2.29	2.49	3.07	3.28	1.9	2.2	0.6
50	40	35	25	80	76.3	76.81	2.29	2.49	3.07	3.28	1.9	2.2	0.6
-	45	-	-	85	81.31	81.81	-	-	3.07	3.28	1.9	2.2	0.6
55	50	40	30	90	86.28	86.79	2.67	2.87	3.07	3.28	2.7	3	0.6
60	-	-	-	95	91.31	91.82	2.67	2.87	-	-	2.7	3	0.6
65	55	45	35	100	96.29	96.8	2.67	2.87	3.07	3.28	2.7	3	0.6
70	60	50	40	110	106.3	106.81	2.67	2.87	3.07	3.28	2.7	3	0.6
75	-	-	-	115	111.3	111.81	2.67	2.87	-	-	2.7	3	0.6
-	65	55	45	120	114.71	115.21	-	-	3.86	4.06	3.1	3.4	0.6
80	70	-	-	125	119.71	120.22	2.67	2.87	3.86	4.06	3.1	3.4	0.6
85	75	60	50	130	124.71	125.22	2.67	2.87	3.86	4.06	3.1	3.4	0.6
90	80	65	55	140	134.72	135.23	3.45	3.71	4.65	4.9	3.1	3.4	0.6
95	-	-	-	145	139.73	140.23	3.45	3.71	-	-	3.1	3.4	0.6
100	85	70	60	150	144.73	145.24	3.45	3.71	4.65	4.9	3.1	3.4	0.6
105	90	75	65	160	154.71	155.22	3.45	3.71	4.65	4.9	3.1	3.4	0.6
110	95	80	-	170	163.14	163.65	3.45	3.71	5.44	5.69	3.5	3.8	0.6
120	100	85	70	180	173.15	173.66	3.45	3.71	5.44	5.69	3.5	3.8	0.6
-	105	90	75	190	183.13	183.64	-	-	5.44	5.69	3.5	3.8	0.6
130	110	95	80	200	193.14	193.65	5.44	5.69	5.44	5.69	3.5	3.8	0.6

1) The min. permissible dimension of chamfer dimension r_N on the snap ring groove side of outer ring is 0.5mm. However, for the bearings with outer diameter smaller than 35mm among the ones of diameter series 0, it is

0.3mm.

2) The dimensions of g and D_2 are used after mounting the snap ring. Snap rings should be free of radial movement, and tightly fit to the snap ring groove, and expand after

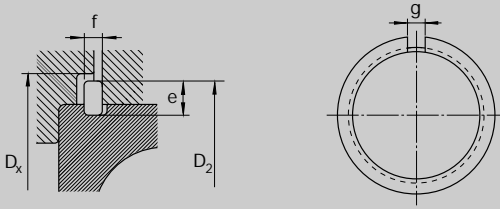

Unit : mm

Snap Ring Bearing Ref. No.	e		f		g ³⁾	D ₂ ³⁾	Bearing Seats D _x
	min	max	min	max	≈		min
					min	max	
NR 26 ³⁾	1.91	2.06	0.74	0.84	3	28.7	29.4
NR 28 ³⁾	1.91	2.06	0.74	0.84	3	30.7	31.4
NR 30	3.1	3.25	1.02	1.12	3	34.7	35.5
NR 32	3.1	3.25	1.02	1.12	3	36.7	37.5
NR 35	3.1	3.25	1.02	1.12	3	39.7	40.5
NR 37	3.1	3.25	1.02	1.12	3	41.3	42
NR 40	3.1	3.25	1.02	1.12	3	44.6	45.5
NR 42	3.1	3.25	1.02	1.12	3	46.3	47
NR 44	3.1	3.25	1.02	1.12	3	48.3	49
NR 47	3.89	4.04	1.02	1.12	4	52.7	53.5
NR 50	3.89	4.04	1.02	1.12	4	55.7	56.5
NR 52	3.89	4.04	1.02	1.12	4	57.9	58.5
NR 55	3.89	4.04	1.02	1.12	4	60.7	61.5
NR 56	3.89	4.04	1.02	1.12	4	61.7	62.5
NR 58	3.89	4.04	1.02	1.12	4	63.7	64.5
NR 62	3.89	4.04	1.6	1.7	4	67.7	68.5
NR 65	3.89	4.04	1.6	1.7	4	70.7	71.5
NR 68	4.7	4.85	1.6	1.7	5	74.6	76
NR 72	4.7	4.85	1.6	1.7	5	78.6	80
NR 75	4.7	4.85	1.6	1.7	5	81.6	83
NR 80	4.7	4.85	1.6	1.7	5	86.6	88
NR 85	4.7	4.85	1.6	1.7	5	91.6	93
NR 90	4.7	4.85	2.36	2.46	5	96.5	98
NR 95	4.7	4.85	2.36	2.46	5	101.6	103
NR 100	4.7	4.85	2.36	2.46	5	106.5	108
NR 110	4.7	4.85	2.36	2.46	5	116.6	118
NR 115	4.7	4.85	2.36	2.46	5	121.6	123
NR 120	7.06	7.21	2.72	2.82	7	129.7	131.5
NR 125	7.06	7.21	2.72	2.82	7	134.7	136.5
NR 130	7.06	7.21	2.72	2.82	7	139.7	141.5
NR 140	7.06	7.21	2.72	2.82	7	149.7	152
NR 145	7.06	7.21	2.72	2.82	7	154.7	157
NR 150	7.06	7.21	2.72	2.82	7	159.7	162
NR 160	7.06	7.21	2.72	2.82	7	169.7	172
NR 170	9.45	9.6	3	3.1	10	182.9	185
NR 180	9.45	9.6	3	3.1	10	192.9	195
NR 190	9.45	9.6	3	3.1	10	202.9	205
NR 200	9.45	9.6	3	3.1	10	212.9	215

mounting.

³⁾ Snap ring and its groove for these bearings are not specified in KS.

6. Boundary Dimensions and Designated Numbering System

6-3 Designated Numbering System

6-3-1 Purpose

The purpose of designating the numbers to the bearings is to prevent confusion during productions or when they are put to use, and also for the convenience of their systematic maintenance. By using the designated codes, boundary dimensions, such as bore or outer diameters, can be easily referenced, and the special characteristic shape of a bearing can be easily recognized just by identifying its prefix and suffix.

Boundary dimensions of bearings that are most frequently used are generally specified in accordance with the basic plan of boundary dimensions of ISO standards, and the designated numbers of standard bearings are specified in the KS B 2012- (Designated Numbering System for Rolling Bearings).

6-3-2 Composition

Designated numbers consist of two parts, a basic part and a auxiliary part as shown in Table 6-7.

Bearing series code in the basic part consists of code denoting the bearing type and the dimension series number, and the code denoting its type is represented by either a single digit number or a single alphabet letter. Also, the combination of both width series numbers and diameter series numbers

are called the dimension series numbers, and they are both represented by a single digit number.

However, in some instances it is customary to omit some of the width series numbers. Detailed illustration on dimension series numbers by each type are shown in Table 6-8.

Bore diameter reference numbers are usually denoted by two digit numbers.

The bearings with the bore diameter larger than 20mm are denoted by a number equal to 1/5 of bore diameter, and for the ones with bore diameter smaller than 10mm, they are denoted by single digit bore diameter, whereas, for the ones between 10mm and 17mm, they are denoted by the numbers from 00 to 03.

For the bearings whose bore diameters cannot be represented with a multiple of 5, the actual bore diameter should be written down after the “/” sign. Examples of these are shown in Table 6-9.

Contact angles for single row angular contact ball bearings and tapered roller bearings(Metric series) are shown in Table 6-10.

Auxiliary codes consist of prefix and suffix representing the detailed specifications, such as bearing's tolerances, clearance, and seal type, etc.

Table 6-7 Composition of Designated Numbers

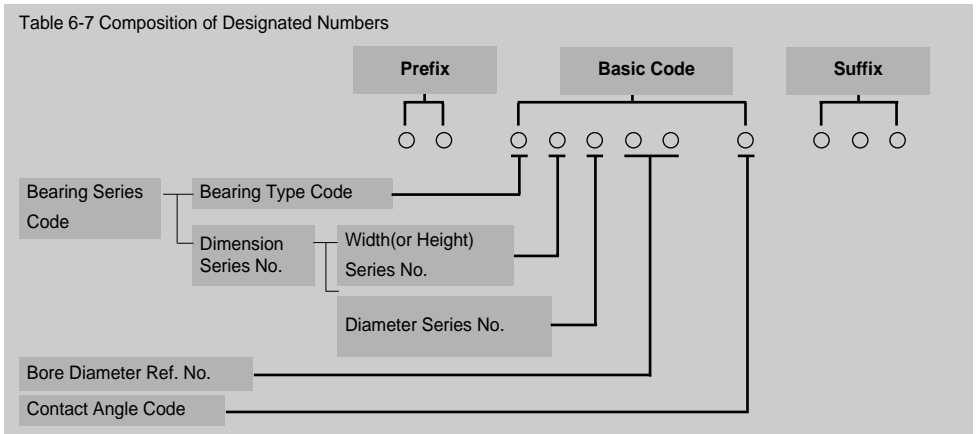

Table 6-8 Dimension Series Numbers

	Dimension Series Width Series No.	Height Series No.	Diameter Series No.
Radial Bearing (Except tapered roller bearings)	8, 0, 1, 2, 3, 4, 5, 6		7, 8, 9, 0, 1, 2, 3, 4
Tapered Roller Bearing	0, 1, 2, 3		9, 0, 1, 2, 3
Thrust Bearing		7, 9, 1, 2	0, 1, 2, 3, 4

Table 6-9 Bearing Bore Diameter Ref. No.

Bore Diameter Ref. No.	6	8	9	00	01	02	03	04	05	10	18	/22	/28	/32	/500
Bore Diameter(mm)	6	8	9	10	12	15	17	20	25	50	90	22	28	32	500

Table 6-10 Contact Angle Codes

Bearing Type	Nominal Contact Angle	Contact Angle Code
Single Row Angular Contact Ball Bearing	30°	A ¹⁾
	40°	B
	15°	C
	25°	E
Tapered Roller Bearings (Metric Series)	Up to approximately 17°	Not indicated
	17°~24°	C
	24°~32°	D

¹⁾ They are generally not indicated in the designated numbers.

In Table 6-14, the arrangements and typical basic and auxiliary codes for KBC bearings are shown. Some examples are shown below.

Example 1

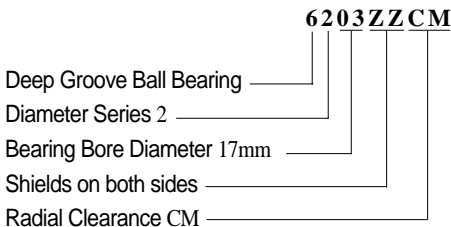

Example 2

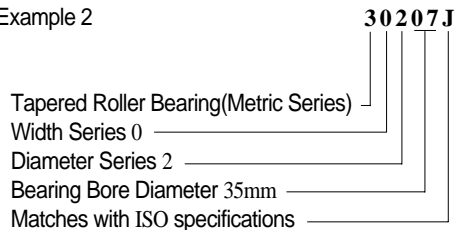

Example 3

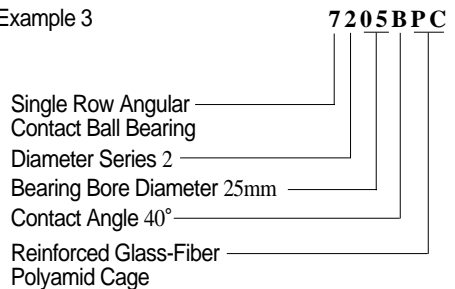

Example 4

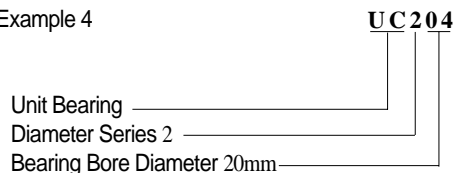

6. Boundary Dimensions and Designated Numbering System

6-3-3 Designated Numbering Systems for Inch Series Tapered Roller Bearings

The composition of designated numbering system for inch series tapered roller bearings are specified in the AFBMA Standards. The composition of designated numbers that are described here will be applied to the newly designed bearings, and for the ones already designated by using the old method, the same old code numbers will be used as is.

The loads are denoted from the lightest to the heaviest in the form of EL, LL, L, LM, M, HM, H, HH, EH, and T. However, T is used only for thrust bearings.

Contact angle No. is represented by a single digit number, and its designation method is shown in Table 6-12.

Series No. is represented by single to triple digit numbers, and the max. inner diameters for each Series No. are shown in Table 6-13.

Extra two digit numbers are placed in front of the auxiliary code, and these numbers are the specifically assigned numbers for the inner or outer rings of the bearing. The numbers from 10 to 19 are designated for outer rings, and the thinnest outer ring is assigned with the number 10 for all tapered roller bearings, regardless of their series. The numbers from 30 to 49 are designated for inner rings, and the thinnest inner ring is assigned with the number 49 for all tapered roller bearings,

regardless of their series. Auxiliary codes are associated with bearing's materials, heat treatments, and detailed design specifications, etc., and they are assigned to all the bearings produced by KBC.

Table 6-12 Contact Angle Numbers of Inch Series Tapered Roller Bearing

Outer Ring Angle(Contact Angle x 2)		No.
From	Under	
0°	24°	1
24°	25° 30'	2
25° 30'	27°	3
27°	28° 30'	4
28° 30'	30° 30'	5
30° 30'	32° 30'	6
32° 30'	36°	7
36°	45°	8
45° From		9 ¹⁾
90° Thrust Bearing		0

1) Except for thrust bearings.

Table 6-11 The Composition of Designated Numbers of Inch Series Tapered Roller Bearing

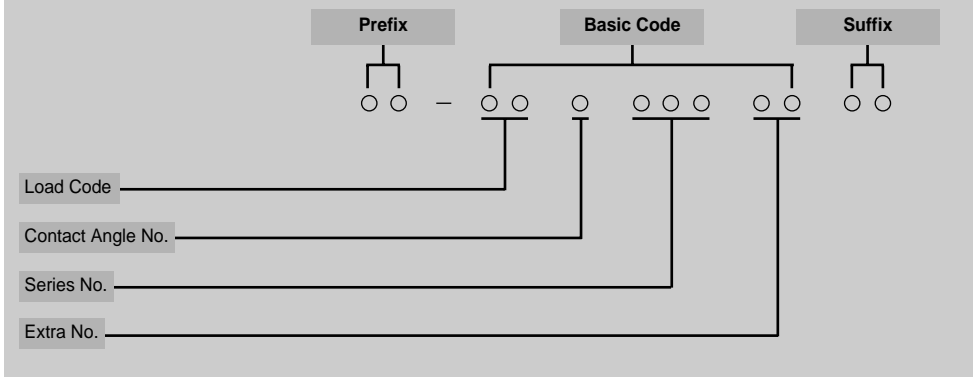
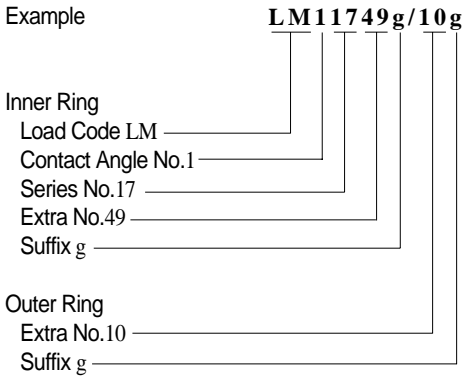

Table 6-13 Series Numbers of Inch Series Tapered Roller Bearing

Max. Bore Diameter(inch) Over	Up to	Series No.
0	1	0...19
1	2	20...99, 000...030
2	3	030...129
3	4	130...189
4		190...999

Refer to the Example shown below for the designation system of inch series tapered roller bearings.



6. Boundary Dimensions and Designated Numbering System

Table 6-14 Basic and Auxiliary codes of KBC Bearings

Prefix	Basic Code					Suffix						
	Bearing Series No.			Bore Diameter Ref. No.		Contact Angle Code		Bore Design Code		Material Code		
	Type Code	Dimension Series No.		Code	Content	Code	Content	Code	Content	Code	Content	
	Width/Height Series	Inner Diameter Series										
BR	Non-Standard Deep Groove Ball Bearing	6	(1)	9	8	8mm	Angular Contact Ball Bearing	A	Bearing of which inner design is different from the standards	g	Case Hardened Steel	
		6	(1)	0	:							
TR	Non-standard Tapered Roller Bearing	6	(0)	2	01	10mm	A	30°	J	Tapered roller bearing bearing produced in accordance with ISO.	HL	heat Treatment For Long Life
		6	(0)	3	02	12mm	B	40°				
EC	Non-creep Bearing	7	(1)	0	03	15mm	C	15°	Tapered Roller Bearing			
		7	(0)	2	:							
HC	Bearing Of High Load Carrying Capacity	7	(0)	3	04	17mm	E	25°	Up to 17°			
					:							
SM	Angular Contact Ball Bearing For High Speed	3	2	0	05	20mm			Approx 20°			
		3	0	2	:							
SA	Single Row Angular Contact Ball Bearing Special Dimension	3	2	3	/22	22mm	C	Approx 20°	Approx 28°			
		3	0	3	:							
SDA	Double Row Angular Contact Ball Bearing of Special Dimension	3	2	3	/28	28mm	D	Approx 28°				
		3	2	3	:							
DT	Double Row Tapered Roller Bearing	3	2	0	18	90mm						
CB	Ceramic Bearing	3	0	2								
HB	Ceramic Bearing for high speed	3	2	2								
SA	Bearing for special environment	3	0	3								
		5	1	1								
		UC	(0)	2								
		UB	(0)	2								

Suffix

Cage Code	Sealing Code	Inner/outer Ring shape Code	Arrangement Code	Internal Clearance or Preload Code	Tolerance Class Code	Grease Code	
Code Content	Code Content	Code Content	Code Content	Code Content	Code Content	Code Content	
PC Reinforced Glass-Fiber Polyamid Cage	Z One Side Shield	N Snap Ring Groove of the outer ring	DF Face to face Arrangement	Deep Groove Ball Gearing	KS General Class	G1	
	ZZ Two Side Shield						C2 Smaller Than Normal Clearance
SL Tufftridied and pressed Steel Cage	U Noncontact Seal on one side	NR Snap ring mounted on snap ring groove of outer ring	DB Back to back Arrangement	Normal Clearance	P5 KS Class 5	G3	
	UU Noncontact Seal on two sides						NCX Eccentric Snap ring Groove
PH Phenol Resin Cage	D Contact Seal on one side	F1 Bore diameter different from the standards		C3 Larger than Normal Clearance	P4 KS Class 4	G101	
							DD Contact Seal on two sides
		h Width Dimensions different from the standards			C5 Larger than Class 4	HW KBC Special Class	
					CM Clearance for Motor		
					Small Diameter bearing		
					MC1 Smaller than MC2 Clearance		
					MC2 Smaller than MC3 Clearance		
					MC3 Normal Clearance		
					MC4 Lager than MC3 Clearance		
					MC5 Lager than MC4 Clearance		
				Combination Angular Contant Ball Bearing			
				/GL Light Preload			
				/GM Medium Preload			
				/GH Heavy Preload			

7. Dimensional and Running Accuracy of Bearings

7. Dimensional and Running Accuracy of Bearings

7-1 Specification of Tolerance Classes

Bearing is an important component mounted in the different parts of various machines, and its dimensional and running accuracies are the element of much importance in its production and usage.

The specifications of bearing's dimensional and running accuracies are contained in KS B 2014, and its measuring method in KS B 2015. And bearing's dimensional accuracies, which are of importance when mounted on a shaft or housing, relate to all tolerances of boundary dimensions, chamfer dimensions, and width variations, etc., and its running accuracies, which need to be considered when controlling the rotating elements, relates to all tolerances of radial runout, axial runout, side face runout, and inclination of outer diameter surface, etc.

Tolerances have been classified into KS Class 0(Normal tolerance class), and Class 6, Class 5, Class 4, and Class 2, increasing in the order of

tighter tolerances, and these tolerances comply with the specifications of ISO. In addition to these Classes, there is another Class HW in between Classes 4 and 2, which has been specified and used just by KBC.

Classes of bearing tolerances for each type in accordance with KS Tolerance Classes as well as those of ISO and other industrial countries, are listed in Table 7-1.

7-2 Definition of Dimensional and Running Accuracy

Dimensional and running accuracies for bearings are designated as below, and their values are shown in Table 7-2 to 7-6.

7-2-1 Dimensional Accuracy

(1) Inner Ring

d Nominal bore diameter

d_s Single bore diameter

d_{mp} Single plane mean bore diameter; The arithmetical mean of the largest and the smallest single bore diameters measured in one radial plane.

Table 7-1 Bearing Types and Tolerance Classes

Bearing Type		Tolerance Class				
Radial Bearings(Except tapered roller bearings)		KS 0 Class	KS 6 Class	KS 5 Class	KS 4 Class	KS 2 Class
Tapered Roller Bearing	Metric Series		KS 0 Class	KS 6 Class	KS 5 Class	KS 4 Class
	Inch Series	AFBMA 4 Class	AFBMA 2 Class	AFBMA 3 Class	AFBMA 0 Class	
Thrust Ball Bearing		KS 0 Class	KS 6 Class	KS 5 Class	KS 4 Class	
Equivalent Classes of Other Countries	ISO	ISO Normal Class	ISO 6 Class	ISO 5 Class	ISO 4 Class	ISO 2 Class
	DIN	0 Class	6 Class	5 Class	4 Class	2 Class
	JIS	0 Class	6 Class	5 Class	4 Class	2 Class
AFBMA	Ball Bearing	ABEC 1	ABEC 3	ABEC 5	ABEC 7	ABEC 9
	Roller Bearing	RBEC 1	RBEC 3	RBEC 5		

Note :

ISO : International Organization for standardization

DIN : German Standards

JIS : Japanese Industrial Standards

AFBMA : Anti-Friction Bearing Manufacturers Association Standards in U.S.A.

$\Delta_{dmp} = d_{mp} - d$
 Single plane mean bore diameter deviation; The difference between a single plane mean bore diameter and the nominal bore diameter of a basically cylindrical bore.

$\Delta_{dmp} = d_{mp} - d$
 Deviation of a single bore diameter; The difference between a single bore diameter and the nominal bore diameter of a basically cylindrical bore.

V_{dp} Bore diameter variation in a single radial plane; The difference between the largest and the smallest of the single bore diameters in a single radial plane.

$V_{dmp} = d_{mpmax} - d_{mpmin}$
 Mean bore diameter variation; The difference between the largest and the smallest of the single plane mean bore diameters of cylindrical bore.

(2) Outer Ring

D Nominal outside diameter

D_s Single outside diameter

D_{mp} Single plane mean outside diameter; The arithmetical mean of the largest and the smallest of the single outside diameters in one single radial plane.

$\Delta_{Dmp} = D_{mp} - D$
 Single plane mean outside diameter deviation; The difference between a single plane mean outside diameter and the nominal outside diameter of a basically cylindrical outside surface.

$\Delta_{D_s} = D_s - D$
 Deviation of a single outside diameter; The difference between a single outside diameter and the nominal outside diameter of a basically cylindrical outside surface.

V_{Dp} Outside diameter variation in a single radial plane; Difference between the largest and the smallest of the single outside diameters in a single radial plane.

$V_{Dmp} = D_{mpmax} - D_{mpmin}$
 Mean outside diameter variation; The difference between the largest and the smallest of the mean outside diameters.

(3) Width and Height

B, C Nominal ring widths

B_s, C_s Single ring widths

$\Delta_{B_s} = B_s - B, \Delta_{C_s} = C_s - C$
 Deviation of a single ring width; The difference between a single ring width and the nominal ring width.

$V_{B_s} = B_{smax} - B_{smin}, V_{C_s} = C_{smax} - C_{smin}$
 Ring width variation; The difference between the largest and the smallest of the single ring width of an individual ring.

T Nominal bearing width

T_s Actual bearing width(Tapered roller bearing); The distance between the points of intersection of the bearing axis and the two planes tangential to the actual ring faces designated to bound the width of a radial bearing ring where one inner ring face and one outer ring face are designated to bound the width.

T_{1s} Single overall width of inner ring(Tapered roller bearing); Single overall width of a tapered roller bearing with cone and master cup.

T_{2s} Single overall width of outer ring(Tapered roller bearing); Single overall width of a tapered roller bearing with master cone and cup.

$\Delta_{T_s} = T_s - T, \Delta_{T_{1s}} = T_{1s} - T_1, \Delta_{T_{2s}} = T_{2s} - T_2$
 Deviation of a single overall width of a tapered roller bearing from nominal dimensions. Deviations of a single overall width of a tapered roller bearing, single overall width of inner ring with cone and master cup, and single overall width of outer ring with master cone and cup, from each of

7. Dimensional and Running Accuracy of Bearings

nominal single overall width, nominal single overall width with cone and master cup, and nominal single overall width with master cone and cup, respectively.

H Nominal height

H_s Single overall height ; Single overall height of thrust bearing

$\Delta_{H_s} = H_s - H$

Deviation in height ; Deviation of single overall height of thrust bearing from its nominal height.

S_D Inclination variation of outside cylindrical surface; The largest value in total variation of outside cylindrical surface to any two points on both side surfaces of outer ring(They should be distanced by more than 1.2 times of chamfer dimension.)

S_i Shaft washer thickness variation(Thrust bearing); Difference between the largest and smallest distances from raceway middle to back face.

S_e Housing washer thickness variation(Thrust bearing); Difference between the largest and smallest distances from raceway middle to back face.

7-2-2 Running Accuracy

$K_{ra}(K_{ra})$ Radial runout of assemble bearing inner ring ; When radial bearing outer(inner) ring is fixed and inner(outer) ring is floating, the difference between the largest and smallest radial distances of locating outer(inner) ring is called as the radial runout of bearing inner(outer) ring, provided that raceway is in contact with the rolling element at the radial location of above mentioned point.

$S_{ra}(S_{ra})$ Axial runout ; To measure the axial runout, the outer(inner) ring has to be fixed perpendicular to the bearing central shaft, and then a measured load needs to be applied in the same direction as the central shaft of inner(outer) ring, and then a measuring instrument on the standard side of inner(outer) ring is placed, and then the inner(outer) ring is rotated for one full revolution. Then, the difference between the largest and smallest values shown on the scale is called as the axial runout.

S_d Side face runout of inner ring with reference to bore ; The difference between the largest and smallest axial distances from the side face to the plane perpendicular to the central shaft from the distance of a radius of mean raceway radius of inner ring in the direction from the inner ring's central shaft to the circumference, is called as the side face runout.

7. Dimensional and Running Accuracy of Bearings

Table 7-2 Tolerances of Radial Bearing(Except Tapered Roller Bearings)

Inner Ring

Dimension(unit : mm)

Nominal Bore Diameter	Over Up to	0.6 ¹⁾ 2.5	2.5 10	10 18	18 30	30 50	50 80	80 120	120 150	150 180	180 250	250 315	315 400	400 500	500 630	630 800	800 1000	1000 1250
-----------------------	------------	--------------------------	-----------	----------	----------	----------	----------	-----------	------------	------------	------------	------------	------------	------------	------------	------------	-------------	--------------

Tolerance Class 0(Normal Tolerance)

Tolerance (unit : μm)

Bore, Cylindrical Deviation	$\Delta_{dmp}^{3)}$	0 -8	0 -8	0 -8	0 -10	0 -12	0 -15	0 -20	0 -25	0 -25	0 -30	0 -35	0 -40	0 -45	0 -50	0 -75	0 -100	0 -125
Variation V_{dp}	Diameter Series 9	10	10	10	13	15	19	25	31	31	38	44	50	56	63			
	0 · 1	8	8	8	10	12	19	25	31	31	38	44	50	56	63			
	2 · 3 · 4	6	6	6	8	9	11	15	19	19	23	26	30	34	38			
Variation	V_{dmp}	6	6	6	8	9	11	15	19	19	23	26	30	34	38			
Width Deviation	$\Delta_{Bs}^{4)}$	0 -40	0 -120	0 -120	0 -120	0 -120	0 -150	0 -200	0 -250	0 -250	0 -300	0 -350	0 -400	0 -450	0 -500	0 -750	0 -1000	0 -1250
Width Variation	V_{Bs}	12	15	20	20	20	25	25	30	30	30	35	40	50	60	70	80	100
Radial Runout	K_{Ia}	10	10	10	13	15	20	25	30	30	40	50	60	65	70	80	90	100

Tolerance Class P6

Deviation	$\Delta_{dmp}^{3)}$	0 -7	0 -7	0 -7	0 -8	0 -10	0 -12	0 -15	0 -18	0 -18	0 -22	0 -25	0 -30	0 -35	0 -40			
Variation V_{dp}	Diameter Series 9	9	9	9	10	13	15	19	23	23	28	31	38	44	50			
	0 · 1	7	7	7	8	10	15	19	23	23	28	31	38	44	50			
	2 · 3 · 4	5	5	5	6	8	9	11	14	14	17	19	23	26	30			
Variation	V_{dmp}	5	5	5	6	8	9	11	14	14	17	19	23	26	30			
Width Deviation	$\Delta_{Bs}^{4)}$	0 -40	0 -120	0 -120	0 -120	0 -120	0 -150	0 -200	0 -250	0 -300	0 -300	0 -350	0 -400	0 -450	0 -500			
Width Variation	V_{Bs}	12	15	20	20	20	25	25	30	30	30	35	40	45	50			
Radial Runout	K_{Ia}	5	6	7	8	10	10	13	18	18	20	25	30	35	40			

Note The larger Δ_{dmp} and the smaller Δ_{dmp} in the table do not apply when the width of raceway face is within 1.2 times the maximum fillet radius.

Annotations¹⁾ Includes 0.6mm

²⁾ Includes 2.5mm

³⁾ Applies only to cylindrical inner diameter bearings

⁴⁾ Contact KBC for Δ_{Bs} and Δ_{Cs} of arranged bearings

Outer Ring

Dimension(unit:mm)

Nominal Outside Diameter	Over Up to	2.5 ²) 6	6	18	30	50	80	120	150	180	250	315	400	500	630	800	1000	1250	1600	2000
-----------------------------	---------------	-------------------------	---	----	----	----	----	-----	-----	-----	-----	-----	-----	-----	-----	-----	------	------	------	------

Tolerance Class 0(Normal Tolerance)

Tolerance(unit : μm)

Deviation	Δ_{Dmp}	0 -8	0 -8	0 -9	0 -11	0 -13	0 -15	0 -18	0 -25	0 -30	0 -35	0 -40	0 -45	0 -50	0 -75	0 -100	0 -125	0 -160	0 -200
Variation V_{Dp}	Diameter Series 9	10	10	12	14	16	19	23	31	38	44	50	56	63	94	125			
	0 · 1	8	8	9	11	13	19	23	31	38	44	50	56	63	94	125			
	2 · 3 · 4	6	6	7	8	10	11	14	19	23	26	30	34	38	55	75			
	Sealed Type Bearing 2 · 3 · 4 10	10	12	16	20	26	30	38											
Variation	V_{Dmp}	6	6	7	8	10	11	14	19	23	26	30	34	38	55	75			
Radial Runout	K_{ea}	15	15	15	20	25	35	40	45	50	60	70	80	100	120	140	160	190	220

The width tolerances Δ_{Cs} and V_{Cs} are same as Δ_{Bs} and V_{Bs} of inner ring, respectively.

Tolerance Class P6

Deviation	Δ_{Dmp}	0 -7	0 -7	0 -8	0 -9	0 -11	0 -13	0 -15	0 -18	0 -20	0 -25	0 -28	0 -33	0 -38	0 -45	0 -60			
Variation V_{Dp}	Diameter Series 9	9	9	10	11	14	16	19	23	25	31	35	41	48	56	75			
	0 · 1	7	7	8	9	11	16	19	23	25	31	35	41	48	56	75			
	2 · 3 · 4	5	5	6	7	8	10	11	14	15	19	21	25	29	34	45			
	Sealed Type Bearing 0 · 1 · 2 · 3 · 4	9	9	10	13	16	20	25	30										
Variation	V_{Dmp}	5	5	6	7	8	10	11	14	15	19	21	25	29	34	45			
Radial Runout	K_{ea}	8	8	9	10	13	18	20	23	25	30	35	40	50	60	75			

The width tolerances Δ_{Cs} and V_{Cs} are same as Δ_{Bs} and V_{Bs} of inner ring, respectively.

7. Dimensional and Running Accuracy of Bearings

Inner Ring

Dimension(unit : mm)

Nominal Bore Diameter	Over Up to	0.6 ¹⁾ 2.5	2.5 10	10 18	18 30	30 50	50 80	80 120	120 150	150 180	180 250	250 315	315 400
-----------------------	------------	--------------------------	-----------	----------	----------	----------	----------	-----------	------------	------------	------------	------------	------------

Tolerance Class P5

Tolerance(unit: μm)

Deviation	$\Delta_{dmp}^{3)}$	0 -5	0 -5	0 -5	0 -6	0 -8	0 -9	0 -10	0 -13	0 -13	0 -15	0 -18	0 -23
Variation V_{dp}	Diameter Series 9	5	5	5	6	8	9	10	13	13	15	18	23
	0-1-2-3-4	4	4	4	5	6	7	8	10	10	12	14	18
Variation	V_{dmp}	3	3	3	3	4	5	5	7	7	8	9	12
Width Dimension Deviation	$\Delta_{Bs}^{5)}$	0 -40	0 -40	0 -80	0 -120	0 -120	0 -150	0 -200	0 -250	0 -250	0 -300	0 -350	0 -400
Width Variation	V_{Bs}	5	5	5	5	5	6	7	8	8	10	13	15
Radial Runout	K_{ia}	4	4	4	4	5	5	6	8	8	10	13	15
Side face Runout	S_d	7	7	7	8	8	8	9	10	10	11	13	15
Axial Runout	$S_{ia}^{6)}$	7	7	7	8	8	8	9	10	10	13	15	20

Tolerance Class P4

Deviation	$\Delta_{dmp}^{3)}$, $\Delta_{ds}^{4)}$	0 -4	0 -4	0 -4	0 -5	0 -6	0 -7	0 -8	0 -10	0 -10	0 -12		
Variation V_{dp}	Diameter Deviation 9	4	4	4	5	6	7	8	10	10	12		
	0-1-2-3-4	3	3	3	4	5	5	6	8	8	9		
Variation	V_{dmp}	2	2	2	2.5	3	3.5	4	5	5	6		
Width Variation	$\Delta_{Bs}^{5)}$ -40	0 -40	0 -80	0 -120	0 -120	0 -150	0 -200	0 -250	0 -250	0 -300	0		
Width Variation	V_{Bs}	2.5	2.5	2.5	2.5	3	4	4	5	5	6		
Radial Runout	K_{ia}	2.5	2.5	2.5	3	4	4	5	6	8	8		
Side face Runout	S_d	3	3	3	4	4	5	5	6	6	7		
Axial Runout	$S_{ia}^{6)}$	3	3	3	4	4	5	5	7	7	8		

Note The larger Δ_{dmp} and the smaller Δ_{dmp} in the table do not apply when the width of raceway face is within 1.2 times the maximum fillet radius.

Annotations¹⁾ Includes 0.6mm

²⁾ Includes 2.5mm

³⁾ applies only to cylindrical inner diameter bearings.

⁴⁾ these values of Δ_{ds} and Δ_{Ds} apply only to diameter series 0, 1, 2, 3, 4 and 4

⁵⁾ Contact KBC for Δ_{Bs} and Δ_{Cs} of arranged bearings

⁶⁾ Axial runout, S_{ia} applies to ball bearings (Except self-aligning ball bearings)

Outer Ring

Dimension (Unit : mm)

Nominal Outer Ring	Over Up to	2.5 ²⁾ 6	6 18	18 30	30 50	50 80	80 120	120 150	150 180	180 250	250 315	315 400	400 500	500 630	630 800
-----------------------	---------------	------------------------	---------	----------	----------	----------	-----------	------------	------------	------------	------------	------------	------------	------------	------------

Tolerance Class P5

Tolerance(Unit : μm)

Deviation	V_{Dmp}	0 -5	0 -5	0 -6	0 -7	0 -9	0 -10	0 -11	0 -13	0 -15	0 -18	0 -20	0 -23	0 -28	0 -35
Variation V_{Dp}	Diameter Series 9	5	5	6	7	9	10	11	13	15	18	20	23	28	35
	0 · 1 · 2 · 3 · 4	4	4	5	5	7	8	8	10	11	14	15	17	21	26
Variation	V_{Dmp}	3	3	3	4	5	5	6	7	8	9	10	12	14	18
Width Variation	V_{Cs}	5	5	5	5	6	8	8	8	10	11	13	15	18	20
Radial Runout	K_{ea}	5	5	6	7	8	10	11	13	15	18	20	23	25	30
Inclination	S_D	8	8	8	8	8	9	10	10	11	13	13	15	18	20
Axial Runout	$S_{ea}^{6)}$	8	8	8	8	10	11	13	14	15	18	20	23	25	30

The width tolerances Δ_{Cs} and V_{Cs} are same as Δ_{Bs} and V_{Bs} of inner ring, respectively.

Tolerance Class P4

Dimension	Δ_{Dmp}	0 -4	0 -4	0 -4	0 -6	0 -7	0 -8	0 -9	0 -10	0 -11	0 -13	0 -15			
Dimension	$\Delta_{Ds}^{4)}$	0 -4	0 -4	0 -5	0 -6	0 -7	0 -8	0 -9	0 -10	0 -11	0 -13	0 -15			
Variation V_{Dp}	Diameter Series 9	4	4	5	6	7	8	9	10	11	13	15			
	0 · 1 · 2 · 3 · 4	3	3	4	5	5	6	7	8	8	10	11			
Variation	V_{Dmp}	2	2	2.5	3	3.5	4	5	5	6	7	8			
Width Deviation	V_{Cs}	2.5	2.5	2.5	2.5	3	4	5	5	7	7	8			
Radial Runout	K_{ea}	3	3	4	5	5	6	7	8	10	11	13			
Inclination	S_D	4	4	4	4	4	5	5	5	7	8	10			
Axial Runout	$S_{ea}^{6)}$	5	5	5	5	5	6	7	8	10	10	13			

The width tolerances Δ_{Cs} and V_{Cs} are same as Δ_{Bs} and V_{Bs} of inner ring, respectively.

7. Dimensional and Running Accuracy of Bearings

Inner Ring

Dimension (Unit : mm)

Nominal Bore Diameter	Over Up to	0.6 ¹⁾ 2.5	2.5 10	10 18	18 30	30 50	50 80	80 120	120 150	150 180	180 250
-----------------------	------------	--------------------------	-----------	----------	----------	----------	----------	-----------	------------	------------	------------

Tolerance Class HW

Tolerance (unit : μm)

Deviation	$\Delta_{dmp}^{3)}, \Delta_{ds}^{4)}$	0 -4	0 -4	0 -4	0 -4	0 -5					
Variation V_{dp}	Diameter Series 0-1-2-3-4	4	4	4	4	5					
Variation	V_{dmp}	2	2	2	2	2.5					
Width Deviation	$\Delta_{Bs}^{5)}$	0 -40	0 -80	0 -120	0 -120	0 -125					
Width Variation	V_{Bs}	2	2	2	2	2					
Radial Runout	K_{ia}	2	2	2.5	2.5	2.5					
Side Face Runout	S_d	2	2	2	2	2					
Axial Runout	$S_{ia}^{6)}$	2	2	2.5	2.5	2.5					

Tolerance Class P2

Deviation	$\Delta_{dmp}^{3)}, \Delta_{ds}^{4)}$	0 -2.5	0 -2.5	0 -2.5	0 -2.5	0 -2.5	0 -4	0 -5	0 -7	0 -7	0 -8
Variation V_{dp}	Diameter Series 0-1-2-3-4	2.5	2.5	2.5	2.5	2.5	4	5	7	7	8
Variation	V_{dmp}	1.5	1.5	1.5	1.5	1.5	2	2.5	3.5	3.5	4
Width Deviation	$\Delta_{Bs}^{5)}$ -40	0 -40	0 -80	0 -120	0 -120	0 -150	0 -200	0 -250	0 -250	0 -300	0
Width Variation	V_{Bs}	1.5	1.5	1.5	1.5	1.5	1.5	2.5	2.5	4	5
Radial Runout	K_{ia}	1.5	1.5	1.5	2.5	2.5	2.5	2.5	2.5	5	5
Side Face Runout	S_d	1.5	1.5	1.5	1.5	1.5	1.5	2.5	2.5	4	5
Axial Runout	$S_{ia}^{6)}$	1.5	1.5	1.5	2.5	2.5	2.5	2.5	2.5	5	5

Note The larger Δ_{dmp} and the smaller Δ_{dmp} in the table do not apply when the width of raceway face is within 1.2 times the maximum fillet radius.

Annotations ¹⁾ Includes 0.6mm

²⁾ Includes 2.5mm

³⁾ applies only to cylindrical inner diameter bearings.

⁴⁾ these values of Δ_{ds} and Δ_{ds} apply only to diameter series 0, 1, 2, 3, 4 and 4

⁵⁾ Contact KBC for Δ_{Bs} and Δ_{Cs} of arranged bearings

⁶⁾ Axial runout, S_{ia} applies to ball bearings (Except self-aligning ball bearings)

Outer Ring

Dimension(Unit : mm)

Nominal Outside Diameter	Over Up to	2.5 ²⁾ 6	6 18	18 30	30 50	50 80	80 120	120 150	150 180	180 250	250 315	315 400
--------------------------	------------	------------------------	---------	----------	----------	----------	-----------	------------	------------	------------	------------	------------

Tolerance Class HW

Tolerance(Unit : μm)

Deviation	$\Delta_{D_{mp}}, \Delta_{D_S}^{6)}$			0 -4	0 -4	0 -4	0 -5	0 -5				
Variation V_{Dp}	Diameter Series 0 · 1 · 2 · 3 · 4			4	4	4	5	5				
Variation V_{Dmp}				2	2	2	2.5	2.5				
Width Variation	V_{C_S}			2	2	2	2.5	2.5				
Radial Runout	K_{ea}			2.5	2.5	4	5	5				
Inclination	S_D			2	2	2	2.5	2.5				
Axial Runout	$S_{ea}^{6)}$			2.5	2.5	4	5	5				

The width tolerances Δ_{C_S} and V_{C_S} are same as Δ_{B_S} and V_{B_S} of inner ring, respectively.

Tolerance Class P2

Deviation	$\Delta_{D_{mp}}, \Delta_{D_S}^{6)}$	0 -2.5	0 -2.5	0 -4	0 -4	0 -4	0 -5	0 -5	0 -7	0 -8	0 -8	0 -10
Variation V_{Dp}	Diameter Series 0 · 1 · 2 · 3 · 4	2.5	2.5	4	4	4	5	5	7	8	8	10
Variation V_{Dmp}		1.5	1.5	2	2	2	2.5	2.5	3.5	4	4	5
Width Variation	V_{C_S}	1.5	1.5	2.5	2.5	4	5	5	5	7	7	8
Radial Runout	K_{ea}	1.5	1.5	1.5	1.5	1.5	2.5	2.5	2.5	4	5	7
Inclination	S_D	1.5	1.5	2.5	2.5	4	5	5	5	7	7	8
Axial Runout	$S_{ea}^{6)}$	1.5	1.5	1.5	1.5	1.5	2.5	2.5	2.5	4	5	7

The width tolerances Δ_{C_S} and V_{C_S} are same as Δ_{B_S} and V_{B_S} of inner ring, respectively.

7. Dimensional and Running Accuracy of Bearings

Table 7-3 Tolerances of Metric Series Tapered Roller Bearing

Inner Ring

Dimension(Unit : mm)

Nominal Bore Diameter	Over up to	10	18	30	50	80	120	180	250	315	400	500	630
		18	30	50	80	120	180	250	315	400	500	630	800

Tolerance Class 0(Normal Tolerance)

Tolerance(Unit : μm)

Deviation	Δ_{dmp}	0 -8	0 -10	0 -12	0 -15	0 -20	0 -25	0 -30	0 -35	0 -40	0 -45	0 -50	0 -75
Variation	V_{dp}	8	10	12	15	20	25	30	35	40			
	V_{dmp}	6	8	9	11	15	19	23	26	30			
Width Deviation	Δ_{Bs}	0 -120	0 -120	0 -120	0 -150	0 -200	0 -250	0 -300	0 -350	0 -400	0 -450	0 -500	0 -750
Radial Runout	K_{ia}	15	18	20	25	30	35	50	60	70	70	85	100
Width Deviation	Δ_{Ts}	+200 0	+200 0	+200 0	+200 0	+200 -200	+500 -250	+350 -250	+350 -250	+400 -400	+400 -400	+400 -500	+600 -600
	Δ_{T1s}	+100 0	+100 0	+100 0	+100 0	+100 -100	+150 -150	+150 -150	+150 -150	+200 -200			
	Δ_{T2s}	+100 0	+100 0	+100 0	+100 0	+100 -100	+200 -100	+200 -100	+200 -100	+200 -200			

Tolerance Class P6X

Deviation	Δ_{dmp}	0 -8	0 -10	0 -12	0 -15	0 -20	0 -25	0 -30	0 -35	0 -40	0 -45	0 -50	0 -75
Variation	V_{dp}	8	10	12	15	20	25	30	35	40			
	V_{dmp}	6	8	9	11	15	19	23	26	30			
Width Deviation	Δ_{Bs}	0 -50	0 -50	0 -50	0 -50	0 -50	0 -50	0 -50	0 -50	0 -50			
Radial Runout	K_{ia}	15	18	20	25	30	35	50	60	70	70	85	100
Width Deviation	Δ_{Ts}	+100 0	+100 0	+100 0	+100 0	+100 0	+150 0	+150 0	+200 0	+200 0			
	Δ_{T1s}	+50 0	+50 0	+50 0	+50 0	+50 0	+50 0	+50 0	+100 0	+100 0			
	Δ_{T2s}	+50 0	+50 0	+50 0	+50 0	+50 0	+100 0	+100 0	+100 0	+100 0			

Note : 1) The larger Δ_{dmp} and the smaller Δ_{dmp} in the table do not apply when the width of raceway face is within 1.2 times the maximum fillet radius.

2) A part of this Table complies with the specifications of KBC.

Outer Ring

Dimension (Unit : mm)

Nominal Diameter	Outside Diameter	Over Up to	18 30	30 50	50 80	80 120	120 150	150 180	180 250	250 315	315 400	400 500	500 630	630 800	800 1000
------------------	------------------	------------	----------	----------	----------	-----------	------------	------------	------------	------------	------------	------------	------------	------------	-------------

Tolerance Class 0(Normal Tolerance)

Tolerance (Unit : μm)

Deviation	Δ_{Dmp}	0 -9	0 -11	0 -13	0 -15	0 -18	0 -25	0 -30	0 -35	0 -40	0 -45	0 -50	0 -75	0 -100
Variation	V_{Dp}	9	11	13	15	18	25	30	35	40	45	50		
	V_{Dmp}	7	8	10	11	14	19	23	26	30	34	38		
Width Deviation	Δ_{Cs}	The width tolerances Δ_{Cs} are same as Δ_{Bs} of inner ring, respectively.												
Radial Runout	K_{ea}	18	20	25	35	40	45	50	60	70	80	100	120	120

Tolerance Class P6X

Deviation	Δ_{Dmp}	0 -9	0 -11	0 -13	0 -15	0 -18	0 -25	0 -30	0 -35	0 -40	0 -45	0 -50	0 -75	0 -100
Variation	V_{Dp}	9	11	13	15	18	25	30	35	40	45	50		
	V_{Dmp}	7	8	10	11	14	19	23	26	30	34	38		
Width Deviation	Δ_{Cs}	0 -100	0 -100	0 -100	0 -100	0 -100	0 -100	0 -100	0 -100	0 -100				
Radial Runout	K_{ea}	18	20	25	35	40	45	50	60	70	80	100	120	120

7. Dimensional and Running Accuracy of Bearings

Inner Ring

Dimension (Unit : mm)

Nominal Bore Diameter	Over Up to	10	18	30	50	80	120	180	250	315	400	500	630	630
		18	30	50	80	120	180	250	315	400	500	630	800	

Tolerance Class P6

Tolerance (Unit : μm)

Deviation	Δ_{dmp}	0 -7	0 -8	0 -10	0 -12	0 -15	0 -18	0 -22	0 -25	0 -30	0 -35	0 -40	0 -60
Variation	V_{dp}	7	8	10	12	15	18	22					
	V_{dmp}	5	6	8	9	11	14	16					
Width Variation	Δ_{Bs}	0 -120	0 -120	0 -120	0 -150	0 -200	0 -250	0 -300	0 -350	0 -400			
Radial Runout	K_{ia}	7	8	10	10	13	18	20	25	30	35	40	45
Width Deviation	Δ_{Ts}	+200 0	+200 0	+200 0	+200 0	+200 -200	+500 -250	+350 -250	+350 -250	+400 -400	+400 -400	+400 -500	+600 -600

Tolerance Class P5

Deviation	$\Delta_{\text{dmp}}, \Delta_{\text{ds}}$	0 -7	0 -8	0 -10	0 -12	0 -15	0 -18	0 -22	-25	-30	-35	-40	-60
Variation	V_{dp}	5	6	8	9	11	14	17					
	V_{dmp}	5	5	5	6	8	9	11					
Width Variation	Δ_{Bs}	0 -200	0 -200	0 -240	0 -300	0 -400	0 -500	0 -600	-700	-800	-800	-800	-800
Radial Runout	K_{ia}	3.5	4	5	5	6	8	10	13	15	18	20	22
Side Face Runout	S_{d}	7	8	8	8	9	10	11	13	15	19	22	27
Width Deviation	Δ_{Ts}	+200 -200	+200 -200	+200 -200	+200 -200	+200 -200	+350 -250	+350 -250	+350 -250	+400 -400	+400 -400	+500 -500	+600 -600

- Note :
1. The larger Δ_{dmp} and the smaller Δ_{dmp} in the table do not apply when the width of raceway face is within 1.2 times the maximum fillet radius.
 2. A part of this Table complies with the specifications of KBC.

Outer Ring

Dimension (Unit : mm)

Nominal Outside Diameter	Over Up to	18 30	30 50	50 80	80 120	120 150	150 180	180 250	250 315	315 400	400 500	500 630	630 800	800 1000
--------------------------	------------	----------	----------	----------	-----------	------------	------------	------------	------------	------------	------------	------------	------------	-------------

Tolerance Class P6

Variation (Unit : μm)

Deviation	Δ_{Dmp}	0 -8	0 -9	0 -11	0 -13	0 -15	0 -18	0 -20	0 -25	0 -28	0 -33	0 -38	0 -45	0 -60
Variation	V_{Dp}	8	9	11	13	15	18	20	25	28				
	V_{Dmp}	6	7	8	10	11	14	15	19	21				
Width Deviation	Δ_{Cs}	The width tolerances Δ_{Cs} are same as Δ_{Bs} of inner ring, respectively.												
Radial Runout	K_{ea}	9	10	13	18	20	23	25	30	35	40	50	60	75

Tolerance Class P5

Deviation	$\Delta_{Dmp}, \Delta_{Ds}$	0 -8	0 -9	0 -11	0 -13	0 -15	0 -18	0 -20	0 -25	0 -28	-33	-38	-45	-60
Variation	V_{Dp}	6	7	8	10	11	14	15	19	22				
	V_{Dmp}	5	5	6	7	8	9	10	13	14				
Width Deviation	Δ_{Cs}	The width tolerances Δ_{Cs} are same as Δ_{Bs} of inner ring, respectively.												
Radial Runout	K_{ea}	6	7	8	10	11	13	15	18	20	23	25	30	35
Inclination	S_D	8	8	8	9	10	10	11	13	13	15	18	20	23

7. Dimensional and Running Accuracy of Bearings

Table 7-4 Tolerances of Inch Series Tapered Roller Bearings

Inner Ring

Dimension (Unit : mm)

Nominal Bore Diameter	Over Up to	76.2	76.2 266.7	266.7 304.8	304.8 609.6	609.6 914.4	914.4 1219.2	1219.2
-----------------------	------------	------	---------------	----------------	----------------	----------------	-----------------	--------

Tolerance Class AFBMA 4

Tolerance (Unit : μm)

Deviation	Δ_{ds}	+13 0	+25 0	+25 0	+51 0	+76 0	+102 0	+127 0
-----------	---------------	----------	----------	----------	----------	----------	-----------	-----------

Tolerance Class AFBMA 2

Deviation	Δ_{ds}	+13 0	+25 0	+25 0	+51 0	+76 0	+102 0	+127 0
-----------	---------------	----------	----------	----------	----------	----------	-----------	-----------

Tolerance Class AFBMA 3

Deviation	Δ_{ds}	+13 0	+13 0	+13 0	+25 0	+28 0	+51 0	+76 0
-----------	---------------	----------	----------	----------	----------	----------	----------	----------

Tolerance Class AFBMA 0

Deviation	Δ_{ds}	+13 0	+13 0	+13 0	+25 0	+28 0	+51 0	+76 0
-----------	---------------	----------	----------	----------	----------	----------	----------	----------

Deviation of Single Overall Width

Dimension (Unit : mm)

Nominal Bore Diameter	Over Up to	101.6	101.6 304.8	304.8 609.6	609.6
-----------------------	------------	-------	----------------	----------------	-------

Tolerance Class AFBMA 4

Tolerance (Unit : μm)

Deviation	Δ_{Ts}	+203 0	+356 -254	+381 -381	+381 -381
-----------	---------------	-----------	--------------	--------------	--------------

Tolerance Class AFBMA 2

Deviation	Δ_{Ts}	+203 0	+203 0	+381 -381
-----------	---------------	-----------	-----------	--------------

Tolerance Class AFBMA 3

Deviation	Δ_{Ts}	D ≤ 508mm In Case of	+203 -203	+203 -203	+203 -203	+381 -381
		D > 508mm In Case of	+203 -203	+203 -203	+203 -203	+381 -381

Tolerance Class AFBMA 0

Deviation	Δ_{Ts}	+203 -203	+203 -203
-----------	---------------	--------------	--------------

Outer Ring

Dimension(Unit : mm)

Nominal outside Diameter	Over Up to	266.7	266.7 304.8	304.8 609.6	609.6 914.4	914.4 1219.2	1219.2
--------------------------	------------	-------	----------------	----------------	----------------	-----------------	--------

Tolerance Class AFBMA 4

Tolerance(Unit : μm)

Deviation	Δ_{D_s}	+25 0	+25 0	+51 0	+76 0	+102 0	+127 0
Radial Runout	K_{Ia}, K_{Ea}	51	51	51	76	76	76

Tolerance Class AFBMA 2

Deviation	Δ_{D_s}	+25 0	+25 0	+51 0	+76 0	+102 0	+127 0
Radial Runout	K_{Ia}, K_{Ea}	38	38	38	51		

Tolerance Class AFBMA 3

Deviation	Δ_{D_s}	+13 0	+13 0	+25 0	+38 0	+51 0	+76 0
Radial Runout	K_{Ia}, K_{Ea}	8	8	18	51	76	76

Tolerance Class AFBMA 0

Deviation	Δ_{D_s}	+13 0	+13 0	+25 0	+38 0	+51 0	+76 0
Radial Runout	K_{Ia}, K_{Ea}	4	4				

7. Dimensional and Running Accuracy of Bearings

Table 7-5 Tolerances of Thrust Ball Bearings(One Way Flat Washer Type)

Shaft Washer

Dimension(Unit : mm)

Nominal Bore Diameter	Over Up to	18	18 30	30 50	50 80	80 120	120 180	180 250	250 315	315 400	400 500	500 630	630 800	800 1000	1000 1250
-----------------------	------------	----	----------	----------	----------	-----------	------------	------------	------------	------------	------------	------------	------------	-------------	--------------

Tolerance Class AFBMA 0

Tolerance(Unit : μm)

Deviation	Δ_{dmp}	0 -8	0 -10	0 -12	0 -15	0 -20	0 -25	0 -30	0 -35	0 -40	0 -45	0 -50	0 -75	0 -100	0 -125
Variation	V_{dp}	6	8	9	11	15	19	23	26	30	34	38			
Thickness Variation	S_t	10	10	10	10	15	15	20	25	30	30	35	40	45	50

Tolerance Class AFBMA P6

Deviation	Δ_{dmp}	0 -8	0 -10	0 -12	0 -15	0 -20	0 -25	0 -30	0 -35	0 -40	0 -45	0 -50	0 -75	0 -100	0 -125
Variation	V_{dp}	6	8	9	11	15	19	23	26	30	34	38			
Thickness Variation	S_t	5	5	6	7	8	9	10	13	15	18	21	25	30	35

Tolerance Class AFBMA P5

Deviation	Δ_{dmp}	0 -8	0 -10	0 -12	0 -15	0 -20	0 -25	0 -30	0 -35	0 -40	0 -45	0 -50	0 -75	0 -100	0 -125
Variation	V_{dp}	6	8	9	11	15	19	23	26	30	34	38			
Thickness Variation	S_t	3	3	3	4	4	5	5	7	7	9	11	13	15	18

Tolerance Class AFBMA P4

Deviation	Δ_{dmp}	0 -7	0 -8	0 -10	0 -12	0 -15	0 -18	0 -22	0 -25	0 -30	0 -35	0 -40	0 -50		
Variation	V_{dp}	5	6	8	9	11	14	17	19	23	26	30			
Thickness Variation	S_t	2	2	2	3	3	4	4	5	5	6	7	8		

High

Dimension(Unit : mm)

Nominal Bore Diameter	Over Up to	30	30 50	50 80	80 120	120 180	180 250	250 315	315 400
-----------------------	------------	----	----------	----------	-----------	------------	------------	------------	------------

Tolerance Class AFBMA 0...P4

Tolerance(Unit : μm)

Deviation	Δ_{Hs}	0 -75	0 -100	0 -125	0 -150	0 -175	0 -200	0 -225	0 -300
-----------	---------------	----------	-----------	-----------	-----------	-----------	-----------	-----------	-----------

Housing Washer

Dimension(Unit : mm)

Nominal outside Diameter	Over Up to	10 18	18 30	30 50	50 80	80 120	120 180	180 250	250 315	315 400	400 500	500 630	630 800	800 1000	1000 1250
--------------------------	------------	----------	----------	----------	----------	-----------	------------	------------	------------	------------	------------	------------	------------	-------------	--------------

Tolerance Class AFBMA 0

Tolerance(Unit : μm)

Deviation	Δ_{Dmp}	0 -11	0 -13	0 -16	0 -19	0 -22	0 -25	0 -30	0 -35	0 -40	0 -45	0 -50	0 -75	0 -100	0 -125
Variation	V_{Dp}	8	10	12	14	17	19	23	26	30	34	38	55	75	
Thickness Variation	S_e	Thickness variation S_e of housing washer is same as that of shaft washer S_i													

Tolerance Class AFBMA P6

Deviation	Δ_{Dmp}	0 -11	0 -13	0 -16	0 -19	0 -22	0 -25	0 -30	0 -35	0 -40	0 -45	0 -50	0 -75	0 -100	0 -125
Variation	V_{Dp}	8	10	12	14	17	19	23	26	30	34	38	55	75	
Thickness Variation	S_e	Thickness variation S_e of housing washer is same as that of shaft washer S_i													

Tolerance Class AFBMA P5

Deviation	Δ_{Dmp}	0 -11	0 -13	0 -16	0 -19	0 -22	0 -25	0 -30	0 -35	0 -40	0 -45	0 -50	0 -75	0 -100	0 -125
Variation	V_{Dp}	8	10	12	14	17	19	23	26	30	34	38	55	75	
Thickness Variation	S_e	Thickness variation S_e of housing washer is same as that of shaft washer S_i													

Tolerance Class AFBMA P4

Deviation	Δ_{Dmp}	0 -7	0 -8	0 -9	0 -11	0 -13	0 -15	0 -20	0 -25	0 -28	0 -33	0 -38	0 -45		
Variation	V_{Dp}	5	6	7	8	10	11	15	19	21	25	29	34		
Thickness Variation	S_e	Thickness variation S_e of housing washer is same as that of shaft washer S_i													

7. Dimensional and Running Accuracy of Bearings

Table 7-6 Tolerances of Chamfer Dimensions

Code		$r_{\min}^*)$	Min, Chamfer Dimension
			$r_{1\min}, r_{2\min}, r_{3\min}, r_{4\min}$
r_1, r_3	Radial Chamfer Dimension	$r_{1\max}, r_{3\max}$	Max, Radial Chamfer Dimension
r_2, r_4	Axial Chamfer Dimension	$r_{2\max}, r_{4\max}$	Min, Axial Chamfer Dimension

Chamfer Dimension of Radial Bearings(Except Tapered Roller Bearings)

r_{\min}	Nominal Bore Diameter d	Over up to	Unit : mm												
			0.1	0.15	0.2	0.3	0.6	1	1.1	1.5	2	3	4	5	
						40	40	40	40	50	50	120	120	120	120
$r_{1\max}$			0.2	0.3	0.5	0.6	0.8	1	1.3	1.5	1.9	2	2.5	2.3	3
$r_{2\max}$			0.4	0.6	0.8	1	1	2	2	3	3	3.5	4	4	5

Chamfer Dimensions of Tapered Roller Bearings

Inner Ring

r_{\min}	Nominal Bore Diameter d	Over up to	Unit : mm												
			0.3	0.6	1	1.5	2	3	4	5	6	8			
			40	40	40	40	50	50	120	120	250	120	120	250	250
$r_{1\max}$			0.7	0.9	1.1	1.3	1.6	1.9	2.3	2.8	3.5	2.8	3.5	4	
$r_{2\max}$			1.4	1.6	1.7	2	2.5	3	3	3.5	4	4	4.5	5	

Outer Ring

r_{\min}	Nominal Outside Diameter D	Over up to	Unit : mm												
			0.3	0.6	1	1.5	2	3	4	5	6	8			
			40	40	40	40	50	50	120	120	250	120	120	250	250
$r_{3\max}$			0.7	0.9	1.1	1.3	1.6	1.9	2.3	2.8	3.5	2.8	3.5	4	
$r_{4\max}$			1.4	1.6	1.7	2	2.5	3	3	3.5	4	4	4.5	5	

Chamfer Dimension of Thrust Bearings

r_{\min}	Unit : mm																		
	0.1	0.15	0.2	0.3	0.6	1	1.1	1.5	2	2.1	3	4	5	6	7.5	9.5	12	15	19
$r_{1\max}, r_{2\max}$	0.2	0.3	0.5	0.8	1.5	2.2	2.7	3.5	4	4.5	5.5	6.5	8	10	12.5	15	18	21	25

) The Min, chamfer dimensions in accordance with ISO 582 and KS B 2013 are listed in the Dimension Tables
The dimensions of fillet radius of shaft and housing are determined by using these values.

Radial Bearings

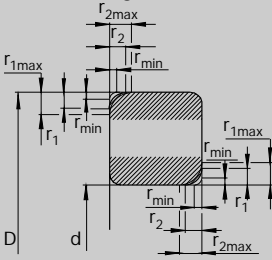

Tapered Roller Bearings

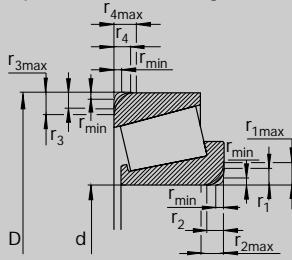

Thrust Bearings

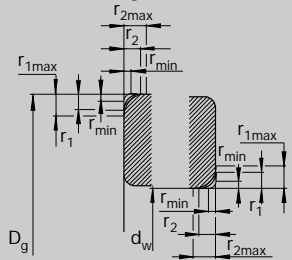

2			2.1		2.5			3		4	5	6	7.5	9.5	12	15	19
80	80 220	220	280	280	100	100 280	280	280	280								
3	3.5	3.8	4	4.5	3.8	4.5	5	5	5.5	6.5	8	10	12.5	15	18	21	25
4.5	5	6	6.5	7	6	6	7	8	8	9	10	13	17	19	24	30	38

2.5			3				4			5		6					
120	120 250	250	120	120 250	250 400	400	120	120 250	250 400	400	180	180	180	180			
3.5	4	4.5	4	4.5	5	5.5	5	5.5	6	6.5	6.5	7.5	7.5	9			
5	5.5	6	5.5	6.5	7	7.5	7	7.5	8	8.5	8	9	10	11			

2.5			3				4			5		6					
120	120 250	250	120	120 250	250 400	400	120	120 250	250 400	400	180	180	180	180			
3.5	4	4.5	4	4.5	5	5.5	5	5.5	6	6.5	6.5	7.5	7.5	9			
5	5.5	6	5.5	6.5	7	7.5	7	7.5	8	8.5	8	9	10	11			

Chamfer Dimensions of Inch Series Tapered Roller Bearings (ISO 1123)

Inner Ring

Nominal Bore Diameter D	Over Up to	Unit : mm		
		50.8	101.6	254
		50.8	101.6	

r_{1max}	Tolerance : mm		
	$r_{min} + 0.38$	$r_{min} + 0.51$	$r_{min} + 0.64$
r_{2max}	$r_{min} + 0.89$	$r_{min} + 1.27$	$r_{min} + 1.78$

Outer Ring

Nominal Outside Diameter D	Over Up to	Unit : mm		
		101.6	168.3	266.7
		101.6	168.3	266.7

r_{3max}	Tolerance : mm			
	$r_{min} + 0.58$	$r_{min} + 0.64$	$r_{min} + 0.84$	$r_{min} + 1.7$
r_{4max}	$r_{min} + 1.07$	$r_{min} + 1.17$	$r_{min} + 1.35$	$r_{min} + 1.7$

8. Fits

8. Fits

8-1 Importance of Correct Fits

For bearings to serve their function well, both shaft fit of inner ring and housing fit of outer ring have to be appropriate for their specific use.

Therefore, fitting is as important as selecting an appropriate bearing, and improper fitting will shorten the bearing life.

Common symptoms caused by improper fitting are creeping, rupture of rings, and indentation on raceway at ball pitch intervals by rolling element, etc.

Creeping usually happens when bearing is mounted on the shaft with almost no interference, causing the inner/outer rings to move relatively in circumferential direction against the shaft or housing, which generates excessive heat or wear, and leaves scratches on fitted surface.

If this happens, the peeled-off metal particles may enter the inside of the bearing. This may shorten the bearing life.

When interference is excessively large, rings could even crack in circumferential direction due to large hoop stress, and narrowing of bearing clearance generates excessive stress between rolling element and ring, which, in return, may leave the indentation marks on the rings at ball pitch intervals.

The following aspects should be taken into account when selecting the fit.

- The bearing rings should be well supported on their circumference, so that the load carrying capacity of the bearing is fully utilized.
- The inner/outer rings should not move on their mating parts, otherwise seats will be damaged.
- One of the floating bearing rings must be able to accommodate length variations of shaft and housing, which means it is axially adjustable. (Except the bearings of split type, of which inner/outer rings are freely, axially displaceable.)
- High loads, especially shock loads, require a larger interference and tighter tolerances.

- The radial clearance changes with tight fits and temperature gradient between inner and outer rings. Therefore, this should be taken into consideration when selecting the radial clearance group.
- Mounting and dismounting of bearings should be easy and convenient.

8-2 Selection of Fits

The basic factor in fit selection for bearings is whether the direction of applied load is rotating or stationary in relation to the bearing ring.

If an applied load is rotating in relation to its ring, then it is called a circumferential load, and if it is constantly directed at the same point, a point load.



For some machines with not so simple operating conditions, it will be difficult to determine whether it is a circumferential or point load.



For example, for a machine with fast rotating element, a certain load is applied to the rolling element by its weight load. This, in return, causes generation of the rotating load, because its rolling element is dynamically unbalanced.

When an operating load of a machine is applied to this combined load, its directions vary even more widely, which is why the fits have to be carefully selected.

Fitting conditions for each kind of applied loads are shown in Table 8-1.

Table 8-1 Proper Fits for Various Loads

Bearing Motions	Examples	Illustration	Loading Conditions	Fits
Rotating inner Ring Stationary Outer Ring Constant Direction	Weight suspended by the shaft Driving wheel of automotive vehicles	 Weight	Circumferential load on inner ring	Inner ring: Tight fit mandatory
Fixed Inner Ring Rotating Outer Ring Directions of Load Rotating with Outer Ring	Imbalance load applied to outer ring	 Imbalance load		

Bearing Motions	Examples	Illustration	Loading a Conditions	Fits
Stationary Inner Ring Rotating Outer Ring Constant Direction Load	Non-driven wheel of automotive vehicles Conveyor idler	 Weight	Point load on Inner Ring	Inner ring: slide fit Permissible
Rotating Inner Ring Stationary Outer Ring Direction of Load Rotating with Outer Ring	Centrifuge Vibrating screen	 Imbalance Load		

8. Fits

8-3 Calculation of Fitting Tolerances

When selecting the fitting tolerances, the minimum interference has to be determined first, considering varying fits depending on the kinds of applied loads to bearing and the temperature gradient of mounted parts, the interference variations caused by surface roughness when fitting, and the effect of centrifugal force generated by fast rotation, etc.

Furthermore, the hoop stress applied to the inner/outer rings of bearing has to be considered to prevent the bearing from being damaged.

8-3-1 Minimum Required Interference

(1) Influences by Load

When radial load is applied to bearing, clearance can be created in some parts of the unloaded zone because of the reduced interference.

The minimum amount of interference, which will be used for prevention of clearance generated by the loads, can be obtained by using the following Equations.

- In case of $F_r \leq 0.2C_{0r}$

$$\Delta_{dF} = 0.08 \sqrt{\frac{d \cdot F_r}{B}} \dots \dots \dots \text{(Equation 8-1)}$$

- In case of $F_r > 0.2C_{0r}$

$$\Delta_{dF} = 0.02 \frac{F_r}{B} \dots \dots \dots \text{(Equation 8-2)}$$

Where,

- Δ_{dF} : Reduction in inner ring interference by the load [μm]
- d : Bearing bore diameter [mm]
- B : Width of bearing inner ring [mm]
- F_r : Radial load applied to bearing [N]
- C_{0r} : Bearing's static load rating [N]

(2) Influences by Temperature

When bearing becomes hotter during operation, the amount of interference of fitting surface of bearing rings can be either increased or decreased. The variations of interference caused by temperature rises of fitting surface, bearing, or surrounding parts can be calculated by using the Equations below.

$$\Delta_{dT} = (\alpha_{Bi} - \alpha_S) \Delta_{TS} \cdot d \dots \dots \dots \text{(Equation 8-3)}$$

$$\Delta_{DT} = (\alpha_H - \alpha_{Bo}) \Delta_{TH} \cdot D \dots \dots \dots \text{(Equation 8-4)}$$

Where,

- Δ_{dT} : Interference variation by temperature difference between bearing's inner ring and shaft [μm]
- Δ_{DT} : Interference variation by temperature difference between bearing's outer ring and housing. [μm]
- Δ_{TS} : Temperature difference between seated surface area of inner ring and shaft, and the surrounding area of housing. [$^{\circ}\text{C}$]
- Δ_{TH} : Temperature difference between seated surface area of outer ring and housing, and the surrounding area of housing. [$^{\circ}\text{C}$]
- α_{Bi} : Linear expansion coefficient of inner ring material. [$1/^{\circ}\text{C}$]
- α_S : Linear expansion coefficient of shaft material [$1/^{\circ}\text{C}$]
- α_H : Linear expansion coefficient of housing material [$1/^{\circ}\text{C}$]
- α_{Bo} : Linear expansion coefficient of outer ring material [$1/^{\circ}\text{C}$]

- d : Bearing bore diameter [mm]
- D : Bearing outer diameter [mm]

For practical use, when bearing becomes hotter due to its rotation, the minimum interference required for proper fits of inner ring and shaft can be obtained, by using the Equation below.

$$\Delta_{dT} = 0.0015 \cdot d \cdot \Delta_T \dots\dots\dots \text{(Equation 8-5)}$$

Where,

Δ_{dT} : Reduction in interference by temperature difference [μm]

Δ_T : Temperature difference between bearing inside and the surrounding housing [°C]

(3) Influences by Surface Roughness and Plastic Deformation

Plastic deformation occurs in the fitted area because of the mounting force and interference, and this is why the amount of residual interference measured after fitting is smaller than the theoretical value calculated by presuming various fitting conditions. And the magnitude of variation depends on the degree of roughness of both fitted surfaces. The reductions in interference in relation to surface roughness are shown in Table 8-2.

Table 8-2 Interference Reduction by Fabrication Precision

Fabrication Precision	Surface Roughness R_a [μm]	Reduction of interference [μm]
Super Precision Grinding	0.8	≈ 1.0
Precision Grinding	2.0	≈ 2.5
Super Precision Lathe-Turning	4.0	≈ 5.0
Precision Lathe-Turning	6.0	≈ 7.0

(4) Influences by Centrifugal Force

When bearing is rotating at a high speed, the interference of inner ring and shaft can vary due to the radial expansion of inner ring. However, it is recommended and practical to take the centrifugal force restrictively into consideration only when the bearing is operated above its permissible speed

8-3-2 Maximum Interference

The fitting interference causes the mounting seats of surrounding structures, such as bearing, its shaft, and housing, not only to expand or contract, but also to generate the surface stress. The surface stress and the max circumferential stress generated in the mounting seats by fitting interference can be calculated by using the Equations below,

and for the heat-treated bearing steel, the material tensile strength generally lies in the range of 1570 ~1960MPa, so it is safe to set up the fitting conditions, so that the max. circumferential stress generated by fitting interference does not exceed 130MPa.

$$P_{mi} = \frac{\Delta d_{eff}/d}{\frac{1}{E_{Bi}} \left[\frac{k^2 + 1}{k^2 - 1} + m_{Bi} \right] + \frac{1}{E_S} \left[\frac{k_o^2 + 1}{k_o^2 - 1} - m_S \right]} \dots\dots\dots \text{(Equation 8-6)}$$

$$P_{mo} = \frac{\Delta D_{eff}/D}{\frac{1}{E_{Bo}} \left[\frac{h^2 + 1}{h^2 - 1} - m_{Bo} \right] + \frac{1}{E_H} \left[\frac{h_o^2 + 1}{h_o^2 - 1} + m_H \right]} \dots\dots\dots \text{(Equation 8-7)}$$

$$\sigma_{imax} = P_{mi} \cdot \frac{k^2 + 1}{k^2 - 1} \dots\dots\dots \text{(Equation 8-8)}$$

$$\sigma_{omax} = P_{mo} \cdot \frac{2h^2}{h^2 - 1} \dots\dots\dots \text{(Equation 8-9)}$$

Where,

$\Delta d_{eff}, \Delta D_{eff}$: Effective interference of fitting surface of inner/outer ring. [mm]

d : Shaft diameter or bearing bore diameter [mm]

d_{Bi} : Mean outer diameter of bearing inner ring [mm]

D_S : Outer diameter of hollow shaft [mm]

D : Inner diameter of housing or bearing outer diameter [mm]

d_H : Outer diameter of housing [mm]

D_{Bo} : Mean inner diameter of bearing outer ring [mm]

E_{Bi}, E_{Bo} : Elastic modulus of bearing inner/outer rings [N/mm²]

E_S, E_H : Elastic modulus of materials of shaft and housing [N/mm²]

8. Fits

m_{Bi}, m_{Bo} : Poisson' s ratio of Bearing inner/outer rings

m_S, m_H : Poisson' s ratio of shaft and housing

k : $= d_{Bi} / d$

k_o : $= d / D_S$

h : $= D / D_{Bo}$

h_o : $= d_H / D$

P_{mi} : Surface stress of mounted seat generated by fitting interference between bearing inner ring and shaft. [N/mm²]

P_{mo} : Surface stress of mounted seat generated by fitting interference between bearing outer ring and housing. [N/mm²]

σ_{imax} : Max. circumferential stress of the mounted seats generated by fitting interference

ce between bearing inner ring and shaft. [N/mm²]

σ_{tomax} : Max. circumferential stress of the mounted seats generated by fitting interference between bearing outer ring and housing. [N/mm²]

Table 8-3 Recommended Shaft Tolerances for Radial Bearings(Cylindrical Bore Diameter)

Type of Load	Bearing Type	Shaft Diameter	Axial Displacement Ability and Load Magnitude	Tolerances
Point Load on Inner Ring	Ball, Roller, and Needle Roller Bearings	All sizes	Floating bearings with sliding inner ring	g6 (g5)
			Angular contact ball bearings and tapered roller bearings with adjustable preload of inner ring	h6 (j6)
Circumferential Load on Inner Ring or Indeterminate Load	Ball Bearings	Up to 40mm	Normal load	j6 (j5)
		Up to 100mm	Low load	j6 (j5)
			Normal and high load	k6 (k5)
			High load Shocks	n6 (n5)
		Up to 200mm	Low load	k6 (k5)
			Normal and high load	m6 (m5)
	Roller and Needle Roller Bearings	Up to 60mm	Low load	j6 (j5)
			Normal and high load	k6 (k5)
		Up to 200mm	Low load	k6 (k5)
			Normal load	m6 (m5)
			High load	n6 (n5)
		Up to 500mm	Normal load	m6 (n6)
			High load Shocks	p6
		Over 500mm	Normal load	n6 (p6)
High load	p6			

8-4 Recommended Fits

The most generally recommended fitting tolerances of radial bearings are shown in Table 8-3 and 8-4, and in Table 8-5 for deep groove ball bearing with CM clearance, and in Table 8-6 and 8-7 for inch series tapered roller bearings.

Also, in Table 8-8 and 8-9, the interferences for

each tolerance class of “KS Class 0” radial bearings and their shaft and housing are shown.

Table 8-4 Recommended Housing Tolerances for Radial Bearings

Type of Load	Axial Displacement Ability and Load Magnitude	Operating Conditions	Tolerances
Point Load on Outer Ring	Floating Side Bearing	Closeness of tolerances based on required running accuracy.	H7(H6)
	Easily Adjustable Outer Ring		
	Outer ring generally displaceable, angular contact ball bearings and tapered roller bearings with adjustment via outer ring.	Requires high running accuracy	H6(J6)
		Requires normal running accuracy	H7(J7)
	Heat dissipation through shaft	G7	
Circumferential Load on Outer Ring or Indeterminate Load	Low load	K6, M6, N6, and P6, when high running accuracy is required.	K7(K6)
	Normal load shocks		M6(M6)
	high load shocks		N7(N6)
	High load, severe impact, thin housing		N7(P6)

Table 8-5 Recommended Fitting Tolerances for Deep Groove Ball Bearings of Clearance Class CM

Bearing Bore Diameter	Shaft Tolerances	Housing Tolerances
Over Up to		
10 ¹⁾ 18	js5(j5)	H6...H7 or Js6...Js7 (J6...J7)
18 30	k5	
30 50		
50 80		
80 100		
100 120	m5	

1) Including 10mm

8. Fits

Table 8-6 Recommended Shaft Tolerances of Inch Series Tapered Roller Bearings

AFBMA CLASS 4 AND CLASS 2

Operating Conditions		Bearing Bore Diameter d		Shaft Tolerances		Remarks
		mm	mm	μm	μm	
		Over	Up to	min	max	
Circumferential Load on Inner Ring	Load without Impact	- 76.2 304.8 609.6	76.2 304.8 609.6 914.4	+38 +64 +127 +190	+25 +38 +76 +114	For bearings with $d \leq 152.4$, the bearings with larger clearance than normal are generally used.
	High Load, Impact Load, High Speed Rotation	- 76.2 304.8 609.6	76.2 304.8 609.6 914.4	+64 A A +381	+38 +305	
Circumferential Load on Outer Ring	High Load, Impact Load, High Speed Rotation	- 76.2 304.8 609.6	76.2 304.8 609.6 914.4	+64 A A +381	+38 +305	The average interference of "A" should be approximately 0.0005d.
	Normal Load without Impact(When placed apart from ground surface)	- 76.2 304.8 609.6	76.2 304.8 609.6 914.4	+13 +25 +51 +76	0 0 0 0	
	Normal Load without Impact(When it touches the ground surface)	- 76.2 304.8 609.6	76.2 304.8 609.6 914.4	0 0 0 0	-13 -25 -51 -76	

AFBMA CLASS 3 AND CLASS 0 1)

Operating Conditions		Bearing Bore Diameter d		Shaft Tolerances		Remarks
		mm	mm	μm	μm	
		Over	Up to	min	max	
Circumferential Load on Inner Ring	Main Shaft of Precision Tools	- 76.2 304.8 609.6	76.2 304.8 609.6 914.4	+13 +13 +25 +38	0 0 0 0	The minimum interference of "B" should be approximately 0.00025d.
	High Load, Impact Load, High Speed Rotation	- 76.2 304.8 609.6	76.2 304.8 609.6 914.4	B B B B		
Circumferential Load on Outer Ring	Main Shaft of Precision Tools	- 76.2 304.8 609.6	76.2 304.8 609.6 914.4	+13 +13 +25 +38	0 0 0 0	

1) There are no Class 0 bearings for the ones with bore diameter(d) larger than 304.8mm.

Table 8-7 Recommended Housing Tolerances of Inch Series Tapered Roller Bearings

AFBMA CLASS 4 AND CLASS 2

Operating Conditions		Bearing Bore Diameter D		Housing Tolerances		Remarks
		mm	mm	μm	μm	
		Over	Up to	min	max	
Circumferential Load on Inner Ring	When used in Floating or Locating Sides	-	76.2	+76	+51	Axially displaceable outer ring
		76.2	127	+76	+51	
		127	304.8	+76	+51	
304.8		609.6	+152	+102		
		609.6	914.4	+229	+152	
	Outer ring can be displaced axially.	-	76.2	+25	0	Axially displaceable outer ring
		76.2	127	+25	0	
		127	304.8	+51	0	
		304.8	609.6	+76	+25	
		609.6	914.4	+127	+51	
	Outer ring can not be displaced axially.	-	76.2	-13	-38	Axially non-displaceable outer ring
		76.2	127	-25	-51	
		127	304.8	-25	-51	
		304.8	609.6	-25	-76	
		609.6	914.4	-25	-102	
Circumferential Load on Outer Ring	Outer ring can not be displaced axially.	-	76.2	-13	-38	Axially non-displaceable outer ring
		76.2	127	-25	-51	
		127	304.8	-25	-51	
		304.8	609.6	-25	-76	
		609.6	914.4	-25	-102	

AFBMA CLASS 3 AND CLASS 0 1)

Operating Conditions		Bearing Bore Diameter D		Housing Tolerances		Remarks
		mm	mm	μm	μm	
		Over	Up to	min	max	
Circumferential Load on Inner Ring	Used in Floating Side	-	152.4	+38	+25	Axially displaceable outer ring
		152.4	304.8	+38	+25	
		304.8	609.6	+64	+38	
		609.6	914.4	+89	+51	
	Used in Locating Side	-	152.4	+25	+13	Axially displaceable outer ring
		152.4	304.8	+25	+13	
		304.8	609.6	+51	+25	
		609.6	914.4	+76	+38	
	Outer ring can be displaced axially.	-	152.4	+13	0	Axially displaceable outer ring
		152.4	304.8	+25	0	
		304.8	609.6	+25	0	
		609.6	914.4	+38	0	
	Outer ring can not be displaced axially.	-	152.4	0	-13	Axially non-displaceable outer ring
		152.4	304.8	0	-25	
		304.8	609.6	0	-25	
		609.6	914.4	0	-38	
Circumferential Load on Outer Ring	Outer ring can not be displaced axially.	-	76.2	-13	-25	Axially non-displaceable outer ring
		76.2	152.4	-13	-25	
		152.4	304.8	-13	-38	
		304.8	609.6	-13	-38	
		609.6	914.4	-13	-51	

1) There are no Class 0 bearings for the ones with outer diameter(D) larger than 304.8mm.

8. Fits

Table 8-8 Comparisons of Fitting Interferences of "KS Class 0" Radial Bearings and Shafts

Bearing Bore Diameter d		Mean Bore Diameter Deviation (Δ_{dmp}^1)		g5 Bearing Shaft	g6 Bearing Shaft	h5 Bearing Shaft	h6 Bearing Shaft	j5 Bearing Shaft	js5 Bearing Shaft	j6 Bearing Shaft
mm Over	Up to	mm Upper	Lower							
3	6	0	-8	4T...9L	4T...12L	8T...5L	8T...8L	11T...2L	10.5T...2.5L	14T...2L
6	10	0	-8	3T...11L	3T...14L	8T...6L	8T...9L	12T...2L	11T...3L	15T...2L
10	18	0	-8	2T...14L	2T...17L	8T...8L	8T...11L	13T...3L	12T...4L	16T...3L
18	30	0	-10	3T...16L	3T...20L	10T...9L	10T...13L	15T...4L	14.5T...4.5L	19T...4L
30	50	0	-12	3T...20L	3T...25L	12T...11L	12T...16L	18T...5L	17.5T...5.5L	23T...5L
50	80	0	-15	5T...23L	5T...29L	15T...13L	15T...19L	21T...7L	21.5T...6.5L	27T...7L
80	120	0	-20	8T...27L	8T...34L	20T...15L	20T...22L	26T...9L	27.5T...7.5L	33T...9L
120	140	0	-25	11T...32L	11T...39L	25T...18L	25T...25L	32T...11L	34T...9L	39T...11L
140	160			15T...35L	15T...44L	30T...20L	30T...29L	37T...13L	40T...10L	46T...13L
160	180			18T...40L	18T...49L	35T...23L	35T...32L	42T...16L	46.5T...11.5L	51T...16L
250	280	0	-35	22T...43L	22T...54L	40T...25L	40T...36L	47T...18L	52.5T...12.5L	58T...18L
315	355			25T...47L	25T...60L	45T...27L	45T...40L	52T...20L	58.5T...13.5L	65T...20L
400	450	0	-45							

1) The tolerances, for the tapered roller bearings with 30mm of bearing bore diameter(d) or lower, are different from the values shown in this Table.

Table 8-9 Comparisons of Fitting Interferences of "KS Class O" Radial Bearings and Housings

Bearing Outer Diameter D		Mean outer Diameter Deviation (Δ_{Dmp}^1)		G7 Housing Bearing	H6 Housing Bearing	H7 Housing Bearing	J6 Housing Bearing	J7 Housing Bearing	Js7 Housing Bearing	K6 Housing Bearing
mm Over	Up to	mm Upper	Lower							
6	10	0	-8	5L...28L	0...17L	0...23L	4T...13L	7T...16L	7.5T...15.5L	7T...10L
10	18	0	-8	6L...32L	0...19L	0...26L	5T...14L	8T...18L	9T...17L	9T...10L
18	30	0	-9	7L...37L	0...22L	0...30L	5T...17L	9T...21L	10.5T...19.5L	11T...11L
30	50	0	-11	9L...45L	0...27L	0...36L	6T...21L	11T...25L	12.5T...23.5L	13T...14L
50	80	0	-13	10L...53L	0...32L	0...43L	6T...26L	12T...31L	15T...28L	15T...17L
80	120	0	-15	12L...62L	0...37L	0...50L	6T...31L	13T...37L	17.5T...32.5L	18T...19L
120	150	0	-18	14L...72L	0...43L	0...58L	7T...36L	14T...44L	20T...38L	21T...22L
150	180	0	-25	14L...79L	0...50L	0...65L	7T...43L	14T...51L	20T...45L	21T...29L
180	250	0	-30	15L...91L	0...59L	0...76L	7T...52L	16T...60L	23T...53L	24T...35L
250	315	0	-35	17L...104L	0...67L	0...87L	7T...60L	16T...71L	26T...61L	27T...40L
315	400	0	-40	18L...115L	0...76L	0...97L	7T...69L	18T...79L	28.5T...68.5L	29T...47L
400	500	0	-45	20L...128L	0...85L	0...108L	7T...78L	20T...88L	31.5T...76.5L	32T...53L

1) The tolerances, for the tapered roller bearings with 150mm of bearing outer diameter(D) or lower, are different from the values shown in this Table.

js6 Bearing Shaft	k5 Bearing Shaft	k6 Bearing Shaft	m5 Bearing Shaft	m6 Bearing Shaft	n6 Bearing Shaft	p6 Bearing Shaft	r6 Bearing Shaft
12T...4L	14T...1T	17T...1T	17T...4T	20T...4T	24T...8T	28T...12T	--
12.5T...4.5L	15T...1T	18T...1T	20T...6T	23T...6T	27T...10T	32T...15T	--
13.5T...5.5L	17T...1T	20T...1T	23T...7T	26T...7T	31T...12T	37T...18T	--
16.5T...6.5L	21T...2T	25T...2T	27T...8T	31T...8T	38T...15T	45T...22T	--
20T...8L	25T...2T	30T...2T	32T...9T	37T...9T	45T...17T	54T...26T	--
24.5T...9.5L	30T...2T	36T...2T	39T...11T	45T...11T	54T...20T	66T...32T	--
31T...11L	38T...3T	45T...3T	48T...13T	55T...13T	65T...23T	79T...37T	--
37.5T...12.5L	46T...3T	53T...3T	58T...15T	65T...15T	77T...27T	93T...43T	113T...63T 115T...65T 118T...68T
44.5T...14.5L	54T...4T	63T...4T	67T...17T	76T...17T	90T...31T	109T...50T	136T...77T 139T...80T 143T...84T
51T...16L	62T...4T	71T...4T	78T...20T	87T...20T	101T...34T	123T...56T	161T...94T 165T...98T
58T...18L	69T...4T	80T...4T	86T...21T	97T...21T	113T...37T	138T...62T	184T...108T 190T...114T
65T...20L	77T...5T	90T...4T	95T...23T	108T...23T	125T...40T	153T...68T	211T...126T 217T...132T

K7 Housing Bearing	M7 Housing Bearing	N7 Housing Bearing	P7 Housing Bearing
10T...13L	15T...8L	19T...4L	24T...1T
12T...14L	18T...8L	23T...3L	29T...3T
15T...15L	21T...9L	28T...2L	35T...5T
18T...18L	25T...11L	33T...3L	42T...6T
21T...22L	30T...13L	39T...4L	51T...8T
25T...25L	35T...15L	45T...5L	59T...9T
28T...30L	40T...18L	52T...6L	68T...10T
28T...37L	40T...25L	52T...13L	68T...3T
33T...43L	46T...30L	60T...16L	79T...3T
36T...51L	52T...35L	66T...21L	88T...1T
40T...57L	57T...40L	73T...24L	98T...1T
45T...63L	63T...45L	80T...28L	108T...0

Note: Fitting code "L" means the clearance and "t" means the interference.

9. Bearing Clearance

9. Bearing Clearance

The internal clearance of bearing is the measurement by which one ring can be displaced in relation to the other one either in the radial direction or in the axial direction from one end position to the other, and these clearances are specified in the KS B 2102. The internal clearances of bearing are the relative amount of displacement of either inner or outer ring, and they can be divided into two groups, namely axial or radial clearances, depending on their directions, as shown in Table 9-1.

A bearing in operation with an inappropriate internal clearance reduces its life, and generates excessive vibration and heat.

Theoretically, the operating clearances of small minus values allows the life to be extended, but it is practically difficult to achieve such values. In other words, because the internal clearances vary depending on mounting methods, different heat expansion due to temperature gradient, or deformation by loads, etc., it is imperative to precisely

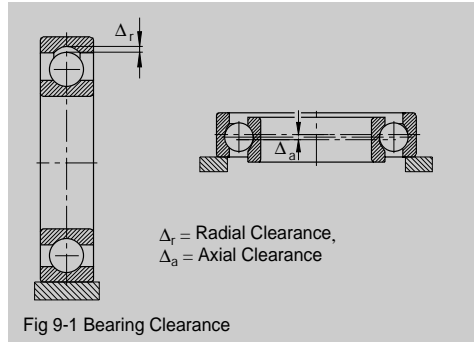

analyze the operating conditions to select appropriate amount of clearance for the bearings.

9-1 Selection of Bearing Internal Clearance

Bearing clearances can be classified into the Normal Clearance Group appropriate for regular operating conditions, smaller Group C2, and larger Groups, C3, C4, and C5. Also, there is a Group CM, which has been specially and empirically created

Table 9-1 Radial Internal Clearance Specifications of Deep Groove Ball Bearings

		Unit : mm															
Nominal Bore Diameter	Over up to	6 10	10 18	18 24	24 30	30 40	40 50	50 65	65 80	80 100	100 120	120 140	140 160	160 180	180 200	200 225	225 250
		Bearing Clearance : μm (0.001mm)															
C2	Min	0	0	0	1	1	1	1	1	2	2	2	2	2	4	4	
	Max	7	9	10	11	11	11	15	15	18	20	23	23	25	30	32	35
CM (For electric motors)	Min	4	4	5	5	9	9	12	12	18	18	24	24	-	-	-	-
	Max	11	11	12	12	17	17	22	22	30	30	38	38	-	-	-	-
Normal Group	Min	2	3	5	5	6	6	8	10	12	15	18	18	20	25	25	30
	Max	13	18	20	20	23	23	28	30	36	41	48	53	61	71	80	90
C3	Min	8	11	13	13	15	18	23	25	30	36	41	46	53	63	74	84
	Max	23	25	28	28	33	36	43	51	58	66	81	91	102	117	134	149
C4	Min	14	18	20	23	28	30	38	46	53	61	71	81	91	107	124	144
	Max	29	33	36	41	46	51	61	71	84	97	114	130	147	163	189	214
C5	Min	20	25	28	30	40	45	55	65	75	90	105	120	135	150	-	-
	Max	37	45	48	53	64	73	90	105	120	140	160	180	200	230	-	-

Table 9-2 Radial Inner Clearance Specifications of Extra Small Bore Deep Groove Ball Bearings (With bore diameters smaller than 10mm)

		Unit : mm					
Clearance Groups		MC1	MC2	MC3	MC4	MC5	MC6
		Bearing Clearance : μm (0.001mm)					
Clearance	Min	0	3	5	8	13	20
	Max	7	8	10	13	20	28

by KBC for motor application that require noise control, and this Group CM has a very small range of radial clearances as well as the small clearance values.

For the miniature bearings, the Clearance Groups of MC1 to MC6 are provided, and the larger the suffix number is, the bigger the clearances are. And MC3 is the Normal Clearance Group for them.

The radial clearance of deep groove ball bearings are shown in Table 9-1 and 9-2.

9-2 Bearing Clearance Variations

A distinction can be drawn between the bearing clearance before mounting and the clearance of mounted bearing under operating temperature (Operating clearance). In order to guide the shaft properly, the operating clearance should be as small as possible.

The clearance of the unmounted bearing gets reduced when mounted due to tight fits of the bearing rings. Furthermore, the radial clearance is also reduced during operation, as inner ring becomes warmer than outer ring, which is usually the case. Therefore, in general, the clearance of unmounted bearing should be larger than the operating clearance.

9-2-1 Reduction of the Radial Clearance by Means of Temperature Differences

$$\Delta_{Grt} = \Delta_t \cdot \alpha \cdot (d+D)/2 \dots\dots\dots \text{(Equation 9-1)}$$

- Where,
- Δ_{Grt} : Reduction of radial clearance [mm]
 - Δ_t : Temperature difference between inner and outer rings [°C]
 - α : Linear thermal expansion coefficient of bearing steel [1/°C]
 - d : Bearing bore diameter [mm]
 - D : Bearing outside diameter [mm]

The radial clearance can vary a great deal, if the bearing is exposed to input or dissipation of heat. A

smaller radial clearance results from heat transfer through the shaft or heat dissipation through the housing. On the other hand, a larger radial clearance results from heat transfer through the housing or heat dissipation through the shaft. Rapid run-up of bearings to operating speed results in greater temperature gradient between the bearing rings than is the case in a steady state. So, either the bearings should be run up slowly or a larger radial clearance than theoretically necessary for the bearings when under operating temperatures should be selected in order to prevent detrimental preload and bearing deformation.

9-2-2 Reduction of Radial Clearance by Means of Tight Fits

Although the radial clearances vary depending on the materials of bearing seat, temperature, or wall thickness, etc., the expansion of the inner ring raceway and the contraction of the outer ring raceway can be assumed to be approximately 80% and 70% of the interference, respectively, provided that solid steel shaft and steel housing with normal wall thickness are used.

Contact KBC for more exact calculations under various conditions, which can be obtained by using KBC's advanced computer software.

$$\Delta_{fit} = (0.7 \sim 0.8) \cdot \Delta_{d,eff} \dots\dots\dots \text{(Equation 9-2)}$$

- Where,
- Δ_{fit} : Reduction of radial clearance [mm]
 - $\Delta_{d,eff}$: Effective interference [mm]

10. Bearing Preload

10. Bearing Preload

Bearing is usually selected to have a small clearance during normal operation, but some bearings are selected to have a negative clearance, when mounted, to generate the internal stress, so that various effects can be achieved.

This is so-called preload method, which can be applied only to the rolling bearings, not sliding ones.

10-1 Purpose of Preload

The objectives and application examples of preloading are shown in the Table 10-1.

10-2 Methods and Characteristics of Preload

There are two main types of preload, namely, a position preload and a constant pressure preload.

Position preload can be further divided into several sub-groups, namely, a method tightly fitting a pair of preloaded bearings, a method adjusting the dimensions of a spacer or seam to obtain the proper preload without using a matched pair of bearings, and a method employing the direct con-

rol of proper degree of fastening force to apply the appropriate amount of preload by measuring the starting friction moment without using spacer or seam.

These kinds of position preload allow a bearing to keep the constant relative position regardless of its operation status.

The constant pressure preload is a method that uses any of coil spring, plate spring, or board spring to apply a proper amount of preload to bearing. Because the rigidity of preload springs is generally and sufficiently smaller than that of bearing, the preloads are kept almost constant although bearing's relative positions vary during operation.

The comparisons between position preload and constant pressure preload are listed below.

- Influence on the increase of bearing rigidity :
Constant pressure preload < Position preload
- Variation of bearing rigidity by bearing load :
Constant pressure preload > Position preload
- Variation of preload by temperature and load :
Constant pressure preload < Position preload

Table 10-1 Preload Purposes and Application Examples

Preload Purpose	Applications
To precisely determine the position of a shaft in radial and axial directions, and to increase its rotating precision at the same time.	Precision bearings for position controlling, used for main shaft bearing of machining tools or precision measuring instruments.
To increase the bearing rigidity	Pinion bearings of main shaft bearing of machining tools or automotive differentials.
To prevent vibration or abnormal noise generated by trembling shaft.	Bearings for small motors of home appliances and others.
To prevent false brinelling	Used where vibration is strong. Bearings for motors required to stop frequently and kingpin thrust ball bearings of automotive vehicles.
To restrict the sliding revolution and sliding rotation of rolling element.	Angular contact ball bearings for high frequency motors or cylindrical roller bearings for jet engines
To restrict the gyration sliding of rolling element	Ball bearings with contact angles or roller bearings of high speed rotation
For exact position control of rolling element against the rings.	For a thrust ball bearing or thrust self-aligning roller bearing used on the side shaft, or to prevent skidding due to ring's own weight load when stopped.

Table 10-2 Methods and Characteristics of Preload

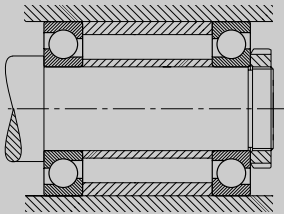
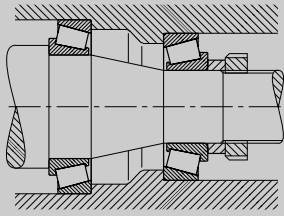
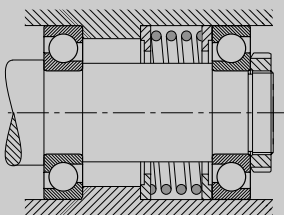
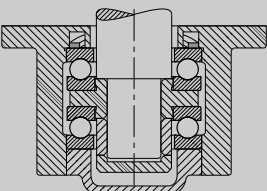
Preloading Method	Example Drawing	Method of Preload Application	Application Examples	Application
Position Preloading		Angular contact ball bearings	ID and OD width variation or a small amount of specified preload is applied.	Grinder Lathe Measuring instrument
		Tapered roller bearings Thrust ball bearings Angular contact ball bearings	The amount of preload is adjusted by controlling the fastening of screws, and the amount of preload is determined by measuring the starting friction torque of a bearing.	Lathe Printer Automotive pinion Automotive wheel
Constant Pressure Preload		Angular contact ball bearings Deep groove ball bearings Tapered roller bearings	Preload is applied by using coil or spring	Motor Winder spindle Grinder
		Thrust ball bearings Thrust spherical roller bearings Thrust cylindrical roller bearings	Preload is applied by using coil or spring	Rolling mill Extruder

10. Bearing Preload

10-3 Preload and Rigidity of Bearing

It is necessary to know the correlations between the applied load and displacement of bearing to find out correlations between preload and rigidity, and to theoretically determine the proper amount of preload.

The correlations between load and displacement, when only axial load is applied to bearing, is easy to analyze, because all rolling elements receive same amount of load. But, when the radial or combined load is applied, it's difficult because of varying load distribution.

Axial displacement against axial load can be calculated as follows.

For ball bearings, the axial displacement, δ_a is

$$\delta_a = \frac{c}{\sin \alpha} (Q^2/D_a)^{1/3} \dots\dots\dots \text{(Equation 10-1)}$$

Where,

- δ_a : Axial displacement [mm]
- c : Constant(Refer to Table 10-3)
- α : Contact angle
- Q : Weight of rolling element [kgf]
- D_a : Ball diameter [mm]

For tapered roller bearings, the axial displacement, δ_a is

$$\delta_a = \frac{0.0006}{\sin \alpha} \cdot \frac{Q^{0.9}}{I_a^{0.8}} \dots\dots\dots \text{(Equation 10-2)}$$

Where,

- I_a : Effective contact length of roller [mm]

Table 10-3 Correlations between f and c

f	0.51	0.515	0.5175	0.52	0.525	0.53	0.54
$c \times 10^5$	176	194	201	207	218	227	242

("f" is the ratio of radius of raceway groove to ball diameter.)

$$Q = \frac{F_a}{Z \sin \alpha} \dots\dots\dots \text{(Equation 10-3)}$$

Where,

- F_a : Axial load [kgf]
- Z : Number of rolling elements

In case of tapered roller bearings, because their contact angles do not change regardless of the axial loads, the same nominal contact angles as determined in the design can be used. But for ball bearings, the following Equation has to be used to obtain effective contact angles, because their contact angles change depending on the axial loads.

$$\frac{\cos \alpha_o}{\cos \alpha} = 1 + \frac{c}{f_o + f_i - 1} (Q/D_a^2)^{2/3} \text{ (Equation 10-4)}$$

In the above Equation, f_o and f_i represent the ratios of raceway radius of outer and inner rings to ball diameter, D_a , and in case of ball bearings, their initial contact angle, α_o , can be obtained by using the inside residual clearance, Δ_r , as follows.

$$\cos \alpha_o = 1 + \frac{\Delta_r}{2(f_o + f_i - 1)D_a} \dots\dots\dots \text{(Equation 10-5)}$$

10-4 Evaluation of Preload

As mentioned earlier, various effects can be achieved by applying the preload appropriately, but application of excessive preload can become the causes for excessive heat generation, increased friction moment, and/or reduction of bearing life, etc.

Therefore the amount of preload should be decided after careful analysis of bearing operating conditions and the purpose of preload, and others.

For example, the main purpose of preload for the bearings of main shaft of machining tools is to increase its rigidity, so the amount of preload can be calculated by using the elastic modulus required for bearing in the shaft system. But, in case of machining tools, RPM range of main shaft is generally very wide, which means that good result can be obtained when heavy cutting job is carried out at low speeds, while the light cutting job at high speeds may generate excessive heat.

Also, in case the main purpose is to prevent false brinelling, the exact amount of preload needs be calculated just enough to prohibit the creation of clearance by vibration load, so as to prevent rolling element from being vibrated by outside vibration when shaft is not rotating.

However, for electric motors, it is essential to review whether the heat generation and shortening of bearing life, caused by preload, has some effect on the performances or system life of the electric motor or not.

Therefore, the appropriate amount of preload should be decided only after comprehensive analysis of theoretically calculated values as well as the empirical/experimental data.

10-5 Controlling of Preload

Various preload control methods are shown below.

- (1) Control by measuring the starting friction moment of bearing

This method uses the starting friction moment, which is measured by using the co-relations between itself and axial load, so as to control the

preload. This method is widely used for tapered roller bearings when they are applied with the preload.

- (2) Control by measuring the spring displacements

This method is used for constant pressure preload. By using the findings of correlations between the load of preload spring and its displacement, preload can be controlled in accordance with the spring displacements.

- (3) Control by measuring the axial displacement of bearing

By using the findings of co-relations between the axial load and axial displacements, preload can be controlled in accordance with its axial displacements.

- (4) Control by measuring the torque (fastening force) of nut

In case that the preload is applied by using the fastening nut on a matched pair of bearings without using a spacer or seam, if the nut has been sufficiently smoothed and fastened by applying sufficiently strong torque, the fastening force, in other word, the preload, can be applied within a comparatively minor fluctuation, which makes it possible to control the preload. This method is widely used for tapered roller bearings in the automotive vehicles.

11. Design of Surrounding Structure

11. Design of Surrounding Structure

11-1 Precision of Shaft and Housing

The recommended IT Tolerance Classes, required to be observed when machining the mating components based on the Tolerance Classes of bearings, are shown in the Table 11-1, and their values in the Appendix.

In the Table 11-1, the tolerances of cylindricity and shoulder of fitting surfaces in axial direction need to be one IT Class higher than that of their diameter. Form tolerances, t_5 and t_6 , to the shaft or housing seating should be determined only after analyzing the alignment of each bearing. At this time, tilting of shaft and housing caused by elasticity modulus should also be taken into account.

To satisfy the cylindricity, t_1 and t_3 , following values are recommended to be met in the measured area(Width of bearing seating).

- Straightness $0.8 \cdot t_1$ or $0.8 \cdot t_3$
- Roundness $0.8 \cdot t_1$ or $0.8 \cdot t_3$
- Parallel $1.6 \cdot t_1$ or $1.6 \cdot t_3$

The bearings with tapered inner diameter are mounted directly on the tapered shaft, or on adapter or withdrawal sleeves. Decision to apply tight fitting should not be made based on the shaft

tolerances, but on the axial insertion magnitude of tapered seating, just like the bearings with cylindrical bore diameter.

The seating tolerances of adapter or withdrawal sleeves could be larger than the diameter tolerances of cylindrical shaft, but form tolerances

Table 11-1 Recommended Machining Tolerance and Roughness of Bearing Seating

Bearing Tolerance Class	Seating	Machining Tolerances	Roughness Class
Normal, P6X	Shaft	IT6 (IT5)	N5...N7
	Housing	IT7 (IT6)	N6...N8
P5	Shaft	IT5	N5...N7
	Housing	IT6	N6...N8
P4, HW	Shaft	IT4	N4...N6
	Housing	IT5	N5...N7
P2	Shaft	IT3	N3...N5
	Housing	IT4	N4...N6

The higher Roughness Class should be applied, when the diameter gets bigger.

Table 11-2 Roughness Classes Based on ISO 1302

Roughness Class	N3	N4	N5	N6	N7	N8	N9	N10
Unit : μm								
Average Roughness Value R_a	0.1	0.2	0.4	0.8	1.6	3.2	6.3	12.5
Depth of Roughness $R_z \approx R_t$	1	1.6	2.5	6.3	10	25	40	63

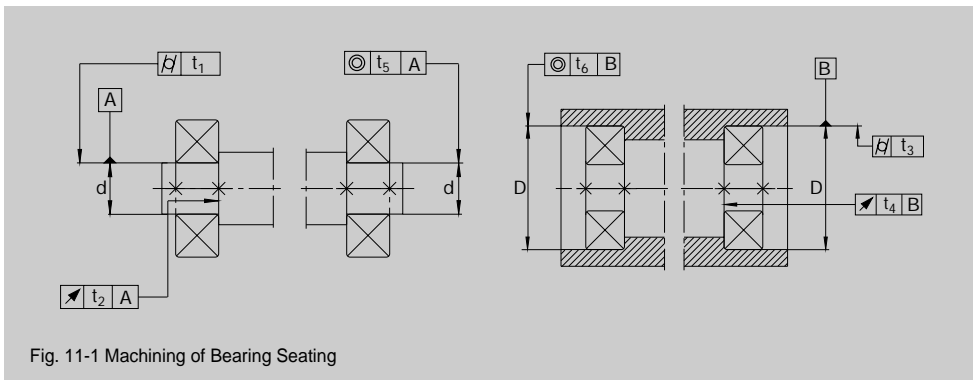

Fig. 11-1 Machining of Bearing Seating

should be smaller than diameter tolerances.

Roughness of bearing seating should be in proportion to its Tolerance Class. The average roughness value, R_a , should not be too large, so that interference reduction may be within its limit.

11-2 Sealing

The seals are used so as to prevent dust, moisture, metal fragments, and other contaminants from entering into bearing, and also to prevent lubricants from being leaked.

The seals have to be able to serve their functions under all operating conditions, and should not produce any abnormal friction, and should not result in any seizure. Also, they have to be easy to mount/dismount and repair/maintain, and also reasonably economical. Therefore, it is necessary to examine the different lubricating methods suitable for each bearing's requirements at the same time when selecting the seals.

11-2-1 Non-Contact Seals

These are the ones that do not come in contact with shaft, and they utilize the centrifugal force or narrow sealing gap to tightly block out inside from outside. These can be applied to the bearings with high speed or under high temperature, because they are free of heat generation, wear and tear of seals, or increase of friction torque.

(1) Narrow Gap Sealing

This is done by having a narrow gap between shaft and housing, and sometimes, they increase the sealing effectiveness by installing several oil grooves of same size in the housing bore.

Also, there is another method of recovering the leaking oil by making the spiral grooves on the shaft outer surface that touches the housing inner surface. When making the grooves, its spiral direction should be decided considering the rotating direction of the shaft.

If it is decided to use the narrow gap sealing method, then it is better to have as narrow gap

between shaft and housing as possible, and the gaps should be between 0.2–0.4mm for bearing shaft diameter smaller than 50mm, and 0.5–1mm for the ones larger than 50mm.

Also, the groove width of 2–3mm is ideal, and the depth of 4–5mm. The number of grooves should be three or more, if no other additional sealing methods are employed.

When a narrow gap sealing method is applied to the oil lubrication, it alone might not be enough to provide sufficient anti-leakage performances, so it is recommended to use it along with other sealing methods. For example, if the grease of worked penetration 200 is applied to the grooves, dust can be blocked out fairly well.

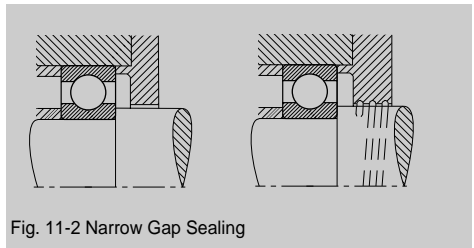

Fig. 11-2 Narrow Gap Sealing

(2) Flinger

This method is to prevent oil leakage or to force out the dusts by utilizing the centrifugal force of a mounted rolling element, flinger, on the shaft.

There are two types of flingers. One is installed inside the housing to prevent the leakage of lubricant by the centrifugal force generated from its rotation, and the other is installed outside the housing to force out the foreign materials, such as dust and water.

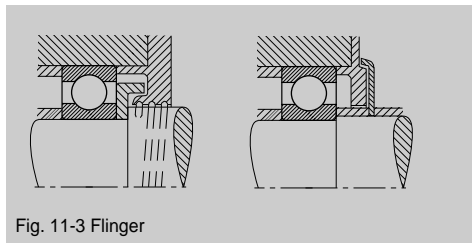

Fig. 11-3 Flinger

11. Design of Surrounding Structure

(3) Labyrinth Seals

This employs the labyrinth shaped seals with narrow gaps to make the passage to outside comparatively longer to increase the sealing effect.

When the gaps are filled with grease, sealing is more effective. And, if the environment is dirty, it is recommended to press grease from the inside into the sealing gaps in shorter time intervals.

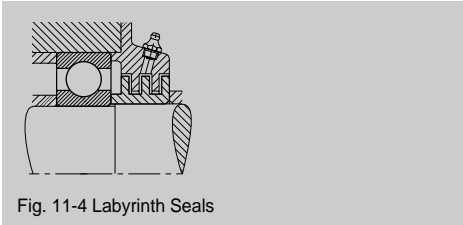

Fig. 11-4 Labyrinth Seals

Table 11-3 Shaft and Gaps of Labyrinth Seals

Nominal Dimension of Shaft (mm)	Labyrinth Gap	
	Radial Direction	Axial Direction
50 up to 50...200	0.25...0.4	1...2
	0.5...1.5	2...5

(4) Lamellar Rings

Lamellar rings made of steel spring disks require some mounting space to both inside and outside of the rings. Lamellar rings can prevent the oil leakage and block out the foreign materials, and they can also serve as a secondary seal when water is often splashed outside bearings.

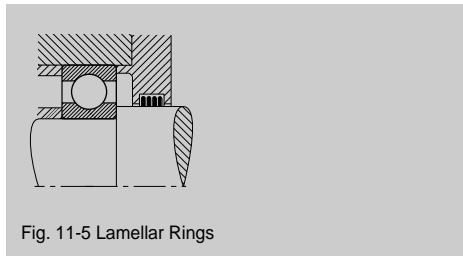

Fig. 11-5 Lamellar Rings

11-2-2 Contact Seals

Contact seals, made of elastic materials, such as synthetic rubber, synthetic resin, or felt, etc., directly rub against the shaft to produce high sealing effect, although there exists a danger of heat generation and increase of rotating torque, due to friction with contact area.

(1) Oil Seals

This is the most commonly used method, and their various sizes and shapes are standardized(KS B 2804).

These seals are usually used, where threat of foreign materials, such as dust and water, etc., being penetrated into is high. And, the eccentricity of shaft can be also corrected, up to a certain degree, by seal lip of synthetic rubber or coil spring in the oil seal.

Because wear and hardening of oil seals varies depending on the circumferential velocities and temperatures of the applied parts, it is important to select a seal of appropriate material. To assist the readers to select the appropriate seals, Table 11-4 shows the permissible speeds and operating temperature ranges for each type of materials.

Table 11-4 Permissible Speeds and Operating Temperature Ranges by Oil Seal Materials

Seal Material	Permissible Speed(m/s)	Operating Temperature(°C)
Synthetic Rubber Nitril-series rubber	Up to 16	-25...+100°C
Acryl-series rubber	Up to 25	-15...+130°C
Silicon-series rubber	Up to 32	-70...+200°C
Fluorine-series rubber	Up to 32	-30...+200°C
PTFE Resin	Up to 15	-50...+200°C

If the circumferential velocity or the inside pressure is high, it is necessary to smoothen the contact surface of the shaft, and also to keep the eccentricity of the shaft less than 0.02 0.05mm.

Table 11-5 Circumferential Velocity of Shaft and Contact Surface Roughness

Circumferential Velocity(m/s)	Surface Roughness	
	R_a	R_{max}
up to 5	0.8a	3.2s
5...10	0.4a	1.6s
over 10	0.2a	0.8s

Also, the shaft surface should have the hardness above $H_{RC} 40$, which can be obtained by applying heat-treatment or plating with hard chrome. The standard values of contact surface roughness required in accordance with circumferential speeds of the shaft are shown in the Table 11-5.

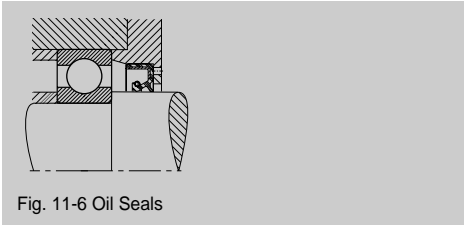

Fig. 11-6 Oil Seals

(2) Felt Rings

Felt rings are simple sealing elements which prove to be particularly successful with grease lubrication. However, they can not provide perfect protection against oil penetration or leaking, so they are usually used, in case of grease lubrication, just for prevention of dust or foreign materials from being entered, and they are generally soaked in oil before mounting for considerably better sealing effect.

If environmental conditions are adverse, two felt rings can be arranged side by side.

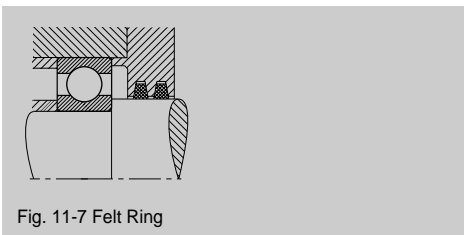

Fig. 11-7 Felt Ring

(3) V-Ring

V-ring is a lip seal with axial effect. During mounting, this one-piece rubber ring is pushed onto the shaft under tension until its lip contacts the housing wall. The sealing lip also acts as a flinger ring.

Axial lip seals are insensitive to radial misalignment and slight shaft inclinations.

With grease lubrication, rotating V-rings are suitable for circumferential velocities of up to 12m/s, stationary ones up to 20m/s. For circumferential velocities over 8m/s, V-rings must be axially supported and for those with 12m/s or more they must also be radially encased. V-rings are frequently used as assisting seals in order to keep dirt away from a radial shaft seal.

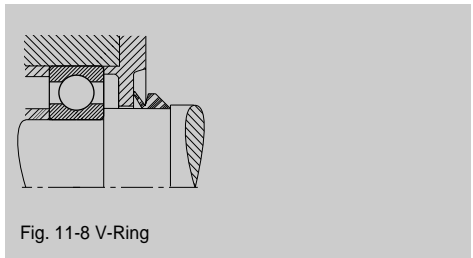

Fig. 11-8 V-Ring

12. Lubrication

12. Lubrication

Lubrication can be defined as the application of some materials between two objects moving relative to each other to allow smooth operation as much as necessary.

Either oil or grease is used for rolling bearings to prevent noise, wear and tear, and heat from being generated from their rolling and sliding movements, and in some special cases, solid lubricants are occasionally used.

The amounts and kinds of lubricants for rolling bearings are determined depending on operation speed, temperature, and surrounding condition, etc. And because the lubricants spent their service-life or polluted with foreign materials can not serve their function well, they have to be periodically replaced or oiled.

12-1 Purpose of Lubrication

Main purposes of lubrication are as follows;

- To prevent wear and premature fatigue by forming the lubrication film on the surface of load transferring parts to prevent contacts between metals.
- To enhance the favorable driving characteristics, such as low noise or friction.
- To prevent overheating of bearings and to prevent lubricant s own deterioration by radiating the generated heat to outside. It works particularly well if the circulation lubrication method is adopted.
- To prevent foreign material penetration, rust, and corrosion.

12-2 Lubrication Methods

For bearing lubrications, either grease or oil is used. It is important to choose the appropriate lubrication method that suits bearing s operating conditions and purpose, for the bearing to perform well.

Oil lubrication is generally better than grease lubrication in many respects, but grease lubrication

is also widely used, because they have merits in that bearings have the available inside spaces for grease and that it is comparatively quite simple to use them.

Table 12-1 Comparisons between Grease and Oil Lubrications

Kinds	Grease Lubrication	Oil Lubrication
Lubrication Effect	Good	Excellent
Cooling Effect	None	Good when circulation lubrication is adopted
Permissible Load	Average load	High load
Speed	Allowable velocity is 60-80% of oil lubrication.	High allowable speed
Sealing and Housing Structure	Simple	Complex
Dust Protection	Easy	Difficult
Leaking of Lubricant	Small	Large
Repairing	Easy	Difficult
Lubricant Replacing	Difficult	Convenient
Torque	Comparatively large	Small
Removing of Foreign Materials	Impossible	Easy
Periodic Inspection	Long	Short

12-3 Grease Lubrication

12-3-1 Lubricating Grease

Grease can be defined as the lubricant of solid or semi-solid state that contains the thickener, and some greases contain various special ingredients. Because various kinds of greases have their own distinct characteristics, and sometimes even the same kind of greases produce quite different performance results, one has to be careful when selecting the greases.

Table 12-2 Types and Performances of Greases

Name	Lithium Grease			Sodium Grease	Calcium Grease	Mixed Grease	Compound Grease	Non-soap Type Grease	
Thickener	Li Soap			Na Soap	Ca Soap	Na+Ca Soap Li+Ca Soap	Ca Compound Soap Al Compound Soap	Urea, Carbon, Black Fluorine Heat-Resistant Organic compound.	
base oil	mineral oil	diester Oil polyol-ester Oil	Silicon Oil	mineral Oil	mineral Oil	mineral Oil	mineral Oil	mineral Oil	Compound grease (Ester Oil, Polyol-ester Oil, Silicon Oil, Combined carbohydrate Oil, Fluorine Oil)
Dropping Point(°C)	170...195	170...195	200...210	170...210	70...90	160...190	180...300	230...	230...
Operating Temperature (°C)	-20...110	-50...130	-50...160	-20...130	-20...60	-20...80	-20...130	-10...130	...220
Permissible Speed Ratio (%)	70	100	60	70	40	70	70	70	40...100
Pressure Resistance	◎	◎	◎	◎	×	◎	◎	◎	◎
Mechanical Stability	△	△	×	○	×	○	○	○	△
Water Resistance	◎	◎	◎	×	◎	one that contains Na is bad	◎	◎	◎
Rust Prevention	◎	◎	×	△	◎	○	○	△	△
Remarks	General Purpose	Excellent low temperature and friction characteristics Suitable	For high temperature Advantageous in high speed and high load	Caution when in contact with water or under high temperature	Excellent Pressure resistance when it contains EP resistance	Used mainly for large bearings	Excellent in pressure resistance and mechanical stability	General purpose	for special purposes such as heat-resistance and acid resistance

Remarks ◎ Excellent ○ Good △ Average × Poor

(1) Base Oil

Base oil in the grease is the main ingredient which actually provides lubricating function, and it forms 80-90% of grease. So, it is important to select the right kind of base oil and its viscosity.

There are two main types of base oil, mineral base oils and compound base oils.

Mineral oils from low to high viscosity are widely

used. Generally, the mineral oils with higher viscosity are used for the locations requiring the lubrications of high load, low speed, and high temperature, and the ones with lower viscosity for the locations requiring the lubrications of low load, low speed, and low temperatures.

Compound base oils are generally very expensive and used for the locations requiring the

12. Lubrication

lubrications of extremely high or low temperatures, or wide temperature ranges, and fast speed and high precision. Compound base oils of mainly ester, poly-olefine, or silicon series are generally used, but the use of fluorine compound oils are increasing nowadays.

(2) Thickener

Thickener is one of the most important elements in deciding the properties of the grease, and the thickness of grease depends on how much thickener is mixed in the grease.

There are mainly three kinds of thickeners, namely, metal soap, non-organic non-soap, and organic non-soap, but the metal soap thickeners are mostly used, and the non-organic non-soap thickeners are generally used only for the special cases, such as operation in high temperature.

Generally speaking, the grease with high dropping point can be used in high temperatures, and the water-resistance of grease depends on that of thickener. Also for the bearings that come in contact with water or are operated under the high humidity level, the Na soap grease or the grease that contains Na soap can not be used, because they deteriorate quickly when in contact with the water or moisture.

(3) Additives

Various kinds of additives are used to enhance the grease performance and to meet the

customers demands for different functions. These additives enhance the physical or chemical properties of grease, and/or minimize the wear, corrosion, or rust to the lubricated metals.

There are various kinds of additives used for prevention of oxidization, wear and tear, or rust. There are also the EP additives. The appropriate grease containing right kind of additives to the applied location has to be used.

(4) Worked Penetration

Worked penetration is used to represent the hardness of grease, and it is shown as the penetrated depth(1/10mm) to grease by the pendulum of specified weight, and the greater the value is, the softer the grease is.

12-3-2 Polymer Grease

Polymer grease of hardened lubricant mixed with polyamid is generally used, and it allows to supply the grease for a long period.

It is widely used for the bearings to which the strong centrifugal force is applied, such as the ones in wire stranding machines or compressors, or to which leaking and pollution to the environment or insufficient lubrication is easy to happen.

12-3-3 Injection of Grease

(1) Injection Amount of Grease

The grease usually occupies 30% of bearing space, initially, and it is distributed evenly during the

Table 12-3 shows the greases of different worked penetrations and their usage.

NLGI Worked Penetration No.	KS Worked Penetrations of Mixtures	State	Usage
0	355...385	Semi-gel or soft	Centralized lubrication system
1	310...340	Soft	Centralized lubrication system
2	265...295	Ordinary	For general use, sealed ball bearings
3	220...250	Ordinary or rather hard	For general use, high temperature use
4	175...205	Rather hard	For special purposes

* NLGI : National Lubricating Grease Institute



Fig. 12-1 Bearings Filled with Polymer Grease

initial few hours of operation. And then, it is operated with just 30–50% of initial friction of the bearing.

The bearings purchased without grease inside, have to be filled with grease by the users themselves, and following cautions have to be taken while filling.

- (a) The space inside the bearing has to be filled completely, but, in case of high speed rotation ($n_{dm} > 500,000 \text{ min}^{-1} \text{ mm}$), only 20–25% of free space has to be filled.
- (b) It is recommended to fill only up to 60% of housing space adjacent to the bearing, so as to leave sufficient room for the dispelled grease from the bearing.
- (c) In case of low speed rotation ($n_{dm} < 50,000 \text{ min}^{-1} \text{ mm}$), whole space of bearing and housing can be filled with grease.
- (d) For the bearings rotating at a very high speed, it is necessary to test-run the bearings in advance, so as to distribute the grease evenly.

(2) Life Span of Grease

The life span of grease is a period from the start of bearing operation to bearing failure due to its insufficient lubricating action.

The life span of a grease with 10% of bearing failure possibility is denoted by F_{10} . The F_{10} Life Span Curves can be obtained by laboratory experiments set up close to the real operation situations. In most cases, because users do not know the values of F_{10} , the lubrication interval, t_p , is reco-

mended as the minimum value for the life span of the standard grease. Refilling interval is set considerably shorter than the lubrication interval, so as to provide stability. Reliability can be increased sufficiently even for the greases barely meeting the minimum requirements, if lubricated in accordance with the lubrication interval curves in the Fig. 12-2.

The lubrication intervals are determined by the values of $k_f \cdot n_{dm}$, which can be obtained from the speed formula related to bearings, and the different values of k_f have been assigned to various kinds of bearings.

The bearings with larger load capacities have larger k_f values, and vice versa. The graph in the Fig. 12-2 shows the lubrication intervals under the conditions of below 70°C measured at the outer ring and $P/C < 1$ for average load.

If either load and/or temperature rise, then the lubrication intervals should be shortened. Furthermore, if the operating and surrounding conditions are not favorable, then they should be even shorter. Also, If the life span of grease is considerably shorter than that of bearing, then it has to be recharged again with grease or the grease has to be totally exchanged. If it is just recharged again with grease, then only a part of whole grease gets to be replaced, therefore, the recharging intervals should be shorter than the lubrication intervals (Generally, between $0.5 \cdot t_f$ and $0.7 \cdot t_f$).

When recharging with grease, different kinds of greases could be mixed together. It is comparatively safe to mix different kinds of greases as follows.

- Greases containing the same thickener
- Lithium grease/calcium grease
- Calcium grease/bentonite grease

12. Lubrication

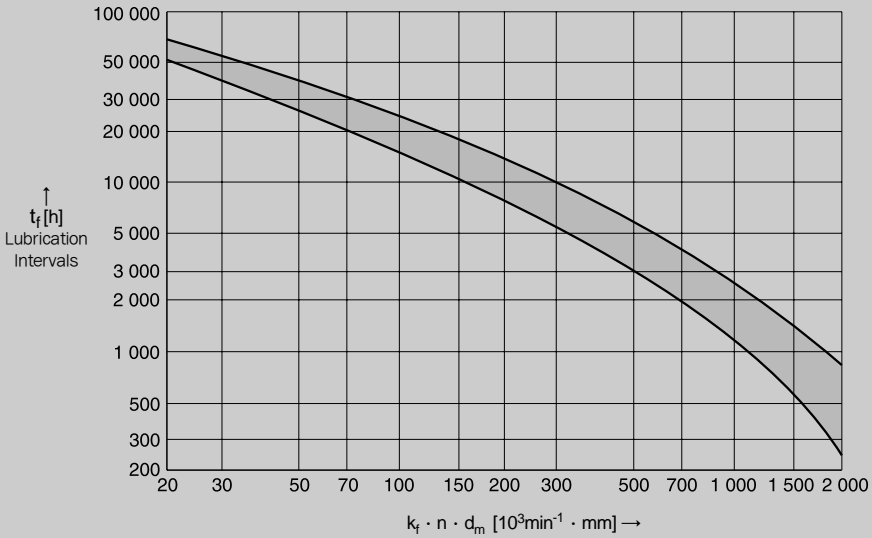

Kinds of Bearings		k_f	Kinds of Bearings		k_f
Deep Groove Ball Bearing	Single row	0.9 ... 1.1	Cylindrical Roller Bearing	Single row	3 ... 3.5 ¹⁾
	Double row			Double row	
Angular Contact Ball Bearing	Single row	1.6		Full complement	25
	Double row		Thrust Cylindrical Roller Bearing	90	
Spindle Bearing	$\alpha = 15^\circ$	0.75	Needle Roller Bearing	3.5	
	$\alpha = 25^\circ$		Tapered Roller Bearing	4	
4-Point Contact Bearing		1.6	Barrel Roller Bearing	10	
Self-Aligning Ball Bearing		1.3 ... 1.6	Lipless Spherical Roller Bearing (E)	7 ... 9	
Thrust Ball Bearing		5 ... 6	Spherical Roller Bearing with Center Lip	9 ... 12	
Thrust Angular Contact Ball Bearing	Double row	1.4			

Note : 1) Bearing applied with radial load and constant axial load ; When axial loads fluctuate, $K_f = 2$.

Remarks 1) Lubrication intervals under fairly good conditions.

2) Grease life span applied to Lithium soap of 10% break possibility under 70°C.

Fig. 12-2 Lubrication Intervals

12-3-4 Properties of Greases

Table 12-4 Grease Property and Application Table-Grease.

Grease	Color	Thickener	Base Oil Viscosity (40°C) mm ² /s	Worked Penetration NLGI	Operating Temperature °C	Limit Rotating Ratio (%)	Main Properties	Main Applications
G6	Light Brown	Lithium soap	ISO VG 90	2	-15...+90	60	Medium speed Heavy load	General industrial Machinery
G9	Brown	Lithium soap	ISO VG 20	2	-55...+130	100	Ultra high speed	Machining tools spinning machine, spindle bearing, small precision bearing
G12	White	Lithium soap	ISO VG 38	2/3	-30...+200	60	Medium speed	OA equipment, electric motor and high temperature use high temperature equipment bearing
G14	Green	Polyurea	ISO VG 110	2	-30...+175	100	Ultra high speed	Coupling, electric equipment(electric motor, generator)
G15	Pale	Lithium soap	ISO VG 28	3	-40...+150	100	High speed	Electric motor precision tools and machinery automotive electrical equipment
G26	Beige	Polyurea	ISO VG 31	2	-40...+160	100	High speed High temperature Long life	Automotive generator, electronic clutch, electric motor
G33	White	Fluorine	ISO VG 400	2	-35...+300	60	Low speed Ultra high temp Special purpose	Chemical equipment, vacuum and semi-conductor equipment, kiln truck
G35	Light green	Polyurea	ISO VG 43	2	-50...+170	100	High speed Wide range temp Chemical resistance Radioactive resistance	Automotive generator automotive electric equipment, household appliances
G42	Beige	Polyurea	ISO VG 95	2	-40...+170	100	High speed Wide range temp	Automotive generator household appliances
G100	Light green	Lithium soap	ISO VG 100	2	-30...+130	70	Standard grease General bearings	Electrical motor, agricultural equipment construction equipment
G101	Pale Yellow	Lithium soap	ISO VG 33	3	-40...+150	100	High speed Wide range temp	Electrical motor Household appliances

12. Lubrication

12-4 Oil Lubrication

12-4-1 Lubricants

Lubricants can be largely divided into two groups, namely mineral oil base lubricants and synthetic lubricants.

When selecting a lubricant, its viscosity is one of the most important factors to be considered. If its viscosity is too low at its operating temperature, oil film can't be sufficiently formed, causing abrasion and/or burning-and-sticking. And, if it's too high, its viscosity resistance becomes higher, causing temperature/friction rise and subsequent abnormal power loss.

In general, lubricants with low viscosity are used when it runs at high speed and low load, and ones with high viscosity when at low speed and high load.

The minimum viscosity at its operating temperature during normal operation is shown at the Table 12-5 shown below, and it should not go under these minimum values.

Lubricants should be selected in accordance with viscosity specified by ISO, and its viscosity index can be used conveniently for references. Although it depends on viscosity indices, its viscosity gets

Table 12-5 Bearing types and minimum dynamic viscosity required for lubricants

Bearing Type	Dynamic viscosity during operation(cSt)
Ball Bearing, Cylindrical roller bearing, Needle roller bearing	over 13
Tapered roller bearing, Cylindrical roller bearing Thrust needle roller bearing	over 20
Thrust spherical roller bearing	over 32

reduced by half whenever the temperature of lubricant increases by 10 °C.

Typical lubricants to be selected depending on bearing's operating condition are shown on Table 12-6.

Table 12-6 Selection of Lubricants

Operating temperature °C	Revolving Speed	ISO Viscosity Class (VG) of Lubricant	
		Light Load or Nomal Load	High Load Impact Load
-30...0	Up to allowable speed	15, 22, 32	46
0...50	up to one half of allowable speed	32, 46, 68	68, 100
	Up to allowable speed	15, 22, 32	32, 46
	Same or above allowable speed	10, 15, 22	-
50...80	up to one half of allowable speed	100, 150, 200	220, 320
	Up to allowable speed	46, 68, 100	100, 150
	Same or above allowable speed	32, 46, 68	-
80...100	up to one half of allowable speed	320, 460	460, 680
	Up to allowable speed	150, 220	220, 320
	Same or above allowable speed	68	-

Remarks: 1) In case of oil sump or circulation lubrication
2) Contact KBC if operating conditions are beyond the values of this Table.

12-4-2 Oil Lubrication Methods

(1) Oil Sump Lubrication

It is the most generally used lubrication method, especially for low or medium speed operations.

Oil surface should be, in principle, placed at the center of lowest rolling element, and it is better to be able to confirm the location of oil surface by using the oil gauge(Fig. 12-3).

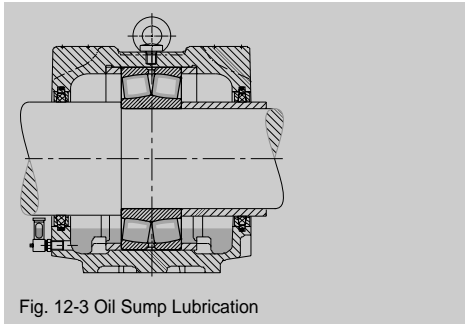

Fig. 12-3 Oil Sump Lubrication

(2) Drip Feed Lubrication

This method is widely used for small bearings that operate at a relatively high speed, and oil supply is controlled by adjusting the volume of oil drip(Fig. 12-4).

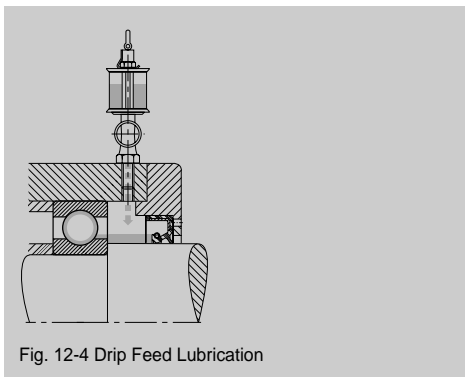

Fig. 12-4 Drip Feed Lubrication

(3) Throwaway Lubrication

This is a method that utilizes gear or circulation ring to supply oil to bearings. It is widely used for automotive transmissions or gears(Fig. 12-5).

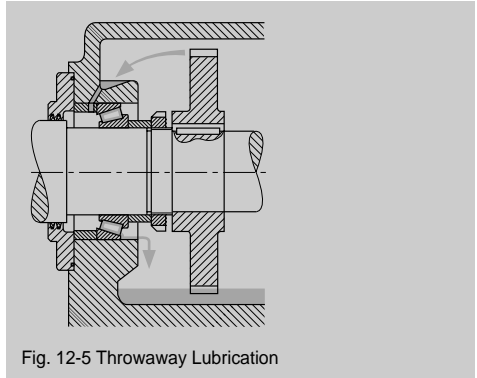

Fig. 12-5 Throwaway Lubrication

(4) Circulation Lubrication

It is widely used when it is necessary to cool the bearing parts that revolve at a high speed, or that with high surrounding temperature. Oil is fed through feed pipe and recovered through recovery pipe, which is cooled down and re-fed again.

The diameter of recovery pipe should be bigger than that of feed pipe, so as to prevent back pressure from occurring to the oil inside a bearing(Fig. 12-6).

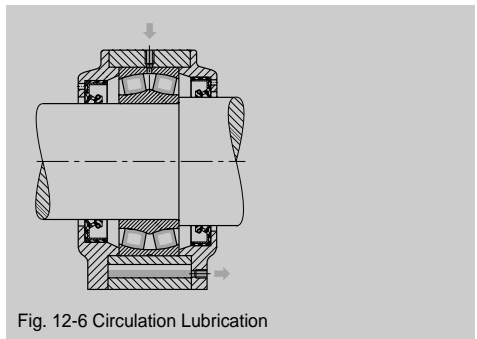

Fig. 12-6 Circulation Lubrication

12. Lubrication

(5) Jet Lubrication

Jet lubrication is widely used for high speed revolution bearings (for $n \leq 1,000,000$), and oil is jet-sprayed through one or several nozzles under constant pressure into the inside of a bearing.

In general, jet stream speed should be faster than $1/5$ of circumferential speed of inner ring outer surface because air wall formed by surrounding air revolving with bearing tends to weaken the jet stream.

Provided that total volume of lubricant is same, the more the number of nozzles are, the smoother and the greater the cooling effect is (Fig. 12-7).

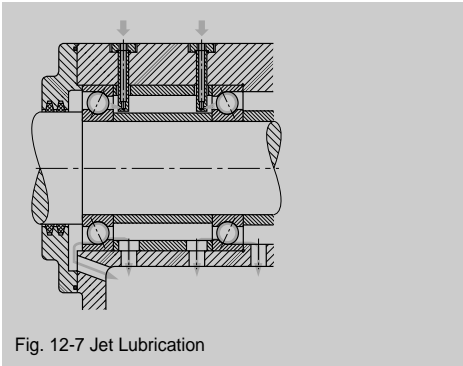

Fig. 12-7 Jet Lubrication

(6) Spray Lubrication

Spray lubrication is a method that vaporizes the lubricant by blowing in the air to be sprayed into bearing. It has following merits.

- Due to small volume of lubricant required, its churning resistance gets smaller, which in return makes it suitable for high speed revolution bearings.
- Because it minimizes volume of discharged lubricant, the pollution to the equipment can be also kept to the minimum.
- Because fresh lubricant is fed all the time, bearing life can be extended.

Therefore, it is widely used for various machining tools, such as high speed spindle, high speed revolution pump, or roll neck bearing of roller (Fig. 12-8).

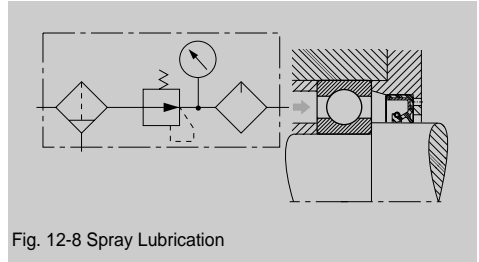

Fig. 12-8 Spray Lubrication

(7) Oil Air Lubrication

Oil air lubrication is a method that forcefully feeds the exactly calculated minimum amount of required lubricant at an optimum interval to each bearing to the end.

Because the minimum amount of fresh lubricant is fed exactly and continuously, lubricant contamination is also kept to the minimum, and air cooling effect is maximized to keep the bearing temperature sufficiently low. Also, pollution to the environment is also kept to the minimum due to the bare minimum amount of lubricant used (Fig. 12-9)

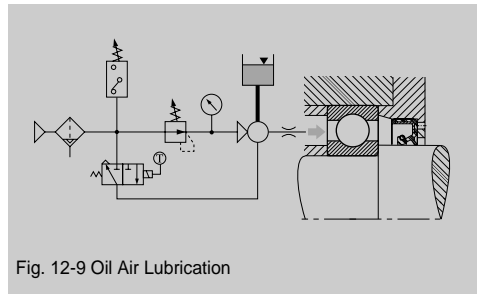

Fig. 12-9 Oil Air Lubrication

13. Bearing Material

13. Bearing Material

Rolling bearing is made of ring and rolling elements, which directly receive the load, and the cage for maintaining rolling elements at a uniform distance.

Ring and rolling elements of bearing receive high contact stress repeatedly, and they involve contact rolling movement along with sliding movement. And cage receives both tensile and compressive forces while having a sliding contact with either ring or rolling element. Bearings, which are used for a long time while continuously and repeatedly receiving high stress, eventually show fatigue effect, and the sliding contact area also becomes slowly worn out, which eventually damage the bearing.

Also, when selecting the bearing material, it is important to consider the stress conditions of each part, as well as lubricating condition, reaction with lubricant, operating temperature and environment, etc.

13-1 Material of Ring and Rolling Element

Both ring and rolling element need to have high mechanical strength, rolling-fatigue resistance, hardness, and wear-resistance.

Furthermore, their material should have excellent dimension stability to prevent performance deterioration caused by dimensional changes. Also, it should have good machinability in consideration of economical production.

Most commonly used materials that satisfy all the above conditions are high carbon chrome bearing steel and case hardened steel, and their chemical composition are shown in Table 13-1 and 13-2.

Kinds of bearing steels depending on the characteristics of used location are shown below.

- General locations
High carbon chrome bearing steel treated with complete hardening process.
- Locations requiring impact load and toughness
High carbon chrome bearing steel treated with surface induction hardening.

Chrome steel, Cr-Mo steel, Ni-Cr-Mo steel treated with carburizing heat treatment.

The probability of rolling fatigue life distribution using same material can vary significantly. This is mainly caused by non-metallic inclusions in the bearing material or segregation and unevenness of other chemical elements.

Non-metallic inclusions affect the characteristics and properties of bearing material in different ways depending on different production procedures in raw materials, melting methods, casting methods, and heat treatments, etc.

KBC makes it a standard procedure to use vacuum degassed raw steel materials, and various data including degree of segregation, and defects, are analyzed and maintained continuously to minimize the deviation. And FHBC also applies special heat(HL) treatment on bearings to even further enhance the resistance of rolling fatigue life.

In general, bearings are made to be used under the operating temperature below 120°C. If used above 120°C, these bearings can post some problems, such as softening or dimension changes of the parts, or insufficient lubrication. To overcome the problems generated during high temperature usage, special measures have been developed to insure the hardness and prevent dimension changes of bearing materials, and these bearings can be safely used under the operating temperatures up to 350°C, provided some operating conditions are met.

Some bearing materials to be used under high temperature or corrosive environment are shown below.

- High operating temperature above 350°C:
Ceramic bearings made of heat resisting steel or Si_3N_4 , etc.
- Heat-resisting or anti-corrosion:
Stainless steel of martensite series.

Also, some special heat treatment processes have been also developed to make it lighter and/or

13. Bearing Material

tougher to overcome the severe operation conditions. By evenly distributing the chemical elements that enhances the surface toughness, cracking propagation caused during lubricating condition such as in the case of foreign materials entered from unclean operating environment can be subdued. And, special heat(RC) treatment which generates fine microstructures, can further increase the rolling fatigue life.

13. Bearing Material

Table 13-1 Chemical Composition of Bearing Steel

Specifications	Symbol	C	Si	Mn	P	S	Cr	Ni	Unit % Mo
KOREA KS D 3525	STB2	0.95...1.1	0.15...0.35	≤0.5	≤0.025	≤0.025	1.3...1.6	≤0.25	≤0.08
	STB3	0.95...1.1	0.4...0.7	0.9-1.15	≤0.025	≤0.025	0.9...1.2	≤0.25	≤0.08
	STB4	0.95...1.1	0.15...0.35	≤0.5	≤0.025	≤0.025	1.3...1.6	≤0.25	1.1...0.25
GERMANY VDEH (German Iron &Steel Association)	105Cr2	1...1.1	0.15...0.35	0.25...0.4	≤0.03	≤0.025	0.4...0.6	-	-
	105Cr4	1...1.1	0.15...0.35	0.25...0.4	≤0.03	≤0.025	1.9...1.15	-	-
	105Cr6	0.9...1.05	0.15...0.35	0.25...0.4	≤0.025	≤0.02	1.4...1.65	-	-
	100CrMn6	0.9-1.05	0.5...0.7	1...1.2	≤0.025	≤0.02	1.4...1.65	-	-
JAPAN JIS G 4805	SUJ1	0.95...1.1	0.15...0.35	≤0.5	≤0.025	≤0.025	0.9...1.2	≤0.25	≤0.08
	SUJ2	0.95...1.1	0.15...0.35	≤0.5	≤0.025	≤0.025	1.3...1.6	≤0.25	≤0.08
	SUJ3	0.95...1.1	0.4...0.7	0.9...1.15	≤0.025	≤0.025	0.9...1.2	≤0.25	≤0.08
	SUJ4	0.95...1.1	0.14...0.35	≤0.5	≤0.025	≤0.025	1.3...1.6	≤0.25	1.1...0.25
	SUJ5	0.95...1.1	0.4...0.7	0.9...1.15	≤0.025	≤0.025	0.9...1.2	≤0.25	1.1...0.25
U.S.A AISI SAE J405	E51100	0.98...1.1	0.2...0.35	0.25...0.45	≤0.025	≤0.025	0.9...1.15	≤0.25	≤0.08
	E52100	0.98...1.1	0.2...0.35	0.25...0.45	≤0.025	≤0.025	1.3...1.6	≤0.25	≤0.08
FRANCE AFNOR	100C2	0.95...1.1	0.15...0.35	0.2...0.4	≤0.03	≤0.025	0.4...0.6	-	-
	100C6	0.95...1.1	0.15...0.35	0.2...0.4	≤0.03	≤0.025	1.35...1.6	≤0.3	≤0.1
	100CD7	0.95...1.05	0.2...0.45	0.2...0.4	≤0.03	≤0.025	1.65...1.95	-	0.15...0.3
GREAT BRITAIN BS970 PART 2	535A99	0.9...1.2	0.1...0.35	0.3-0.75	≤0.05	≤0.05	1...1.6	-	-
SWEDEN SKF	SKF 24	0.92...1.02	0.25...0.4	0.25...0.4	≤0.03	≤0.025	1.65...1.95	-	0.15...0.3
	SKF 25	0.92...1.02	0.25...0.4	0.25...0.4	≤0.03	≤0.025	1.65...1.95	-	1.3...0.4

Table 13-2 Chemical Composition of Surface Hardened Steel

Specifications	Symbol	C	Si	Mn	P	S	Ni	Cr	Mo	Unit %
KOREA	SCR420H	0.17...0.23	0.15...0.35	0.55...0.9	≤0.03	≤0.03	—	0.85...1.25	—	
KS D 3754	SCM415H	0.12...0.18	0.15...0.35	0.55...0.9	≤0.03	≤0.03	—	0.85...1.25	0.15...0.35	
	SCM420H	0.17...0.23	0.15...0.35	0.55...0.9	≤0.03	≤0.03	—	0.85...1.25	0.15...0.35	
	SNCM220H	0.17...0.23	0.15...0.35	0.6...0.95	≤0.03	≤0.03	0.35...0.75	0.35...0.65	0.15...0.3	
	SNCM420H	0.17...0.23	0.15...0.35	0.4...0.7	≤0.03	≤0.03	1.55...2	0.35...0.65	0.15...0.3	
GERMANY	16MnCr5	0.14...0.19	0.15...0.35	1.0...1.3	≤0.035	≤0.035	—	0.8...1	—	
DIN	20MnCr5	0.17...0.22	0.15...0.35	1.1...1.4	≤0.035	≤0.035	—	1...1.3	—	
17210	15CrNi6	0.12...0.17	0.15...0.35	0.4...0.6	≤0.035	≤0.035	1.4...1.7	1.4...1.7	—	
	18CrNi8	0.15...0.2	0.15...0.35	0.4...0.6	≤0.035	≤0.035	1.8...2.1	1.8...2.1	—	
JAPAN	SCR420H	0.17...0.23	0.15...0.35	0.55...0.9	≤0.03	≤0.03	—	0.85...1.25	—	
JISG	SCM415H	0.12...0.18	0.15...0.35	0.55...0.9	≤0.03	≤0.03	—	0.85...1.25	0.15...0.35	
4052	SCM420H	0.17...0.23	0.15...0.35	0.55...0.9	≤0.03	≤0.03	—	0.85...1.25	0.15...0.35	
	SNCM220H	0.17...0.23	0.15...0.35	0.6...0.95	≤0.03	≤0.03	0.35...0.75	0.35...0.65	0.15...0.3	
	SNCM420H	0.17...0.23	0.15...0.35	0.4...0.7	≤0.03	≤0.03	1.55...2	0.35...0.65	0.15...0.3	
U.S.A. ASTM A 304	5120H	0.17...0.23	0.15...0.3	0.6...1	≤0.025	≤0.025	—	0.60...1	—	
	4118H	0.17...0.23	0.15...0.3	0.6...1	≤0.025	≤0.025	—	0.3...0.7	0.08...0.15	
	8620H	0.17...0.23	0.15...0.3	0.6...0.95	≤0.025	≤0.025	0.35...0.75	0.35...0.65	0.15...0.25	
	4320H	0.17...0.23	0.15...0.3	0.4...0.7	≤0.025	≤0.025	1.55...2	0.35...0.65	0.2...0.3	
FRANCE AFNOR	20ND8	0.16...0.23	0.1...0.35	0.2...0.5	≤0.03	≤0.025	1.8...2.3	—	0.15...0.3	
	16MC5	0.14...0.19	0.1...0.4	1...1.3	≤0.03	≤0.025	—	0.8...1	—	
	20NCD2	0.18...0.23	0.1...0.4	0.7...0.9	≤0.03	≤0.025	0.4...0.7	0.4...0.6	0.15...0.3	
	16NCD4	0.12...0.19	0.1...0.4	0.5...0.9	≤0.03	≤0.025	1...1.3	0.4...0.7	0.1...0.2	
	16NCD13	0.12...0.18	0.1...0.4	0.2...0.5	≤0.03	≤0.025	3...3.5	0.85...1.15	0.15...0.35	
	18NCD4	0.16...0.22	0.2...0.35	0.5...0.8	≤0.03	≤0.025	0.9...1.2	0.35...0.55	0.15...0.3	
	20NCD7	0.16...0.22	0.2...0.35	0.45...0.65	≤0.03	≤0.025	1.65...2	0.2...0.6	0.2...0.3	
GREAT BRITAIN BS970 PART 3	665H17	0.14...0.2	0.1...0.35	0.3...0.6	≤0.05	≤0.05	1.5...2	—	0.2...0.3	
	655H13	0.1...0.16	0.1...0.35	0.3...0.6	≤0.05	≤0.05	3...3.75	0.6...1.1	—	
	832H13	0.1...0.16	0.1...0.35	0.3...0.6	≤0.05	≤0.05	3...3.75	0.6...1.1	0.1...0.25	
	820H17	0.14...0.2	0.1...0.35	0.6...0.9	≤0.05	≤0.05	1.5...2	0.8...1.2	0.1...0.2	
	805H20	0.18...0.23	0.15...0.35	0.7...1	≤0.05	≤0.05	0.4...0.7	0.55...0.8	0.15...0.25	

13. Bearing Material

13-2 Cage Material

Cage guides rolling elements between the rings, and keeps rolling elements at equal distances, so as to minimize the friction between rolling elements.

So it is essential for cage to have appropriate hardness and abrasive-resistance as well as deformation-resistance against adverse impact.

Although the applied load to cages could be considered to be a lot smaller than those to rolling elements or rings, they comparatively have more chances for sliding contacts, which needs to be considered.

Cages can be divided into two groups, namely, metal(ferrous and non-ferrous) cages and synthetic resin cages. Metal cages can be further divided into press cages and machined cages.

And there are many kinds of cages for different kinds, sizes, revolving speeds, temperature conditions, lubricating methods, machining workability of various bearings.

Cold strip steel sheets, such as shown on Table 13-3, are mainly used for ferrous cages, and they are generally press fabricated and used for most of deep groove ball bearings, cylindrical roller bearings, and tapered roller bearings. In case of general use, they do not usually pose any problems at all even under the temperatures higher than 250 °C. For larger bearings, some machine-tooled ferrous cages are sometimes used.

On the other hand, non-ferrous cages are mostly

made of high-tensile brass and they are usually machine-tooled.

Metal cages are sometimes processed(SL Treatment) for efficient lubrication and high heat-resistance, when required for special use. And, to make efficient lubrication even better, which helps to improve torque and noise-level even further, special solid lubrication thin film is sometimes applied. And, in these days, the quantity of KBC production of light, self-lubricating, synthetic resin cages are increasing more and more.

Glass-fiber reinforced, polyamide is widely used for cage material, because it has an excellent lubricating property, reducing friction between rolling elements and rings, and it is also light, making it easy to obtain high revolving speed. Also, it produces almost no wear debris, which helps, in case of grease lubrication, to increase the grease life span.

And its excellent workability makes it an excellent choice for complex shaped cages made to suit the special bearings. However, its heat resistance quality is not that good, although it poses no problem up to general operating temperature of 120°C.

Sometimes, multi-layer penol resin is used as cage material, and this is usually made of fabric layers on penol resin base. Because of its ability to absorb lubricant, heightening lubrication quality drastically, it is widely used for bearings with ultra high revolving speed.

Table 13-3 Chemical Composition of Cage Materials(Cold Strip Steel Sheet)

Standards	Codes	C	Si	Mn	P	Unit % S
KOREA KS D 3512	SCP1	≤0.1	≤0.04	0.25...0.45	≤0.03	≤0.03
	SCP2	0.13...0.2	≤0.04	0.25...0.5	≤0.03	≤0.03
	SCP3	0.45...0.55	0.15...0.35	0.40...0.85	≤0.03	≤0.03
JAPAN BAS 361	SPB1	≤0.1	≤0.04	0.25...0.45	≤0.03	≤0.03
	SPB2	0.13...0.2	≤0.04	0.25...0.5	≤0.03	≤0.03
	SPB3	0.45...0.55	0.15...0.35	0.4...0.85	≤0.03	≤0.03
U.S.A SAE J403g J118 J403g	1008	≤0.1	≤0.1	0.3...0.5	≤0.04	≤0.05
	1009	≤0.15	≤0.1	≤0.6	≤0.04	≤0.05
	1010	0.08...0.13	≤0.1	0.3...0.6	≤0.04	≤0.05

14. Handling of Bearings

14. Handling of Bearings

Bearings are heavy-duty machine elements with high precision, so care has to be taken for them to serve their functions to the fullest degree.

To last up to their life span, following points especially have to be observed.

- (1) Always keep bearings and working environment clean and tidy.

When a bearing is mounted on shaft and housing while working environment is polluted with dust or other foreign particles, or while bearing itself is dirty due to unclean storage, dust or minute foreign particles can induce indentation or scratches on bearing rolling element surface, resulting in fatigue rupture at the time below rated fatigue life.

Therefore surrounding working environment needs to be kept clean and tidy all the time, and also tools and hands need to be clean and dry while working on bearings.

Also, spare bearings need to be stored in well-ventilated, dry space, and they need to be checked for appropriateness before mounting.

- (2) Handle the Bearings with care.

Sudden impacts to or dropping of a bearing while handling them, or mounting of a bearing with excessive force while using hammer or others, can cause indentation or scratches on bearing rolling element surfaces, resulting in its early rupture.

Care has to be taken while handling the bearings, because abnormal or excessive damage to bearing rolling element surface can induce breakage of rings or separation of rings of non-separable type bearings.

- (3) Use only clean lubricants and greases.

When dismounting and checking the bearings for abnormality, surroundings around housing should be cleaned first before dismounting starts, and then after dismounting, foreign materials on and around outside and inner surface of bearing and others should be wiped off thoroughly by using dry cloth.

In case of open type bearings, it is recommended to clean them with kerosene oil or equivalents before re-mounting them.

Also, only clean lubricants or greases not contaminated with dust or any other solid foreign materials should be used.

- (4) Be sure to prevent bearing corrosion from developing

When bearing comes in contact with hand sweat, water-soluble lubricants or cleansers, rust can be developed later on.

Therefore when it is necessary to work on a bearing with bare hands, hands should be washed thoroughly first to get rid of sweat and then high-quality mineral oil should be applied to hands before working on a bearing.

Specially during rainy seasons or summer, care should be taken to prevent corrosion.

- (5) Use appropriate tools.

Use of inappropriate tools, which just happen to be around, for example, while working on bearings, should be avoided at all cost. Use only appropriate tools suitable for the tasks involved.

Also, when using the cloth for cleaning, one needs to make it sure it's not a kind that produces shag, which contaminate a bearing.

14-1 Storage Precautions

Preservation medium and packaging of KBC bearings are designed to retain the bearing properties as long as possible.

Certain requirements must, therefore, be met for storage and handling. During storage, the bearings must not be exposed to the effects of aggressive media such as gases, mists or aerosols of acids, alkaline solutions or salts. Direct sunlight should also be avoided because it can cause large temperature variations in the package, apart from the harmful effects of UV radiation. The formation of condensation water is avoided under the following conditions.

14. Handling of Bearings

- Temperature range : 6~25°C (30°C for short period)
- Max. temperature difference, day/night: 8K
- Max. relative air humidity: 65%
- Location should be free of excessive vibration.

With standard preservation, bearings can be stored safely up to 5 years, if the said conditions are met. If this is not the case, shorter storage periods must be taken into consideration.

If the permissible storage period is exceeded, it is recommended to check the bearing for its preservation state and corrosion prior to use. In case of sealed type bearings filled with grease, their permissible storage periods tend to be shorter, because the lubricating grease contained in the bearings may change their chemico-physical behavior due to aging.

Bearings completed inspection or ones with damaged packages contaminating the inside, should be washed by using appropriate washing oil. While washing with oil, turn either inner or outer ring little by little.

Ones with seal or shield on one side should be handled same as open type bearings. And the others with them on both sides should not be washed at all, but, instead, anti-corrosion agent should be applied thinly prior to use, or they should be wrapped with oil paper before being stored.

14-2 Mounting of Bearings

The shop drawings should be studied prior to mounting to become familiar with the design. The order of the individual work steps is schematically laid down including the required heating temperatures, mounting forces and grease quantities. The anti-corrosion agent of the packed KBC bearing has no effect on the standard greases which are most commonly used (Lithium soap mineral grease), and does not have to be washed off prior to mounting. It is only wiped off the seats and mating surfaces.

When anti-corrosion agent is washed off from KBC bearings, rust can be developed easily, so

they should not be stored for long before being used.

Rolling bearings must be protected from dirt and humidity under all circumstances so as to avoid damage to the running areas. The work area must, therefore, be clean and free of dust.

When mounting the bearings, loads of rings and rolling elements should not be applied to them, and mounting forces should be applied uniformly to all points around rings. Blows with the hammer applied directly to the bearings, which can damage them, should be avoided completely.

14-2-1 Mounting of Tapered Bore Bearings

In the case of mounting the non-separable bearings by using press or hammer, the mounting forces are applied to the ring which is to have a tight fit by using an unrelieved mounting disk on ring's to be mounted, or by using mounting disk that touches both outer and inner rings, as shown in Fig. 14-1.

However, in bearings where the cage or balls project laterally (e. g. Some self-aligning ball bearings), a relieved disk should be used so as not to damage cage or balls during mounting, as shown on Fig 14-2. But, separable bearings can be mounted independently.

Bearings with a maximum bore of approximately 80 mm can be mounted cold. The use of mechanical or hydraulic press is recommended.

Should no press be available, the bearing can be driven on with hammer and mounting sleeve. Bearings with a cylindrical bore for which tight fits on a shaft are specified and which cannot be pressed mechanically onto the shaft without great effort, are heated before mounting. Fig. 14-3 shows the heat-up temperatures required for easy mounting as a function of the bearings bore d .

The data applies to the maximum interference, a room temperature of 20°C plus 30 K to be on the safe side. At this time, bearings should be heated up higher than 120°C.

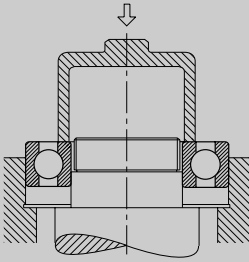

Fig. 14-1 Pressing of a Bearing when Tight-Fitting a Inner Ring

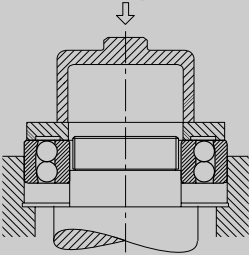

Fig. 14-2 Simultaneous Pushing In of Both Inner and Outer Rings

Induction heating devices are particularly suitable for fast, safe and clean heating, and the device should be selected considering the size and weight of a bearing.

Individual bearings can be heated provisionally on an electric heating plate, and the bearing can be covered with a metal sheet and turned several times.

A safe and clean method of heating bearings is to use a thermostatically controlled hot air or heating cabinet.

It is used mainly for small and medium-sized bearings, but the heat-up times are relatively long.

Bearing of all sizes and types can be heated in an oil bath except for sealed and greased bearings as well as precision bearings.

A thermostat control is advisable (Temperature 80 to 100°C). The bearings are placed on a grate or hung up for them to heat uniformly. This method has some disadvantages, such as accident hazard, pollution of the environment by oil vapours, inflammability of hot oil, danger of bearing contamination.

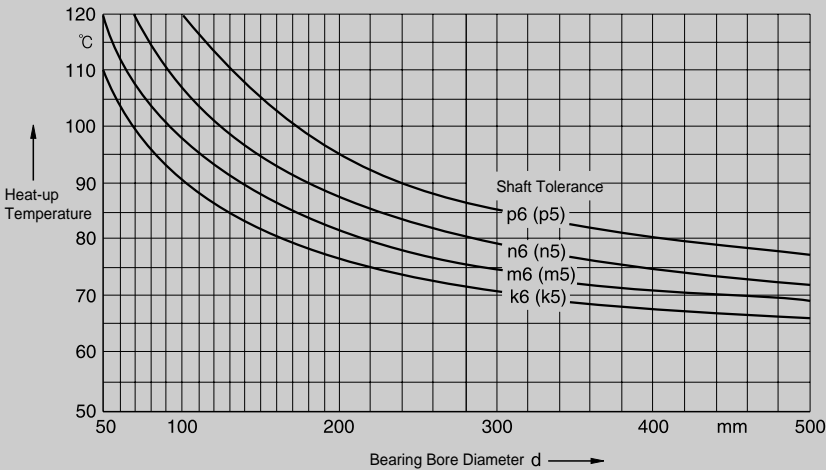

Fig. 14-3 Diagram for Determining the Heat-up Temperature

14. Handling of Bearings

14-2-2 Mounting of Tapered Bore Bearings

Rolling bearings with a tapered bore are either fitted directly onto the tapered shaft seat or onto a cylindrical shaft with an adapter sleeve or a withdrawal sleeve(Refer to Fig. 14-4, 14-5, 14-6).

In general, tapered bore bearings require tight fits whose interference is a little bigger than that of cylindrical bore bearings. The bigger the applied load is, the stronger tight fit is required.

And this makes inner ring expand, and which, in return, makes bearing's inner clearance smaller. Therefore, the inner clearance of a tapered roller bearing prior to mounting should be bigger than that of a cylindrical bore bearing. The resulting tight fit of the inner ring is measured by checking the radial clearance reduction due to the expansion of the inner ring or by measuring the axial drive-up distance.

Small bearings(up to approx. 80mm bore) can be pressed with a locknut onto the tapered seat of the shaft or the adapter sleeve. A hook spanner is used to tighten the nut.

Small withdrawal sleeves are also pressed with a locknut into the gap between the shaft and inner ring bore.

Considerable forces are required to tighten the nut with medium-sized bearings. Locknuts with thrust bolts facilitate mounting in such cases.

It is advisable to use a hydraulic press for driving up larger bearings or pressing them onto the sleeve.

Hydraulic nuts are available for all popular sleeve and shaft threads. For bearings with a bore of approximately 160mm and upwards mounting and especially dismounting are greatly facilitated by the hydraulic method.

An oil with a viscosity of about $75\text{mm}^2/\text{s}$ at 20°C (Nominal viscosity at 40°C : $32\text{mm}^2/\text{s}$) is recommended for mounting.

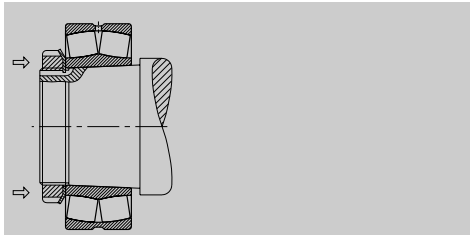

Fig. 14-4 Direct Mounting on a Tapered Shaft

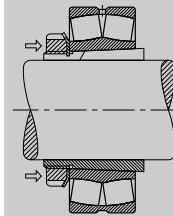

Fig. 14-5 Mounting on an Adapter Sleeve

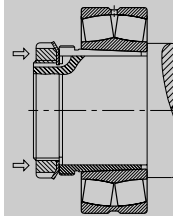

Fig. 14-6 Mounting on a Withdrawal Sleeve

14-3 Bearing Performance Test

14-3-1 Manual Operation Test

Small bearings can be turned around manually, and for large bearings, power is turned on momentarily without applying any load at all, then turned off, and then their performance is checked whether they run smoothly.

Followings and others need to be checked; Excessive torque or noise or vibration, or interfere-

nce in the revolving parts, caused by imbalance revolution torque caused by inserted foreign materials or dust, groove or indentation mark, or improper mounting, inappropriate amount of clearance, or seal friction.

14-3-2 Operation Test with Power On

If no abnormality is found during manual test, then the bearing's performance is tested again with power on.

The test is carried on by starting the machine in low speed without applying any load, and then accelerating it in accordance with specified

condition until rated operation is achieved. Its performance is checked during whole operation for noise, abnormal sound, bearing temperature variation, temperature rise due to friction, color changes and leakage of lubricant, etc.

It's possible to directly measure the temperature of bearing outer ring through oil hole, but, in general, it is estimated by measuring the temperature of housing's outer surface. Bearing temperature rises as running time passes, but after certain time, it reaches constant normal running temperature. But, if there exists some bearing mounting error, excessive inner clearance, or excessive friction in sealing device, etc., then temperature rises rapidly, which calls for inspection.

14-4 Dismounting of Bearings

When it is required to inspect or replace the bearings, the mounted bearings have to be dismounted first.

Dismounting of bearings require careful handling just like its mounting, and bearings need to be designed from the beginning with dismounting safety and convenience in mind, so as not to damage the bearing, shaft, housing, or any other surrounding parts during dismounting, and proper dismounting tools should also be provided.

If the bearings are to be used again, the extraction force should be applied only to the tightly fitted bearing ring with interference.

14-4-1 Dismounting of Cylindrical Bore Bearings

It is efficient enough to use, in case of small bearings, a rubber hammer, or an extracting tools as shown on Fig. 14-7 or 14-8, or a press as shown on Fig. 14-9. And with non-separable bearings, such as deep groove ball bearings, if the inner ring is tightly fitted, then care should be taken to apply all extraction forces only to the inner ring.

When extraction tools are used to dismount the bearings, inner ring supporting parts of them should be sufficiently fixed onto the side of inner ring. This is why the size of shaft lip dimension as well as the location of groove for holding extraction tool have to be considered from the initial design stage.

When a tightly-fitted large bearing is mounted onto the shaft, large extraction force is required. In this case, oil injection method, which utilizes oil pressure on the tightly fitted surface, is widely used. This method works because inner ring gets expanded as wide as the thickness of oil film formed by forced injection, which makes bearing dismounting that much easier.

In case of dismounting cylindrical roller bearings of NU or NJ types, or others, which has no lip, or just one integral lip, the induction heating device that rapidly heats up and expands the inner ring locally is used.

When dismounting non-separable bearings, a loosely fitted side should be separated first, and then the tightly fitted side is dismounted. And when dismounting separable bearings, inner and outer rings can get dismounted independent of each other.

14. Handling of Bearings

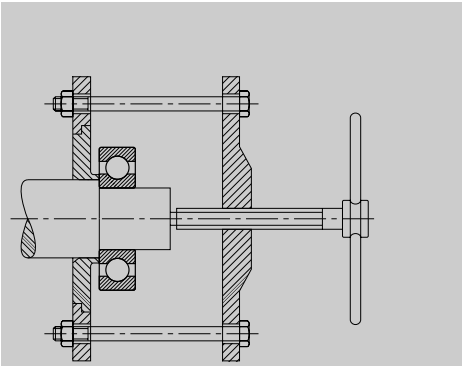

Fig. 14-7 Dismounting of Ball Bearing by using a Extraction Tool

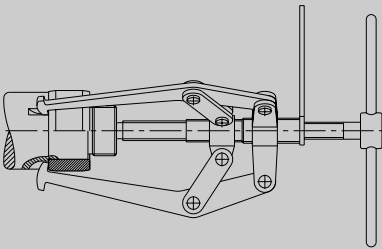

Fig. 14-8 Dismounting of Inner Ring of Cylindrical Roller Bearing by using a Extraction Tool

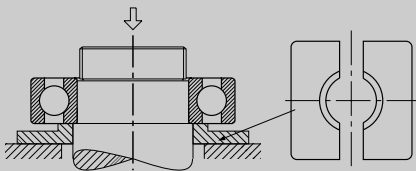

Fig. 14-9 Dismounting of Inner Ring by using Hydraulic Press

14-4-2 Dismounting of Tapered Bore Bearings

When the bearings are directly on the tapered seat or an adapter sleeve, the lock nut is loosened first, and then mounting disk is placed before it is driven off by means of a hammer(Refer to Fig. 14-10, 14-11).

Withdrawal sleeve mounted bearings are removed by means of the extraction nut. If difficulty is expected to remove them, bolt holes may be drilled in advance on the circumference, so that bearing can be removed by fastening the bolts(Refer to Fig. 14-12).

The hydraulic nut is applied to facilitate the dismounting of large-size bearings(Refer to Fig. 14-13)

In case that oil grooves and supply holes have been drilled on tapered shaft in advance, or that the sleeve with oil groove and supply hole is used, bearings can be easily removed without damaging the surfaces by using the oil pump, because forcefully injected protects the rubbing surfaces.(Refer to Fig. 14-4, 14-5). However, since the press fit is released abruptly, a stop such as a nut should be provided to control the movement of the bearing.

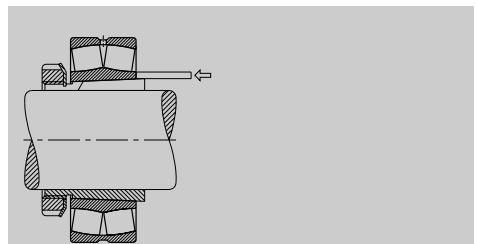

Fig. 14-10 Dismounting of Adapter Sleeve by using Metal Drift

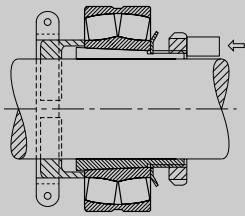

Fig. 14-11 Dismounting of Adapter Sleeve by using Stop Nuts

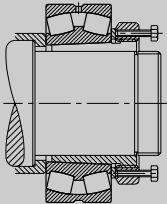

Fig. 14-12 Dismounting of Withdrawal Sleeve by using Bolts

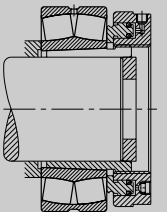

Fig. 14-13 Dismounting of Withdrawal Sleeve by using Hydraulic Nuts

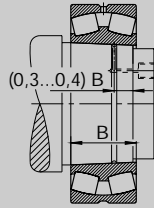

Fig. 14-14 Dismounting of Tapered Shaft by using Hydraulic Pressure

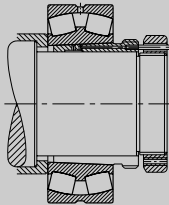

Fig. 14-15 Dismounting of Withdrawal Sleeve by using Hydraulic Pressure

14. Handling of Bearings

14-4-3 Dismounting of Outer Rings

Two methods are widely used to dismount a tightly-fitted bearing outer rings.

First, one can drill several holes for outer ring extraction bolts on the circumference of bearing housing in advance, so as to fasten the bolts uniformly to dismount a ring, as shown on Fig. 14-16. Second, one can make some grooves for dismounting metal piece on the housing lip, and then use hydraulic press or hammer to dismount the ring, as shown on Fig. 14-17.

The other method of cold extraction effect by using dry ice or liquified nitrogen gas is quite efficient in that it requires light extraction force and extraction can be done easily.

However its extraction cost is comparatively

expensive than other methods, so this method is employed only in some special cases.

14-5 Compression and Extraction Forces

Amount of compression or extraction forces required to be applied to tightly fit or extract the bearings by giving the interferences is calculated as follows.

$$F_p = \mu \cdot P_m \cdot \pi \cdot d(\text{or } D) \cdot B \dots\dots\dots (\text{Equation 14-1})$$

Where,

- F_p : Compression or extraction force [N]
- P_m : Pressure on tightly fitted surface [N/mm²]
- d : Bearing bore diameter [mm]
- D : Bearing outer diameter [mm]
- B : Width of inner or outer ring [mm]
- μ : Sliding friction coefficient

Actual forces required to mount or dismount bearings on the job are much bigger than the figures theoretically obtained by using above equation.

Therefore, the above equation should be used just as a reference, and mounting or dismounting tools should be designed to withstand much stronger forces.

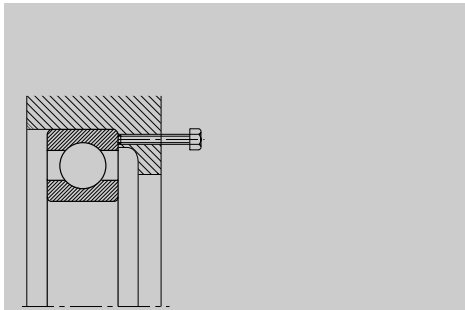

Fig. 14-16 Dismounting of Outer Ring by using Dismounting Bolt

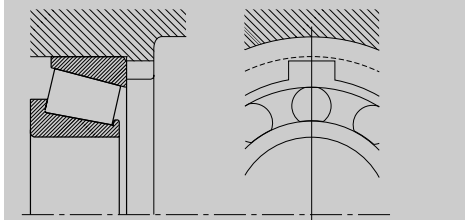

Fig. 14-17 Dismounting Groove

Condition	Coefficient(μ)
When mounting inner ring on cylinder shaft	0.12
When dismounting inner ring from cylinder shaft	0.18
When mounting inner ring on tapered shaft or sleeve	0.165
When dismounting inner ring from tapered shaft	0.135
When mounting sleeve on shaft or bearing	0.3
When dismounting sleeve from shaft or bearing	0.33

15. Damage to Bearings and Preventive Measures

15. Damage to Bearings and Preventive Measures

When bearings are used normally and rightfully, they usually can run longer than their theoretical fatigue lives. If that's not the case, bearings can be easily damaged before its life span. It is necessary to find out the exact causes for abnormal damages to a bearing, but it is quite difficult to determine the causes just by examining the damages to the bearing.

Therefore, following points including damaged shape of a bearing have to be analyzed comprehensively to construct the causes, and their appropriate measures to prevent early damages from recurring; operating conditions, surrounding structure, status before and after the damage to the bearing, etc.

Presumed causes depending on the times of

damage to a bearing are shown on Table 15-1, and typical shape of bearing damages, and their causes and preventive measures are shown on Table 15-2.

Table 15-1 Occurring Time and Causes for Abnormal Bearing Damages

Occurring Time of Damage	Improper Selection of Bearing	Faulty Design or Fabrication of Surrounding Parts (Shaft, Housing, etc.)	Improper Mounting of Bearing	Improper Lubricant, Lubricating Method or Amount	Improper Seal Intrusion of Moisture or Other Foreign Particles	Bearing Defect
Immediately after mounting or during initial operation period	●	●	●	●		●
Immediately after bearing dismounting and re-mounting			●	●	●	
Immediately after supplying lubricant				●	●	
Immediately after repairing or replacing shaft, housing, etc.		●	●		●	
Some time after operation begins	●	●	●	●	●	●

Table 15-2 Typical Shape of Bearing Damages, and Their Causes and Preventive Measures

Damaged Shape		Causes	Preventive Measures
Flaking (Fig. 15-1,2)	All through circumference at the center of radial bearing raceway.	Narrow clearance	Examine the amount of tight fit interference. Examine the bearing clearance.
	Symmetrically on the circumference of radial bearing raceway.	Poor roundness of shaft or housing Poor precision of divided housing	Re-fabrication or re-production of shaft or housing
	Inclined against circumference of radial bearing raceway. On the raceway of roller bearing and on edges of rolling elements	Improper mounting Bent shaft Eccentricity	Increase shaft rigidity Correction of shaft or housing lip angle to be perpendicular Proper mounting
	Just on parts of inner or outer ring raceway circumference	Excessive load	Replace with larger bearing with larger load capacity
	On raceway in interval of a rolling element	Heavy impact during mounting Corrosion during non-operation period	Proper mounting Measures to prevent corrosion during non-operation period
	Only on one side of radial bearing raceway	Abnormal axial load	Securing of free end considering thermal expansion of shaft
	Early occurrence on combination bearing	Excessive preload	Adjust preload
Scratches (Fig. 15-3,4)	Occurrence on raceway	Insufficient lubricant Grease is too light When starting, too fast acceleration	Insufficient lubricant Grease is too light When starting, too fast acceleration
	Spiral marks on thrust ball bearing raceway	Raceway is not parallel Too fast acceleration	Mount the bearing carefully and precisely Apply an appropriate amount of preload Re-select the bearing
	Marks on roller face and shoulder lip	Poor lubrication Excessive axial load	Re-examine the lubricant and lubricating method Re-select the bearing Take the preventive measures against thermal expansion
Crack(Fig. 15-5)	Cracks on inner or outer ring	Excessive impact load Excessive interferences Progress from flaking	Take the preventive measures against impact load Mount the bearing carefully and precisely Re-examine the tight-fit interferences Take the preventive measures against flaking
	Cracks on rolling element or lip	Impact during mounting Accidental drop while carrying or handling Progress from flaking	Mount the bearing carefully and precisely Take precautions while carrying or handling Take the preventive measures against flaking
Damaged cage(Fig. 15-6)	Damaged cage(Fig. 15-6)	Abnormal application of load due to improper mounting Improper lubrication	Mount the bearing carefully and precisely Re-examine the lubricant and lubricating method
Indentation Marks(Fig. 15-7,8)	On raceway in interval of a rolling element	Impact load during mounting Excessive load while at rest	Mount the bearing carefully and precisely Re-examine the bearing load capacity
	Minute indentation marks on raceway and roller surface	Intrusion of metal particles or sand, etc.	Clean the surrounding before mounting Improve sealing to prevent foreign particle intrusion

Damaged Shape		Causes	Preventive Measures
Abnormal abrasion (Fig. 15-9)	Abrasion marks on raceway, lip, or cage	Foreign particle intrusion Poor lubrication	Clean the surrounding before mounting Improve sealing to prevent foreign particle intrusion Re-examine the lubricant and lubricating method
	Fretting	Sliding abrasion caused by minute gap	Re-examine the tight-fit interferences Apply grease or equivalent on shaft or housing
	Creep	Insufficient interferences	Re-examine the tight-fit interferences
	False brinelling	Vibration while at rest or carrying Shaking movement of small amplitude	Take the measures against vibration Apply preload Change the lubricant to that with a higher viscosity
Seizure (Fig. 15-10)	Discoloring, softening, and seizure of raceway, rolling element, lip surface	Too small clearance Poor lubrication Improper mounting	Re-examine the clearance or tight-fit interferences Re-examine the lubricant and lubricating method Mount the bearing carefully and precisely
Electric corrosion (Fig. 15-11)	Uneven surface on raceway	Seizure due to sparks generated by passing current	Grounding Use insulation grease Use insulation bearing
Rust, Corrosion (Fig. 15-12, 13)	Happens on inside a bearing Happens on tight-fit surfacea	Intrusion of moisture in the air Fretting Intrusion of corrosive material	Take care while storing Take the measures against fretting Take the measures against varnish, gas, etc.



Fig. 15-1 Generation of Flaking on Inner Ring Raceway of Deep Groove Ball Bearing



Fig. 15-2 Generation of Flaking on Inner Ring Raceway of Deep Groove Bearing

15. Damage to Bearings and Preventive Measures



Fig. 15-3 Scratches on Outer Ring Raceway of Tapered Roller Bearing



Fig. 15-4 Scratches on Larger Side Surface of Tapered Roller Bearing



Fig. 15-5 Crack on Outer Ring Raceway of Deep Groove Ball Bearing



Fig. 15-6 Damaged Cage of Tapered Roller Bearing



Fig. 15-7 Indentation Marks on Outer Ring Raceway of Tapered Roller Bearing

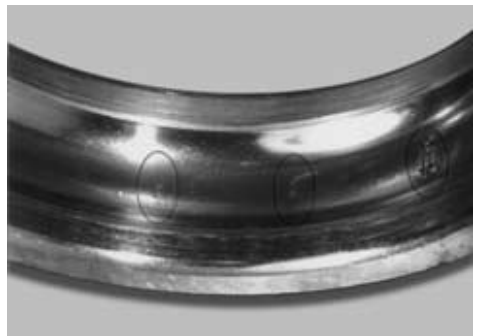

Fig. 15-8 Indentation and Flaking on Outer Ring Raceway of Deep Groove Ball Bearing



Fig. 15-9 Creep on Outer Ring Surface of Deep Groove Ball Bearing

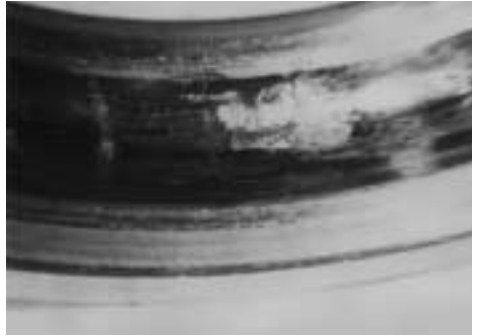

Fig. 15-10 Seizure on Outer Ring Raceway of Deep Groove Ball Bearing

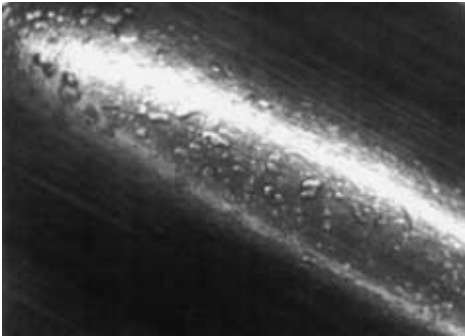

Fig. 15-11 Electric Corrosion on Outer Ring Surface of Deep Groove Ball Bearing



Fig. 15-12 Corrosion on Tapered Roller Bearing

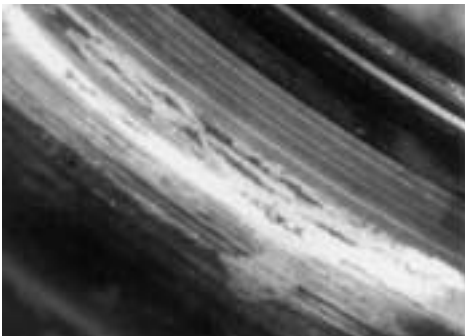

Fig. 15-13. Corrosion on Outer Ring Raceway of Deep Groove Ball Bearing

16. Packages

KBC adapts contents, dimensions and weights of original packages to the customer requirements, specially with regard to easy handling.

The following packing units are used as original packages.

Individual Package “P,L”

Contents: 1 piece

A bearing is wrapped individually in plastic foil first, and then it is put in a small folding paper box, and these are put in a medium-sized box again.

Plastic foil is clear on one side, so that bearing sealing type can be identified, and only a basic number code is printed on foil out of bearing Specification Code. The complete Specification Code is shown only on medium-sized box.

These packages are generally for repair parts or

for retailers.

Roll Package “U”

Contents: Multiples of 5(Except some medium-sized bearings)

They are usually wrapped in 10-piece unit in paper or plastic foil, and then they are put in cardboard(Code R. In case of separately packing inner and outer rings of separable bearings, Code 1) or hard plastic boxes(Paper roll is Code X; Plastic foil roll is Code C; In case of separately packing inner and outer rings of separable bearings, Code is No. 4).

These packages are usually for customers consuming rather large quantity of bearings. The contents of opened packing units should be used as quickly as possible



Fig. 16-1 Individual Package(Paper box)-P



Fig. 16-3 Roll Package(Cardboard box)-U



Fig. 16-2 Individual Package(Plastic foil and middle box)-L



Fig. 16-4 Roll Package(Hard plastic box)-C, X

Bulk Package “G, T, Y”

Contents: Differs depending on the sizes of products

In consideration of conserving packing materials, bearings are packed individually in a plastic foil, but not in an individual paper box.

They are put in cardboard boxes(Code G. In case of separately packing inner and outer rings of separable bearings, Code 5) or hard plastic boxes(Code T or Y; In case of separately packing inner and outer rings of separable bearings, Code is No. 2 or 3).

These packages are usually for customers consuming rather large quantity of bearings. The contents of opened packing units should be used as quickly as possible.



Fig. 16-5 Bulk Package(Hard plastic box)-T, Y

Dimension Table



69, 60, 62, 62,
160, BR, HC



ZZ



DD



UU



72, 73



SM



BS



SA



SDA9



SDA0103



SDA0109



302, 303, 320,
322, 323, 330,
332, TR

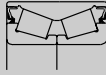

DT

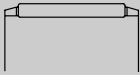

K

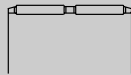

K...ZW, K...SP



UC2



UB2

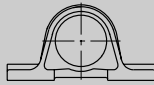

P2



F2

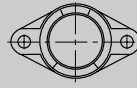

FL2

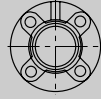

FC2

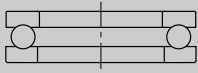

511

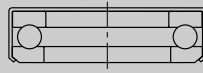

S

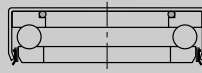

S...V

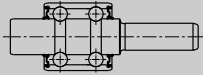

BW

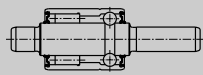

RW

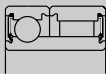

CLT...T

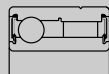

CLT...A

Deep Groove Ball Bearings



SDA0106



SDA0112



SDA0102

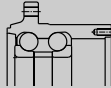

SDA0107

Angular Contact Ball Bearings, single row
Angular Contact Ball Bearings, double row

Tapered Roller Bearings, single row
Tapered Roller Bearings, double row

Needle Roller Bearings

Unit Bearings

Thrust Ball Bearings

Bearings for Water Pumps

One-way Clutch Solid Bearings

Ceramic Bearings
Vacuum Bearings

KBC Deep Groove Ball Bearings



KBC Deep Groove Ball Bearings

Standards · Basic Designs · Tolerances · Bearing Clearance · Cages · Alignment

Standards

Single row deep groove ball bearings KS B 2023

Basic Designs

Deep groove ball bearings are available as open design, and sealed design with either non-contact or contact seal. Availability of various KBC designs makes it possible for the customers to choose right kind of bearing suitable for their specific operating and environmental conditions.

Sealed bearings have grooves on inner ring for seals, but open type bearings do not have grooves on them as principle. However, Bearings which are supplied as sealed basic design may have grooves in the outer ring for the seals or shields also as open bearings, due to manufacturing reasons.

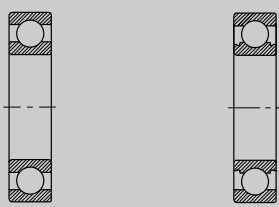

Open Deep Groove Ball Bearing

Open Deep Groove Ball Bearing with grooves in the inner ring

▼ Existence of Seal Grooves in KBC Open Deep Groove Ball Bearings

With Seal Grooves on Inner Ring	No Seal Grooves on Inner Ring
6000 ~ 5	6006 ~
6200 ~ 4	6205 ~
6300 ~ 3	6304 ~

Tolerances

Single row deep groove ball bearings of basic design have normal tolerances.

Bearings with narrow tolerances are supplied on request.

Tolerances: Refer to Table 7-2 Tolerances of Radial Bearings on Page 68.

Bearing Clearances

Single row deep groove ball bearings of basic design have normal clearances (MC3 Clearance for small-sized bearings.) Bearings with an increased bearing clearance are supplied on request.

Radial Clearances: Refer to Table 9-1 Radial Internal Clearances of Single Row Deep Groove Ball Bearings on Page 92, and Table 9-2 Radial internal Clearances of Small Diameter Deep Groove Ball Bearings on Page 92.

Cages

Basic deep groove ball bearings without cage suffix are fitted with a pressed steel cage. Pressed steel cage specially treated to improve abrasion-resistance and oil-proof quality are available also on request.

polyamide 66 cages can be used at operating temperatures of up to 120°C over extended periods. If the bearings are lubricated with oil, any additives contained in the oil may reduce the cage service life. Also, aged oil may reduce the cage life at higher temperatures; therefore, the oil change intervals have to be strictly observed

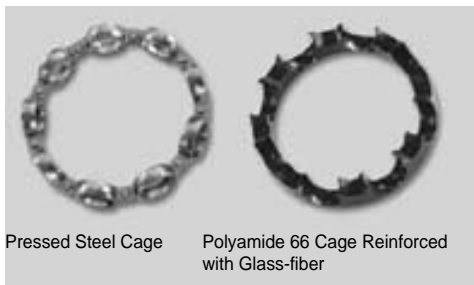

Alignment

The self-aligning capacity of deep groove ball bearings is limited; this calls for well aligned bearing seats. Misalignment impairs the smooth running of the balls, induces additional stress in the bearing and consequently reduces the bearing service life.

KBC Deep Groove Ball Bearings

Speed Suitability · Heat Treatment · Sealed Bearings · Equivalent Loads

In order to keep additional stressing within reasonable limits, only minor misalignments - depending on the load - are permissible for deep groove ball bearings.

▼ Angle of Misalignment in Angular Minutes		
Bearing Series	Low Loads	High Loads
62, 63	5'...10'	8'...16'
69, 160, 60	2'... 6'	5'...10'

Speed Suitability

Deep groove ball bearings are suitable for high speeds. Permissible speeds of bearings lubricated by grease or oil are listed on the Dimension Tables.

In the cases exceeding normal load conditions (When an applied load to a bearing is less than 8% of dynamic load rating and when axial load is less than 20% of radial load.), contact KBC.

Heat Treatment

KBC deep groove ball bearings are heat-treated in such a way that they can be used at operating temperatures of up to 120°C. If ordinary bearings are used at a temperature above 120°C, their hardness or dimension can be lowered or changed. The special bearings treated for stability even at the temperatures up to 350°C are available on request.

The operating temperatures of KBC deep groove ball bearings, which have been treated for dimensional stability under high temperatures, are shown below.

Care should be taken for sealed bearings and bearings with polyamide cages to observe the operating temperature limits.

▼ Operating Temperatures of KBC Deep Groove Ball Bearings, dimensionally stable under high temperatures.	
Suffix	Max. Temperature
S0	150°C
S1/SH1/SS1	200°C
SH2/SS2	250°C
SH3	300°C
SH4	350°C

Sealed Deep Groove Ball Bearings

In addition to open deep groove ball bearings, KBC supplies as basic designs also deep groove ball bearings with shields (Non-contact steel plate seals) or seals (Contact seals) on both sides. All these bearings are filled at the manufacturer's plant with a high-quality grease, tested to KBC specifications.

Sealed bearings get to be sealed completely by labyrinth formed between seal groove on inner ring and shield bore.

Sealed bearings are divided into two types depending on existence of contact between seal lip and bearing inner ring, namely contact and non-contact types. Non-contact seals, which create small and long labyrinth, have better sealing quality than shield type, although they produce about same torque performances.

Contact seals are excellent sealers, but their torque and permissible speeds are inferior than those of shield or non-contact types.

KBC supplies also other kinds of sealed bearings with seals of various shapes and materials, suitable for all kinds of operational environment of the customers. Contact KBC for details.

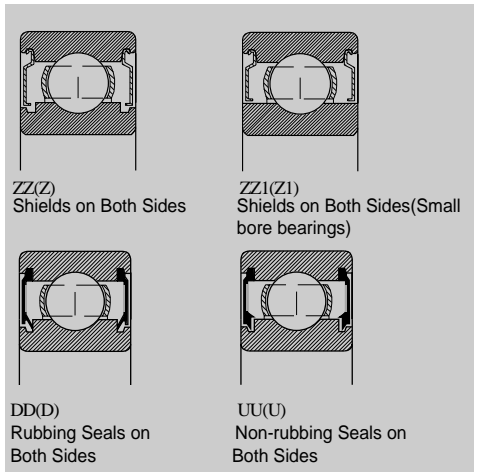

KBC Deep Groove Ball Bearings

Equivalent Loads • Special Bearings • Abutment Dimensions • Prefixes • Suffixes

Equivalent Dynamic Load

$$P = X \cdot F_r + Y \cdot F_a$$

The contact angle of deep groove ball bearings increases with the axial load. Therefore, the factors X and Y depend on F_a/C_0 , as shown on below Table.

▼ Radial Factors and Thrust Factors for Deep Groove Ball Bearings					
F_a/C_0	e	$F_a/F_r \leq e$		$F_a/F_r > e$	
		X	Y	X	Y
0.014	0.19	1	0	0.56	2.30
0.028	0.22	1	0	0.56	1.99
0.056	0.26	1	0	0.56	1.71
0.084	0.28	1	0	0.56	1.55
0.11	0.30	1	0	0.56	1.45
0.17	0.34	1	0	0.56	1.31
0.28	0.38	1	0	0.56	1.15
0.42	0.42	1	0	0.56	1.04
0.56	0.44	1	0	0.56	1.00

Equivalent Static Load

$$P_0 = F_r \quad : \quad \frac{F_a}{F_r} \leq 0.8 \text{ for}$$

$$P_0 = 0.6 \cdot F_r + 0.5 \cdot F_a \quad : \quad \frac{F_a}{F_r} > 0.8 \text{ for}$$

Special Bearings

KBC has developed some special deep groove ball bearings, suitable to used under various special and extreme operating conditions.

Some of them are; Creep-prevention bearings with two plastic resin bands on outside surface(Prefix EC), ceramic bearings for high-speeds with excellent chemical-resistance, heat-resistance, and vacuum bearings coated with solid lubricant, polymer bearings with solid lubricant, 4-point contact ball bearings restricting axial clearance variations against radial clearance by tight-fits. Contact KBC for details.

Abutment Dimensions

The bearing rings should closely fit the shaft or housing shoulder; they must not be allowed to foul

the shoulder fillet radius. Consequently, the maximum fillet radius R of the mating part must be smaller than the minimum corner, r_{min} , of the deep groove ball bearing.

The shoulder of mating parts must be so high that even with maximum bearing corner there is an adequate abutment surface area. The Dimension

Table on the next pages list the maximum fillet radius, R, and the minimum shoulder height of shaft, D_s , and the maximum shoulder diameter of housing, d_h .

Prefix

- BR** Basic dimensions(bore diameter, outer diameter, width) and inter designs differ from the standards.
- EC** For creep prevention
- HC** High-load capacity design

Suffix

- A** Inter design differs from the standards.
- F1** Bore diameter differs from the standards.
- F2** Outer diameter differs from the standards.
- h** Width differs from the standards.
- HL** Long life, special heat treatment
- PC** Glass-fiber reinforced polyamide 66 cage
- SL** Pressed steel cage with low temperature nitriding treatment
- ZZ** Shields on both sides
- UU** Non-rubbing seals on both sides
- DD** Rubbing seals on both sides

KBC Deep Groove Ball Bearings

Single Row

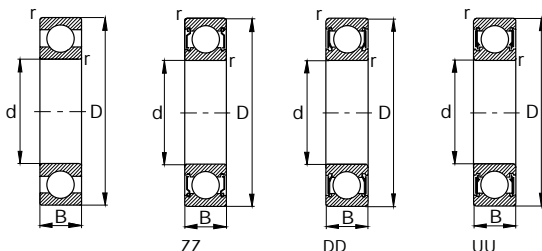

Shaft	Dimensions				Abutment Dimensions		
	d mm	D	B	r min	D _s min	d _n max	R max
8	8	22	7	0.3	10	20	0.3
	8	22	7	0.3	10	20	0.3
	8	22	7	0.3	10	20	0.3
	8	22	7	0.3	10	20	0.3
	8	22	7	0.3	10	20	0.3
	8	28	9	0.3	10	26	0.3
10	10	26	8	0.3	12	24	0.3
	10	26	8	0.3	12	24	0.3
	10	26	8	0.3	12	24	0.3
	10	26	8	0.3	12	24	0.3
	10	27	11	0.3	12	25	0.3
	10	30	8	0.6	14	26	0.6
	10	30	9	0.6	14	26	0.6
	10	30	9	0.6	14	26	0.6
	10	30	9	0.6	14	26	0.6
	10	30	9	0.6	14	26	0.6
	10	35	11	0.6	14	31	0.6
	10	35	11	0.6	14	31	0.6
	10	35	11	0.6	14	31	0.6
	10	35	11	0.6	14	31	0.6
	12	12	28	8	0.3	14	26
12		28	8	0.3	14	26	0.3
12		28	8	0.3	14	26	0.3
12		28	8	0.3	14	26	0.3
12		32	10	0.6	16	28	0.6
12		32	10	0.6	16	28	0.6
12		32	10	0.6	16	28	0.6
12		32	10	0.6	16	28	0.6
12		37	12	1	17	32	1
12		37	12	1	17	32	1
12		37	12	1	17	32	1
12		37	12	1	17	32	1
12.7	12.7	32	10	0.6	17	27.5	0.6
13	13	31	7	0.3	15	29	0.3
15	15	32	9	0.3	17	30	0.3
	15	32	9	0.3	17	30	0.3
	15	32	9	0.3	17	30	0.3
	15	32	9	0.3	17	30	0.3
	15	32	9	0.3	17	30	0.3

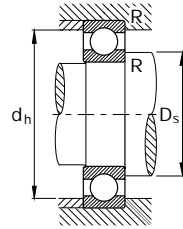

Load Rating				Permissible Speed		Standards	Weight
Dynamic C		Static C ₀		Grease Lubrication	Oil	Bearing	≈
N	kgf	N	kgf	min ⁻¹		KBC	kg
3300	336	1370	140	34000	40000	608	0.012
3300	336	1370	140	34000		608ZZ1	0.012
3300	336	1370	140	34000		608UUG	0.012
3300	336	1370	140	28000		608DDG	0.012
4550	464	1960	200	28000	34000	638ZZ	0.025
4550	464	1960	200	30000	36000	6000	0.018
4550	464	1960	200	30000		6000ZZ	0.018
4550	464	1960	200	30000		6000UU	0.018
4550	464	1960	200	22000		6000DD	0.018
4550	464	1960	200	19000		EC6000DDF2h	0.022
5100	520	2390	244	24000	30000	6200h	0.023
5100	520	2390	244	24000	30000	6200	0.031
5100	520	2390	244	24000		6200ZZ	0.032
5100	520	2390	244	24000		6200UU	0.032
5100	520	2390	244	18000		6200DD	0.032
8100	826	3450	352	22000	26000	6300	0.051
8100	826	3450	352	22000		6300ZZ	0.053
8100	826	3450	352	22000		6300UU	0.053
8100	826	3450	352	17000		6300DD	0.053
5100	520	2370	242	28000	32000	6001	0.021
5100	520	2370	242	28000		6001ZZ	0.021
5100	520	2370	242	28000		6001UU	0.021
5100	520	2370	242	18000		6001DD	0.021
6800	693	3050	311	22000	28000	6201	0.036
6800	693	3050	311	22000		6201ZZ	0.038
6800	693	3050	311	22000		6201UU	0.038
6800	693	3050	311	17000		6201DD	0.038
9700	989	4200	428	20000	24000	6301	0.058
9700	989	4200	428	20000		6301ZZ	0.06
9700	989	4200	428	20000		6301UU	0.06
9700	989	4200	428	16000		6301DD	0.06
6800	693	3050	311	22000		6201ZZF1	0.037
6800	693	3050	311	23000	28000	BR1331	0.066
5600	571	2840	290	24000	28000	6002	0.03
5600	571	2840	290	24000		6002ZZ	0.032
5600	571	2840	290	24000		6002UU	0.032
5600	571	2840	290	15000		6002DD	0.032
5600	571	2840	290	15000		EC6002DD	0.03

Bearings of different designs can be custom-made on request.

KBC Deep Groove Ball Bearings

Single Row

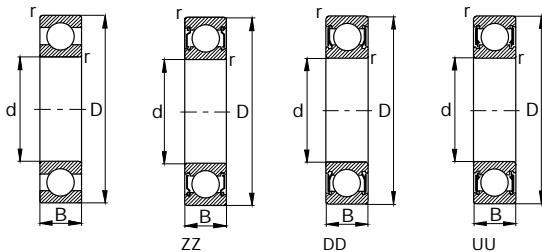

Shaft	Dimensions				Abutment Dimensions		
	d	D	B	r min	D _a min	d _n max	R max
	mm						
15	15	35	11	0.6	19	31	0.6
	15	35	11	0.6	19	31	0.6
	15	35	11	0.6	19	31	0.6
	15	35	11	0.6	19	31	0.6
	15	35	11	0.6	19	31	0.6
	15	40	11	0.6	19	36	0.6
	15	40	11	0.6	19	36	0.6
	15	42	13	1	20	37	1
	15	42	13	1	20	37	1
	15	42	13	1	20	37	1
	15	42	13	1	20	37	1
	15	42	13	1	20	37	1
	15	42	13	1	20	37	1
	15	47	14	1	20	42	1
	15.875	15.875	34.925	11	0.6	20	31
15.875		35	11	0.6	20	31	0.6
15.875		40	12	0.6	20	36	0.6
16	16	35	11	0.6	20	31	0.6
17	17	30	7	0.3	19	28	0.3
	17	30	7	0.3	19	28	0.3
	17	30	7	0.3	19	28	0.3
	17	35	10	0.3	19	33	0.3
	17	35	10	0.3	19	33	0.3
	17	35	10	0.3	19	33	0.3
	17	35	10	0.3	19	33	0.3
	17	40	12	0.6	21	36	0.6
	17	40	12	0.6	21	36	0.6
	17	40	12	0.6	21	36	0.6
	17	40	12	0.6	21	36	0.6
	17	40	12	0.6	21	36	0.6
	17	42	12	0.6	21	36	0.6
	17	42	13	1	21	36.5	1
	17	47	14	1	22	42	1
	17	47	14	1	22	42	1
	17	47	14	1	22	42	1
	17	47	14	1	22	42	1
	17	47	17	1	22	41.5	1

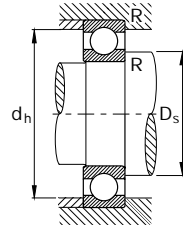

Load Rating				Permissible Speed		Standards	Weight
Dynamic C		Static C ₀		Grease Lubrication	Oil	Bearing	≈
N	kgf	N	kgf	min ⁻¹		KBC	kg
7650	780	3700	377	20000	24000	6202	0.044
7650	780	3700	377			6202ZZ	0.046
7650	780	3700	377	20000		6202UU	0.046
7650	780	3700	377	14000		6202DD	0.046
7650	780	3700	377	14000		EC6202DD	0.044
7650	780	3700	377	20000		6202ZZF2	0.048
7650	780	3700	377	20000		6202UUF2	0.048
11400	1160	5450	556	17000	20000	6302	0.081
13300	1360	5900	601	18000	22000	HC6302	0.082
11400	1160	5450	556	17000		6302ZZ	0.083
11400	1160	5450	556	17000		6302UU	0.083
11400	1160	5450	556	13000		6302DD	0.083
11400	1160	5450	556	13000		EC6302DD	0.083
13650	1390	6600	673	11900		AT303/15DD	0.132
7650	780	3700	377	14000		99502H	0.04
7650	780	3700	377	14000		6202DDF11	0.04
9550	973	4800	489	12000		6203DDF1	0.069
7650	780	3700	377	14000		6202DDF1	0.04
4600	469	2550	260	24000	28000	6903	0.017
4600	469	2550	260	24000		6903ZZ	0.019
4600	469	2550	260	15000		6903DD	0.019
6000	612	3250	331	22000	26000	6003	0.041
6000	612	3250	331	22000		6003ZZ	0.043
6000	612	3250	331	22000		6003UU	0.043
6000	612	3250	331	13000		6003DD	0.043
9550	973	4800	489	17000	20000	6203	0.065
9550	973	4800	489	17000		6203ZZ	0.067
9550	973	4800	489	17000		EC6203ZZ	0.067
9550	973	4800	489	17000		6203UU	0.067
9550	973	4800	489	12000		6203DD	0.067
9550	973	4800	489	12000		6203DDF2	0.071
11400	1160	5450	556	13000		EC6302DDF1	0.072
13600	1390	6600	673	15000	18000	6303	0.11
13600	1390	6600	673	15000		6303ZZ	0.113
13600	1390	6600	673	15000		6303UU	0.113
13600	1390	6600	673	11000		6303DD	0.113
13600	1390	6600	673	11000		6303DDh	0.189

Bearings of different designs can be custom-made on request.

KBC Deep Groove Ball Bearings

Single Row

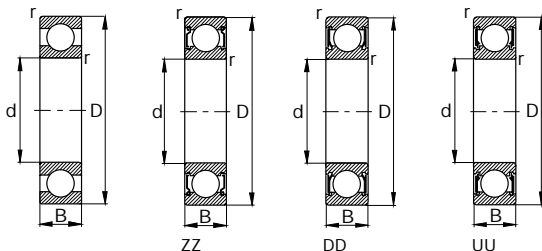

Shaft	Dimensions				Abutment Dimensions		
	d mm	D	B	r min	D _a min	d _n max	R max
17	17	52	15	1.1	24	45	1
	17	52	18	1	22.5	46.5	1
19	19	33	7	0.5	22	30	0.5
	19	35	7	0.3	21	33	0.3
	19	35.7	7	0.3	21	34	0.3
19.05	19.05	30	6.35	0.3	21	28	0.3
	19.05	34.15	6.35	0.3	21	32	0.3
20	20	35	8	0.5	22	33	0.5
	20	36	9	0.3	22	34	0.3
	20	37	9	0.3	22	35	0.3
	20	37	9	0.3	22	35	0.3
	20	37	9	0.3	22	35	0.3
	20	42	12	0.6	23.5	38.5	0.6
	20	42	12	0.6	23.5	38.5	0.6
	20	42	12	0.6	23.5	38.5	0.6
	20	42	12	0.6	23.5	38.5	0.6
	20	47	14	1	25.5	41.5	1
	20	47	14	1	25.5	41.5	1
	20	47	14	1	25.5	41.5	1
	20	47	14	1	25.5	41.5	1
	20	47	14	1	25.5	41.5	1
	20	49	16	0.3	22.5	46.5	0.3
	20	52	15	1.1	27	45	1
	20	52	15	1.1	27	45	1
	20	52	15	1.1	27	45	1
	20	52	15	1.1	27	45	1
	20	62	16	0.5	24	57.5	0.5
20	62	17	1.1	27	55	1	
22	22	42	12	0.6	25.5	39	0.6
	22	50	14	1	27.5	44.5	1
	22	50	14	1	27.5	44.5	1
	22	56	15	1.1	29	49	1

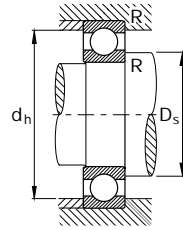

Load Rating				Permissible Speed Grease Lubrication	Oil	Standards Bearing	Weight ≈
Dynamic C	static C ₀						
N	kgf	N	kgf	min ⁻¹		KBC	kg
15900	1620	7850	800	11000		6304DDF11	0.198
18200	1860	9050	923	11000		BR1752DD	0.174
4850	494	2860	292	20000	23000	BR1933	0.021
4550	464	2620	267	19000	23000	BR1935	0.026
6000	612	3250	331	19000	23000	BR1936	0.026
3500	357	2210	225	21000	25000	BR1930	0.017
4850	494	2860	292	20000	23000	BR1934	0.024
4550	464	2620	267	19000	22000	BR2035	0.027
6350	647	3700	377	19000	22000	6904F2	0.033
6350	647	3700	377	19000	22000	6904	0.037
6350	647	3700	377	19000		6904ZZ	0.039
6350	647	3700	377	12000		6904DD	0.039
9400	958	5000	510	18000	20000	6004	0.067
9400	958	5000	510	18000		6004ZZ	0.07
9400	958	5000	510	18000		6004UU	0.07
9400	958	5000	510	11000		6004DD	0.07
12800	1310	6650	678	15000	18000	6204	0.104
15700	1600	7700	785	15000	18000	HC6204	0.105
12800	1310	6650	678	15000		6204ZZ	0.108
12800	1310	6650	678	15000		6204UU	0.108
12800	1310	6650	678	11000		6204DD	0.108
14700	1500	7150	729	11000		BR2049DD	0.13
15900	1620	7850	800	14000	17000	6304	0.141
15900	1620	7850	800	14000		6304ZZ	0.145
15900	1620	7850	800	14000		6304UU	0.145
15900	1620	7850	800	10000		6304DD	0.145
19400	1980	11300	1150	13000	15000	6206/20	0.245
20600	2100	11200	1140	8000		6305DDF11	0.288
9400	958	5000	510	18000	20000	6004/22	0.061
12900	1320	6800	693	14000	16000	62/22	0.116
12900	1320	6800	693	9500		62/22DD	0.119
18500	1890	9350	953	13000	16000	63/22h	0.165

Bearings of different designs can be custom-made on request.

KBC Deep Groove Ball Bearings

Single Row

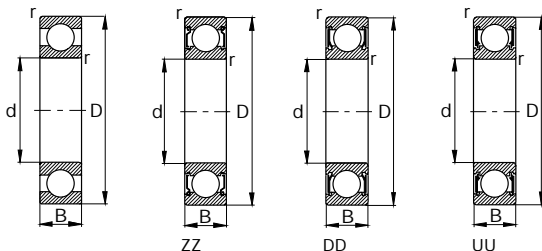

Shaft	Dimensions				Abutment Dimensions			
	d mm	D	B	r min	D _a min	d _b max	R max	
22	22	56	16	1.1	29	49	1	
	22	56	16	1.1	29	49	1	
24	24	40	8	0.3	26.5	37.5	0.3	
25	25	42	9	0.3	27	40	0.3	
	25	47	12	0.6	28	43.5	0.6	
	25	47	12	0.6	28	43.5	0.6	
	25	47	12	0.6	28	43.5	0.6	
	25	47	12	0.6	28	43.5	0.6	
	25	52	15	1	30	47	1	
	25	52	15	1	30	47	1	
	25	52	15	1	30	47	1	
	25	52	15	1	30	47	1	
	25	52	15	1	30	47	1	
	25	62	17	1.1	32	55	1	
	25	62	17	1.1	32	55	1	
	25	62	17	1.1	32	55	1	
	25	62	17	1.1	32	55	1	
	25	25	63	18	0.6	29	59	0.6
25		63	18	0.6	29	59	0.6	
25		68	18	0.6	29	64	0.6	
25		68	21	0.6	29	64	0.6	
27		27	58	16	1	32.5	52.5	1
		27	68	18	1.1	29.5	61	1
28	28	52	16	0.6	32	48	0.6	
	28	58	16	1	33.5	52.5	1	
	28	58	16	1	33.5	52.5	1	
	28	58	16	1	33.5	52.5	1	
	28	65	19	2	39	54	2	
	28	68	18	1.1	35	61	1	
	28	68	18	1.1	35	61	1	
	28	70	20	0.3	30	68	0.3	
	28	72	20	0.3	30	70	0.3	
	28	80	21	1.5	37	71	1.5	

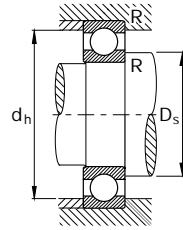

Load Rating				Permissible Speed		Standards	Weight
Dynamic C		static C ₀		Grease Lubrication	Oil	Bearing	≈
N	kgf	N	kgf	min ⁻¹		KBC	kg
18500	1890	9350	953	13000	16000	63/22	0.175
18500	1890	9350	953	9500		63/22DD	0.177
6700	683	4150	423	16000	19000	BR2440	0.05
7050	719	4550	464	16000	19000	6905	0.042
10100	1030	5800	591	15000	18000	6005	0.078
10100	1030	5800	591	15000		6005ZZ	0.08
10100	1030	5800	591	15000		6005UU	0.08
10100	1030	5800	591	9500		6005DD	0.08
14000	1430	7900	805	13000	15000	6205	0.126
14000	1430	7900	805	13000		6205ZZ	0.13
14000	1430	7900	805	13000		6205UU	0.13
14000	1430	7900	805	9000		6205DD	0.13
17700	1800	9350	953	9100		HC6205DD	0.127
20600	2100	11200	1140	11000	13000	6305	0.23
20600	2100	11200	1140	11000		6305ZZ	0.236
20600	2100	11200	1140	11000		6305UU	0.236
20600	2100	11200	1140	8000		6305DD	0.236
23700	2420	12200	1240	12000	14000	B25-63	0.252
23700	2420	12200	1240			B25-63DD	0.257
31000	3160	15200	1550	11000	13000	B25-157	0.286
31000	3160	15200	1550	7700		B25-157DDh	0.312
16600	1690	95500	973	8000		62/28DDF1	0.192
26700	2720	14000	1430	7500		63/28DDF11	0.298
14000	1430	7900	805	8800		BR2852DD	0.133
16600	1690	9550	973	12000	14000	62/28	0.172
16600	1690	9550	973	8000		62/28DD	0.174
17900	1830	9750	994	8200		HC62/28DD	0.173
26500	2700	13800	1410	7600		BR2865DD	0.256
26700	2720	14000	1430	10000	13000	63/28	0.281
26700	2720	14000	1430	7500		63/28DD	0.283
29700	3030	15700	1600	7200		BR2870DD	0.34
29800	3040	16900	1720	7000		BR2872DD	0.374
39500	4030	21600	2200	9300	12000	HC6307F11	0.507

Bearings of different designs can be custom-made on request.

KBC Deep Groove Ball Bearings

Single Row

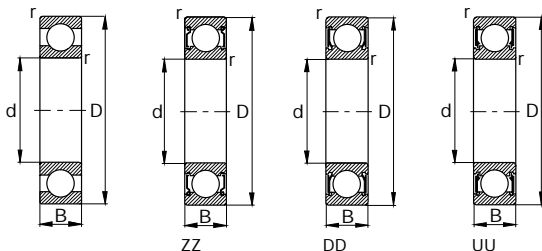

Shaft	Dimensions				Abutment Dimensions		
	d mm	D	B	r min	D _a min	d _b max	R max
30	30	55	9	0.3	32	53	0.3
	30	55	11.6	1	35	50	1
	30	55	13	1	35	50	1
	30	55	13	1	35	50	1
	30	55	13	1	35	50	1
	30	62	10	0.6	34	58	0.6
	30	62	16	1	35	57	1
	30	62	16	1	35	57	1
	30	62	16	1	35	57	1
	30	62	16	1	35	57	1
	30	62	16	1	35	57	1
	30	62	17	1	35	57	1
	30	72	19	1.1	37	65	1
	30	72	19	1.1	37	65	1
	30	72	19	1.1	37	65	1
30	72	19	1.1	37	65	1	
30	72	19	1.1	37	65	1	
30	75	20	1.1	37	68	1	
30	80	22	1.5	39	71	1.5	
32	32	75	20	1.1	39	68	1
	32	90	23	1.5	41	81	1.5
	32	90	25	1.5	41	81	1.5
35	35	62	9	0.3	37	60	0.3
	35	62	14	1	40	57	1
	35	62	14	1	40	57	1
	35	62	14	1	40	57	1
	35	62	14	1	40	57	1
	35	66	15	1	40.5	60.5	1
	35	72	16	1.1	41.5	65.5	1
	35	72	17	1.1	41.5	65.5	1
	35	72	17	1.1	41.5	65.5	1
	35	72	17	1.1	41.5	65.5	1
	35	72	17	1.1	41.5	65.5	1
	35	72	18.25	1.1	41.5	65.5	1
	35	80	21	1.5	43	72	1.5

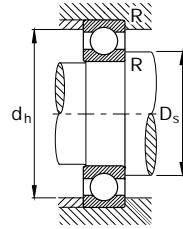

Load Rating				Permissible Speed		Standards	Weight
Dynamic C		Static C ₀		Grease Lubrication	Oil	Bearing	≈
N	kgf	N	kgf	min ⁻¹		KBC	kg
11200	1140	7350	749	13000	15000	16006	0.081
13200	1350	8300	846	13000		6006UUh1	0.096
13200	1350	8300	846	13000	15000	6006	0.113
13200	1350	8300	846	13000		6006ZZ	0.117
13200	1350	8300	846	8000		6006DD	0.117
15000	1530	9200	938	11000	13000	68206	0.127
19400	1980	11300	1150	11000	13000	6206	0.196
23400	2390	12900	1320	11000	14000	HC6206	0.197
19400	1980	11300	1150	11000		6206ZZ	0.202
19400	1980	11300	1150	11000		6206UU	0.202
19400	1980	11300	1150	7500		6206DD	0.202
23400	2390	12900	1320	7700		HC6206DDh	0.197
26600	2710	15000	1530	9500	12000	6306	0.339
32500	3310	17300	1760	9900	12000	HC6306	0.34
26600	2710	15000	1530	9500		6306ZZ	0.328
26600	2710	15000	1530	9500		6306UU	0.328
26600	2710	15000	1530	6700		6306DD	0.328
29800	3040	16900	1720	6300		63/32DDF1	0.42
39500	4030	21600	2200	6400		HC6307DDF1h	0.51
29800	3040	16900	1720	6300		63/32DD	0.383
40500	4130	23900	2440	5700		6308/32DD	0.702
47000	4790	26300	2680	5800		HC6308/32DDh	0.713
12200	1240	8900	907	11000	13000	16007	0.115
16000	1630	10300	1050	11000	13000	6007	0.147
16000	1630	10300	1050	11000		6007ZZ	0.15
16000	1630	10300	1050	11000		6007UU	0.15
16000	1630	10300	1050	6700		6007DD	0.15
18900	1930	11700	1190	7000		BR3566DD	0.2
25700	2620	15400	1570	9500	11000	6207h2	0.264
25700	2620	15400	1570	9500	11000	6207	0.279
25700	2620	15400	1570	9500		6207ZZ	0.285
25700	2620	15400	1570	9500		6207UU	0.285
25700	2620	15400	1570	6300		6207DD	0.285
25700	2620	15400	1570	9500	11000	6207h	0.298
33500	3420	19200	1960	8500	10000	6307	0.449

Bearings of different designs can be custom-made on request.

KBC Deep Groove Ball Bearings

Single Row

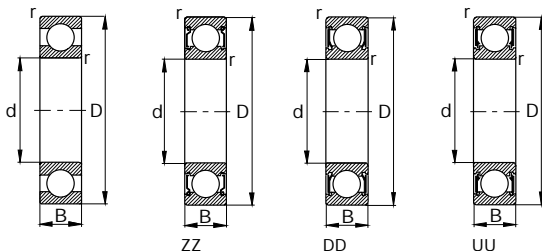

Shaft	Dimensions				Abutment Dimensions		
	d mm	D	B	r min	D _a min	d _n max	R max
35	35	80	21	1.5	43	72	1.5
	35	80	21	1.5	43	72	1.5
	35	80	21	1.5	43	72	1.5
	35	80	24	1.5	43	72	1.5
	35	85	23	0.3	37.5	82.5	0.3
40	40	68	9	0.3	42	66	0.3
	40	68	15	1	45	63	1
	40	68	15	1	45	63	1
	40	68	15	1	45	63	1
	40	68	15	1	45	63	1
	40	80	18	1.1	46.5	73.5	1
	40	80	18	1.1	46.5	73.5	1
	40	80	18	1.1	46.5	73.5	1
	40	80	18	1.1	46.5	73.5	1
	40	80	18	1.1	46.5	73.5	1
	40	80	18	1.1	46.5	73.5	1
	40	85	20	1	45.5	79.5	1
	40	90	23	1.5	48	82	1.5
	40	90	23	1.5	48	82	1.5
	40	90	23	1.5	48	82	1.5
40	90	23	1.5	48	82	1.5	
40	90	25	1.5	48	82	1.5	
42	42	68	15	1	46.5	63.5	1
43	43	90	25	1.5	52	81	1.5
45	45	75	16	1	50	70	1
	45	75	16	1	50	70	1
	45	75	16	1	50	70	1
	45	75	16	1	50	70	1
	45	80	16	1	50	75	1
	45	85	19	1.1	51.5	78.5	1
	45	85	19	1.1	51.5	78.5	1
	45	85	19	1.1	51.5	78.5	1
	45	85	19	1.1	51.5	78.5	1
	45	100	25	1.5	53	92	1.5
	45	100	25	1.5	53	92	1.5
	45	100	25	1.5	53	92	1.5
	45	100	25	1.5	53	92	1.5

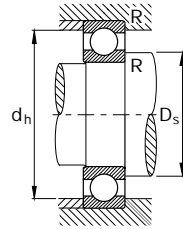

Load Rating				Permissible Speed		Standards	Weight
Dynamic C		Static C ₀		Grease Lubrication	Oil	Bearing	≈
N	kgf	N	kgf	min ⁻¹		KBC	kg
33500	3420	19200	1960	8500		6307ZZ	0.459
33500	3420	19200	1960	8500		6307UU	0.459
33500	3420	19200	1960	6000		6307DD	0.459
39500	4030	21600	2200	6100		HC6307DDh1	0.505
43000	4380	23600	2410	5900		BR3585DD	0.583
12600	1280	9650	984	10000	12000	16008	0.147
16800	1710	11500	1170	10000	12000	6008	0.186
16800	1710	11500	1170	10000		6008ZZ	0.194
16800	1710	11500	1170	10000		6008UU	0.194
16800	1710	11500	1170	6000		6008DD	0.194
29100	2970	17800	1810	8500	10000	6208	0.359
32500	3310	20000	2040	8400	10000	HC6208	0.36
29100	2970	17800	1810	8500		6208ZZ	0.369
29100	2970	17800	1810	8500		6208UU	0.369
29100	2970	17800	1810	5600		6208DD	0.369
36500	3720	22600	2300	6200		HC6209DDF1h	0.483
40500	4130	23900	2440	7500	9000	6308	0.62
47000	4790	26300	2680	7700	9300	HC6308	0.621
40500	4130	23900	2440	7500		6308ZZ	0.632
40500	4130	23900	2440	7500		6308UU	0.632
40500	4130	23900	2440	5300		6308DD	0.632
47000	4790	26300	2680	5400		HC6308DDh	0.668
16800	1710	11500	1170	10000	12000	6008/42	0.171
40500	4130	23900	2440	5300		6308DDF1h	0.641
19900	2030	14000	1430	9000	11000	6009	0.236
19900	2030	14000	1430	9000		6009ZZ	0.249
19900	2030	14000	1430	9000		6009UU	0.249
19900	2030	14000	1430	5300		6009DD	0.249
27600	2810	17900	1830	8800	10000	6009F2	0.312
32500	3310	20400	2080	7500	9000	6209	0.413
32500	3310	20400	2080	7500		6209ZZ	0.425
32500	3310	20400	2080	7500		6209UU	0.425
32500	3310	20400	2080	5300		6209DD	0.425
53000	5400	32000	3260	6700	8000	6309	0.811
53000	5400	32000	3260	6700		6309ZZ	0.831
53000	5400	32000	3260	6700		6309UU	0.831
53000	5400	32000	3260	4800		6309DD	0.831

Bearings of different designs can be custom-made on request.

KBC Deep Groove Ball Bearings

Single Row

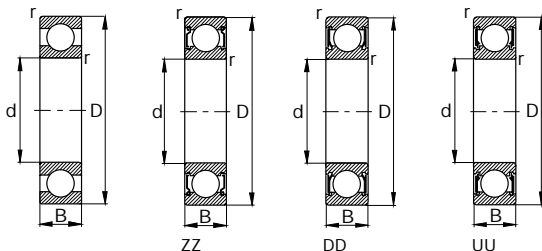

Shaft	Dimensions				Abutment Dimensions			
	d mm	D	B	r min	D _a min	d _n max	R max	
50	50	80	10	0.6	54	76	0.6	
	50	80	16	1	55	75	1	
	50	80	16	1	55	75	1	
	50	80	16	1	55	75	1	
	50	80	16	1	55	75	1	
	50	90	20	1.1	56.5	83.5	1	
	50	90	20	1.1	56.5	83.5	1	
	50	90	20	1.1	56.5	83.5	1	
	50	90	20	1.1	56.5	83.5	1	
	50	110	27	2	59	101	2	
	50	110	27	2	59	101	2	
	50	110	27	2	59	101	2	
	50	110	27	2	59	101	2	
	55	55	90	18	1.1	61.5	83.5	1
		55	90	18	1.1	61.5	83.5	1
55		90	18	1.1	61.5	83.5	1	
55		90	18	1.1	61.5	83.5	1	
55		95	17	0.3	57	93	0.3	
55		100	21	1.5	63	92	1.5	
55		100	21	1.5	63	92	1.5	
55		100	21	1.5	63	92	1.5	
55		100	21	1.5	63	92	1.5	
55		120	29	2	64	111	2	
55		120	29	2	64	111	2	
55		120	29	2	64	111	2	
55		120	29	2	64	111	2	
60		60	95	18	1.1	66.5	88.5	1
		60	95	18	1.1	66.5	88.5	1
	60	95	18	1.1	66.5	88.5	1	
	60	95	18	1.1	66.5	88.5	1	
	60	110	22	1.5	68	102	1.5	
	60	110	22	1.5	68	102	1.5	
	60	110	22	1.5	68	102	1.5	
	60	110	22	1.5	68	102	1.5	
	60	130	31	2.1	71	119	2	
	60	130	31	2.1	71	119	2	
	60	130	31	2.1	71	119	2	
	65	65	100	18	1.1	71.5	93.5	1
65		100	18	1.1	71.5	93.5	1	
65		100	18	1.1	71.5	93.5	1	

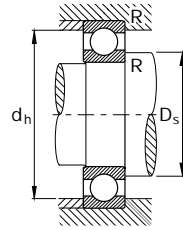

Load Rating				Permissible Speed Grease Lubrication	Oil	Standards Bearing	Weight ≈ kg	
Dynamic C	Static C ₀		min ⁻¹					KBC
	N	kgf						
16000	1630	13200	1350	8500	10000	16010	0.24	
20800	2120	15400	1570	8500	10000	6010	0.256	
20800	2120	15400	1570	8500		6010ZZ	0.263	
20800	2120	15400	1570	8500		6010UU	0.263	
20800	2120	15400	1570	4800		6010DD	0.263	
35000	3570	23200	2370	7100	8500	6210	0.451	
35000	3570	23200	2370	7100		6210ZZ	0.463	
35000	3570	23200	2370	7100		6210UU	0.463	
35000	3570	23200	2370	4800		6210DD	0.463	
62000	6320	38000	3870	6000	7500	6310	1.05	
62000	6320	38000	3870	6000		6310ZZ	1.07	
62000	6320	38000	3870	6000		6310UU	1.07	
62000	6320	38000	3870	4300		6310DD	1.07	
31000	3160	22500	2290	7500	9000	6011	0.373	
31000	3160	22500	2290	7500		6011ZZ	0.384	
31000	3160	22500	2290	7500		6011UU	0.384	
31000	3160	22500	2290	4500		6011DD	0.384	
39000	3980	26200	2670	4700		BR5595	0.43	
43500	4430	29200	2980	6300	7500	6211	0.599	
43500	4430	29200	2980	6300		6211ZZ	0.615	
43500	4430	29200	2980	6300		6211UU	0.615	
43500	4430	29200	2980	4300		6211DD	0.615	
71500	7290	44500	4540	5600	6700	6311	1.35	
71500	7290	44500	4540	5600		6311ZZ	1.38	
71500	7290	44500	4540	5600		6311UU	1.38	
71500	7290	44500	4540	4000		6311DD	1.38	
29400	3000	23200	2370	7100	8500	6012	0.403	
29400	3000	23200	2370	7100		6012ZZ	0.412	
29400	3000	23200	2370	7100		6012UU	0.412	
29400	3000	23200	2370	4000		6012DD	0.412	
52500	5350	36000	3670	5600	7100	6212	0.762	
52500	5350	36000	3670	5600		6212ZZ	0.782	
52500	5350	36000	3670	5600		6212UU	0.782	
52500	5350	36000	3670	3800		6212DD	0.782	
82000	8360	52000	5300	5300	6300	6312	1.7	
82000	8360	52000	5300	5300		6312ZZ	1.72	
82000	8360	52000	5300	5300		6312UU	1.72	
82000	8360	52000	5300	3600		6312DD	1.72	
30500	3110	25200	2570	6700	8000	6013	0.43	
30500	3110	25200	2570	6700		6013ZZ	0.44	
30500	3110	25200	2570	6700		6013UU	0.44	

Bearings of different designs can be custom-made on request.

KBC Deep Groove Ball Bearings

Single Row

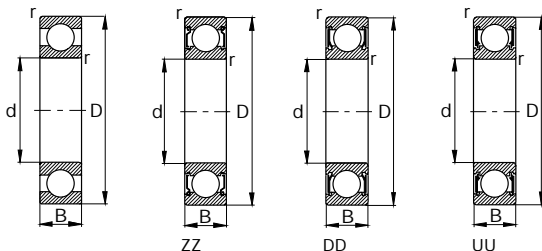

Shaft	Dimensions				Abutment Dimensions			
	d	D	B	r	D_a	d_a	R	
	mm				min	max	max	
65	65	100	18	1.1	71.5	93.5	1	
	65	120	23	1.5	73	112	1.5	
	65	120	23	1.5	73	112	1.5	
	65	120	23	1.5	73	112	1.5	
	65	140	33	2.1	76	129	2	
	65	140	33	2.1	76	129	2	
	65	140	33	2.1	76	129	2	
	65	140	33	2.1	76	129	2	
70	70	110	20	1.1	76.5	103.5	1	
	70	110	20	1.1	76.5	103.5	1	
	70	110	20	1.1	76.5	103.5	1	
	70	110	20	1.1	76.5	103.5	1	
	70	125	24	1.5	78	117	1.5	
	70	125	24	1.5	78	117	1.5	
	70	125	24	1.5	78	117	1.5	
	70	150	35	2.1	81	139	2	
	70	150	35	2.1	81	139	2	
	70	150	35	2.1	81	139	2	
	70	150	35	2.1	81	139	2	
	75	75	115	20	1.1	81.5	108.5	1
75		115	20	1.1	81.5	108.5	1	
75		115	20	1.1	81.5	108.5	1	
75		130	25	1.5	83	122	1.5	
75		130	25	1.5	83	122	1.5	
75		130	25	1.5	83	122	1.5	
75		160	37	2.1	86	149	2	
75		160	37	2.1	86	149	2	
75		160	37	2.1	86	149	2	
80		80	125	22	1.1	86.5	118.5	1
		80	125	22	1.1	86.5	118.5	1
		80	125	22	1.1	86.5	118.5	1
	80	140	26	2	89	131	2	
	80	140	26	2	89	131	2	
	80	140	26	2	89	131	2	
	80	170	39	2.1	91	159	2	
	80	170	39	2.1	91	159	2	
	80	170	39	2.1	91	159	2	
	85	85	130	22	1.1	91.5	123.5	1
		85	130	22	1.1	91.5	123.5	1

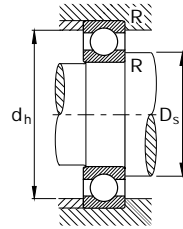

Load Rating				Permissible Speed Grease Lubrication	Oil	Standards Bearing	Weight ≈		
Dynamic C	Static C ₀		min ⁻¹					KBC	kg
	N	kgf							
	30500	3110	25200	2570	4000	6013DD	0.44		
	57000	5810	38500	3930	5300	6300	6213	0.98	
	57000	5810	38500	3930	5300		6213ZZ	1.01	
	57000	5810	38500	3930	3600		6213DD	1.01	
	92500	9430	59500	6070	4800	6000	6313	2.08	
	92500	9430	59500	6070	4800		6313ZZ	2.13	
	92500	9430	59500	6070	4800		6313UU	2.13	
	92500	9430	59500	6070	3400		6313DD	2.13	
	38000	3870	31000	3160	6000	7100	6014	0.598	
	38000	3870	31000	3160	6000		6014ZZ	0.615	
	38000	3870	31000	3160	6000		6014UU	0.615	
	38000	3870	31000	3160	3600		6014DD	0.615	
	62000	6320	44000	4490	5000	6300	6214	1.07	
	62000	6320	44000	4490	5000		6214ZZ	1.1	
	62000	6320	44000	4490	3400		6214DD	1.1	
	104000	10600	68000	6930	4500	5300	6314	2.53	
	104000	10600	68000	6930	4500		6314ZZ	2.58	
	104000	10600	68000	6930	4500		6314UU	2.58	
	104000	10600	68000	6930	3200		6314DD	2.58	
	39500	4030	33500	3420	5600	6700	6015	0.638	
	39500	4030	33500	3420	5600		6015ZZ	0.673	
	39500	4030	33500	3420	3400		6015DD	0.673	
	66000	6730	49500	5050	4800	5600	6215	1.17	
	66000	6730	49500	5050	4800		6215ZZ	1.2	
	66000	6730	49500	5050	3200		6215DD	1.2	
	113000	11500	77000	7850	4300	5000	6315	3.03	
	113000	11500	77000	7850	4300		6315ZZ	3.08	
	113000	11500	77000	7850	2800		6315DD	3.08	
	47500	4840	40000	4080	5300	6300	6016	0.854	
	47500	4840	40000	4080	5300		6016ZZ	0.894	
	47500	4840	40000	4080	3200		6016DD	0.894	
	77500	7900	58500	5960	4500	5300	6216	1.38	
	77500	7900	58500	5960	4500		6216ZZ	1.41	
	77500	7900	58500	5960	3000		6216DD	1.41	
	123000	12500	86500	8820	4000	4800	6316	3.67	
	123000	12500	86500	8820	4000		6316ZZ	3.73	
	123000	12500	86500	8820	2800		6316DD	3.73	
	49500	5050	43000	4380	5000	6000	6017	0.899	
	49500	5050	43000	4380	5000		6017ZZ	0.93	

Bearings of different designs can be custom-made on request.

KBC Angular Contact Ball Bearings

Single Row



KBC Angular Contact Ball Bearings

Single Row • Standards • Basic Designs • Tolerances • Cages

Since single row angular contact ball bearings have contact angles, they can accommodate radial and thrust loads. Also, when a radial load is applied to it, the axial component force is intrinsically generated at the same time. However, since an axial force can be transmitted only in one direction, it is used in combination with another bearing that can transmit the forces of opposite direction.

Standards

Single row angular contact ball bearings KS B 2024

Basic Design

Single row angular contact ball bearings can be divided into a few types depending on the shapes of inner/outer ring tracks and cage guide methods, namely general type, SM type, and sealed BS type. SA type bearings of special dimensions also can be custom-made on request.

A standard contact angle is 30° (Code A, but its marking is omitted), but the contact angles of 40° (Code B) and 15° (Code C), etc. are also available. The bearings with contact angle of 15° (Code C) are classified as above Class P5, and they are used for high precision and speed, and those with 40° (Code

B) can transmit comparatively heavy axial forces.

Tolerances

Normal angular contact ball bearings are machined to normal tolerances.

The ones with finer tolerances can be custom-made on request.

SM and BS types are machined to P5 Class as standard, however, they can be machined up to Class P2 on request. Contact KBC for the details on Class P2 tolerances.

For the tolerances of angular contact ball bearings, see the Table 7-2 Tolerances of Radial Bearings on page

Cages

Most angular contact ball bearings are fitted with a standard cage of glass-fiber reinforced polyamide 66 (Suffix TVP). These cages can be used at operating temperatures of up to 120°C over extended periods.

If the bearings are lubricated with oil, any additives contained in the oil may reduce the cage service life. Also, aged oil may reduce the cage life

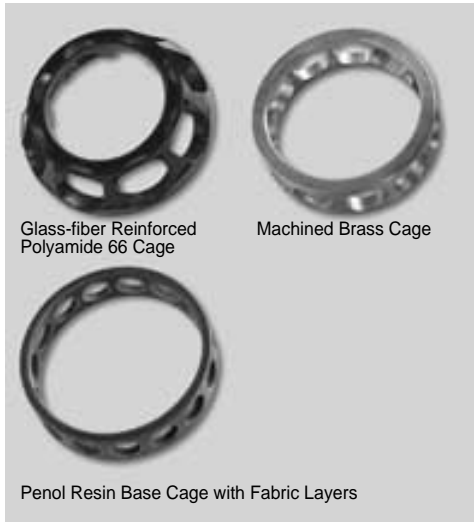
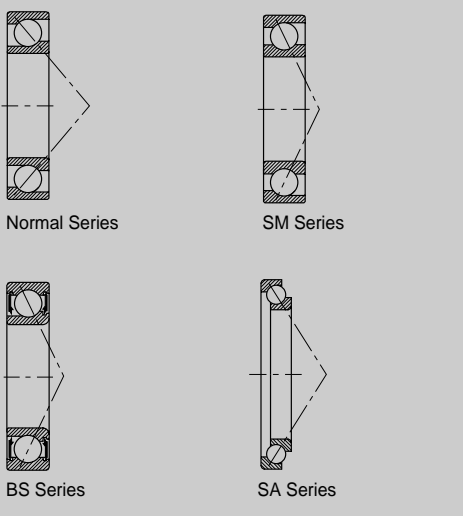

KBC Angular Contact Ball Bearings

Single Row · Speed Suitability

at higher temperatures; therefore, the oil change intervals have to be strictly observed.









Also, there are machined brass cages (Suffix P) and penol resin base cages (Suffix PH) with fabric layers that are suitable for high speed operations, such as spindles and others.

Speed Suitability

Angular contact ball bearings are suitable for high speeds. The permissible speeds listed on the Dimension Tables are the values for one bearing under light load and preload.



The high speeds of the single bearings are not reached if angular contact ball bearings are mounted side by side. The permissible speeds assigned by various preloads and arrangements are shown on the right.

▼ Permissible Speeds for Various Bearing Arrangements and Preloads

Bearing Arrangements	/GL	/GM	/GH
		0.85 · n*	0.75 · n* 0.5 · n*
		0.75 · n*	0.60 · n* 0.35 · n*
		0.65 · n*	0.5 · n* 0.3 · n*
		0.65 · n*	0.5 · n* 0.3 · n*

* Permissible speeds listed on the Dimension Tables
/GL : Light load / GM : Medium load / GH : Heavy load

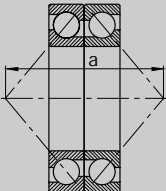
▼ Types and Characteristics of Bearing Arrangements

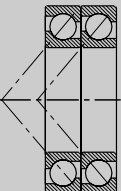
Drawing	Arrangement Type	Characteristics
	O Arrangement (DB)	<ul style="list-style-type: none"> - It can transmit radial forces as well as axial forces on both sides. - Load capacity of the moment load is big, because the distances of application points of two bearings, a, are long.
	X Arrangement (DF)	<ul style="list-style-type: none"> - It can transmit radial forces as well as axial forces on both sides. - Load capacity of the moment load is smaller, because the distances of application points of two bearings, a, are shorter than those of O Arrangement. - The permissible aligning angle is smaller than that of O Arrangement.
	T Arrangement (DT)	<ul style="list-style-type: none"> - It can transmit radial forces as well as axial forces on one side. - Axial load capacity is larger than other arrangements, because two bearings can transmit the axial forces at the same time.

KBC Angular Contact Ball Bearings

Single Row · Heat Treatment · Dynamic Load Rating · Equivalent Loads · Static Load Rating

Heat Treatment

KBC single row angular contact ball bearings are heat-treated in such a way that they can be used at operating temperatures of up to 120°C. For the bearings requiring higher operating temperatures, contact KBC.

Angular Contact Ball Bearing Arrangements

In the cases of the arrangements with two single-row angular contact ball bearings, three kinds of arrangements are possible, namely, X Arrangement (Face-to-face arrangement, DF), O Arrangement (Back-to-back arrangement, DB), T Arrangement (In-series Arrangement, DT). Characteristics of each arrangement are shown on Page 156.

Dynamic Load Rating, C, of Arranged Angular Contact Ball Bearings

With two or more angular contact ball bearings mounted side by side, the load rating for the bearing group amount to

$$C = i^{0.7} \cdot C_{\text{single bearing}}$$

Where,

C : Dynamic load rating of the bearing group
i : Number of bearings

Consequently, for bearing pairs,

$$C = 1.625 \cdot C_{\text{single bearing}}$$

Equivalent Dynamic Load

$$P = X \cdot F_r + Y \cdot F_a$$

Factors, X and Y, are determined by a contact angle and arrangement type, and their values are shown on the Table below.

Static Load Rating, C₀, of Arranged Angular Contact Ball Bearings

$$C_0 = i \cdot C_{0 \text{ single bearing}}$$

Therefore, in case of double row bearings,

$$C_0 = 2 \cdot C_{0 \text{ single bearing}}$$

Equivalent Static Load

$$P_0 = X_0 \cdot F_r + Y_0 \cdot F_a$$

The factors, X₀ and Y₀, are determined by contact angles and arrangement methods, and their values are shown below.

▼ Radial and Axial Factors of Angular Contact Ball Bearings

Nominal Contact Angle	Single Bearing, T Arrangement (In-series arrangement)						O Arrangement (Back-to-back arrangement) X Arrangement (Face-to-face arrangement)			
	e	iF _a /C ₀	F _a /F _r ≤ e		F _a /F _r > e		F _a /F _r ≤ e		F _a /F _r > e	
			X	Y	X	Y	X	Y	X	Y
15°	0.025	0.4	1	0	0.44	1.42	1	1.6	0.72	2.3
	0.04	0.42	1	0	0.44	1.36	1	1.5	0.72	2.2
	0.07	0.44	1	0	0.44	1.27	1	1.4	0.72	2.1
	0.13	0.48	1	0	0.44	1.16	1	1.3	0.72	1.9
	0.25	0.53	1	0	0.44	1.05	1	1.2	0.72	1.7
	0.50	0.56	1	0	0.44	1	1	1.1	0.72	1.6
25°		0.68	1	0	0.41	0.87	1	0.9	0.67	1.41
30°		0.80	1	0	0.39	0.76	1	0.78	0.63	1.24
40°		1.14	1	0	0.35	0.57	1	0.55	0.57	0.93

1 is assigned to l in case of single bearing T arrangement, and 2 in case of X arrangement.

KBC Angular Contact Ball Bearings

Single Row · Preload

▼ Radial and Axial Factors of Angular Contact Ball Bearings

Nominal Contact Angle	s	Single Bearing, T Arrangement (In-series arrangement)				O Arrangement(Back-to-back arrangement) , X Arrangement(Face-to-face arrangement)	
		$F_a/F_r \leq s$		$F_a/F_r > s$		X_0	Y_0
		X_0	Y_0	X_0	Y_0		
15°	1.09	1	0	0.5	0.46	1	0.92
25°	1.32	1	0	0.5	0.38	1	0.76
30°	1.52	1	0	0.5	0.33	1	0.66
40°	1.92	1	0	0.5	0.26	1	0.52

Preloads of Arranged Bearings

The average preloads of the high precision angular contact ball bearings of Class P5 or higher, used for main shaft of tooling machines, and others, are shown below. In general, the light-load bearings are used for main shafts of spindle or machining centers, and the medium or heavy-load bearings for main shafts of lathe or others.

▼ Preloads on Arranged Bearings

Bore Reference Number	SM70C			SM70E		
	GL Preloads[N]	GM	GH	GL	GM	GH
00	35	100	200	55	160	330
01	35	110	220	60	180	360
02	40	120	250	70	210	410
03	50	140	290	80	240	480
04	65	200	400	110	330	660
05	75	220	440	120	370	730
06	95	290	570	150	460	930
07	110	330	650	180	540	1100
08	120	350	690	190	570	1150
09	160	460	930	250	760	1500
10	160	490	980	270	800	1600
11	230	680	1350	370	1100	2250
12	240	710	1400	390	1150	2300
13	240	720	1450	390	1150	2350
14	300	910	1800	500	1500	3050
15	320	950	1900	520	1550	3100
16	390	1150	2350	640	1950	3850
17	400	1200	2400	650	1950	3950
18	480	1450	2900	780	2350	4700
19	490	1450	2950	800	2400	4800
20	500	1500	3000	820	2450	4900

KBC Angular Contact Ball Bearings

Single Row · Abutment Dimensions · Prefixes · Suffixes

Abutment Dimensions

The bearing rings should closely fit the shaft or housing shoulder, they must not be allowed to foul the shoulder fillet radius. Consequently, the maximum fillet radius r_g of the mating part must be smaller than the minimum corner r_{min} of the angular contact ball bearing.

The shoulder of the mating parts must be so high that even with maximum bearing corner, there is an adequate abutment surface. The maximum fillet radius R , the minimum diameters of abutment shoulders of shaft, D_s , and the maximum diameters of abutment shoulders of housing, d_h , are shown on the Dimension Tables.

Prefixes

- BS** For high speeds. Sealed Type
- SM** Design for high speeds
- SA** For special dimensions

Suffixes

- B** Contact angle of 40°
- C** Contact angle of 15°
- P** High-tension machined brass cage
- PC** Glass-fiber reinforced polyamide 66 cage
- PH** Penol resin base cage with multi fabric layers
- DB** Arrangement O
(Back-to-back arrangement)
- DF** Arrangement X
(Face-to-face arrangement)
- DT** Arrangement T
(In-series arrangement)
- /GL** Light preload
- /GM** Medium preload
- /GH** Heavy preload

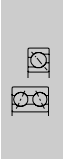

KBC Angular Contact Ball Bearings

Single Row · Normal Series, SM Series, BS Series

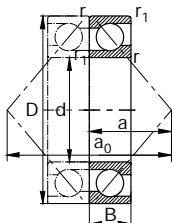

Normal Series

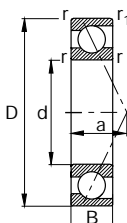

SM Series

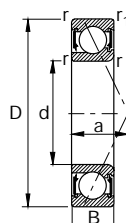

BS Series

Shaft	Dimensions					Distance of Application			Abutment Dimensions			Smaller Sider Surface								
	d	D	B	r	r ₁	Single Bearing a	Arranged OArranged a ₀	Bearing a ₀	Larger Side Surface D _s	min	d _h	max	R	max	D _{s1}	min	d _{h1}	max	R ₁	max
	mm																			
17	17	40	12	0.6	0.3	17.1	34.3	10.3	22	35	0.6	19.5	37.5	0.3						
	17	47	23	1	0.6	19.5	39	11	23	41	1	22	42	0.6						
20	20	42	12	0.6	0.3	10.2	20.3	3.7	25	37	0.6	24	39.5	0.3						
	20	47	14	1	0.6	20.1	40.2	12.2	26	41	1	25	42	0.6						
	20	52	15	1.1	0.6	21.6	43.1	13.1	27	45	1	25	47	0.6						
25	25	47	12	0.6	0.3	10.8	21.6	2.4	30	42	0.6	29	44.5	0.3						
	25	52	15	1	0.6	22.5	45.1	15.1	31	46	1	30	47	0.6						
	25	62	17	1.1	0.6	25.5	51	17	32	55	1	30	57	0.6						
	25	80	21	1.5	0.6	25.7			35	70	1.5									
30	30	55	13	1	0.6	12.2	24.4	1.6	36	49	1	34	50	0.6						
	30	55	17	1 ¹⁾	0.5	14.2			34	49	1									
	30	62	16	1	0.6	26	51.9	19.9	36	56	1	35	57	0.6						
35	35	62	18.5	1 ¹⁾	0.5	15.7			39	56	1									
45	45	100	25	1.5	1.1	40.8	81.6	31.6	54	91	1.5	51	94	1						
50	50	110	27	2	1.1	44.8	89.5	35.5	60	100	2	56	104	1						

1) A chamfer on one side of inner ring has its own dimensions.
 2) The shape of inner ring tracks of normal type bearings listed above is same as that of SM Series bearings.

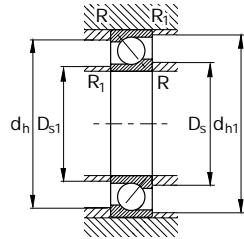

Rating Load		Static		Arranged Bearing		Bearing		Permissible Speed		Standards		Weight	
Single	Bearing	C ₀		Dynamic	Bearing	Dynamic	Static	Single	Oil	Grease	Oil	Bearing	≈
C		N	kgf	C	C	C	C ₀	Lubrication	Lubrication	Lubrication	Lubrication	Bearing	kg
N	kgf	N	kgf	N	kgf	N	kgf	min ⁻¹				KBC	
9950	1010	5850	565	16100	1650	11000	1130	14000	19000	11000	15000	7203B	0.07
14800	1510	8000	820	24000	2450	16000	1640	13000	17000	11000	14000	7303B	0.12
11000	1130	6550	665	18000	1840	12000	1220	26000	35000	20000	30000	SM7004CP5	0.07
13300	1360	7650	780	21600	2210	15300	1560	12000	16000	9500	13000	7204B	0.11
17300	1770	9650	985	28200	2870	19300	1970	11000	15000	9000	12000	7304B	0.15
14600	1490	9150	930	21000	2140	14800	1510	22000	30000	18000	26000	SM7005CP5	0.09
14800	1510	9400	960	24000	2450	18800	1920	10000	14000	8500	11000	7205B	0.13
42700	4350	23400	2380					7000	10000			7405A	0.51
15100	1540	10300	1050	24600	2510	19000	2090	19000	26000	15000	22000	SM7006CP5	0.12
15100	1540	10300	1050					19000				BS30-PHAUU	0.14
20500	2090	13500	1380	33500	3400	27000	2760	8500	12000	7100	9500	7206B	0.2
19100	1950	13700	1390					17100				BS35-PHAUU	0.19
58500	5950	40000	4100	95000	9650	80500	8200	5600	7500	4500	6000	7309B²⁾	0.86
68000	6950	48000	4900	111000	11300	96000	9800	5000	6700	4000	5600	7310B²⁾	1.11

Bearings of different designs can be custom-made on request.

KBC Angular Contact Ball Bearings

Single Row · SA Series

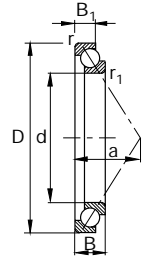

SA Series

Shaft	Dimensions						Distance of Application Points $a \approx$	Abutment Dimensions			
	d	D	B	B_1	r_{\min}	r_1_{\min}		$D_{\frac{3}{4}\min}$	$d_{h\max}$	R_{\max}	R_1_{\max}
	mm										
230	230	300	33	24	2.1	1.1	93.3	245	285	2	1
	230	300	35	25	2.1	1.1	94.2	245	285	2	1
250	250	330	38	27	2.1	1	103	265	315	2	1
260	260	340	38	30	2.2 ¹⁾	1.1	105.9	275	325	2	1
289	289	355	33	24	2	1	109.7	305	340	2	1
300	300	370	33	28.5	2.1	1.1	113.5	315	355	2	1
	300	372	36	28	3.5 ¹⁾	1.5	115.2	315	357	3	1.5

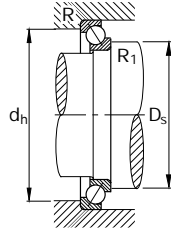

Rating Load

Dynamic
C

C_0

kgf

Static
C

C_0

kgf

Standards

Bearing

KBC

Weight

≈

kg

165000	16900	228000	28600
165000	16900	228000	28600
205000	20900	281000	28600
212000	21500	299000	30400
182000	18600	279000	28500
188000	19200	292000	29700
217000	22100	322000	32850

SA0300h
SA0300
SA0330
SA0340
SA0355
SA0370
SA0372

KBC Angular Contact Ball Bearings

Double Row



KBC Angular Contact Ball Bearings

Double Row · Basic Designs · Tolerances · Bearing Clearances · Cages · Heat Treatment · Sealed Bearings

The structure of the double row angular contact ball bearings corresponds to a pair of single row angular contact ball bearing in O arrangement, and it has a solid outer ring but its inner ring is either solid or divided into two parts. This bearing can accommodate high radial loads and thrust loads in both directions, and it is particularly suitable for bearing arrangements requiring a rigid axial guidance.

Basic Designs

KBC supplies the double row angular contact ball bearings of special dimensions on request to meet the special demands of customers. Basic designs can be structurally divided into a few groups as follows.

SDA9 Series bearings have special dimensions, and each of their outer and inner rings are unitized. Most of them are produced in sealed type, and some come with snap rings. They have the contact angles of either 20° or 25°.

SDA0 Series bearings are also the special dimension bearings with unitized outer rings, but their inner rings are split. There are two types, flanged or snap ring types, and contact angles of 20°, 30°, or 35° are available.

Other bearings of customers' own specifications can be supplied on request.

Tolerances

Basic double row angular contact ball bearings have normal tolerances.

For exact tolerances, contact KBC.

Tolerances: Refer to Table 7-2 Tolerances of Radial Bearings on Page 68.

Bearing Clearances

Double row angular contact ball bearings requiring special dimensions can be made as required clearances on request, and the axial clearances are listed on the Dimension Tables.

Cages

Most double row angular contact ball bearings are

made from glass-fiber reinforced polyamide 66(Suffix PC). These cages can be used at operating temperatures of up to 120°C over extended periods. If the bearings are lubricated with oil, any additives contained in the oil may reduce the cage

service life. Also, aged oil may reduce the cage life at higher temperatures; therefore, the oil change intervals have to be strictly observed.

Other customized cages can be made on request.

Heat Treatment

KBC double row angular contact ball bearings are heat-treated in such a way that they can be used at operating temperatures of up to 120°C, and special bearings needed to be operated at the temperatures above 120°C are specially heat-treated accordingly.

If bearings with glass-fiber reinforced polyamide 66 cage are used, the temperature limits of application of the cage material have to be observed.

With sealed bearings, the valid limits of application must be observed also.

Sealed Bearings

In addition to open double row angular contact ball bearings, KBC also supplies, as basic designs, angular contact ball bearings with sealed both sides. SDA9 Series bearings with unitized inner ring are usually sealed with contact type seals, and they are filled at the manufacturer's plant with a high-quality grease tested to KBC specifications.



KBC Angular Contact Ball Bearings

Double Row · Equivalent Loads

Equivalent Dynamic Loads

The formulae for the equivalent load depend on the contact angle of the bearings.

Angular contact ball bearings with a contact angle of $\alpha = 20^\circ$

$$P = F_r + 1.09 \cdot F_a \quad : \quad \frac{F_a}{F_r} \leq 0.57 \text{ for}$$

$$P = 0.67 \cdot F_r + 1.63 \cdot F_a \quad : \quad \frac{F_a}{F_r} > 0.57 \text{ for}$$

Angular contact ball bearings with a contact angle of $\alpha = 25^\circ$

$$P = F_r + 0.92 \cdot F_a \quad : \quad \frac{F_a}{F_r} \leq 0.68 \text{ for}$$

$$P = 0.67 \cdot F_r + 1.41 \cdot F_a \quad : \quad \frac{F_a}{F_r} > 0.68 \text{ for}$$

Angular contact ball bearings with a contact angle of $\alpha = 30^\circ$

$$P = F_r + 0.78 \cdot F_a \quad : \quad \frac{F_a}{F_r} \leq 0.80 \text{ for}$$

$$P = 0.63 \cdot F_r + 1.24 \cdot F_a \quad : \quad \frac{F_a}{F_r} > 0.80 \text{ for}$$

Angular contact ball bearings with a contact angle of $\alpha = 35^\circ$

$$P = F_r + 0.66 \cdot F_a \quad : \quad \frac{F_a}{F_r} \leq 0.95 \text{ for}$$

$$P = 0.6 \cdot F_r + 1.07 \cdot F_a \quad : \quad \frac{F_a}{F_r} > 0.95 \text{ for}$$

Equivalent Static Load

The radial factor is 1; the thrust factors depend on the contact angle.

Angular contact ball bearings with a contact angle of $\alpha = 20^\circ$

$$P_0 = F_r + 0.84 \cdot F_a$$

Angular contact ball bearings with a contact angle of $\alpha = 25^\circ$

$$P_0 = F_r + 0.76 \cdot F_a$$

Angular contact ball bearings with a contact angle of $\alpha = 30^\circ$

$$P_0 = F_r + 0.66 \cdot F_a$$

Angular contact ball bearings with a contact angle of $\alpha = 35^\circ$

$$P_0 = F_r + 0.58 \cdot F_a$$

KBC Angular Contact Ball Bearings

Double Row · Abutment Dimensions · Prefixes

Abutment Dimensions

The bearing rings should closely fit the shaft or housing shoulder, and they must not be allowed to foul the shoulder fillet radius. Consequently, the maximum fillet radius r_g of the mating part must be smaller than the minimum corner r_{min} of the angular contact ball bearing.

The shoulder of the mating parts must be so high that even with maximum bearing corner, there is an adequate abutment surface. The maximum fillet radius R , the minimum diameters of abutment shoulders of shaft, D_s , and the maximum diameters of abutment shoulders of housing, d_h , are shown on the Dimension Tables.

Prefixes

SDA For special dimensions

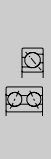

KBC Angular Contact Ball Bearings

Double Row · SDA0 Series

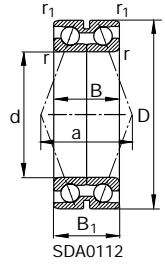
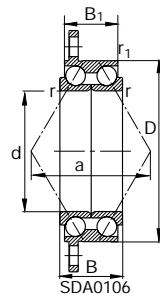
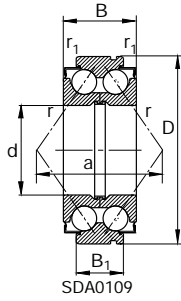
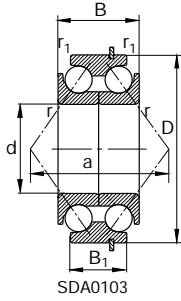

Shaft	Dimensions						Distance of application $a \approx$	Axial Clearances		Contact α deg
	d mm	D	B	B ₁	r min	r ₁ min		min	max	
38	38	80	34.5	23.9	0.5	0.3	58.3	0.015	0.036	35
43	43	90	35	22.66	0.5	0.3	60.9	0.015	0.045	35
52	52	78	27.2	23	1.1	0.7	51	0	0.02	30
69	69	92	24	24	1.1	1	41.3	0.05	0.08	20
165	165	210	52	47.5	1.1	1.1	82.5	0.1	0.2	30
320	320	456	118.2	217	3.1		282.3	0.12	0.15	30

KBC Tapered Roller Bearings

Single Row



KBC Tapered Roller Bearings

Single Row • Standards • Basic Designs • Codes • Alignment

Standards

Tapered roller bearings in metric dimensions ISO 355 and KS B 2027

Information on the availability of special tapered roller bearings in both metric and inch dimensions, with or without roller and cage assembly on inner ring, and others, can be supplied on request.

Basic Designs

Tapered roller bearings can transmit radial and axial forces, and since they are split type bearings, their inner and outer rings can be mounted separately. And tapered roller bearings in metric dimensions can be divided into three groups depending on contact angles; Normal contact angles (Smaller than contact angle of 17°, no codes), medium contact angles (About 20°, Code C), and large contact angles (About 28°, code D).

Alignment

The modified line contact between the tapered rollers and the raceways eliminates edge stressing and allows the tapered roller bearings to align.

For single row tapered roller bearings, a maximum angular alignment of 4 angular minutes is admissible at a load ratio $P/C \leq 0.2$. If higher loads or greater misalignments have to be accommodated, please contact KBC.

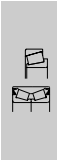

Codes

There are two codes for tapered roller bearings in metric dimensions listed in the Dimension Tables. The codes listed by dimensions are shown on Page 58, and the ones by contact angles are shown below.

Tapered roller bearings in inch dimensions according to AFBMA Specifications are shown on Page 60.

▼ Tapered Roller Bearing Codes by Contact Angles

Examples: T 2 F B 020

Codes for Tapered Roller Bearings

Bearing Bore (mm)

Contact Angle Range

Angle Series	Contact Angle Range
	over To
1	Reserved
2	10° ... 13° 52'
3	13° 52' ... 15° 59'
4	15° 59' ... 18° 55'
5	18° 55' ... 23°
6	23° ... 27°
7	27° ... 30°

Ratio of Outside Diameter to Bore

Diameter Series $\frac{D}{d} 0.77$

	Over	To
A	Reserved	
B	3.40 ...	3.80
C	3.80 ...	4.40
D	4.40 ...	4.70
E	4.70 ...	5.00
F	5.00 ...	5.60
G	5.60 ...	7.00

Ratio of Bearing Width to Cross Section Height

Width Series $\frac{T}{(D - d) 0.95}$

	Over	To
A	Reserved	
B	0.50 ...	0.68
C	0.68 ...	0.80
D	0.80 ...	0.88
E	0.88 ...	1.00

KBC Tapered Roller Bearings

Single Row · Tolerances · Bearing Clearances · Speeds Suitability · Heat Treatment · Cages · Equivalent Loads · Axial Loads

Tolerances

Tapered roller bearings of the basic designs in metric dimensions have a normal tolerance, and the inch series tapered roller bearings have the tolerances of AFBMA Class 4.

The bearings with an increased precision can be supplied on request.

Tolerances: Refer to Table 7-3 Tolerances of Tapered Roller Bearings in Metric Dimensions on Page 74.

Refer to Table 7-4 Tolerances of Tapered Roller Bearings in inch Dimensions on Page 78.

Bearing Clearances

The axial clearance of tapered roller bearings is set on mounting by adjusting it against another bearing.

Speed Suitability

The permissible speeds for both grease and oil lubrication are shown on the Dimension Tables. In case of oil lubrication, the permissible speeds shown on the Dimension Tables are the values assuming oil sump lubrication.

Depending on various lubricating methods, they can be operated at a higher speed.

Heat Treatment

KBC tapered roller bearings are heat-treated in such a way that they can be used at operating temperatures of up to 120°C. For the bearings required to be used above that temperature, please contact KBC.

Cages

KBC tapered roller bearings have pressed steel cages. The cages in some bearings slightly project laterally; this must be taken into account for mounting(Refer to abutment dimensions in the Dimension Tables.)

Equivalent Dynamic Load

$$P = F_r \quad : \text{for } \frac{F_a}{F_r} \leq e$$

$$P = 0.4 \cdot F_r + Y \cdot F_a \quad : \text{for } \frac{F_a}{F_r} > e$$

If single row tapered roller bearings are used, the axial reaction forces have to be taken into account(Refer to the Table on Page 35). Y and e are indicated in the Dimension Tables.

Equivalent Static Load

$$P_0 = F_r \quad : \text{for } \frac{F_a}{F_r} \leq \frac{1}{2 \cdot Y_0}$$

$$P_0 = 0.5 \cdot F_r + Y_0 \cdot F_a \quad : \text{for } \frac{F_a}{F_r} > \frac{1}{2 \cdot Y_0}$$

If single row tapered roller bearings are used, the axial reaction forces have to be taken into account(Refer to the Table on Page 35). Y₀ is indicated in the Dimension Tables.

Determining the Axial Loads Acting on a Single Bearing

Due to the inclination of the raceways, a radial load induces axial reaction forces in tapered roller bearings, which have to be taken into account in the determination of the equivalent load.

For details, refer to Page 34 on load calculation of angular contact ball bearings and tapered roller bearings.

KBC Tapered Roller Bearings

Single Row · Abutment Dimensions · Prefixes · Suffixes

Abutment Dimensions

The cups and cones should closely fit the shaft or housing shoulder; they must not be allowed to foul the shoulder fillet radius. Consequently, the maximum fillet radius of the mating part must be smaller than the minimum corner of the tapered roller bearing.

The shoulder of the mating parts must be so high that even with maximum bearing corner, there is an adequate abutment surface area.

The abutment shoulder diameters are indicated in the Dimension Tables.

The cages in some bearings slightly project laterally; this must be taken into account for mounting. The abutment dimensions, a_1 and a_2 , are indicated in the Dimension Tables.

Prefixes

TR Changed basic dimensions(Bore, outer diameter, width) from standards.

Suffixes

- A** Changed internal design from standards
- C** Medium contact angles(About 17~24°)
- D** Increased contact angles(About 24~32°)
- DX** Inner ring width and mounting width differ from those of a bearing with contact angle D.
- g** Bearing made of carburized steel
- HL** Special heat-treatment for long life
- J** Designs adapted to ISO standards
- F** Changed bore diameter from standards
- F2** Changed outer diameter from standards
- h** Changed width from standards

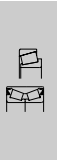

KBC Tapered Roller Bearings

Single Row

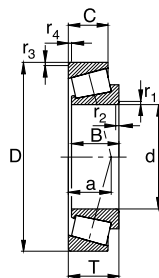

Shaft	Dimensions					Distance of Application Points		Abutment Dimensions								
	d	D	B	C	T	r_1, r_2 min	r_3, r_4 min	a ≈	D_1 max	D_2 min	D_3 min	D_3 max	D_4 min	a_1 min	a_2 min	
	mm															
17	17	40	12	11	13.25	1	1	9.8	23	23	34	34	38	2	2	
20	20	42	15	12	15	0.6	0.6	10.6	24	28	35	37	40	2	3	
	20	47	14	12	15.25	1	1	11.2	27	29	40	41	44	2	3	
	20	47	18	15	19.25	1	1	12.4	26	29	38	41	44	2	4	
	20	47	18	15	19.25	1	1	12.4	26	29	38	41	44	2	4	
	20	52	15	13	16.25	1.5	1.5	11.4	27	31	44	44	48	2	3	
	20	52	16	12	16.25	1.5	1.5	13.7	27	32	42	44	50	2	3	
	20	52	21	18	22.25	1.5	1.5	13.9	26	33	43	48	42	3	4	
24	24	41	11.2	8.6	12.5	0.6	0.6	10.8	27	31	35	36	40	2	4	
25	25	47	15	11.5	15	0.6	0.6	11.8	30	33	40	42	45	3	3.5	
	25	47	17	14	17	0.6	0.6	10.9	29	33	41	42	45	3	3	
	25	52	15	13	16.25	1	1	12.7	31	34	44	46	49	2	3	
	25	52	18	15	19.25	1	1	13.7	30	34	42	46	49	2	4	
	25	52	18	15	19.25	1	1	15.8	30	34	40	46	50	2	4	
	25	52	22	18	22	1	1	14.1	29	34	43	46	50	4	4	
	25	62	17	15	18.25	1.5	1.5	19.8	34	36	54	54	58	2	3	
	25	62	17	14	18.25	1.5	1.5	16.4	35	36	49	53	59	3	4	
	25	62	17	13	18.25	1.5	1.5	19.8	33	39	46	53	59	3	5	
	25	62	18.45	13	19.7	1.5	1.5	19.8	33	39	46	53	59	3	5	
	25	62	24	20	25.25	1.5	1.5	15.9	32	38	51	53	58	3	5	
	28	28	50.292	18.724	10.668	14.224	3.6	1.8	10.8	33	37	44	44	48	3	4
28		52	16	12	16	1	1	12.5	33	37	44	46	50	3	4	
28		52	18.5	12	16	3.6	1.8	12.5	33	37	44	46	50	3	4	
28		57	17	13	17	1.5	1.5	13.7	34	38	49	50	55	3	3	
28		58	16	12	17.25	1	1	16.9	34	37	48	52	55	2	3	
28		58	19	16	20.25	1	1	14	34	37	49	52	56	2	4	
28		62	18	14	18	1	1	15	40	44	54	56	60	4	4	
28		62	18	15.75	19.75	1	1	15.5	36	42	51	54	59	4	6	
28		63	21.25	17.7	22.25	1.5	1.5	15.4	36	40	53	54	60	3	4	
28		63	22.25	17.7	22.25	1.5	1.5	15.3	36	40	53	54	60	3	4	
28		68	18	14	19.75	1.5	1.5	17.4	38	39	57	59	64	2	4.5	
28		68	18	16	19.75	2	2	14.7	39	41	57	59	63	2	3	
30		30	55	17	13	17	1	1	13.5	35	39	47	49	53	3	4

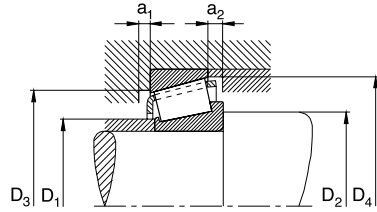

Load Rating - Factor							Permissible Speed		Standards		Weight
Dynamic C	e	Y	Static C ₀		Y ₀	Grease Lubrication	Oil Lubrication	Bearings	ISO 355 KS B 2027	≈	
N	kgf		N	kgf		min ⁻¹		KBC		kg	
20700	2110	0.35	1.7	20600	2100	0.96	9500	13000	30203J	T2DB017	0.079
25800	2630	0.37	1.6	28300	2890	0.88	9000	12000	32004XJ	T3CC020	0.097
29000	2960	0.35	1.7	29800	3040	0.96	8000	11000	30204J	T2DB020	0.127
37000	3770	0.35	1.7	40000	4080	0.95	8500	11000	32204		0.16
37000	3770	0.33	1.8	40000	4080	1	8500	11000	32204J	T2DD020	0.16
36000	3670	0.3	2	34500	3520	1.1	7500	10000	30304J	T2FB020	0.171
32500	3310	0.55	1.1	32000	3260	1.1	7500	10000	30304C		0.167
45000	4590	0.3	2	48000	4890	1.1	8000	11000	32304J	T2FD020	0.24
13000	1330	0.5	1.2	15000	1530	0.66	8000	11000	TR244113		0.11
27500	2800	0.43	1.4	34200	3490	0.77	8000	11000	32005XJ	T4CC025	0.116
31500	3210	0.29	2.1	40500	4130	1.1	8000	11000	33005J	T2CE025	0.131
32000	3260	0.38	1.6	35000	3570	0.88	7100	10000	30205J	T3CC025	0.156
38000	3870	0.39	1.5	44000	4490	0.85	7500	10000	32205		0.186
35000	3570	0.53	1.1	42000	4280	0.62	7100	9500	32205C		0.189
47000	4790	0.39	1.7	57000	5810	0.94	7500	10000	33205J	T2DE025	0.221
47500	4840	0.3	2	46500	4740	1.1	6300	8500	30305J	T2FD025	0.269
42500	4330	0.55	1.1	45000	4590	0.6	6000	8500	30305C		0.275
38000	3870	0.81	0.74	41500	4230	0.41	6000	8000	30305D		0.254
39000	3980	0.81	0.74	41500	4230	0.41	6000	8000	30305DX		0.262
60000	6120	0.3	2	64500	6580	1.1	6300	8500	32305J	T2FD025	0.375
27400	2790	0.37	1.6	34600	3530	0.89	7100	9500	TR285014		0.122
33000	3360	0.43	1.4	40500	4130	0.77	7100	9500	320/28XJ	T4CC028	0.146
33900	3460	0.43	1.4	40600	4140	0.77	7100	9500	TR285216		0.149
42000	4280	0.43	1.4	48800	4980	0.77	6300	8500	TR285717		0.202
36500	3720	0.64	0.94	41000	4180	0.52	6300	8500	302/28C		0.199
44500	4540	0.37	1.6	52000	5300	0.89	6300	9000	322/28		0.242
42500	4330	0.45	1.3	56000	5710	0.73	6000	8000	32007XJF1		0.274
48600	4960	0.49	1.3	56600	5770	0.68	6000	8000	TR286220		0.282
59800	6100	0.33	1.8	65700	6700	0.99	6000	8000	TR286322		0.295
59800	6100	0.33	1.8	65700	6700	0.99	6000	8000	TR286322h		0.299
52500	5350	0.52	1.2	53500	5460	0.64	5600	7500	303/28C		0.335
53000	5400	0.32	1.9	53500	5460	1	5600	7500	TR286819		0.336
35500	3620	0.43	1.4	44500	4540	0.77	6700	9000	32006XJ	T4CC030	0.172

Bearings of different designs can be custom-made on request.

KBC Tapered Roller Bearings

Single Row

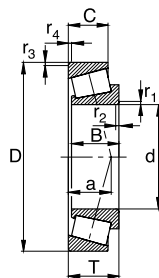

Shaft	Dimensions					Distance of Application Points		Abutment Dimensions							
	d	D	B	C	T	r_1, r_2 min	r_3, r_4 min	a ≈	D_1 max	D_2 min	D_3 min	D_3 max	D_4 min	a_1 min	a_2 min
mm															
30	30	62	16	14	17.25	1	1	13.8	37	39	52	56	58	2	3
	30	62	17	14	17.25	1.5	1.5	13.2	37	40	53	54	59	3	3
	30	62	17.7	13.3	17.7	1	1	16.2	37	43	50	52	59	4	3
	30	62	20	17	21.25	1	1	15.4	36	39	51	56	59	2	4
	30	62	20	16	21.25	1	1	18.1	35	39	48	56	59	2	5
	30	72	19	16	20.75	1.5	1.5	15.3	40	41	62	63	67	3	4.5
	30	72	18.923	15.875	19	1.5	1.5	15.3	40	41	62	63	67	3	3
	30	72	19	14	20.75	1.5	1.5	18.3	38	41	59	63	68	3	6.5
	30	72	19	14	20.75	1.5	1.5	23.3	39	39	56	63	68	3	6.5
	30	72	27	23	28.75	1.5	1.5	19.3	38	43	59	62	67	3	5.5
32	32	65	17	15	18.25	1	1	14.7	39	41	56	59	61	3	3
	32	65	21	18	22.25	1	1	15.8	38	41	54	59	61	3	4
35	35	62	18	14	18	1	1	15	40	44	54	56	60	4	4
	35	72	17	15	18.25	1.5	1.5	15	43	46	62	63	68	3	3
	35	72	23	18	24.25	1.5	1.5	20.6	42	46	58	63	69	3	6
	35	72	23	19	24.25	1.5	1.5	17.9	42	46	61	63	68	3	5
	35	80	21	18	22.75	2	1.5	16.7	45	49	68	73	75	2	6.5
	35	80	21	18	22.75	2	1.5	16.8	46	50	69	72	76	3	6.5
	35	80	21	16	22.75	2	1.5	20.3	47	44	65	71	75	3	6.5
	35	80	21	15	22.75	2	1.5	25.8	51	44	62	71	77	3	7.5
	35	80	31	25	32.75	2	1.5	21.1	49	43	66	71	75	3	7.5
	35	80	31	24	32.75	2	1.5	23.7	49	44	61	71	75	3	8.5
40	40	68	19	14.5	19	1	1	17.4	45	49	60	62	66	4	4.5
	40	68	19	14.5	19	1	1	17.4	47	51	58	60	66	2	5
	40	72	15	11.5	15.5	1	1	14.1	46	50	63	64	68	3	3.5
	40	75	26	20.5	26	1.5	1.5	18.4	49	54	64	66	77	2.5	6
	40	80	18	16	19.75	1.5	1.5	16.9	48	51	69	71	75	3	3.5
	40	80	23	19	24.75	1.5	1.5	19	48	51	68	71	76	3	5.5
	40	90	23	20	25.25	2	1.5	19.4	52	52	76	81	84	3	5
	40	90	23	17	25.25	2	2	28.9	48	57	70	79	87	3	8
	40	90	23	17	25.25	2	1.5	29.8	50	56	70	81	88	3	8
	40	90	33	27	35.25	2	1.5	23.4	50	54	73	81	84	3	8
45	45	75	20	15.5	20	1	1	16.4	51	54	67	69	73	4	4.5
	45	85	19	16	20.75	1.5	1.5	18.2	53	56	74	76	81	3	4.5
	45	85	23	19	24.75	1.5	1.5	20.1	53	56	73	76	81	3	5.5
	45	95	35	30	36	2.5	2.5	23.8	56	63	78	80	90	4	5.5

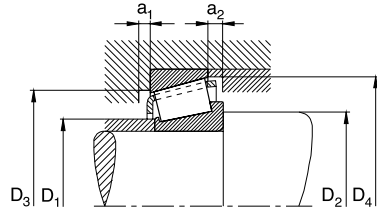

Load Rating · Factor							Permissible Speed		Standards		Weight
Dynamic C	e	Y	Static C ₀		Y ₀	Grease Lubrication	Oil Lubrication	Bearings	ISO 355 KS B 2027	≈	
			N	kgf							N
43000	4380	0.38	1.6	47500	4840	0.88	6000	8000	30206J	T3DB030	0.237
45500	4640	0.36	1.7	32000	3260	0.92	6000	8000	TR306217		0.237
42500	4330	0.55	1.1	32000	3260	0.6	6000	8000	TR306217C		0.225
55500	5660	0.37	1.6	65500	6680	0.88	6000	8500	32206J	T3DC030	0.296
50500	5150	0.55	1.1	59000	6020	0.6	5600	7500	32206C		0.293
60000	6120	0.32	1.9	61000	6220	1	5300	7500	30306J	T2FB030	0.402
59000	6020	0.32	1.9	61000	6220	1	5300	7500	30306Jh		0.385
57500	5860	0.55	1.1	56500	5760	0.6	5300	7100	30306C		0.382
52000	5300	0.83	0.73	56500	5760	0.4	5000	7100	30306DJ	T7FB030	0.398
75500	7700	0.32	1.9	84000	8570	1	5600	7500	32306J	T2FD030	0.569
47500	4840	0.37	1.6	54000	5510	0.88	5600	8000	302/32		0.276
55000	5610	0.37	1.6	65500	6680	0.88	6000	8000	322/32		0.335
42500	4330	0.45	1.3	56000	5710	0.73	5600	8000	32007XJ	T4CC035	0.229
55000	5610	0.37	1.6	61000	6220	0.88	5300	7100	30207J	T3DB035	0.339
59500	6070	0.55	1.1	71500	7290	0.6	5000	6700	32207C		0.441
70500	7190	0.38	1.6	84000	8570	0.88	5300	7100	32207J	T3DC035	0.455
77000	7850	0.32	1.9	80000	8160	1	4800	6300	30307J	T2FB035	0.52
67800	6910	0.67	0.9	68100	6940	0.49	4800	6300	30307		0.52
68500	6980	0.55	1.1	71500	7290	0.6	4800	6300	30307C		0.517
63000	6420	0.83	0.73	69500	7090	0.4	4300	6000	30307DJ	T7FB035	0.517
96500	9840	0.32	1.9	111000	11300	1	5000	6700	32307J	T2FE035	0.763
87500	8920	0.47	1.3	110000	11200	0.7	4800	6300	32307C		0.782
51500	5250	0.38	1.6	67000	6830	0.87	5300	7100	32008XJ	T3CD040	0.279
50500	5150	0.38	1.6	67000	6830	0.87	5300	7100	32008XJh		0.334
48000	4890	0.4	1.5	54000	5510	0.82	5000	6800	TR407215		0.252
80000	8160	0.35	1.7	104000	10600	0.93	5000	6800	33108		0.507
64000	6530	0.38	1.6	71000	7240	0.88	4800	6300	30208J	T3DB040	0.436
76500	7800	0.38	1.6	91500	9330	0.88	4800	6300	32208J	T3DC040	0.547
96000	9790	0.35	1.7	109000	11100	0.96	4300	5600	30308J	T2FB040	0.756
81500	8310	0.81	0.74	92000	9380	0.41	3800	5300	30308D		0.712
81500	8310	0.83	0.73	92000	9380	0.4	3800	5300	30308DJ	T7FB040	0.726
118000	12000	0.35	1.7	147000	15000	0.96	4300	6000	32308J	T2FD040	1.05
57000	5810	0.39	1.5	78000	7950	0.84	4500	6300	32009XJ	T3CC045	0.353
70500	7190	0.41	1.5	82500	8410	0.81	4300	6000	30209J	T3DB045	0.487
79000	8090	0.41	1.5	95500	9740	0.81	4300	6000	32209J	T3DC045	0.601
138000	14100	0.32	1.8	172000	17500	1	4000	5600	TR459536		1.217

Bearings of different designs can be custom-made on request.

KBC Tapered Roller Bearings

Single Row

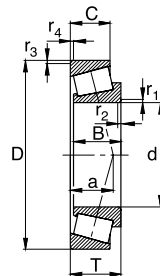

Shaft	Dimensions					Abutment Dimensions										
	d	D	B	C	T	r_1, r_2 min	r_3, r_4 min	a ≈	D_1 max	D_2 min	D_3 min	D_3 max	D_4 min	a_1 min	a_2 min	
	mm															
45	45	100	25	22	27.25	2	1.5	21.1	58	57	86	91	94	3	5	
	45	100	25	18	27.25	2	1.5	31.8	55	60	78	91	96	3	9	
	45	100	25	18	27.25	2	1.5	31.5	57	61	79	91	97	3	9	
	45	100	36	30	38.25	2	1.5	25	56	59	82	91	95	3	8	
50	50	80	20	15.5	20	1	1	17.6	56	59	71	74	78	4	4.5	
	50	90	20	17	21.75	1.5	1.5	19.6	58	61	79	81	87	3	4.5	
	50	90	23	19	24.75	1.5	1.5	21	57	61	78	81	87	3	5.5	
	50	110	27	23	29.25	2.5	2	23	65	65	95	100	104	3	6	
	50	110	27	19	29.25	2.5	2	34.4	62	70	87	100	106	3	10	
	50	110	27	19	29.25	2.5	2	34.2	62	70	87	100	106	3	10	
	50	110	40	33	42.25	2.5	2	27.9	62	68	91	100	104	3	9	
	50	114.3	44.45	34.925	44.45	3.5	3.3	32.1	62	75	88	94	108	3	9	
	55	55	90	23	17.5	23	1.5	1.5	19.7	62	66	80	81	88	4	5.5
		55	100	21	18	22.75	2	1.5	21.2	64	67	89	91	96	4	4.5
55		100	25	21	26.75	2	1.5	22.7	63	67	87	91	97	4	5.5	
55		100	31	24.5	32	2	2	24.9	65	72	85	90	97	4	8	
55		120	29	25	31.5	2.5	2	25.1	71	70	104	110	113	4	6.5	
55		120	29	21	31.5	2.5	2	38.1	67	75	94	110	115	4	10.5	
55		120	43	35	45.5	2.5	2	30.9	67	73	99	110	113	4	10.5	
60		60	95	23	17.5	23	1.5	1.5	20.9	66	71	85	86	93	4	5.5
	60	95	27	21	27	1.5	1.5	20	66	71	85	86	93	5	6	
	60	110	22	19	23.75	2	1.5	22	69	72	96	101	105	4	4.5	
	60	110	28	24	29.75	2	1.5	24.6	68	72	95	101	106	4	5.5	
	60	130	31	26	33.5	3	2.5	27.1	77	78	112	118	122	4	7.5	
	60	130	31	22	33.5	3	2.5	40.7	74	84	103	118	125	4	11.5	
	60	130	46	37	48.5	3	2.5	32.7	74	81	107	118	122	4	11.5	
	65	65	100	26	21	26	1.5	1.5	21.8	72	74	89	91	96	5	6
65		120	23	20	24.75	2	1.5	24.4	78	77	106	111	115	4	4.5	
65		120	31	27	32.75	2	1.5	27.3	75	77	104	111	117	4	5.5	
65		120	31	27	32.75	2	1.5	27.2	75	77	104	111	117	4	5.5	
65		130	48	39	51	3.5	3.5	34.2	77	90	106	111	120	4	11.5	
65		140	33	28	36	3	2.5	29.4	83	83	121	128	132	4	8	
65		140	33	23	36	3	2.5	43.6	80	89	111	128	134	4	13	
65		140	48	39	51	3	2.5	34.4	80	86	116	128	132	4	12	

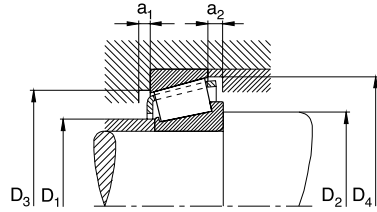

Load Rating · Factor							Permissible Speed		Standards		Weight
Dynamic C	e	Y	Static C ₀	Y ₀			Grease Lubrication	Oil Lubrication	Bearings	ISO 355 KS B 2027	≈ kg
N	kgf		N	kgf			min ⁻¹		KBC		
110000	11200	0.35	1.7	129000	13200	0.96	3800	5300	30309J	T2FB045	1.01
81500	8310	0.81	0.74	90000	9180	0.41	3400	4800	30309D		0.95
92000	9380	0.83	0.73	106000	10800	0.4	3400	4800	30309DJ	T7FB045	0.955
140000	14300	0.35	1.7	174000	17700	0.96	3800	5300	32309J	T2FD045	1.41
62000	6320	0.42	1.4	89500	9130	0.78	4300	6000	32010XJ	T3CC050	0.379
77000	7850	0.42	1.4	92500	9430	0.79	4000	5300	30210J	T3DB050	0.56
88000	8970	0.42	1.4	110000	11200	0.79	4000	5300	32210J	T3DC050	0.642
127000	12900	0.35	1.7	147000	15000	0.96	3400	4800	30310J	T2FB050	1.28
103000	10500	0.81	0.74	117000	11900	0.41	3200	4300	30310D		1.25
110000	11200	0.83	0.73	130000	13300	0.4	3200	4300	30310DJ	T7FB050	1.25
185000	18900	0.35	1.7	235000	24000	0.96	3600	4800	32310J	T2FD050	1.88
189000	19300	0.44	1.4	235000	24000	0.76	3600	4800	TR5011444		2.244
79500	8110	0.41	1.5	119000	12100	0.81	3800	5300	32011XJ	T3CC055	0.567
96000	9790	0.41	1.5	115000	11700	0.81	3600	5000	30211J	T3DB055	0.733
108000	11000	0.41	1.5	138000	14100	0.81	3600	5000	32211J	T3DC055	0.857
125000	12700	0.41	1.5	163000	16600	0.81	3600	5000	TR5510032		1.052
146000	14900	0.35	1.7	170000	17300	0.96	3200	4300	30311J	T2FB055	1.62
129000	13200	0.83	0.73	153000	15600	0.4	2800	4000	30311DJ	T7FB055	1.57
200000	20400	0.35	1.7	257000	26200	0.96	3200	4300	32311J	T2FD055	2.39
84500	8620	0.43	1.4	128000	13100	0.77	3600	5000	32012XJ	T4CC060	0.607
98500	10000	0.33	1.8	159000	16200	1	3600	5000	33012J	T2CE060	0.713
105000	10700	0.41	1.5	125000	12700	0.81	3400	4500	30212J	T3EB060	0.927
129000	13200	0.41	1.5	167000	17000	0.81	3400	4500	32212J	T3EC060	1.18
172000	17500	0.35	1.7	204000	20800	0.96	3000	4000	30312J	T2FB060	2.03
147000	15000	0.83	0.73	175000	17800	0.4	2600	3800	30312DJ	T7FB060	1.98
230000	23500	0.35	1.7	299000	30500	0.96	3000	4000	32312J	T2FD060	2.96
89500	9130	0.34	1.8	140000	14300	0.97	3400	4500	33013		0.732
123000	12500	0.41	1.5	154000	15700	0.81	3000	4000	30213J	T3EB065	1.18
133000	13600	0.4	1.5	168000	17100	0.82	3000	4000	32213J		1.58
154000	15700	0.41	1.5	198000	20200	0.81	3000	4000	32213J	T3EC065	1.55
251000	25600	0.35	1.7	219000	22300	0.94	2800	3800	TR6513051		3.036
203000	20700	0.35	1.7	238000	24300	0.96	2600	3600	30313J	T2GB065	2.5
170000	17300	0.83	0.73	203000	20700	0.4	2400	3400	30313DJ	T7GB065	2.42
259000	26400	0.35	1.7	335000	34200	0.96	2800	3800	32313J	T2GD065	3.6

KBC Tapered Roller Bearings

Single Row

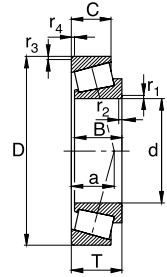

Shaft	Dimensions					r_1, r_2 min	r_3, r_4 min	Distance of Application Points $a \approx$	Abutment Dimensions						a_1 min	a_2 min
	d	D	B	C	T				D_1 max	D_2 min	D_3 min	D_3 max	D_4 min			
70	70	125	24	21	26.25	2	1.5	25.6	81	82	110	116	120	4	5	
	70	125	31	27	33.25	2	1.5	28.6	80	82	108	116	121	4	6	
	70	150	35	30	38	3	2.5	30.8	89	88	132	138	142	4	8	
	70	150	51	42	54	3	2.5	21	86	91	124	138	142	4	12	
75	75	130	31	27	33.25	2	1.5	29.8	84	87	113	121	127	4	6	
85	85	150	28	24	30.5	2.5	2	30.3	97	100	133	140	143	5	6.5	
	85	150	36	30	38.5	2.5	2	33.7	96	100	131	140	144	5	8.5	
90	90	140	32	24	32	2	1.5	29.8	99	102	124	131	136	6	8	
	90	150	36	30	38.5	2.5	2	34.5	103	113	130	132	145	4	8	
	90	160	40	34	42.5	2.5	2	36.1	102	114	135	145	153	4	6.5	
95	95	160	40	34	42.5	4	2.5	36.4	110	120	137	139	155	4	10	
	95	170	43	37	45.5	3	2.5	39.3	108	113	147	158	163	5	8.5	

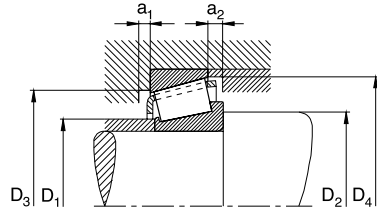

Load Rating · Factor								Permissible Speed		Standards		Weight
Dynamic C		e	Y	Static C ₀		Y ₀		Grease Lubrication	Oil Lubrication	Bearings	ISO 355 KS B 2027	≈ kg
N	kgf			N	kgf		min ⁻¹			KBC		
130000	13300	0.42	1.4	160000	16300	0.79	2800	4000		30214J	T3EB070	1.3
153000	15600	0.42	1.4	203000	20700	0.79	2800	4000		32214J	T3EC070	1.64
225000	22900	0.35	1.7	272000	27700	0.96	2400	3400		30314J	T2GB070	3.03
299000	30500	0.35	1.7	385000	39300	0.96	2600	3400		32314J	T2GD070	4.34
163000	16600	0.44	1.4	216000	22000	0.76	2800	3800		32215J	T4DC075	1.72
184000	18800	0.42	1.4	233000	23800	0.79	2400	3200		30217J	T3EB085	2.12
222000	22600	0.42	1.4	305000	31100	0.79	2400	3200		32217J	T3EC085	2.63
173000	17600	0.42	1.4	273000	27800	0.78	2400	3200		32018XJ	T3CC090	1.78
203000	20700	0.42	1.4	288000	29400	0.79	2400	3200		TR9015038		2.549
265000	27000	0.42	1.4	366000	37300	0.78	2400	3200		32218J	T3FC090	3.312
247000	25200	0.42	1.4	363000	37000	0.79	2400	3200		TR9516042		3.309
286000	29200	0.42	1.4	395000	40300	0.79	2200	2800		32219J	T3FC095	4.21



KBC Tapered Roller Bearings

Single Row · Inch Dimensions

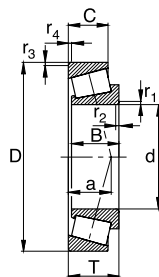

Shaft	Dimensions								Distance of Application Points a ≈	Abutment Dimensions					
	d	D	B	C	T	r ₁ r ₂ min	r ₃ r ₄ min	D ₁ max		D ₂ min	D ₃ min	D ₄ min	a ₁ min	a ₂ min	
	mm														
17.462	17.462	39.878	14.605	10.668	13.843	1.3	1.3	8.7	21.5	23	34	37	2	3	
19.05	19.05	45.237	16.637	12.065	15.494	1.3	1.3	9.5	23.5	25	39.5	41.5	2	4	
21.43	21.43	50.005	18.288	13.970	17.526	1.3	1.3	11.1	25.5	27.5	44	46	2	4	
21.986	21.986	45.237	16.637	12.065	15.494	1.3	1.3	10.3	26	27.5	39.5	42	2	4	
25.4	25.4	57.15	17.462	13.495	17.462	1.3	1.5	12.6	30.5	32.5	51	53	2	3.5	
26.988	26.988	50.292	14.732	10.668	14.224	3.5	1.3	10.9	31	37.5	44.5	47	2.5	4	
27	27	61.973	17	13.6	16.7	0.3	0.5	14.3	41	46	54	62	3.5	2	
27.487	27.487	57.175	19.355	15.875	19.845	2.5	1.5	14.2	33	37	53	54	2	6	
28.575	28.575	64.292	21.433	16.67	21.433	1.5	1.5	18.1	37	45	50	71	2.5	5	
	28.575	73.025	22.225	17.462	22.225	0.8	3.3	26	37	37.5	62	63	2	5	
29	29	50.292	14.732	10.668	14.224	3.5	1.3	10.8	33	39.5	44.5	48	3.5	3.5	
30.162	30.162	64.292	21.433	16.67	21.433	1.5	1.5	18.2	38	41	54	61	2.5	5.5	
	30.162	68.262	22.225	17.462	22.225	2.3	1.5	19.5	39.5	43.5	58	65	2	5	
31.75	31.75	59.131	16.764	11.811	15.875	3.6	1.3	12.6	38	42	51	56	4	4	
	31.75	62	19.05	14.288	18.161	4.8	1.3	13.1	36.5	42.5	55	58	4.5	3.5	
33.338	33.338	68.262	22.225	17.462	22.225	0.8	1.5	19.5	41	49	53	65	0.55	1.1	
34.925	34.925	65.088	18.288	13.97	18.034	4.8	1.3	14.5	40	46	58	61	3	4	
	34.925	65.088	18.288	17.018	21.082	4.8	1.5	17.6	40	46	58	61	2	5.5	
	34.925	68.262	20.638	15.875	20.638	3.5	2.3	15.2	40	46	59	63	3	4	
	34.925	69.012	19.583	15.875	19.845	3.5	1.3	15.7	40	46	60	63	3	4.5	
	34.925	72.233	25.4	19.842	25.4	2.3	2.3	20.9	42.5	48.5	60	69	3.5	4.5	
	34.925	73.025	24.608	19.05	23.812	1.5	0.8	15.8	40.5	43	65	68	3.5	6	
	34.925	76.2	28.575	23.02	29.37	3.5	3.3	23.9	44.5	53	62	73	2	5.5	
	34.925	76.2	28.575	23.812	29.37	1.5	3.3	21.8	43.5	46	64	72	2	6	
34.988	34.988	59.131	16.764	11.938	15.875	1.5	1.3	13.4	39	45.5	52	56	3	4.5	
	34.988	59.974	16.764	11.938	15.875	1.1	1.3	13.4	39	45.5	52	57	3	4.5	

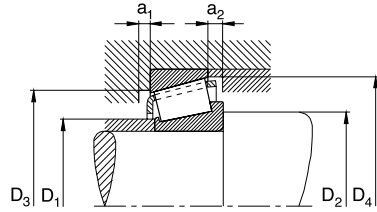

Load Rating · Factor							Permissible Speed		Standards	Weight
Dynamic C	e	Y	Static C ₀	Y ₀	Grease Lubrication	Oil Lubrication	Bearings		≈	
N	kgf		N	kgf	min ⁻¹		KBC		kg	
22500	2290	0.29	2.1	22500	2290	1.2	10000	13000	LM11749/LM11710	0.083
28500	2910	0.30	2	28900	2950	1.1	9000	12000	LM11949/LM11910	0.125
39000	3980	0.28	2.2	40500	4130	1.2	8000	11000	LM12649/LM12610	0.174
29600	3020	0.31	2	34000	3470	1.1	8000	11000	LM12749/LM12710	0.122
39500	4030	0.35	1.7	45500	4640	0.95	6700	9000	15578/15520	0.221
27300	2780	0.37	1.6	31500	3210	0.88	7100	10000	L44649/L44610	0.12
32300	3290	0.44	1.4	44000	4490	0.74	6200	8000	LM78349TF1/LM78310A	0.253
45600	4650	0.35	1.7	49300	5030	0.95	6300	8500	TR275720	0.245
52400	5340	0.55	1.1	65900	6720	0.6	5300	7100	M86647/M86610	0.287
55000	5610	0.45	1.3	65500	6680	0.73	5300	7100	02872/02820	0.481
27500	2800	0.37	1.6	34500	3520	0.89	7100	9500	L45449/L45410	0.115
51500	5250	0.55	1.1	66000	6730	0.6	5600	8000	M86649/M86610	0.339
55500	5660	0.55	1.1	70500	7190	0.6	5300	7500	M88043/M88010	0.409
34900	3560	0.41	1.5	41700	4250	0.8	6300	8500	LM67048/LM67010	0.189
43500	4440	0.35	1.7	50500	5150	0.94	6000	8000	15123/15245	0.246
55400	5650	0.55	1.1	70700	7210	0.6	5300	7500	M88048/M88010	0.325
46500	4740	0.38	1.6	57500	5860	0.88	5600	7500	LM48548/LM48510	0.269
46500	4740	0.38	1.6	57500	5860	0.88	5600	7500	LM48548/LM48511	0.28
48000	4890	0.36	1.7	57500	5860	0.91	5600	7500	14585/14525	0.296
46500	4740	0.38	1.6	57500	5860	0.86	5600	7500	14138A/14276	0.329
65500	6680	0.55	1.1	86000	8770	0.6	5000	7100	HM88649/HM88610	0.495
70000	7140	0.29	2.1	86000	8770	1.1	5300	7100	25877/25821	0.473
78500	8000	0.55	1.1	106000	10800	0.6	4800	6700	HM89446/HM89410	0.657
81500	8310	0.4	1.5	98000	9990	0.82	5000	6700	31594/31520	0.639
34000	3470	0.42	1.4	46000	4690	0.79	6000	8000	L68149/L68110	0.173
34000	3470	0.42	1.4	46000	4690	0.79	6000	8000	L68149/L68111	0.211

Bearings of different designs can be custom-made on request.

KBC Tapered Roller Bearings

Single Row · Inch Dimensions

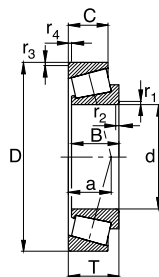

Shaft	Dimensions								Distance of Application Points a ≈	Abutment Dimensions					
	d	D	B	C	T	r ₁ r ₂ min	r ₃ r ₄ min	D ₁ max		D ₂ min	D ₃ min	D ₄ min	a ₁ min	a ₂ min	
	mm														
36.512	36.512	76.2	28.575	23.02	29.37	3.5	3.3	23.9	44.5	54	62	73	2	5	
	36.512	79.375	28.829	22.664	29.37	3.5	3.3	23.6	44	55	66	75	2.5	6	
38	38	63	17	13.5	17	4.75	1.3	14.6	42.5	49	56	60	2.5	3.5	
38.1	38.1	65.088	16.75	12.5	16.5	0.8	1.3	13	44	48	60	62	3	3	
	38.1	65.088	21.139	13.97	18.034	4.75	1.3	13.7	46	48	57	62	3.5	4	
	38.1	69.012	19.05	15.083	19.05	3.5	0.8	16.1	43	49.5	62	65	2	4.5	
	38.1	69.012	19.05	15.083	19.05	2	2.3	16.1	43	46.5	61	65	2	4	
	38.1	76.2	25.654	19.05	23.812	4.3	3.3	16.2	43.5	52	66	70	4	4	
40.988	40.988	67.975	18	13.5	17.5	1.5	1.6	13.9	45	52	61	65	3.5	4	
41.275	41.275	73.025	17.462	12.7	16.667	3.5	1.5	13.9	46	53	66	69	3.5	4	
	41.275	73.431	19.812	14.732	19.558	3.5	0.8	16.3	46.5	53	67	70	3	5	
	41.275	76.2	23.02	20.638	25.4	3.5	2.3	20.6	47	54	66	72	2	4	
42.862	42.862	76.992	17.145	11.908	17.462	1.5	1.5	17.5	48.5	51	68	73	3.5	6.5	
42.875	42.875	82.931	25.4	22.225	26.988	3.5	2.3	20.8	49	55	72	77	2	6	
45.23	45.23	79.985	20.638	15.08	19.842	2.03	1.3	15.9	52	57	68	74	4	5	
	45.23	80	19	16	20	1.5	1.5	18	53	58	71	77	2	6	
45.242	45.242	73.431	19.812	15.748	19.558	3.5	0.8	14.9	50	56	68	70	2.5	3.5	
45.987	45.987	74.976	18	14	18	3.6	1.6	15.9	52	57	66	72	3	4.5	
50	50	82	21.5	17	21.5	3	0.5	16.1	55	60	76	78	4	5	
	50	93.264	30.302	23.812	30.162	3.6	3.2	22	53	59	82	88	2	6.5	
52.388	52.388	85	20	15	20	1.5	1.5	17.7	59	64	79	82	3	5.5	
	52.388	92.075	25.4	19.845	24.608	3.5	0.8	20.4	58	65	83	87	2	4	
57.15	57.15	87.312	18.258	14.288	18.258	1.5	1.5	17.3	62	65	79	83	4	3.5	
	57.15	112.712	30.048	23.812	30.162	3.5	3.3	26	66	72	99	106	4.5	14	
60	60	95	24	19	24	5	2.5	21	66	75	85	91	4	4	
60.325	60.325	100	25.4	19.845	25.4	3.5	3.3	23.1	67	73	89	96	4.5	12.5	
	60.325	101.6	25.4	19.845	25.4	3.5	3.3	23.1	67	73	90	97	2	5.5	

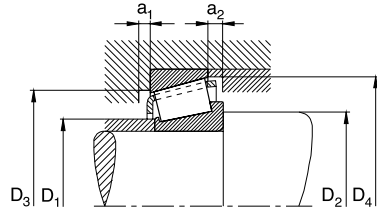

Load Rating · Factor							Permissible Speed		Standards	Weight
Dynamic C	e	Y	Static C ₀		Y ₀	Grease Lubrication	Oil Lubrication	Bearings	≈	
N	kgf		N	kgf		min ⁻¹		KBC	kg	
78500	8000	0.55	1.1	106000	10800	0.6	4800	6700	HM89449/HM89410	0.637
87000	8870	0.55	1.1	119000	12100	0.6	4800	6700	HM89249/HM89210	1.02
38000	3870	0.42	1.4	51500	5250	0.79	5600	7500	JL69349/JL69310	0.203
41500	4230	0.33	1.8	52000	5300	1	5300	7100	TR386516	0.216
42500	4330	0.33	1.8	55600	5670	0.99	5300	7500	38KW01Cg5	0.241
48000	4890	0.4	1.5	61500	6270	0.82	5300	7100	13685/13620	0.296
48000	4890	0.4	1.5	61500	6270	0.82	5300	7100	13687/13621	0.297
74000	7550	0.30	2	86000	8770	1.1	5300	7100	2776/2720	0.49
43000	4380	0.35	1.7	57500	5860	0.95	5300	7100	LM300849/LM300811	0.242
45500	4640	0.35	1.7	55000	5610	0.94	4800	6700	18590/18520	0.285
55500	5660	0.4	1.5	69000	7040	0.83	4800	6700	LM501349/LM501310	0.334
67000	6830	0.39	1.5	84000	8570	0.84	4800	6700	24780/24721	0.468
45000	4590	0.51	1.2	56100	5720	0.65	4600	6300	12168/12303	0.31
75500	7700	0.33	1.8	100000	10200	0.99	4500	6000	25577/25523	0.629
61000	6220	0.37	1.6	79500	8110	0.9	4500	6000	17887/17831	0.41
53000	5400	0.43	1.4	39000	3980	0.77	4300	6000	TR458020	1.17
55000	5610	0.31	2	77000	7850	1.1	4800	6300	LM102949/LM102910	0.315
51800	5280	0.4	1.5	71300	7270	0.82	4500	6000	LM503349/LM503310	0.305
70500	7190	0.31	2	95500	9740	1.1	4300	5600	JLM104948/JLM104910	0.435
104000	10600	0.34	1.8	138000	14100	0.97	4100	5200	3780F/1/3720	0.576
61000	6220	0.4	1.5	78000	7950	0.82	3800	5300	TR528520	0.392
82000	8360	0.38	1.6	112000	11400	0.87	4000	5300	28584/28521	0.682
58300	5940	0.39	1.5	94000	9580	0.85	4000	5300	L507949/L507910	0.38
118000	12000	0.4	1.5	173000	17600	0.82	3200	4300	3979/3920	1.376
82500	8410	0.4	1.5	123000	12500	0.82	3600	5000	JLM508748/JLM508710	0.63
91000	9280	0.42	1.4	135000	13800	0.87	3400	4800	28985/28921	0.770
85000	8670	0.42	1.4	135000	13800	0.87	3400	4800	S28985/S28920	0.776

Bearings of different designs can be custom-made on request.

KBC Tapered Roller Bearings

Single Row · Inch Dimensions

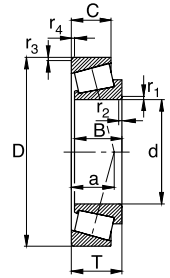

Shaft	Dimensions							Distance of Application Points a ≈	Abutment Dimensions					
	d	D	B	C	T	r ₁ r ₂ min	r ₃ r ₄ min		D ₁ max	D ₂ min	D ₃ min	D ₄ min	a ₁ min	a ₂ min
	mm													
63.5	63.5	112.712	30.048	23.812	30.162	3.5	3.3	26	71	77	99	106	4.5	14
65	65	105	23	18.5	24	3	1	23.7	71	77	96	101	3.5	7
66.675	66.675	110	21.996	18.824	22	3.5	1.3	21.4	73	79	101	104	6.5	6.5
	66.675	112.712	30.048	23.812	30.162	3.5	3.3	26	74	80	99	106	4	6
	66.675	112.712	30.048	23.812	30.162	5.5	3.3	26	74	84	99	106	4.5	14
68.262	68.262	110	21.996	18.824	22	2.3	1.3	21.4	74	78	101	104	5	3
	68.262	136.525	41.275	31.75	41.275	3.5	3.3	30.7	82	86	121	129	9.5	18
69.85	69.85	146.05	39.688	25.4	41.275	3.5	3.3	45	82	95	124	138	4.5	13
82.55	82.55	133.35	33.338	26.195	33.338	3.5	3.3	29.4	90	97	119	128	6	7
	82.55	139.992	36.098	28.575	36.512	3.5	3.3	31.2	91	98	125	133	10.5	16
85.725	85.725	152.4	36.322	30.162	39.688	3.5	3.3	37.1	98	104	135	144	2	6.5
88.9	88.9	152.4	36.322	30.162	39.688	6.4	3.3	37.1	98	104	135	144	4.5	18
92.075	92.075	152.4	38.5	30.162	39.688	6.4	3.3	35.3	101	113	135	144	4	9.5

KBC Tapered Roller Bearings

Double Row



KBC Tapered Roller Bearings

Double Row · Basic Designs · Tolerances · Bearing Clearances · Speed Suitability · Heat Treatment · Cages · Equivalent Loads · Prefixes

Basic Designs

A double row tapered roller bearing is assembled with two inner ring parts of single row tapered roller bearing in back-to-back arrangement on the unitized outer ring. Since the inner clearance is set for the bearing itself by design, its operation as well as its mounting can be carried out uniformly without much adjustment, and this is why it is used for automotive hubs and others to maintain optimum performance considering their sizes and functions.

These bearings can be divided into two groups, one with seals and the other without seals.

Tolerances

Tapered roller bearings of the basic designs in metric dimensions have a normal tolerance, but the bearing precisions can be increased on request.

Bearing Clearances

Because axial clearances of double row tapered roller bearings vary depending on tight-fits of mating parts, shaft or housing, and temperature variation during operation, their values are determined precisely in advance to provide optimum operation.

Axial clearances for KBC double row tapered roller bearings are set accordingly in such a way that will provide optimum performances under such mounting and operating conditions, and the clearances can be adjusted on request.

Speed Suitability

The permissible speeds for both grease and oil lubrication are shown on the Dimension Tables. In case of oil lubrication, the permissible speeds shown on the Dimension Tables are the values assuming oil sump lubrication. Depending on various lubricating methods, they can be operated at a higher speed.

Heat Treatment

KBC double row separable tapered roller bearings without seals are heat-treated in such a way that they can be used at operating temper-

atures of up to 120°C or above over extended periods. However, for those with seals, the operating temperatures are restricted by the temperature limit of used seal materials, and, for example, in case of contact seals made of NBR, it can be used at operating temperatures of up to 100 °C. For the bearings required to be used at higher temperatures, please contact KBC.

Cages

KBC double row tapered roller bearings have glass-fiber reinforced polyamide 66 cages as a basic design, and some cages are made from pressed steel.

Equivalent Dynamic Load

$$P = F_r + Y_3 \cdot F_a \quad : \text{for } \frac{F_a}{F_r} \leq e$$

$$P = 0.67 \cdot F_r + Y_2 \cdot F_a \quad : \text{for } \frac{F_a}{F_r} > e$$

The values of Y_2 and Y_3 are listed in the Dimension Tables.

Equivalent Static Load

$$P_0 = F_r + Y_0 \cdot F_a$$

The values of Y_0 are listed in the Dimension Tables.

Prefixes

DT Double row tapered roller bearing



KBC Needle Roller Bearings



KBC Needle Roller Bearings

Basic Designs · Cages · Surrounding Structure Designs · Equivalent Loads · Prefixes · Suffixes

The primary feature of needle roller bearings is their high load carrying capacity in spite of a low section height, thus meeting the requirements of lightweight constructions as regards high capacity in a restricted mounting space.

Needle roller bearings can be largely divided into a few groups depending on their shapes; cage and roller types, shell types, and solid types.

Basic Designs

KBC needle roller bearings of cage and roller type are either single row or double row, and the rollers are manufactured in accordance with ISO 6193.

Also, for the bearings impossible to assemble because of the abutment shapes, the bearings with cage (Suffix SP) attached with connecting parts are available.

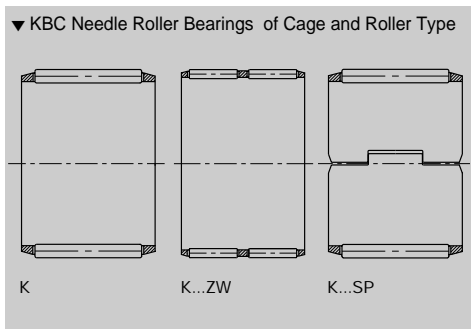

Cages

Cages of KBC needle roller bearings are generally made from glass-fiber reinforced polyamide 66.

These cages can be used at operating temperatures of up to 120°C over extended periods. If the bearings are lubricated with oil, any additives contained in the oil may reduce the cage service life. Also, aged oil may reduce the cage life at higher temperatures; therefore, the oil change intervals have to be strictly observed.

Surrounding Structure Design

Because KBC needle roller bearings of cage and roller type are mounted and rotated between shaft and housing, the rigidity of both shaft and housing should be determined in the same range as that of needle roller bearings.

Following Table shows the recommendations for machining bearing seats.

▼ Recommended Machining Values for Shaft and Housing		
Kinds	Shaft	Housing
Dimension Tolerances	j5(js5)	G6
Circularity ¹⁾	IT3	IT3
Cylindricity ¹⁾	IT3	IT3
Roughness Class ²⁾	N5	N6
Hardness	HRC58-64 Hardened layer is required up to proper	HRC58-64 Hardened layer is required up to proper

1) Refer to Appendix 12 for the IT tolerance values.
2) Refer to Table 11-2 on Page 100 for roughness class.

Equivalent Dynamic Load

Needle roller bearings can accommodate only radial loads.

$$P = F_r$$

Equivalent Static Load

Needle roller bearings can accommodate only radial loads.

$$P_0 = F_r$$

Prefixes

K Needle roller bearings of cage and roller type

Suffixes

- h** Width dimensions differ from the standards.
- PC** Glass-fiber reinforced polyamide 66 cage
- SP** Cages with connecting parts
- ZW** Double row



KBC Unit Bearings



KBC Unit Bearings

Standards · Basic Designs · Plummer Block Housing · Flanged Housing

Unit bearings are preferably used for applications calling for simplicity of design and assembly.

KBC programme includes unit bearings and the suitable plummer block housings and flanged housings.

Unit bearings are used almost exclusively as locating bearings. Therefore, they are particularly suitable for supporting short shafts and for applications where only minor thermal expansions are likely to occur. Minor expansions of the shaft are compensated for by the axial clearance of the bearings.

Standards

Unit ball bearing	KS B 2049
Unit ball bearing housing	KS B 2050

Basic Designs

Unit bearings of UC and UB Series can be fitted into different housings.

They are fastened on the shaft by means of two threaded pins (See tightening torque and wrench openings indicated in the Table below.). The flinger rings protect UC Series bearings from coarse contaminants.

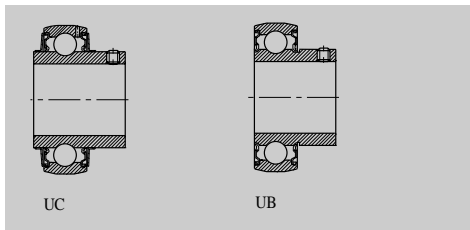

Grey-cast Iron Plummer Block Housing

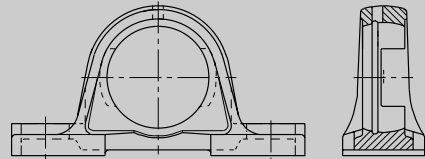

P Housing

Pressed Steel Plummer Block Housing

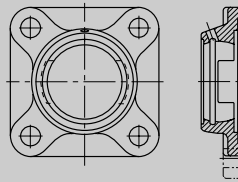

F Housing

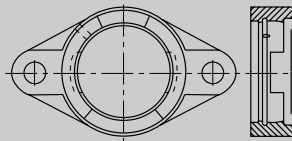

FL Housing

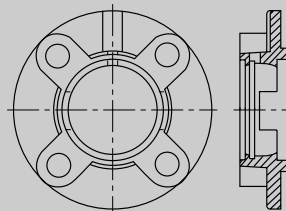

FC Housing

▼ Tightening Torque and Wrench Openings for the Threaded Pins of UC and UB Series Bearings

Bearing Series	Bore Reference Number									
UC, UB Series	04	05	06	07	08	09	10	11	12	13
Tightening Torque (Nm)	6	6	6	12	12	12	23	23	23	23
Wrench Opening (mm)	3	3	3	4	4	4	5	5	5	5

KBC Unit Bearings

Lubrication · Alignment · Tolerances · Bearing Clearances · Operating Temperature · Speed Suitability · Equivalent Loads

Lubrication

KBC unit bearings require no maintenance, and the standard grease filling will generally last for the whole bearing life. It is possible to relubricate through lubrication nipples.

The bearings have one lubricating hole in the outer ring.

Alignment

KBC bearings can compensate for static misalignments of up to 5° out of the center position. The angular misalignment of bearings which are relubricated must not exceed 2° as otherwise the lubricating hole in the outer ring will be covered and no longer accessible.

Tolerances

Basically, KBC unit bearings are machined to the normal tolerance class of radial bearings as shown on Page 66. However, since the bearing bore is loosely fitted to the shaft, and fastened by means of set screws, the tolerance range becomes comparatively bigger. The following Table shows the tolerances of bore diameters.

Bearing Clearance

KBC unit bearings have the radial clearances of deep groove ball bearings as shown on Page 92. Unit bearings with a higher precision can be supplied on request.

Operating Temperature

KBC unit bearings are filled with a specially tested quality grease. The maximum operating temperature is 100°C and the lower temperature limit is -30°C.

Speed Suitability

The speeds attainable with KBC unit bearings are determined primarily by the bearing seat on the shaft. The speeds reached with relatively rough shafts and loose fits are low. Higher speeds are reached with tighter fits and more accurately machined shafts. The following Table lists the attainable speeds for various shaft tolerances.

▼ Tolerances of Bore Diameter					
		Unit : mm			
UC, UB Series	Over	10	18	30	50
	To	18	30	50	80
		Tolerances : μm			
Deviation of the mean bore diameter	Δ_{dmp}	+18	+21	+25	+30
		0	0	0	0

▼ Attainable Speeds							
Bore Reference Number	Shaft	Shaft Tolerance					
		m7,k7	j7	h7	h8	h9	h10
	mm	Speed : min ⁻¹					
04	20	10000	8000	5000	3600	1200	800
05	25	9000	7200	4500	3100	1100	720
06	30	7500	6000	3800	2600	900	600
07	35	6300	5000	3200	2200	750	500
08	40	5600	4500	2800	1900	670	450
09	45	5300	4300	2600	1800	630	430
10	50	4800	3800	2400	1700	580	380
11	55	4300	3400	2200	1500	520	340
12	60	4000	3200	2000	1400	480	320
13	65	3700	3000	1800	1300	440	290

KBC Unit Bearings

Equivalent Loads

Equivalent Dynamic Load

$$P = X \cdot F_r + Y \cdot F_a$$

The contact angles of deep groove ball bearings increase as their axial loads increase. Therefore, factors, X and Y, depend on F_a/C_o , as shown below.

▼ Radial and Axial Factors of Unit Bearings

F_a/C_o	e	$F_a/F_r \leq e$		$F_a/F_r > e$	
		X	Y	X	Y
0.014	0.19	1	0	0.56	2.30
0.028	0.22	1	0	0.56	1.99
0.056	0.26	1	0	0.56	1.71
0.084	0.28	1	0	0.56	1.55
0.11	0.30	1	0	0.56	1.45
0.17	0.34	1	0	0.56	1.31
0.28	0.38	1	0	0.56	1.15
0.42	0.42	1	0	0.56	1.04
0.56	0.44	1	0	0.56	1.00

Equivalent Static Load

$$P_0 = F_r \quad : \text{ for } \frac{F_a}{F_r} \leq 0.8$$

$$P_0 = 0.6 \cdot F_r + 0.5 \cdot F_a \quad : \text{ for } \frac{F_a}{F_r} > 0.8$$



KBC Unit Bearings

UC2, UB2 Series

P2, F2 Grey-cast Plummer Block Housing and Flanged Housing

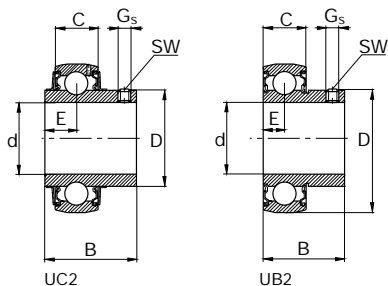

Shaft	Dimensions															
	Bearings d	D	C	B	E	G _s KS B 1028	SW	P Housing a	b	c	h	h ₁	m	F Housing a ₁	c ₁	
	mm															
20	20	47	16	31	12.7	M6x0.75	3	127	38	15	33.3	65	95	86	12	
	20	47	14	25	7	M6x0.75	3	127	38	15	33.3	65	95	86	12	
25	25	52	17	34	14.3	M6x0.75	3	140	38	16	36.5	71	105	95	14	
	25	52	15	27	7.5	M6x0.75	3	140	38	16	36.5	71	105	95	14	
25.4	25.4	52	17	34	14.3	M6x0.75	3	140	38	16	36.5	71	105	95	14	
30	30	62	19	38.1	15.9	M6x0.75	3	165	48	18	42.9	84	121	108	14	
35	35	72	20	42.9	17.5	M8x1	4	167	48	19	47.6	94	127	117	16	
40	40	80	21	49.2	19	M8x1	4	184	54	19	49.2	100	137	130	16	
45	45	85	22	49.2	19	M8x1	4	190	54	20	54	108	146	137	18	
50	50	90	23	51.6	19	M10x1.25	5	206	60	22	57.2	114	159	143	18	
55	55	100	24	55.6	22.2	M10x1.25	5	219	60	22	63.5	126	171	162	20	
60	60	110	27	65.1	25.4	M10x1.25	5	241	70	25	69.8	138	184	175	20	
65	65	120	28	65.1	25.4	M10x1.25	5	265	70	27	76.2	150	203	187	20	

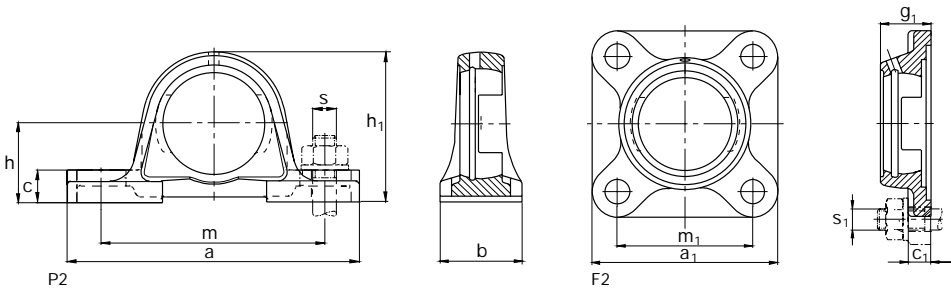

Fastening Bolt		Load Rating				Code			Weight ≈				
F Housing g ₁ mm	m ₁	PHousing S	FHousing S ₁	Dynamic C	Static C ₀	Bearing KBC	P Housing KBC	F Housing KBC	Bearing kg	UCP Unit	UCF Unit		
				N	kgf	N	kgf						
25.5	64	M10	M10	12800	1310	6650	678	UC204	P204	F204	0.16	0.68	0.62
25.5	64	M10	M10	12800	1310	6650	678	UB204	P204	F204	0.15	0.67	0.61
27	70	M10	M10	14000	1430	6650	678	UC205	P205	F205	0.19	0.82	0.83
27	70	M10	M10	14000	1430	7900	806	UB205	P205	F205	0.17	0.8	0.81
27	70	M10	M10	14000	1430	7900	806	UC205-16	P205	F205	0.18	0.81	0.82
31	83	M14	M10	19400	1980	11300	1150	UC206	P206	F206	0.31	1.36	1.14
34	92	M14	M12	25700	2620	15400	1570	UC207	P207	F207	0.48	1.73	1.47
36	102	M14	M14	29100	2970	17800	1820	UC208	P208	F208	0.62	2.1	2
38	105	M14	M14	32500	3310	20400	2080	UC209	P209	F209	0.67	2.3	2.4
40	111	M16	M14	35000	3570	23200	2370	UC210	P210	F210	0.78	2.7	2.6
43	130	M16	M16	43500	4440	29200	2980	UC211	P211	F211	1.03	3.4	3.6
48	143	M16	M16	52500	5350	36000	3670	UC212	P212	F212	1.45	4.8	4.8
50	149	M20	M16	57000	5810	38500	3930	UC213	P213	F213	1.71	5.7	5.8

Bearings and housings of other designs can be supplied on request.
Machining dimensions may change without notice.

KBC Thrust Ball Bearings

Single Direction



KBC Thrust Ball Bearings

Single Direction · Basic Designs · Tolerances · Cages · Axial Loads · Abutment Dimensions · Prefixes · Suffixes Basic Designs

Basic Designs

Separable thrust ball bearing consists of fixed ring, revolving ring, rolling element, and cage. These bearings can transmit only axial loads, and they are mainly used for low and medium speeds. King-pin thrust ball bearings are non-separable bearings, and they are manufactured to have no cages so as to accommodate as many balls as possible, and their steel design holds the fixed ring and revolving ring together permanently, and some of them are attached, depending on operating conditions, with sealing device, such as rubber seal or O-ring.

Tolerances

Thrust ball bearings as basic designs are machined to normal tolerances. Bearings with higher precisions(Suffixes P6 or P5) can be supplied on request.

Precision: Tolerances of Thrust Ball Bearings on Page 80.

Cages

Thrust ball bearings of basic designs are equipped with the pressed steel cages(No assigned suffix). Some thrust ball bearings(Suffix V) are manufactured to have no cages so as to accommodate as many balls as possible.

Minimum Axial Load, High Speeds

At high speeds, bearing kinematics is affected by the inertia forces of the balls, if the axial load does not reach a certain minimum value.

If the external axial load is too low, the bearings

must be preloaded, e.g. by means of springs.

Equivalent Dynamic Load

Thrust ball bearings can accommodate only axial loads.

$$P = F_a$$

Equivalent Static Load

Thrust ball bearings can accommodate only axial loads.

$$P_0 = F_a$$

Abutment Dimensions

The bearing washers should closely fit the shaft or housing shoulder, they must not be allowed to foul the shoulder fillet radius. Consequently, the maximum fillet radius r_g of the mating part must be smaller than the minimum corner r_{min} of the thrust ball bearing.

The shoulder of the mating parts must be so high that even with maximum bearing corner, there is an adequate abutment surface. The maximum fillet radius R , the minimum diameters of abutment shoulders of shaft, D_s , and the maximum diameters of abutment shoulders of housing, d_h , are shown on the Dimension Tables.

Prefixes

S Bearings with steel cover

Suffixes

TAG King-pin thrust ball bearing
V Bearing with no cage

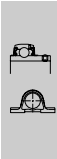

Thrust Ball Bearing, Single Direction

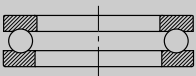

511

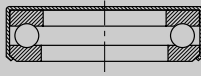

King-pin thrust ball bearing

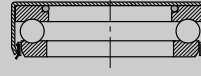

Sealed king-pin thrust ball bearing

KBC Water Pump Bearings



KBC Water Pump Bearings

Standards

Water pump bearings are originally known to be the solid shaft bearing, but, because they are mainly used for automotive water pumps, they are usually called as water pump bearings as a matter of convenience. In general, they have a structure unitized with double row bearing, and also with unitized bearing inner ring and shaft. Therefore their structure allows them to be comparatively smaller and lighter than others.

When a water pump bearing is mounted, impeller for supplying cooling water is attached on one end of the shaft, and a driving pulley on the other end.

Standards

In case of water pump bearings, because they are designed and machined to meet the specifications and conditions required for automotive water pumps, all design specifications are basically set to comply with customers' requirements.

Basic Designs

Water pump bearings are non-separable sealed bearings, and they can be divided into two types depending on the kinds their rolling elements, ball-ball type and ball roller type.

Because the load capacity of ball-roller type water pump bearings is a lot higher than that of ball-ball type, they are suitable to be used when they have to support fan couplings, or when they have to transmit high belt loads, or off-set loads. KBC water pump bearings have the designs with following

features, so as to provide the excellent durability.

- Surface hardened shaft for better resistance against bending fatigue.
- Long roller with high load support capacity.
- Plastic cage with excellent lubrication and abrasive-resistance.
- High-quality grease exclusively for water pump bearings with long service life and high water-resistance.
- Seal with tighter sealing quality and protection against grease leakage.

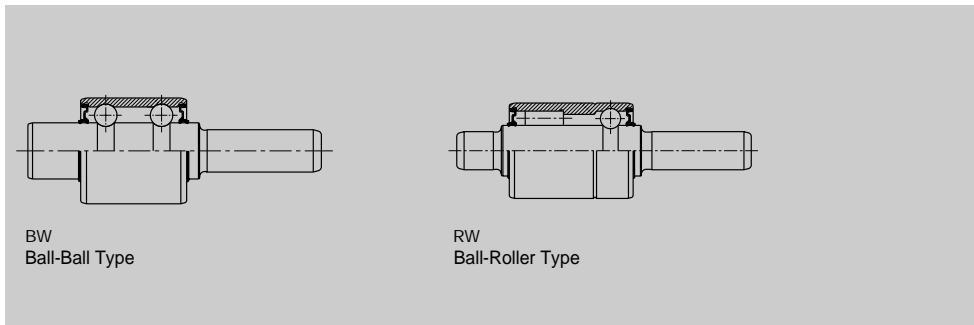

BW
Ball-Ball Type

RW
Ball-Roller Type

KBC Water Pump Bearings

Tolerances · Bearing Clearances · Cages · Seals · Tight-Fits

Tolerances

In case of water pump bearings, because they are designed and machined to meet the specifications and conditions required for automotive water pumps, all tolerances are basically set to comply with customers' requirements.

One example of the tolerances for KBC water pump bearings is shown below for reference only, and they can be changed on customers' requirements and different precision classes. Therefore, it is necessary to contact and consult KBC before placing an order.

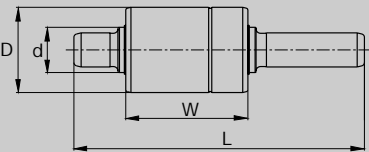

▼ Tolerances of KBC Water Pump Bearing

Kinds	Unit : mm			
	D	W	d	L
Tolerances	0 -0.013	0 -0.178	0 -0.013	+0.25 -0.25

Bearing Clearances

Radial clearances of KBC standard water pump bearings are shown below.

The bearings with different clearances can be supplied on request.

▼ Radial Clearances of KBC Water Pump Bearing

Outer Diameter	Unit : mm			
	Ball		Roller	
	Min	Max	Min	Max
30	0.015	0.03	0.015	0.03
35	0.012	0.027	0.01	0.025
38.1	0.01	0.03	0.01	0.03
42	0.012	0.022	0.015	0.035

Cages

Cages of KBC water pump bearings are generally made from glass-fiber reinforced polyamide 66.

These cages can be used at operating temperatures of up to 120°C over extended periods. When required to use KBC standard water pump bearings under higher operating temperatures, please contact KBC in advance.

Seals

Seals of water pump bearings have the structures as shown below, and they are classified depending on the number and shape of seal lips, 2-LIP or 4-LIP.

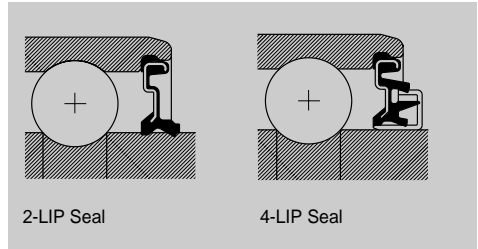

Tight-Fits of Housing

Bearing housing has to be properly tight-fitted to maintain bearing's own basic properties. Deviation or quality let-down of housing bore diameter, circularity and inclination, may cause early breakdown of the bearing.

Recommended housing tight-fit conditions are listed below.

KBC Water Pump Bearings

Codes

▼ Recommended Housing Tight-fit Conditions for KBC Water Pump Bearings

Outer Diameter of Outer Ring [mm]	Housing Bore	
	Cast Iron Housing	Aluminum Alloy Housing
30 35	R6	U6
38.1 42	R7	U7

The roundness of housing bore should be within a half of the diameter tolerance.

The taper of tapered face should not exceed a taper ratio of 0.0005.

When a housing made of different materials is to be applied, please contact KBC in advance.

Codes

Codes for water pump bearings are assigned as follows.

▼ Codes for Water Pump Bearings

Example: RCHL - RW 30 62 01 - LB6 F4L G43

Material Code

RCHL Heat-treated carburized steel inner ring for long life

Type Code

RW Ball-Roller Type
BW Ball-Ball Type

Outer Diameter of Outer Ring Code

30	30mm
35	35mm
38	38.1mm
42	42mm

* Decimals are rounded down.

Auxiliary Code

Seal	Flinger	Grease
L	F4L	G1
LB6		G2
Q		.
		G101

Development Consequence Code

Outer Diameter of Inner Ring Code

62	0.6267" = 15.918mm
70	0.7087" = 18mm
74	0.7465" = 18.961mm
86	0.8661" = 22mm

* After converting inner ring outer diameter to inch dimension, it is rounded down to two decimals

Load Rating								Standards KBC	Weight ≈ Bearings kg
Ball Dynamic C		Static C ₀		Roller Dynamic C		Static C ₀			
N	kgf	N	kgf	N	kgf	N	kgf		
6600	673	2700	276	11900	1210	10200	1040	RW306212	0.152
6600 ¹⁾	673 ¹⁾	2700 ¹⁾	276 ¹⁾					BW306201	0.159
6600	673	2700	276	11900	1210	10200	1040	RW306213	0.174
6600	673	2700	276	18200	1860	17500	1790	RW306211	0.2
6600	673	2700	276	18200	1860	17500	1790	RW306206	0.2
6600	673	2700	276	18200	1860	17500	1790	RW306201	0.204
6600	673	2700	276	18200	1860	17500	1790	RW306203	0.225
6600	673	2700	276	18200	1860	17500	1790	RW306202	0.218
8100	827	3400	347	22000	2250	20600	2100	RW357005	0.265
8100	827	3400	347	22000	2250	20600	2100	RW357002	0.273
8100	827	3400	347	22000	2250	20600	2100	RW357004	0.265
8100	827	3400	347	22000	2250	20600	2100	RW357001	0.28
8100	827	3400	347	22000	2250	20600	2100	RW357003	0.29
9750	995	4200	429	24500	2500	22700	2320	RW387401A	0.4
11600	1180	5100	520	26000	2650	25100	2560	RW428601	0.458
11600	1180	5100	520	26000	2650	25100	2560	RW428602	0.59

Bearings of different designs can be custom-made on request.

KBC One Way Clutch Bearings



KBC One Way Clutch Bearings

Basic Designs · Tolerances · Cages and Springs · Equivalent Loads

KBC one way clutch bearings have the structure unitizing both deep groove ball bearing, which can transmit both radial and axial loads, and the one way clutch roller bearing, which can control the single direction revolution, and they are mainly used for the driving gears of automatic washing machines.

Basic Designs

There are two types of one way clutch bearings, one with both unitized inner and outer rings, and the other with outer ring whose ball and clutch sections can be separated. In case of separable outer ring type, the outer diameter of deep groove ball bearing is set smaller than that of clutch in consideration of tight-fit conditions with housing, and its inner clearance is also set to be large accordingly.

A roller in the clutch always sticks closely with inner ring track surface and cam-shaped outer ring track surface by means of the spring on the pocket wall. This restricts inner ring to revolve in one direction, but allows sliding revolution with roller in the other direction. These bearings are supplied in sealed type, and both contact type seals and non-contact type seals are available. Also, for easy identification of the revolving direction, the different colors are painted on both ball and clutch sections in addition to outer ring groove at the manufacturer's plant.

Tolerances

One way clutch bearings are machined to the normal tolerances of radial bearings, and the outer diameter of ball bearing is machined to the low limit for clutch outer diameter in minus values.

Cages and Springs

Cages of both ball and clutch sections of these bearings are generally made from glass-fiber reinforced polyamide 66.

These cages can be used at operating temperatures of up to 120°C over extended periods.

S-shaped springs are made from stainless spring steel(STS304-CSP), and they play an important role of sticking roller between outer ring cam and inner ring in the clutch. Therefore springs are made to sufficiently withstand the repeated loads accordingly.

Equivalent Dynamic Loads

$$P = X \cdot F_r + Y \cdot F_a$$

For the factors, X and Y, please refer to the Table, Radial and Thrust Factors for Deep Groove Ball Bearings on Page 134.

Equivalent Static Load

$$P_0 = F_r \quad : \text{ for } \frac{F_a}{F_r} \leq 0.8$$

$$P_0 = 0.6 \cdot F_r + 0.5 \cdot F_a \quad : \text{ for } \frac{F_a}{F_r} > 0.8$$

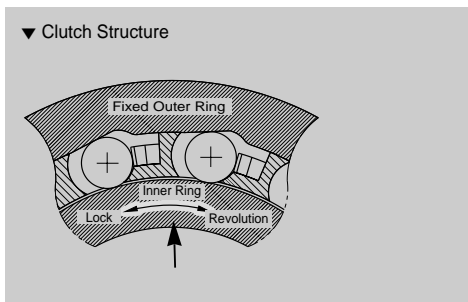

KBC One Way Clutch Bearings

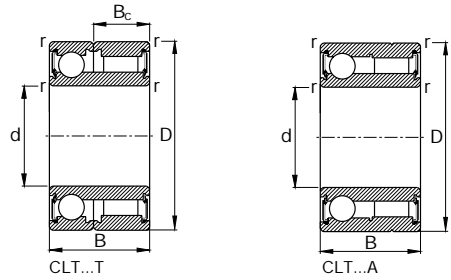

Shaft	Dimensions					Abutment Dimensions		
	d mm	D	B	B _c	r min	D _s min	d _h max	R max
25	25	47	25	14	0.6	28	43.5	0.6
	25	47	25		0.6	28	43.5	0.6

In case of sealed bearings, both contact seal type and non-contact shield type are available.
 1) In case of CLT05T type, two types depending on locking directions are available.

KBC Ceramic Bearings



KBC Ceramic Bearings

Material Characteristics · Basic Designs · Tolerances · Prefixes · Suffixes

Because KBC ceramic bearings are made of fine ceramic, which has excellent properties of corrosion-proof, heat-resistance, magnetism-proof, and insulation, they can be used where steel bearing can't be used for various reasons, providing excellent performances. Also, they have excellent lubrication and vacuum-resistance properties, which make them an excellent choice for clean room equipments and high-vacuum room equipments. And they are not affected by electro-magnetism at all.

Characteristics of Ceramic Materials

Ceramic for KBC ceramic bearings is made from high purity nitro-silicon by means of high temperature static water pressure pressing. This material has low density and high tensile strength, and their excellent performances have been proven over and over again.

Comparisons with steel bearings are shown below.

Basic Designs

KBC ceramic bearings can be largely divided into 3 types, depending on their uses.

In case of bearings for high temperature use and corrosion-proof property, ceramic inner/outer rings and rolling elements are used, but with steel cage(STS304) for high temperature use, and with fluorine resin(PTFE) cage for corrosion proof

property. The bearings for high temperature use can be used at operating temperatures of up to 500°C over extended periods.

By utilizing its light weight, ceramic is also used to make rolling elements for high speed bearings, which reduce centrifugal forces of revolving bearings drastically. And cages are usually made from glass-fiber reinforced polyamide 66 or from penol resin base with fabric layers.

KBC also supplies insulation bearings made of ceramic on outer ring surface and width surface of bearings.

Ceramic materials and cages of these ceramic bearings can be altered to suit their operating conditions, and KBC provides customer services to select the most suitable and economical bearings for their uses.

Prefixes

- CB** Inner/outer rings and rolling elements made of ceramic
- HB** Rolling elements made of ceramic

Suffixes

- SU** Stainless steel cage
- PT** Fluorine resin cage

▼ Comparisons between Ceramic and Steel Bearings

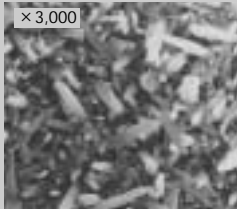
Kinds	Ceramic (Nitro-silicon)	Bearing Steel	Merits of Ceramic Material	Photography of Ceramic Tissue
Heat-resistance(°C)	800	120	Possible to use under high temperature	
Density(g/m ³)	3.2	7.8	Advantageous in high speeds	
Hardness(HV)	1800	750	Excellent abrasion-resistance	
Friction(no lubrication)	Small	Large	Possible to use without lubrication	
Magnetism	Not influenced	Strong influence	Smooth operation under strong magnetic field.	
Modulus of elasticity(kgf/mm ²)	3200	21000	Small contact deformation(Strong rigidity)	
Insulation	Insulator	Conductor	Can be used where high voltage or current electricity is flowing.	
Corrosion-resistance	Good	Poor	Can be mounted where corrosion problem exists	

KBC Vacuum Bearings



KBC Vacuum Bearings

Material Characteristics · Basic Designs · Lubrication · Tolerances

KBC vacuum bearings are coated with solid lubricant in vacuum, and they can be used for bearings required to be used in a vacuum environment, where ordinary bearings with ordinary lubricants can not be used. All the parts including inner/outer rings are made of stainless steel.

All of inner/outer rings, balls, and retainers of KBC vacuum bearings are coated with solid lubricant, and they provide excellent lubrication and durability in a vacuum operational environment.

KBC vacuum bearings are custom-made and supplied on request.

Material Characteristics

Both rings and rolling elements are made of martensite stainless steel (STS440C).

The martensite steels have the highest hardness values even among all kinds of stainless steels, and they also allow minimum amount of emissive gases. They are an excellent corrosion proof and radiation proof material, and they can be used under the wide range of operating temperatures(300~400°C under light loads).

For cages and shields, austenite stainless steels(STS304) are usually used.

Basic Designs

KBC vacuum bearings can be largely divided into 3 groups depending on their uses, namely, for clean, for extra high-quality clean, and for high temperatures.

The operating environment for vacuum bearings usually involves light loads and low speeds, and their inner/outer rings and rolling elements are usually made of martensite stainless steels, and their cages of austenite stainless steels.

Vacuum bearings for average clean can be used in the environment where free particles(About Class 100) do not cause that much of a problem, and those for extra high-quality clean can be used in the environment where even smaller particles cause serious problems, and those for high temperatures can be used under the operating temperature of up to 400°C.

Depending on the specific operating environments and conditions, these solid lubricants and coating methods for these vacuum bearings can be

revised on request. It is necessary to consult KBC to choose appropriate bearings that will suit the customers' distinct environment and purposes.

Lubrication

For materials for solid lubricants to be coated, silver(Ag), molybdenum disulfide(MoS₂), or PTFE are the usual choices, and they are coated by means of sputtering or ion-plating.

They each have distinct characteristics, so it is important to choose a proper solid lubricant for coating. And it is also possible to use different kinds of solid lubricants for different parts of bearings in combination. For example, different solid lubricants can be applied on each of raceway surface of inner/outer rings, balls, and others, so as to obtain maximum efficiency under the specific unusual operating environment.

Tolerances

KBC vacuum bearings of basic designs are machined to normal tolerances. The ones with finer tolerances can be custom-made on request.

For the exact tolerances of vacuum bearings, please contact KBC.

Prefixes

SA Bearings for special operating environment

Suffixes

SCXY

X: Coating materials

- B Pb
- G Ag
- M MoS₂
- P PTFE
- U Au

Y: Coating Parts

- Inner ring
- 1 Inner/outer rings
- 2 Outer ring
- 3 Inner/outer rings and rolling elements
- 4 Rolling elements
- 5 Inner/outer rings, rolling elements, and cages

Appendix

1. Conversion Table for International System of Units(SI Units) ..	228
2. Comparison Table for SI, CGS and Engineering Units	229
3. Codes for Multiples of 10 for SI Units	229
4. Conversion Table for Inch-mm	230
5. Conversion Table for °C - °F	231
6. Conversion Table for kg-lb	232
7. Conversion Table for N-kgf	233
8. Viscosity Conversion Table	234
9. Hardness Conversion Table	235
10. Tolerances for Shafts	236
11. Tolerances for Housing Holes	238
12. IT Classes for Basic Tolerances	240
13. Physical/Mechanical Characteristics of Metals	241

Appendix

1. Conversion Table for International System of Units(SI Units)

kinds	SI Units	Non-SI Units	Conversion Factor from SI Units	Kinds	SI Units	Non-SI units	Conversion Factor from SI Units
Angle	rad	° ' "	$180/\pi$ $10800/\pi$ $648000/\pi$	Pressure	Pa (N/m²)	kgf/m ² mHzO mmHg Torr bar atm	1/9.806 65 $1/(9.806 65 \times 10^3)$ $760/(1.01325 \times 10^5)$ $760/(1.01325 \times 10^5)$ 10^{-5} $760/(1.01325 \times 10^5)$
Length	m	μ Å	10^6 10^{10}	Work	J (N · m)	erg calIT kgf · m kW · h PS · h	10^7 1/4.186 8 1/9.806 65 $1/(3.6 \times 10^6)$ $\approx 3.776 72 \times 10^{-7}$
Area	m²	a ha	10^{-2} 10^{-4}	Power Work Ratio	W (J/s)	kgf · m/s kcal/h PS	1/9.806 65 1/1.163 $\approx 1/735.498 8$
Volume	m³	l, L dl, dL	10^3 10^4	Viscosity Index	Pa · s	P	10
Time	s	min h d	1/60 1/3 600 1/86 400	Kinematic, Viscosity Index	m²/s	St cSt	10^4 10^6
Frequency	Hz	s ⁻¹	1	Temperature Difference	K	°C	주 ¹⁾ 참조
Revolutions	s⁻¹	rpm	60	Electric Current	A	A	1
Acceleration	m/s	km/h kn	$3 600/1 000$ $3 600/1 852$	Electric Voltage	V	(W/A)	1
Acceleration	m/s²	Gal G	10^2 1/9.806 65	Force of Magnetic Field	A/m	Oe	$4\pi/10^3$
Weight	kg	t	10^{-3}	Density of Magnetic Speed	T	Gs γ	10^4 10^9
Force	N	kgf tf dyn	1/9.806 65 $1/(9.806 65 \times 10^3)$ 10^5	Electric Resistance	Ω	(V/A)	1
Torque, Force Moment	N · m	kgf · m	1/9.806 65				
Stress	Pa (N/m²)	kgf · m ² kgf · mm ²	$1/(9.806 65 \times 10^4)$ $1/(9.806 65 \times 10^6)$				

Annotations

1) : Temperature conversion from T K to X°C is done by using the formula, $X = T - 273.15$, but in case of temperature differences, $\Delta \gamma = \Delta x$.

Conversion Example 1N = 1/9.806 65kgf

2. Comparison Table for SI CGS and Engineering Units

System	Length	Mass	Time	Temperature	Acceleration	Force	Stress	Pressure	Work	Power
SI	m	kg	s	K	m/s ²	N	Pa	Pa	J	W
CGS System	cm	g	s	°C	Gal	dyn	dyn/cm ²	dyn/cm ²	erg	erg/s
Engineering Units	m	kgf·s ² /m	s	°C	m/s ²	kgf	kgf/m ²	kgf/m ²	kgf·m	kgf·m/s

3. Codes for Multiples of 10 for SI Units

Multiples of 10	Name	Code	Multiples of 10	Name	Code
10 ¹⁸	Exa	E	10 ⁻¹	Deci	d
10 ¹⁵	Peta	P	10 ⁻²	Centi	c
10 ¹²	Tera	T	10 ⁻³	Milli	m
10 ⁹	Giga	G	10 ⁻⁶	Micro	μ
10 ⁶	Mega	M	10 ⁻⁹	Nano	n
10 ³	Kilo	k	10 ⁻¹²	Pico	p
10 ²	Hecto	h	10 ⁻¹⁵	Femto	f
10 ¹	Deca	da	10 ⁻¹⁸	Ato	a

Appendix

4. Conversion Table for Inch-mm

1" = 25.4mm

inch	0	1	2	3	4	5	6	7	8	9	10	
Fractions Decimals	mm											
0	0.000000	0.000	25.400	50.800	76.200	101.600	127.000	152.400	177.800	203.200	228.600	254.000
1/64	0.015625	0.397	25.797	51.197	76.597	101.997	127.397	152.797	178.197	203.597	228.997	254.397
1/32	0.031250	0.794	26.194	51.594	76.994	102.394	127.794	153.194	178.594	203.994	229.394	254.794
3/64	0.046875	1.191	26.591	51.991	77.391	102.791	128.191	153.591	178.991	204.391	229.791	255.191
1/16	0.062500	1.588	26.988	52.388	77.788	103.188	128.588	153.988	179.388	204.788	230.188	255.588
5/64	0.078125	1.984	27.384	52.784	78.184	103.584	128.984	154.384	179.784	205.184	230.584	255.984
3/32	0.093750	2.381	27.781	53.181	78.581	103.981	129.381	154.781	180.181	205.581	230.981	256.381
7/64	0.109375	2.778	28.178	53.578	78.978	104.378	129.778	155.178	180.579	205.978	231.378	256.778
1/8	0.125000	3.175	28.575	53.975	79.375	104.775	130.175	155.575	180.975	206.375	231.775	257.175
9/64	0.140625	3.572	28.972	54.372	79.772	105.172	130.572	155.972	181.372	206.772	232.172	257.572
5/32	0.156250	3.969	29.369	54.769	80.169	105.569	130.969	156.369	181.769	207.169	232.569	257.969
11/64	0.171875	4.366	29.766	55.166	80.566	105.966	131.366	156.766	182.166	207.566	232.966	258.366
3/16	0.187500	4.762	30.162	55.562	80.962	106.362	131.762	157.162	182.562	207.962	233.362	258.762
13/64	0.203125	5.159	30.559	55.959	81.359	106.759	132.159	157.559	182.959	208.359	233.759	259.159
7/32	0.218750	5.556	30.956	56.356	81.756	107.156	132.556	157.956	183.356	208.756	234.156	259.556
15/64	0.234375	5.953	31.353	56.753	82.153	107.553	132.953	158.353	183.753	209.153	234.553	259.953
1/4	0.250000	6.350	31.750	57.150	82.550	107.950	133.350	158.750	184.150	209.550	234.950	260.350
17/64	0.265625	6.747	32.147	57.547	82.947	108.347	133.747	159.147	184.547	209.947	235.347	260.747
9/32	0.281250	7.144	32.544	57.944	83.344	108.744	134.144	159.544	184.944	210.344	235.744	261.144
19/64	0.296875	7.541	32.941	58.341	83.741	109.141	134.541	159.941	185.341	210.741	236.141	261.541
5/16	0.312500	7.938	33.338	58.738	84.138	109.538	134.938	160.338	185.738	211.138	236.538	261.938
21/64	0.328125	8.334	33.734	59.134	84.534	109.934	135.334	160.734	186.134	211.534	236.934	262.334
11/32	0.343750	8.731	34.131	59.531	84.931	110.331	135.731	161.131	186.531	211.931	237.331	262.731
23/64	0.359375	9.128	34.528	59.928	85.328	110.728	136.128	161.528	186.928	212.328	237.728	263.128
3/8	0.375000	9.525	34.925	60.325	87.725	111.125	136.525	161.925	187.325	212.725	238.125	263.525
25/64	0.390625	9.922	35.322	60.722	86.122	111.522	136.922	162.322	187.722	213.122	238.522	263.922
13/32	0.406250	10.319	35.719	61.119	86.519	111.919	137.319	162.719	188.119	213.519	238.919	264.319
27/64	0.421875	10.716	36.116	61.516	86.916	112.316	137.716	163.116	188.516	213.916	239.316	264.716
7/16	0.437500	11.112	36.512	61.912	87.312	112.712	138.112	163.512	188.912	214.312	239.712	265.112
29/64	0.453125	11.509	36.909	62.309	87.709	113.109	138.509	163.909	189.309	214.709	240.109	265.509
15/32	0.468750	11.906	37.306	62.706	88.106	113.506	138.906	164.306	189.706	215.106	240.506	265.906
31/64	0.484375	12.303	37.703	63.103	88.503	113.903	139.303	164.703	190.103	215.503	240.903	266.303
1/2	0.500000	12.700	38.100	63.500	88.900	114.300	139.700	165.100	190.500	215.900	241.300	266.700
33/64	0.515625	13.097	38.497	63.897	89.297	114.697	140.097	165.497	190.897	216.297	241.697	267.097
17/32	0.531250	13.494	38.894	64.294	89.694	115.094	140.494	165.894	191.294	216.694	242.094	267.494
35/64	0.546875	13.891	39.291	64.691	90.091	115.491	140.891	166.291	191.691	217.091	242.491	267.891
9/16	0.562500	14.288	39.688	65.088	90.488	115.888	141.288	166.688	192.088	217.488	242.888	268.288
37/64	0.578125	14.684	40.084	65.484	90.884	116.284	141.684	167.084	192.484	217.884	243.284	268.684
19/32	0.593750	15.081	40.481	65.881	91.281	116.681	142.081	167.481	192.881	218.281	243.681	269.081
39/64	0.609375	15.478	40.878	66.278	91.678	117.078	142.478	167.878	193.278	218.678	244.078	269.478
5/8	0.625000	15.875	41.275	66.675	92.075	117.475	142.875	168.275	193.675	219.075	244.475	269.875
41/64	0.640625	16.272	41.672	67.072	92.472	117.872	143.272	168.672	194.072	219.472	244.872	270.272
21/32	0.656250	16.669	42.069	67.469	92.869	118.269	143.669	169.069	194.469	219.869	245.269	270.669
43/64	0.671875	17.066	42.466	67.866	93.266	118.666	144.066	169.466	194.866	220.266	245.666	271.066
11/16	0.687500	17.462	42.862	68.262	93.662	119.062	144.462	169.862	195.262	220.662	246.062	271.462
45/64	0.703125	17.859	43.259	68.659	94.059	119.459	144.859	170.259	195.659	221.059	246.459	271.859
23/32	0.718750	18.256	43.656	69.056	94.456	119.856	145.256	170.656	196.056	221.456	246.856	272.256
47/64	0.734375	18.653	44.053	69.453	94.853	120.253	145.653	171.053	196.453	221.853	247.253	272.653
3/4	0.750000	19.050	44.450	69.850	95.250	120.650	146.050	171.450	196.850	222.250	247.650	273.050
49/64	0.765625	19.447	44.847	70.247	95.647	121.047	146.447	171.847	197.247	222.647	248.047	273.447
25/32	0.781250	19.844	45.244	70.644	96.044	121.444	146.844	172.244	197.644	223.044	248.444	273.844
51/64	0.796875	20.241	45.641	71.041	96.441	121.841	147.241	172.641	198.041	223.441	248.841	274.241
13/16	0.812500	20.638	46.038	71.438	96.838	122.238	147.638	173.038	198.438	223.838	249.238	274.638
53/64	0.828125	21.034	46.434	71.834	97.234	122.634	148.034	173.434	198.834	224.234	249.634	275.034
27/32	0.843750	21.431	46.831	72.231	97.631	123.031	148.431	173.831	199.231	224.631	250.031	275.431
55/64	0.859375	21.828	47.228	72.628	98.028	123.428	148.828	174.228	199.628	225.028	250.428	275.828
7/8	0.875000	22.225	47.625	73.025	98.425	123.825	149.225	174.625	200.025	225.425	250.825	276.225
57/64	0.890625	22.622	48.022	73.422	98.822	124.222	149.622	175.022	200.422	225.822	251.222	276.622
29/32	0.906250	23.019	48.419	73.819	99.219	124.619	150.019	175.419	200.819	226.219	251.619	277.019
59/64	0.921875	23.416	48.816	74.216	99.616	125.016	150.416	175.816	201.216	226.616	252.016	277.416
15/16	0.937500	23.812	49.212	74.612	100.012	125.412	150.812	176.212	201.612	227.012	252.412	277.812
61/64	0.953125	24.209	49.609	75.009	100.409	125.809	151.209	176.609	202.009	227.409	252.809	278.209
31/32	0.968750	24.606	50.006	75.406	100.806	126.206	151.606	177.006	202.406	227.806	253.206	278.606
63/64	0.984375	25.003	50.403	75.803	101.203	126.603	152.003	177.403	202.803	228.203	253.603	279.003

5. Conversion Table for °C - °F

0°C=32°F
0°F=-17.8°C

°C		°F	°C		°F	°C		°F	°C		°F
-73.3	-100	-148.0	0.0	32	89.6	21.7	71	159.8	43.3	110	230
-62.2	-80	-112.0	0.6	33	91.4	22.2	72	161.6	46.1	115	239
-51.1	-60	-76.0	1.1	34	93.2	22.8	73	163.4	48.9	120	248
-40.0	-40	-40.0	1.7	35	95.0	23.3	74	165.2	51.7	125	257
-34.4	-30	-22.0	2.2	36	96.8	23.9	75	167.0	54.4	130	266
-28.9	-20	-4.0	2.8	37	98.6	24.4	76	168.8	57.2	135	275
-23.3	-10	14.0	3.3	38	100.4	25.0	77	170.6	60.0	140	284
-17.8	0	32.0	3.9	39	102.2	25.6	78	172.4	65.6	150	302
-17.2	1	33.8	4.4	40	104.0	26.1	79	174.2	71.1	160	320
-16.7	2	35.6	5.0	41	105.8	26.7	80	176.0	76.7	170	338
-16.1	3	37.4	5.6	42	107.6	27.2	81	177.8	82.2	180	356
-15.6	4	39.2	6.1	43	109.4	27.8	82	179.6	87.8	190	374
-15.0	5	41.0	6.7	44	111.2	28.3	83	181.4	93.3	200	392
-14.4	6	42.8	7.2	45	113.0	28.9	84	183.2	98.9	210	410
-13.9	7	44.6	7.8	46	114.8	29.4	85	185.0	104.4	220	428
-13.3	8	46.4	8.3	47	116.6	30.0	86	186.8	110.0	230	446
-12.8	9	48.2	8.9	48	118.4	30.6	87	188.6	115.6	240	464
-12.2	10	50.0	9.4	49	120.2	31.1	88	190.4	121.1	250	482
-11.7	11	51.8	10.0	50	122.0	31.7	89	192.2	148.9	300	572
-11.1	12	53.6	10.6	51	123.8	32.2	90	194.0	176.7	350	662
-10.6	13	55.4	11.1	52	125.6	32.8	91	195.8	204	400	752
-10.0	14	57.2	11.7	53	127.4	33.3	92	197.6	232	450	842
-9.4	15	59.0	12.2	54	129.2	33.9	93	199.4	260	500	932
-8.9	16	60.8	12.8	55	131.0	34.4	94	201.2	288	550	1022
-8.3	17	62.6	13.3	56	132.8	35.0	95	203.0	316	600	1112
-7.8	18	64.4	13.9	57	134.6	35.6	96	204.8	343	650	1202
-7.2	19	66.2	14.4	58	136.4	36.1	97	206.6	371	700	1292
-6.7	20	68.0	15.0	59	138.2	36.7	98	208.4	399	750	1382
-6.1	21	69.8	15.6	60	140.0	37.2	99	210.2	427	800	1472
-5.6	22	71.6	16.1	61	141.8	37.8	100	212.0	454	850	1562
-5.0	23	73.4	16.7	62	143.6	38.3	101	213.8	482	900	1652
-4.4	24	75.2	17.2	63	145.4	38.9	102	215.6	510	950	1742
-3.9	25	77.0	17.8	64	147.2	39.4	103	217.4	538	1000	1832
-3.3	26	78.8	18.3	65	149.0	40.0	104	219.2	593	1100	2012
-2.8	27	80.6	18.9	66	150.8	40.6	105	221.0	649	1200	2192
-2.2	28	82.4	19.4	67	152.6	41.1	106	222.8	704	1300	2372
-1.7	29	84.2	20.0	68	154.4	41.7	107	224.6	760	1400	2552
-1.1	30	86.0	20.6	69	156.2	42.2	108	226.4	816	1500	2732
-0.6	31	87.8	21.1	70	158.0	42.8	109	228.2	871	1600	2912

$$C = \frac{5}{9}(F-32)$$

$$F = 32 + \frac{9}{5}C$$

Appendix

6. Conversion Table for kg-lb

1kg = 2.2046226 lb

1lb = 0.45359237kg

kg		lb	kg		lb	kg		lb
0.454	1	2.205	15.422	34	74.957	30.391	67	147.71
0.907	2	4.409	15.876	35	77.162	30.844	68	149.91
1.361	3	6.614	16.329	36	79.366	31.298	69	152.12
1.814	4	8.818	16.783	37	81.571	31.751	70	154.32
2.268	5	11.023	17.237	38	83.776	32.205	71	156.53
2.722	6	13.228	17.690	39	85.980	32.659	72	158.73
3.175	7	15.432	18.144	40	88.185	33.112	73	160.94
3.629	8	17.637	18.597	41	90.390	33.566	74	163.14
4.082	9	19.842	19.051	42	92.594	34.019	75	165.35
4.536	10	22.046	19.504	43	94.799	34.473	76	167.55
4.990	11	24.251	19.958	44	97.003	34.927	77	169.76
5.443	12	26.455	20.412	45	99.208	35.380	78	171.96
5.897	13	28.660	20.865	46	101.41	35.834	79	174.17
6.350	14	30.865	21.319	47	103.62	36.287	80	176.37
6.804	15	33.069	21.772	48	105.82	36.741	81	178.57
7.257	16	35.274	22.226	49	108.03	37.195	82	180.78
7.711	17	37.479	22.680	50	110.23	37.648	83	182.98
8.165	18	39.683	23.133	51	112.44	38.102	84	185.19
8.618	19	41.888	23.587	52	114.64	38.555	85	187.39
9.072	20	44.092	24.040	53	116.84	39.009	86	189.60
9.525	21	46.297	24.494	54	119.05	39.463	87	191.80
9.979	22	48.502	24.948	55	121.25	39.916	88	194.01
10.433	23	50.706	25.401	56	123.46	40.370	89	196.21
10.886	24	52.911	25.855	57	125.66	40.823	90	198.42
11.340	25	55.116	26.308	58	127.87	41.277	91	200.62
11.793	26	57.320	26.762	59	130.07	41.730	92	202.83
12.247	27	59.525	27.216	60	132.28	42.184	93	205.03
12.701	28	61.729	27.669	61	134.48	42.638	94	207.23
13.154	29	63.934	28.123	62	136.69	43.091	95	209.44
13.608	30	66.139	28.576	63	138.89	43.545	96	211.64
14.061	31	68.343	29.030	64	141.10	43.998	97	213.85
14.515	32	70.548	29.484	65	143.30	44.452	98	216.05
14.969	33	72.753	29.937	66	145.51	44.906	99	218.26

7. Conversion Table for N-kgf

1N = 0.1019716kgf

1kgf = 9.80665N

N		kgf	N		kgf	N		kgf
9.8066	1	0.1020	333.43	34	3.4670	657.05	67	6.8321
19.613	2	0.2039	343.23	35	3.5690	666.85	68	6.9341
29.420	3	0.3059	353.04	36	3.6710	676.66	69	7.0360
39.227	4	0.4079	362.85	37	3.7729	686.47	70	7.1380
49.033	5	0.5099	372.65	38	3.8749	696.27	71	7.2400
58.840	6	0.6118	382.46	39	3.9769	706.08	72	7.3420
68.647	7	0.7138	392.27	40	4.0789	715.89	73	7.4439
78.453	8	0.8158	402.07	41	4.1808	725.69	74	7.5459
88.260	9	0.9177	411.88	42	4.2828	735.50	75	7.6479
98.066	10	1.0197	421.69	43	4.3848	745.31	76	7.7498
107.87	11	1.1217	431.49	44	4.4868	755.11	77	7.8518
117.68	12	1.2237	441.30	45	4.5887	764.92	78	7.9538
127.49	13	1.3256	451.11	46	4.6907	774.73	79	8.0558
137.29	14	1.4276	460.91	47	4.7927	784.53	80	8.1577
147.10	15	1.5296	470.72	48	4.8946	794.34	81	8.2597
156.91	16	1.6315	480.53	49	4.9966	804.15	82	8.3617
166.71	17	1.7335	490.33	50	5.0986	813.95	83	8.4636
176.52	18	1.8355	500.14	51	5.2006	823.76	84	8.5656
186.33	19	1.9375	509.95	52	5.3025	833.57	85	8.6676
196.13	20	2.0394	519.75	53	5.4045	843.37	86	8.7696
205.94	21	2.1414	529.56	54	5.5065	853.18	87	8.8715
215.75	22	2.2434	539.37	55	5.6084	862.99	88	8.9735
225.55	23	2.3453	549.17	56	5.7104	872.79	89	9.0755
235.36	24	2.4473	558.98	57	5.8124	882.60	90	9.1774
245.17	25	2.5493	568.79	58	5.9144	892.41	91	9.2794
254.97	26	2.6513	578.59	59	6.0163	902.21	92	9.3814
264.78	27	2.7532	588.40	60	6.1183	912.02	93	9.4834
274.59	28	2.8552	598.21	61	6.2203	921.83	94	9.5853
284.39	29	2.9572	608.01	62	6.3222	931.63	95	9.6873
294.20	30	3.0591	617.82	63	6.4242	941.44	96	9.7893
304.01	31	3.1611	627.63	64	6.5262	951.25	97	9.8912
313.81	32	3.2631	637.43	65	6.6282	961.05	98	9.9932
323.62	33	3.3651	647.24	66	6.7301	970.86	99	10.095

Appendix

8. Viscosity Conversion Table

1mm²/s = 1cSt

Kinematic (mm ² /s)	Boit SUS (sec)		NO. 1 R (sec)		Angler E (deg)	Kinematic (mm ² /s)	Boit SUS (Sec.)		NO. 1 R (Sec.)		Angler E (deg)
	100 °F	210 °F	50 °C	100 °C			100 °F	210 °F	50 °C	100 °C	
2	32.6	32.8	30.8	31.2	1.14	35	163	164	144	147	4.70
3	36.0	36.3	33.3	33.7	1.22	36	168	170	148	151	4.83
4	39.1	39.4	35.9	36.5	1.31	37	172	173	153	155	4.96
5	42.3	42.6	38.5	39.1	1.40	38	177	178	156	159	5.08
6	45.5	45.8	41.1	41.7	1.48	39	181	183	160	164	5.21
7	48.7	49.0	43.7	44.3	1.56	40	186	187	164	168	5.34
8	52.0	52.4	46.3	47.0	1.65	41	190	192	168	172	5.47
9	55.4	55.8	49.1	50.0	1.75	42	195	196	172	176	5.59
10	58.8	59.2	52.1	52.9	1.84	43	199	201	176	180	5.72
11	62.3	62.7	55.1	56.0	1.93	44	204	205	180	185	5.85
12	65.9	66.4	58.2	59.1	2.02	45	208	210	184	189	5.98
13	69.6	70.1	61.4	62.3	2.12	46	213	215	188	193	6.11
14	73.4	73.9	64.7	65.6	2.22	47	218	219	193	197	6.24
15	77.2	77.7	68.0	69.1	2.32	48	222	224	197	202	6.37
16	81.1	81.7	71.5	72.6	2.43	49	227	228	201	206	6.50
17	85.1	85.7	75.0	76.1	2.54	50	231	233	205	210	6.63
18	89.2	89.8	78.6	79.7	2.64	55	254	256	225	231	7.24
19	93.3	94.0	82.1	83.6	2.76	60	277	279	245	252	7.90
20	97.5	98.2	85.8	87.4	2.87	65	300	302	266	273	8.55
21	102	102	89.5	91.3	2.98	70	323	326	286	294	9.21
22	106	107	93.3	95.1	3.10	75	346	349	306	315	9.89
23	110	111	97.1	98.9	3.22	80	371	373	326	336	10.5
24	115	115	101	103	3.34	85	394	397	347	357	11.2
25	119	120	105	107	3.46	90	417	420	367	378	11.8
26	123	124	109	111	3.58	95	440	443	387	399	12.5
27	128	129	112	115	3.70	100	464	467	408	420	13.2
28	132	133	116	119	3.82	120	556	560	490	504	15.8
29	137	138	120	123	3.95	140	649	653	571	588	18.4
30	141	142	124	127	4.07	160	742	747	653	672	21.1
31	145	146	128	131	4.20	180	834	840	734	757	23.7
32	150	150	132	135	4.32	200	927	933	816	841	26.3
33	154	155	136	139	4.45	250	1 159	1 167	1 020	1 051	32.9
34	159	160	140	143	4.57	300	1 391	1 400	1 224	1 241	39.5

9. Hardness Conversion Table

Rockwell Hardness C Scale (150 kgf)	Vickers Hardness	Brinell Hardness		Rockwell Hardness		Shore Hardness
		Standard Ball	Tungsten Carbide Ball	A Scale (60 kgf)	B Scale (100 kgf)	
68	940	-	-	85.6	-	97
67	900	-	-	85.0	-	95
66	865	-	-	84.5	-	92
65	832	-	739	83.9	-	91
64	800	-	722	83.4	-	88
63	772	-	705	82.8	-	87
62	746	-	688	82.3	-	85
61	720	-	670	81.8	-	83
60	697	-	654	81.2	-	81
59	674	-	634	80.7	-	80
58	653	-	615	80.1	-	78
57	633	-	595	79.6	-	76
56	613	-	577	79.0	-	75
55	595	-	560	78.5	-	74
54	577	-	543	78.0	-	72
53	560	-	525	77.4	-	71
52	544	500	512	76.8	-	69
51	528	487	496	76.3	-	68
50	513	475	481	75.9	-	67
49	498	464	469	72.5	-	66
48	484	451	455	74.7	-	64
47	471	442	443	74.1	-	63
46	458	432	432	73.6	-	62
45	446	421	421	73.1	-	60
44	434	409	409	72.5	-	58
43	423	400	400	72.0	-	57
42	412	390	390	71.5	-	56
41	402	381	381	70.9	-	55
40	392	371	371	70.4	-	54
39	382	362	362	69.9	-	52
38	372	353	353	69.4	-	51
37	363	344	344	68.9	-	50
36	354	336	336	68.4	(109.0)	49
35	345	327	327	67.9	(108.5)	48
34	336	319	319	67.4	(108.0)	47
33	327	311	311	66.8	(107.5)	46
32	318	301	301	66.3	(107.0)	44
31	310	294	294	65.8	(106.0)	43
30	302	286	286	65.3	(105.5)	42
29	294	279	279	64.7	(104.5)	41
28	286	271	271	64.3	(104.0)	41
27	279	264	264	63.8	(103.0)	40
26	272	258	258	63.3	(102.5)	38
25	266	253	253	62.8	(101.5)	38
24	260	247	247	62.4	(101.0)	37
23	254	243	243	62.0	100.0	36
22	248	237	237	61.5	99.0	35
21	243	231	231	61.0	98.5	35
20	238	226	226	60.5	97.8	34
(18)	230	219	219	-	96.7	33
(16)	222	212	212	-	95.5	32
(14)	213	203	203	-	93.9	31
(12)	204	194	194	-	92.3	29
(10)	196	187	187	-	90.7	28
(8)	188	179	179	-	89.5	27
(6)	180	171	171	-	87.1	26
(4)	173	165	165	-	85.5	25
(2)	166	158	158	-	83.5	24
(0)	160	152	152	-	81.7	24

Appendix

10. Tolerances for Shafts

Nominal Shaft Diameter(mm)		Bearings													
Over	To	Δ_{dmp})	d6	e6	f6	g5	g6	h5	h6	h7	h8	h9	h10	js5	js6
3	6	0 -8	-30 -38	-20 -28	-10 -18	-4 -9	-4 -12	0 -5	0 -8	0 -12	0 -18	0 -30	0 -48	±2.5	±4
6	10	0 -8	-40 -49	-25 -34	-13 -22	-5 -11	-5 -14	0 -6	0 -9	0 -15	0 -22	0 -36	0 -58	±3	±4.5
10	18	0 -8	-50 -61	-32 -43	-16 -27	-6 -14	-6 -17	0 -8	0 -11	0 -18	0 -27	0 -43	0 -70	±4	±5.5
18	30	0 -10	-65 -78	-40 -53	-20 -33	-7 -16	-7 -20	0 -9	0 -13	0 -21	0 -33	0 -52	0 -84	±4.5	±6.5
30	50	0 -12	-80 -96	-50 -66	-25 -41	-9 -20	-9 -25	0 -11	0 -16	0 -25	0 -39	0 -62	0 -100	±5.5	±8
50	80	0 -15	-100 -119	-60 -79	-30 -49	-10 -23	-10 -29	0 -13	0 -19	0 -30	0 -46	0 -74	0 -120	±6.5	±9.5
80	120	0 -20	-120 -142	-72 -94	-36 -58	-12 -27	-12 -34	0 -15	0 -22	0 -35	0 -54	0 -87	0 -140	±7.5	±11
120	180	0 -25	-145 -170	-85 -110	-43 -68	-14 -32	-14 -39	0 -18	0 -25	0 -40	0 -63	0 -100	0 -160	±9	±12.5
180	250	0 -30	-170 -199	-100 -129	-50 -79	-15 -35	-15 -44	0 -20	0 -29	0 -46	0 -72	0 -115	0 -185	±10	±14.5
250	315	0 -35	-190 -222	-110 -142	-56 -88	-17 -40	-17 -49	0 -23	0 -32	0 -52	0 -81	0 -130	0 -210	±11.5	±16
315	400	0 -40	-210 -246	-125 -161	-62 -98	-18 -43	-18 -54	0 -25	0 -36	0 -57	0 -89	0 -140	0 -230	±12.5	±18
400	500	0 -45	-230 -270	-135 -175	-68 -108	-20 -47	-20 -60	0 -27	0 -40	0 -63	0 -97	0 -155	0 -250	±13.5	±20
500	630	0 -50	-260 -304	-145 -189	-76 -120	-	-22 -66	-	0 -44	0 -70	0 -110	0 -175	0 -280	-	±22
630	800	0 -75	-290 -340	-160 -210	-80 -130	-	-24 -74	-	0 -50	0 -80	0 -125	0 -200	0 -320	-	±25
800	1000	0 -100	-320 -376	-170 -226	-86 -142	-	-26 -82	-	0 -56	0 -90	0 -140	0 -230	0 -360	-	±28
1000	1250	0 -125	-350 -416	-195 -261	-98 -164	-	-28 -94	-	0 -66	0 -105	0 -165	0 -260	0 -420	-	±33
1250	1600	0 -160	-390 -468	-220 -298	-110 -188	-	-30 -108	-	0 -78	0 -125	0 -195	0 -310	0 -500	-	±39
1600	2000	0 -200	-430 -522	-240 -332	-120 -212	-	-32 -124	-	0 -92	0 -150	0 -230	0 -370	0 -600	-	±46

1): Average outer diameter tolerances on the plane (Tolerance Class O)

Unit : μm

j5	j6	j7	k5	k6	k7	m5	m6	n6	p6	r6	r7	Nominal Shaft Diameter(mm)	
												Over	To
+3 -2	+6 -2	+8 -4	+6 +1	+9 +1	+13 +1	+9 +4	+12 +4	+16 +8	+20 +12	+23 +15	+27 +15	3	6
+4 -2	+7 -2	+10 -5	+7 +1	+10 +1	+16 +1	+12 +6	+15 +6	+19 +10	+24 +15	+28 +19	+34 +19	6	10
+5 -3	+8 -3	+12 -6	+9 +1	+12 +1	+19 +1	+15 +7	+18 +7	+23 +12	+29 +12	+34 +18	+41 +23	10	18
+5 -4	+9 -4	+13 -8	+11 +2	+15 +2	+23 +2	+17 +8	+21 +8	+28 +15	+35 +22	+41 +28	+49 +28	18	30
+6 -5	+11 -5	+15 -10	+13 +2	+18 +2	+27 +2	+20 +9	+25 +9	+33 +17	+42 +26	+50 +34	+59 +34	30	50
+6 -7	+12 -7	+18 -12	+15 +2	+21 +2	+32 +2	+24 +11	+30 +11	+39 +20	+51 +32	+60 +41	+71 +41	50	65
+6 -9	+13 -9	+20 -15	+18 +3	+25 +3	+38 +3	+28 +13	+35 +13	+45 +23	+59 +37	+62 +76	+86 +89	80	100
										+54 +43	+54 +86	100	120
										+63 +90	+63 +105	120	140
+7 -11	+14 -11	+22 -18	+21 +3	+28 +3	+43 +3	+33 +15	+40 +15	+52 +27	+68 +43	+65 +93	+65 +108	140	160
										+68 +113	+68 +130	160	180
										+84 +106	+84 +123	180	200
+7 -13	+16 -13	+25 -21	+24 +4	+33 +4	+50 +4	+37 +17	+46 +17	+60 +31	+79 +50	+77 +109	+77 +126	200	225
										+80 +113	+80 +130	225	250
+7 -16	+16 -16	+26 -26	+27 +4	+36 +4	+56 +4	+43 +20	+52 +20	+66 +34	+88 +56	+94 +130	+94 +150	250	280
										+98 +144	+98 +165	280	315
+7 -18	+18 -18	+29 -28	+29 +4	+40 +4	+61 +4	+46 +21	+57 +21	+73 +37	+98 +62	+108 +150	+108 +171	315	355
										+114 +166	+114 +189	355	400
+7 -20	+20 -20	+31 -32	+32 +5	+45 +5	+68 +5	+50 +23	+63 +23	+80 +40	+108 +68	+126 +172	+126 +195	400	450
										+132 +194	+132 +220	450	500
-	-	-	-	+44 0	+70 0	-	+70 +26	+88 +44	+122 +78	+150 +199	+150 +225	500	560
										+155 +225	+155 +255	560	630
-	-	-	-	+50 0	+80 0	-	+80 +30	+100 +50	+138 +88	+175 +235	+175 +265	630	710
										+185 +266	+185 +300	710	800
-	-	-	-	+56 0	+90 0	-	+90 +34	+112 +56	+156 +100	+210 +276	+210 +310	800	900
										+220 +316	+220 +355	900	1000
-	-	-	-	+66 0	+105 0	-	+106 +40	+132 +66	+186 +120	+250 +326	+250 +365	1000	1120
										+260 +378	+260 +425	1120	1250
-	-	-	-	+78 0	+125 0	-	+126 +48	+156 +78	+218 +140	+300 +408	+300 +455	1250	1400
										+330 +462	+330 +520	1400	1600
-	-	-	-	+92 0	+150 0	-	+150 +58	+184 +92	+262 +170	+370 +492	+370 +550	1600	1800
										+400 +462	+400 +520	1800	2000

Appendix

11. Tolerances for Housing Holes

Nominal Shaft Diameter(mm)		Bearing	E6	F6	F7	G6	G7	H6	H7	H8	J6	J7	JS6	JS7
Over	To	$\Delta_{Dmp}^1)$												
10	18	0 -8	+43 +32	+27 +16	+34 +16	+17 +6	+24 +6	+11 0	+18 0	+27 0	+6 -5	+10 -8	±5.5	±9
18	30	0 -9	+53 +40	+33 +20	+41 +20	+20 +7	+28 +7	+13 0	+21 0	+33 0	+8 -5	+12 -9	±6.5	±10
30	50	0 -11	+66 +50	+41 +25	+50 +25	+25 +9	+34 +9	+16 0	+25 0	+39 0	+10 -6	+14 -11	±8	±12
50	80	0 -13	+79 +60	+49 +30	+60 +30	+29 +10	+40 +10	+19 0	+30 0	+46 0	+13 -6	+18 -12	±9.5	±15
80	120	0 -15	+94 +72	+58 +36	+71 +36	+34 +12	+47 +12	+22 0	+35 0	+54 0	+16 -6	+22 -13	±11	±17
120	150	0 -18	+110 +85	+68 +43	+83 +43	+39 +14	+54 +14	+25 0	+40 0	+63 0	+18 -7	+26 -14	±12.5	±20
150	180	0 -25												
180	250	0 -30	+129 +100	+79 +50	+96 +50	+44 +15	+61 +15	+29 0	+46 0	+72 0	+22 -7	+30 -16	±14.5	±23
250	315	0 -35	+142 +110	+88 +56	+108 +56	+49 +17	+69 +17	+32 0	+52 0	+81 0	+25 -7	+36 -16	±16	±26
315	400	0 -40	+161 +125	+98 +62	+119 +62	+54 +18	+75 +18	+36 0	+57 0	+89 0	+29 -7	+39 -18	±18	±28
400	500	0 -45	+175 +135	+108 +68	+131 +68	+60 +20	+83 +20	+40 0	+63 0	+97 0	+33 -7	+43 -20	±20	±31
500	630	0 -50	+189 +145	+120 +76	+146 +76	+66 +22	+92 +22	+44 0	+70 0	+110 0	-	-	±22	±35
630	800	0 -75	+210 +160	+130 +80	+160 +80	+74 +24	+104 +24	+50 0	+80 0	+125 0	-	-	±25	±40
800	1000	0 -100	+226 +170	+142 +86	+176 +86	+82 +26	+116 +26	+56 0	+90 0	+140 0	-	-	±28	±45
1000	1250	0 -125	+261 +195	+164 +98	+203 +98	+94 +28	+133 +28	+66 0	+105 0	+165 0	-	-	±33	±52
1250	1600	0 -160	+298 +220	+188 +110	+235 +110	+108 +30	+155 +30	+78 0	+125 0	+195 0	-	-	±39	±62
1600	2000	0 -200	+332 +240	+212 +120	+270 +120	+124 +32	+182 +32	+92 0	+150 0	+230 0	-	-	±46	±75
2000	2500	0 -250	+370 +260	+240 +130	+305 +130	+144 +34	+209 +34	+110 0	+175 0	+280 0	-	-	±55	±87

1): Average outer diameter tolerances on the plane(Tolerance Class O)

Unit : μm

K5	K6	K7	M5	M6	M7	N5	N6	N7	P6	P7	Nominal Shaft Diameter(mm)	
											Over	To
+2 -6	+2 -9	+6 -12	-4 -12	-4 -15	0 -18	-9 -17	-9 -20	-5 -23	-15 -26	-11 -29	10	18
+1 -8	+2 -11	+6 -15	-5 -14	-4 -17	0 -21	-12 -21	-11 -24	-7 -28	-18 -31	-14 -35	18	30
+2 -9	+3 -13	+7 -18	-5 -16	-4 -20	0 -25	-13 -24	-12 -28	-8 -33	-21 -37	-17 -42	30	50
+3 -10	+4 -15	+9 -21	-6 -19	-5 -24	0 -30	-15 -28	-14 -33	-9 -39	-26 -45	-21 -51	50	80
+2 -13	+4 -18	+10 -25	-8 -23	-6 -28	0 -35	-18 -33	-16 -38	-10 -45	-30 -52	-24 -59	80	120
+3 -15	+4 -21	+12 -28	-9 -27	-8 -33	0 -40	-21 -39	-20 -45	-12 -52	-36 -61	-28 -68	120	180
+2 -18	+5 -24	+13 -33	-11 -31	-8 -37	0 -46	-25 -45	-22 -51	-14 -60	-41 -70	-33 -79	180	250
+3 -20	+5 -27	+16 -36	-13 -36	-9 -41	0 -52	-27 -50	-25 -57	-14 -66	-47 -79	-36 -88	250	315
+3 -22	+7 -29	+17 -40	-14 -39	-10 -46	0 -57	-30 -55	-26 -62	-16 -73	-51 -87	-41 -98	315	400
+2 -25	+8 -32	+18 -45	-16 -43	-10 -50	0 -63	-33 -60	-27 -67	-17 -80	-55 -95	-45 -108	400	500
-	0 -44	0 -70	-	-26 -70	-26 -96	-	-44 -88	-44 -114	-78 -122	-78 -148	500	630
-	0 -50	0 -80	-	-30 -80	-30 -110	-	-50 -100	-50 -130	-88 -138	-88 -168	630	800
-	0 -56	0 -90	-	-34 -90	-34 -124	-	-56 -112	-56 -146	-100 -156	-100 -190	800	1000
-	0 -66	0 -105	-	-40 -106	-40 -145	-	-66 -132	-66 -171	-120 -186	-120 -225	1000	1250
-	0 -78	0 -125	-	-48 -126	-48 -173	-	-78 -156	-78 -203	-140 -218	-140 -265	1250	1600
-	0 -92	0 -150	-	-58 -150	-58 -208	-	-92 -184	-92 -242	-170 -262	-170 -320	1600	2000
-	0 -110	0 -175	-	-68 -178	-68 -243	-	-110 -220	-110 -285	-195 -305	-195 -370	2000	2500

Appendix

12. IT Classes for Basic Tolerances

Nominal Dimensions : mm

Over To	1 3	3 6	6 10	10 18	18 30	30 50	50 80	80 120	120 180	180 250	250 315	315 400	400 500	500 630	630 800	800 1000	1000 1250	1250 1600	1600 2000	2000 2500	2500 3150
---------	--------	--------	---------	----------	----------	----------	----------	-----------	------------	------------	------------	------------	------------	------------	------------	-------------	--------------	--------------	--------------	--------------	--------------

Unit : μm

IT0	0.5	0.6	0.6	0.8	1	1	1.2	1.5	2	3	4	5	6								
IT1	0.8	1	1	1.2	1.5	1.5	2	2.5	3.5	4.5	6	7	8								
IT2	1.2	1.5	1.5	2	2.5	2.5	3	4	5	7	8	9	10								
IT3	2	2.5	2.5	3	4	4	5	6	8	10	12	13	15								
IT4	3	4	4	5	6	7	8	10	12	14	16	18	20								
IT5	4	5	6	8	9	11	13	15	18	20	23	25	27	29	32	36	42	50	60	70	86
IT6	6	8	9	11	13	16	19	22	25	29	32	36	40	44	50	56	66	78	92	110	135
IT7	10	12	15	18	21	25	30	35	40	46	52	57	63	70	80	90	105	125	150	175	210
IT8	14	18	22	27	33	39	46	54	63	72	81	89	97	110	125	140	165	195	230	280	330
IT9	25	30	36	43	52	62	74	87	100	115	130	140	155	175	200	230	260	310	370	440	540
IT10	40	48	58	70	84	100	120	140	160	185	210	230	250	280	320	360	420	500	600	700	860
IT11	60	75	90	110	130	160	190	220	250	290	320	360	400	440	500	560	660	780	920	1100	1350
IT12	100	120	150	180	210	250	300	350	400	460	520	570	630	700	800	900	1050	1250	1500	1750	2100

13. Physical/Mechanical Characteristics of Metals

Material	Specific Gravity	Linear Expansion Coefficient (0-100°C)	Hardness (Brinell)	Final Modulus of Elasticity(MPa) (kgf/mm ²)	Tensile Strength(MPa) (kgf/mm ²)	Yield Point (MPa) (kgf/mm ²)	Elongation (%)
Bearing Steel(Hardened)	7.83	12.5 × 10 ⁻⁶	650-740	208 000 {21 200}	1 570-1 960 {160-200}	-	-
Martensite Stainless Steel SUS 440C	7.68	10.1 × 10 ⁻⁶	580	200 000 {20 400}	1 960 {200}	1 860 {190}	-
Mild Steel (C=0.12-0.20%)	7.86	11.6 × 10 ⁻⁶	100-130	206 000 {21 000}	373-471 {38-48}	216-294 {22-30}	24-36
(C=0.12-0.20%)	7.84	11.3 × 10 ⁻⁶	160-200	206 000 {21 000}	539-686 {55-70}	333-451 {34-46}	14-26
Austenite Stainless Steel SUS 304C	8.03	16.3 × 10 ⁻⁶	150	193 000 {19 700}	588 {60}	245 {25}	60
Cast Iron Grey Cast Iron FC 20	7.3	10.4 × 10 ⁻⁶	140-200	98 100 {10 000}	167-265 {17-27}	-	-
	Spherulitic graphite cast iron FCD 20	7.0	11.7 × 10 ⁻⁶		Same or below 201	Same or below 302 {40}	-
Aluminium	2.69	23.7 × 10 ⁻⁶	15-26	70 600 {7 200}	78 {8}	34 {3.5}	35
Zinc	7.14	31 × 10 ⁻⁶	30-60	92 200 {9 400}	147 {15}	-	30-40
Copper	8.93	16.2 × 10 ⁻⁶	50	123 000 {12 500}	196 {20}	69 {7}	15-20
Brass (Hardened)	8.5	19.1 × 10 ⁻⁶	About 45	103 000 {10 500}	294-343 {30-35}	-	65-75
			85-130		363-539 {37-55}	15-50	

Hardness of both heat-treated steels and martensite stainless steels are generally denoted by using the Rockwell Scale, but in this table, for the sake of comparison, they were converted to Brinell hardness values.



Ball Bearing · Roller Bearing · Special Bearing

