

## ASC Series

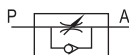

### Symbol



### Product feature

1. Small and compact structure.
2. Allows air to exhaust and cut off air flow. The adjustment screw is both sensitive and precise..
3. Can be mounted in various position to facilitate installation and application.

### Flow chart

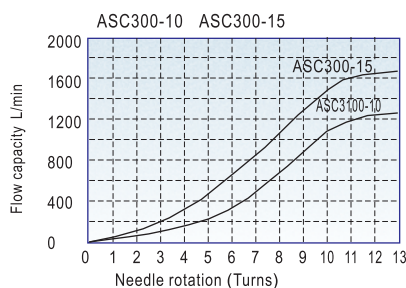
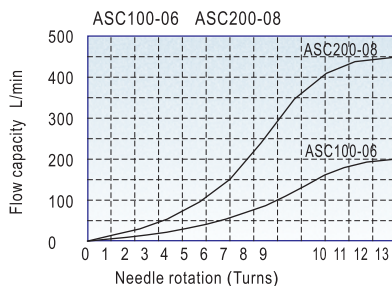

### Inner structure

No.	Item
1	Adjustment cap
2	Clamping cap
3	Throttle body
4	Hexagon nut
5	O-ring
6	O-ring
7	Throttle sheath
8	Body
9	Throttle column
10	Spool O-ring

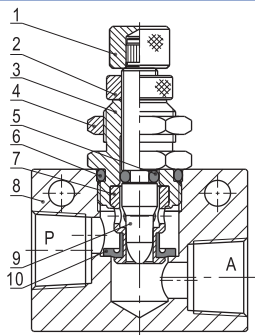

### Specification

Model	ASC100-06	ASC200-08	ASC300-10	ASC300-15	
Fluid	Air (to be filtered by 40 μm filter element)				
Port size <sup>①</sup>	1/8"	1/4"	3/8"	1/2"	
Pressure range	0.05~0.95MPa(7~135psi)				
Proof pressure	1.5MPa(215psi)				
Temperature	-20~70°C				
Material body	Aluminum alloy				
Flow (L/min)	Control flow	200	450	1250	1650
	Free flow	400	800	1500	2500

① PT thread, NPT thread and G thread are available.

### Ordering code

#### ASC 300 10

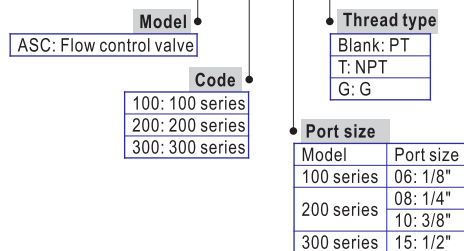

### Dimensions

#### ASC100, 200

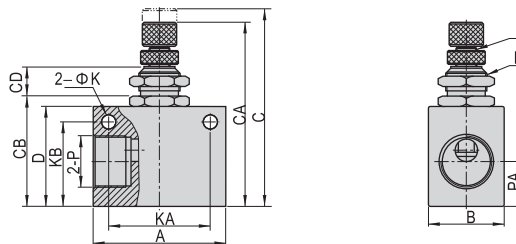

#### ASC300

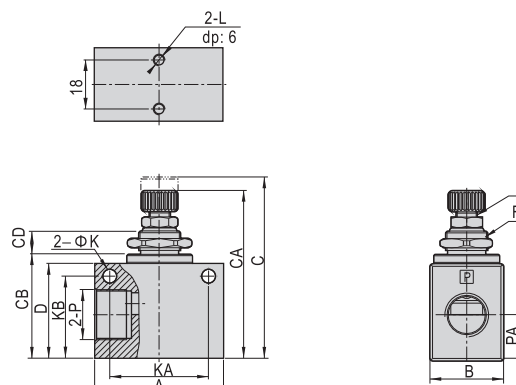

Type\Item	A	B	C	CA	CB	CD	D	E	F	K	KA	KB	L	P	PA
ASC10006	32	18	52.5	47	26	8.6	23	M6×0.5	M12×0.75	4.3	22	18	M4×0.7	1/8"	10
ASC20008	36	18	56.5	51	30	8.6	27	M6×0.5	M12×0.75	4.3	26	23	M4×0.7	1/4"	13.5
ASC30010	50	28	74	65	40.5	10	37	M8×0.75	M16×1.0	5.3	35	32	M4×0.7	3/8"	17.5
ASC30015	50	28	74	65	40.5	10	37	M8×0.75	M16×1.0	5.3	35	32	M4×0.7	1/2"	17.5

