



TFS series

Outdoor Rock Speaker

Instruction Manual



[page intentionally left blank]

Before you begin

A passive outdoor loudspeaker system is one of the best audio entertainment investment you can make for both residential and commercial installations. Investing the time and labor to install a wired speaker system will provide the safest and most dependable sound solution that can be easily upgraded and customized over time.

Before connecting the speakers, please take the time to design and review the overall system, making sure the speakers are well-situated to provide an even coverage with adequate sound level. Depending on the specific model, the speaker may or may not include a wire tail. You will likely need to purchase additional speaker wires to connect the entire sound system. The longer the distance covered, the higher gauge of speaker wires should be used to maximize audio performance.

When selecting and connecting an amplifier to a passive loudspeaker, it is important to understand the relationship and impact of impedance load and power wattage between amplifier and loudspeaker. Caution must be used to ensure impedance load of loudspeaker system is compatible with the selected amplifier's operable range, especially when loudspeakers are wired in parallel, series, or a combination of the two. Incorrect impedance matching may cause irreparable harm to your audio equipment.

When considering power of your amplifier, most audio professionals and audiophile will recommend an amplifier with an output power above the loudspeaker's power handling rating. This is the ideal set up to maximize audio performance as the extra power will ensure delivery of sufficient power during short periods of audio peaks along with fuller dynamic range and effortless loud volume output. However, the ability to deliver extra power may cause potential damage to the loudspeaker, especially when playing loudly in a sustained period. Caution and restraint must be used to ensure longevity of the loudspeaker under the ideal set up. If longevity and safe operation is more important than optimal audio performance, you should select an amplifier with a RMS power rating at or slightly below the loudspeaker's rating. Please consult a professional installer if you are unsure about impedance and power level matching.

If you need help or have further question, please contact us at www.ticcorp.com.

Wiring Diagram

Choose the appropriate wiring option depending on your model and overall system design.

Simple 8Ω installation

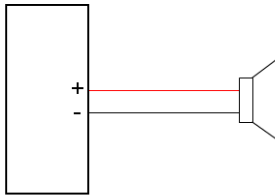

mono or bridged mode

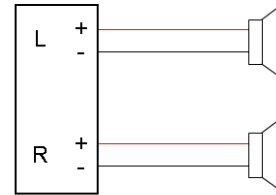

stereo mode

** Colorized version of wiring diagrams and manual is available on our website (www.ticcorp.com). In typical installations, positive terminals are connected to red wires and negative terminals are connected to black wires.*

Four 8Ω speakers 2-channel installation

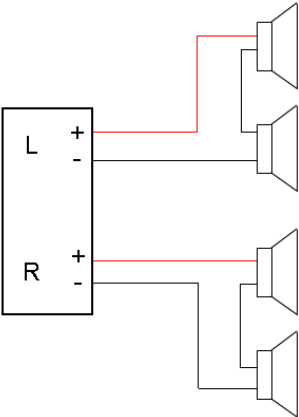

series wiring (16Ω/channel)

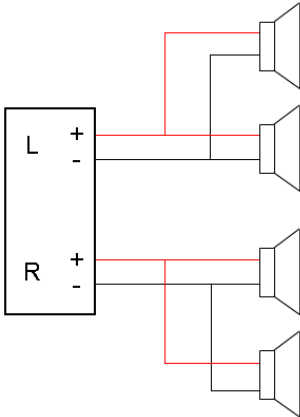

parallel wiring (4Ω/channel)

Eight 8Ω speakers 2-channel installation

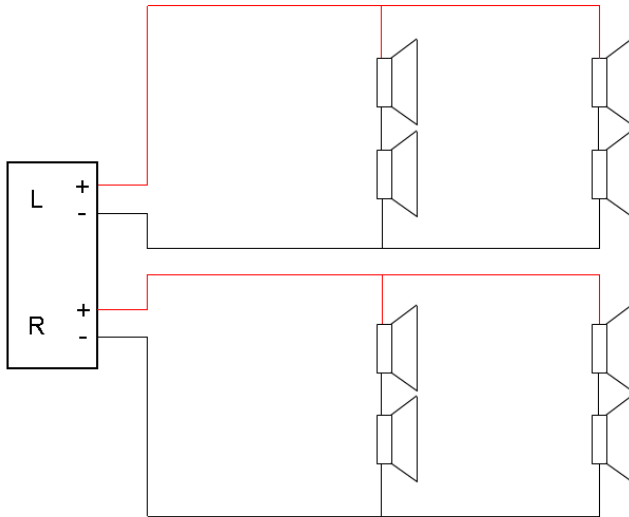

series-parallel wiring (8Ω/channel)

Dual Voice Coil (DVC) installation options

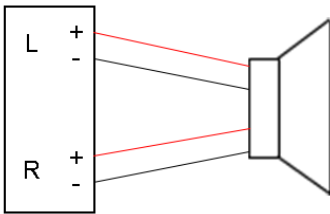

Standard stereo wiring
(8Ω /channel)

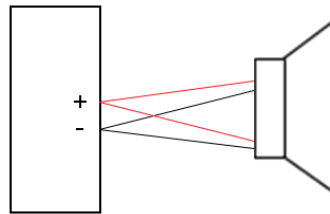

Parallel bridged/mono wiring
(4Ω)

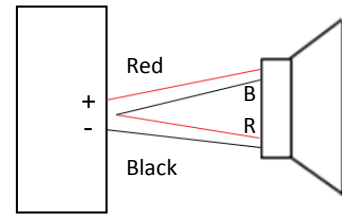

Series bridged/mono wiring
(16Ω)

Subwoofer installation

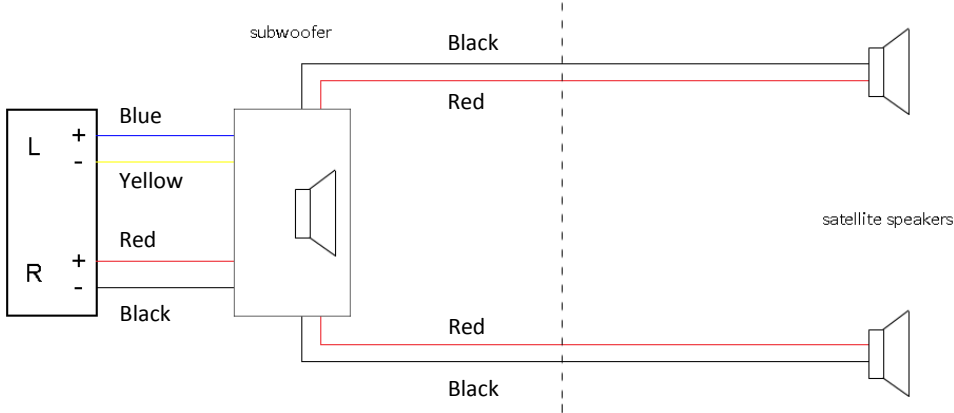

Standard wiring
(8Ω/channel)

Optional satellite wiring
(4Ω/channel)

Installation/Maintenance Note

- The TFS speaker is typically surface-mounted. Please ensure the wiring is safely secured and does not become a tripping hazard. If you desire to bury the speaker partially, please ensure the speaker grill is at least 2" above ground level.
- We recommend using burial-grade insulated speaker wires. Conduit can be used alternatively in conjunction with standard speaker wires. Wire/conduit should be buried 4-6" below ground.
- For connecting/extending speaker wires, we highly recommend using waterproof wire connector (ie. SPC-CN1). Alternately, silicon can be applied to the opening of standard wire nut to provide water protection.
- The TFS series is designed to be water-resistant not waterproof. The speaker should not be installed in a low area prone to water collection or where sprinklers will spray into the grill. During heavy snow season where snow fall level will be higher than the grill, speaker should be covered by a plastic tarp so that melted snow will be diverted away from the speaker driver. The TFS speaker is designed to be protected against rain and snow fall but not water submersion.
- System should be fully tested above surface before speakers and wires are buried.
- If sound is muddled or multiple speakers are not in sync, please check to ensure wire polarity is correct.
- To clean speaker, wipe surface with a damp cloth. If needed, use mild detergent to remove dirt. Do not spray water directly into the grill.

Specification

| | <u>TFS0</u> | <u>TFS5</u> | <u>TFS6/TFS10</u> | <u>TFS12</u> | <u>TFS14</u> | <u>TFS25</u> | <u>TFS50</u> |
|---------------------------|---------------------------|-----------------------------|-------------------------|---|---|--------------------------|--|
| Type | Pair of Coaxial | Pair of Coaxial | Single Coaxial | 3-Way DVC | 3-Way | Omni-Directional Coaxial | Omni-Directional Subwoofer |
| Driver Size | 5" woofers 1" tweeters | 6.5" woofers 2" tweeters | 8" woofer 2" tweeter | 8" woofer 2 x 2" tweeters | 10" woofer 5" midrange 2" tweeter | 8" woofer 2" tweeter | 8" subwoofer |
| Power Handling (RMS/Peak) | 40W /80W | 75W /150W | 100W /200W | 100W /200W | 150W /300W | 100W /200W | 125W /250W |
| Impedance | 8Ω | 8Ω | 8Ω | 8Ω/channel 4Ω (parallel) 16Ω (series) | 8Ω | 8Ω | 8Ω (standard) 4Ω (with satellites) |

TIC Audio Inc. All rights reserved. The TIC logo is a trademark of TIC Audio Inc, registered in the United States. Features, specifications, and appearance are subject to change without notice.

Please consult audio professionals if you have any question regarding sound system design and installation.

For more information, please visit our website: www.ticcorp.com.

TIC 