

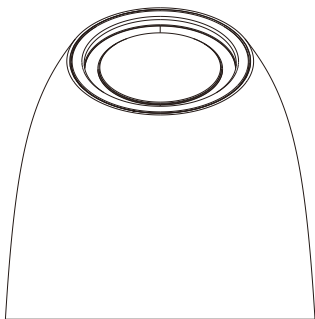

Parasol

User Manual



Parasol

Please follow the instruction
in this guide to enjoy the best sound.



Package Contents

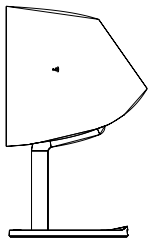

A



B



C



D



E

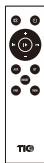

F



Operation Instruction

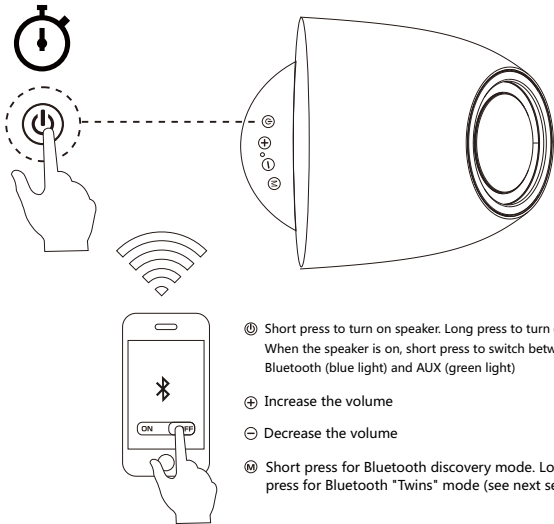



Bluetooth Twins (additional speaker required)

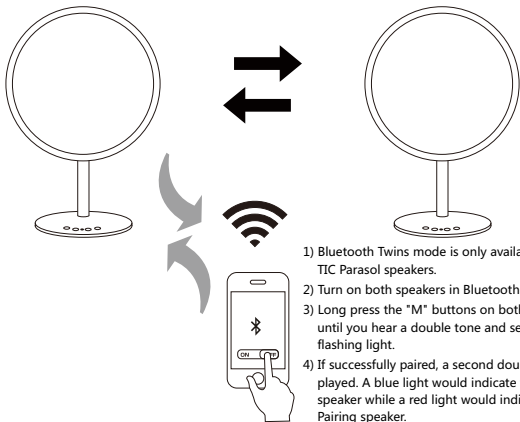

- 1) Bluetooth Twins mode is only available with two TIC Parasol speakers.
- 2) Turn on both speakers in Bluetooth mode.
- 3) Long press the "M" buttons on both speakers until you hear a double tone and see quick blue flashing light.
- 4) If successfully paired, a second double tone is played. A blue light would indicate the Main speaker while a red light would indicate the Pairing speaker.
- 5) Connect audio device to Main speaker and play music as previously instructed.

Note:

- 1) While in "Twins" mode, control will be only be available via the Main speaker (except for the power off function in the Pairing speaker).
- 2) The Main speaker will act as the left channel speaker while the Pairing speaker will act as the right channel speaker.
- 3) If powered off and back on, the two speakers should reconnect automatically. If not, please repeat the step above to set up "Twins" mode.



NFC Connection

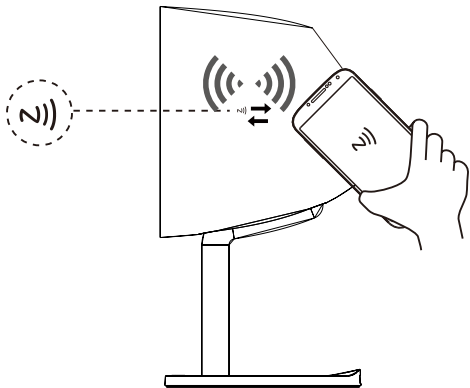

- 1) Turn on NFC on a NFC-enabled device. (Refer to device's instruction manual if unsure on how to turn on NFC.)
- 2) Put device near the NFC area and follow instruction on device when prompted for easy pairing.



Aux In Connection

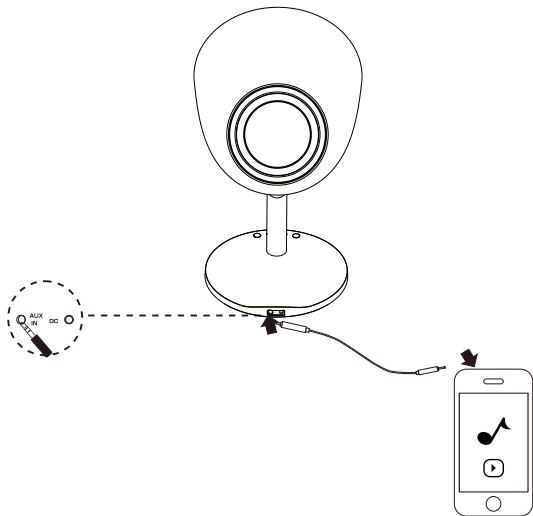



Adapter Connection

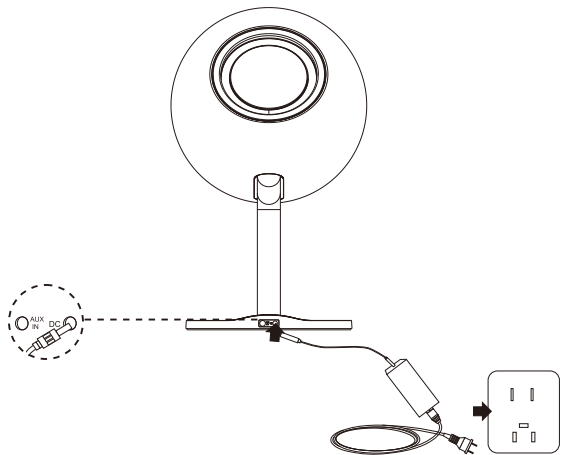



Safety and Maintenance

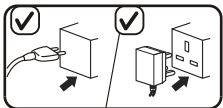
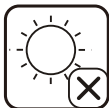
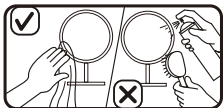



Specification



Model No.: Parasol/BA1



Product: Bluetooth Speaker



Product Size: 11.3" x 7.4" x 7.4"



Bluetooth



Output: 20W 1%THD



AUX IN 3.5MM



Power: DC 18V ==2A



NFC for easy pairing



Frequency Response: 80Hz-18KHz



Operate: Buttons, Remote Control



S/N: \cong 75db



Material: Aluminum/ Plastic



Audio Channel: 2.1



Optional stereo "Twins" mode
(additional speaker required)

IMPORTANT SAFETY INSTRUCTIONS:

- 1) Read these instructions.
- 2) Keep and follow all instructions.
- 3) Heed all warnings.
- 4) For indoor products, do not use this apparatus near water. For outdoor products, please do not expose apparatus to water longer than its intended time and level.
- 5) Clean only with a dry cloth.
- 6) Do not install this apparatus near any heat sources such as radiators, heat registers, stoves or other apparatus (including amplifiers) that produce heat.
- 7) Do not block any ventilation openings. Install this apparatus in accordance with the manufacturer's instructions.
- 8) Do not defeat the safety purpose of the polarized or grounding-type plug. A polarized plug has two blades with one wider than the other. A ground-type plug has two blades and a third grounding prong. The wide blade or the third prong is provided for your safety. If the provided plug does not fit into your outlet, consult an electrician for replacement of the obsolete outlet.
- 9) Protect the power cord from being walked on or pinched, particularly at plugs, convenience receptacles and the point where they exit from the apparatus.
- 10) Use only attachments and accessories specified by the manufacturer.
- 11) Unplug this apparatus during lightning storms or when unused for long periods of time.
- 12) Refer all servicing to qualified service personnel. Servicing is required when the apparatus has been damaged in any way, such as when the power supply cord or plug is damaged, liquid has been spilled or objects have fallen into the apparatus, or the apparatus had been exposed to rain or moisture, does not operate normally or has been dropped.
- 13) Do not expose this apparatus to dripping or splashing, and ensure that no objects filled with liquids, such as vases, are placed on the apparatus.
- 14) To disconnect this apparatus from the AC mains completely, disconnect the power supply cord plug from the AC receptacle.
- 15) The mains plug of the power supply cord shall remain readily operable.
- 16) Do not expose batteries to excessive heat such as sunshine, fire, or the like.
- 17) This is not a children's product and is not intended for use by children under 14 years old.

CAUTION:

Risk of Electric Shock. Do Not Open.



The lightning flash with an arrowhead symbol, within an equilateral triangle, is intended to

alert the user to the presence of uninsulated "dangerous voltage" within the product's enclosure that may be of sufficient magnitude to constitute a risk of electric shock to persons.



The exclamation point within an equilateral triangle is intended to alert the user to the presence of important operating and maintenance (servicing) instructions in the literature accompanying the product.

Warning: To reduce the risk of fire or electric shock, do not expose this apparatus to rain or moisture.

BATTERY WARNING:

Your device may contain an internal, rechargeable battery that is not replaceable. Improperly replaced batteries may present a risk of leak or explosion and personal injury. Mistreated rechargeable batteries may present a risk of fire or chemical burn. Do not disassemble or expose to conducting materials, moisture, liquid, or heat above 54°C (130°F). Do not use or charge battery if it appears to be leaking, discolored, deformed, or in any way abnormal. Do not leave battery discharged or unused for extended periods. Do not short circuit. Battery life varies with usage. Non-operational batteries should be discarded according to local laws. If no laws or regulations govern, dispose of your device in a waste bin for electronics. Keep batteries away from children.

SOUND WARNING:

Avoid hearing damage by establishing safe listening volumes. Listening to this product at high volumes or for extended time periods may cause permanent hearing loss. Protect your hearing by establishing safe volumes. Start with the volume setting control at its lowest setting. Slowly increase the volume until you can hear it comfortably and clearly without distortion. Reduce the volume or stop listening if you experience ringing in your ears or any discomfort. Consult with a physician if needed.

FCC Warning

This device complies with Part 15 of the FCC Rules. Operation is subject to the following two conditions

- (1) this device may not cause harmful interference, and
- (2) this device must accept any interference received, including interference that may cause undesired operation. Changes or modifications not expressly approved by the party responsible for compliance could void the user's authority to operate the equipment.

Note 1:

This equipment has been tested and found to comply with the limits for a Class B digital device, pursuant to part 15 of the FCC Rules. These limits are designed to provide reasonable protection against harmful interference in a residential installation. This equipment generates, uses and can radiate radio frequency energy and, if not installed and used in accordance with the instructions, may cause harmful interference to radio communications. However, there is no guarantee that interference will not occur in a particular installation. If this equipment does cause harmful interference to radio or television reception, which can be determined by turning the equipment off and on, the user is encouraged to try to correct the interference by one or more of the following measures:

- Reorient or relocate the receiving antenna.
- Increase the separation between the equipment and receiver.
- Connect the equipment into an outlet on a circuit different from that to which the receiver is connected.
- Consult the dealer or an experienced radio/TV technician for help.

Note 2:

- 1.Changes or modifications to this unit not expressly approved by the party responsible for compliance could void the user's authority to operate the equipment.
2. This equipment should be installed and operated with a minimum distance of 20 cm between the device and your body.

TIC Audio Inc. All rights reserved. The TIC logo is a trademark of TIC Audio Inc, registered in the United States. Features, specifications, and appearance are subject to change without notice.

For more information, please visit our website: www.ticcorp.com.