

# Owner's Manual

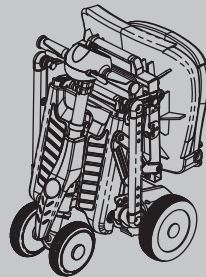

Read this manual before  
using the Scooter and  
save for future reference.

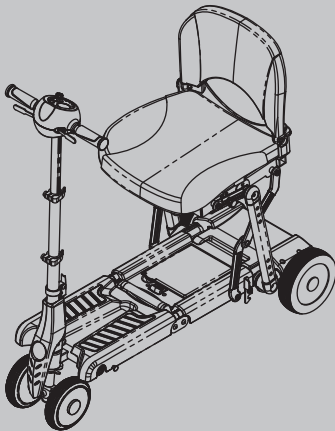





### ■ **Indications For Use**

The Merits Yoga Power Scooter, S542, is to provide mobility to adult persons limited to a sitting position and capable to operate a few simple controls.

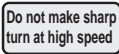
## ■ PRODUCT SAFETY SYMBOLS

The symbols below are used on the scooter to identify warnings, mandatory actions, and prohibited actions. It is very important for you to read and understand them completely.

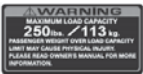
**!** **HAZARD IDENTIFICATION:** The hazard identification surround shape is represented as a yellow symbol on a black triangle with a black border. It is used to indicate a potentially hazardous condition/situation that could result in personal injury, component damage, or malfunction.

	Do not make sharp turns at high speed. It may cause the vehicle to tip over.
	Uncompleted folding procedure will cause damage or injury. The latch is locked if the folding or unfolding procedure is completed.
	Pinch/Crush points created during folding and unfolding procedure.
	Switch off the power on scooter before installing or removing the battery pack.
	Maximum weight capacity of this scooter is 250lbs (113kg)
	Indicates the battery charging port.
	The scooter is designed to work best indoors or on paved, level ground.

### **!** WARNING

For your safety, please read the owner's manual before operating this product. Before reading through the owner's manual, please do not operate the product.

### **!** WARNING

For your safety, when you operate the scooter or before you operate the scooter, if you find any problem, please stop operating the scooter immediately and contact with the dealer for solving the problem.

### **!** WARNING

For your safety, the user should be comply with the following condition for operating the scooter:

1. Spirits in good condition, can clearly distinguish the surroundings condition and physical function are normal to operate the scooter.
2. After drinking or eating of alcoholic beverages or food, do not operate the product.
3. Before operating the scooter, do not take medicine which might affect sanity or mental state.

### **!** WARNING

For your own safety, Visually Impaired person can not operate this product

# Table of Content

## Introduction

Practice before Operating .....	4
---------------------------------	---

## Safety Instructions

Safety Considerations .....	9
Driving Outdoors .....	12
Use caution when driving on hills .....	14

## Familiarize Yourself with your Scooter

The Battery .....	16
Feature Diagram .....	17
Terminology .....	18
Fold and Unfold your scooter .....	19
Install and Remove Battery Pack .....	27

## Operating your Scooter

Controls .....	30
Seat .....	32
Tiller Angle Adjustment .....	33
Care and Maintenance .....	34
Cleaning and Disinfection .....	38

## Technical Specification-S542

IEC Symbols .....	39
-------------------	----

Warranty .....	40
----------------	----

## ■ INTRODUCTION

### ■ Seat

The level of resistance to ignition of materials and assemblies ; Materials are tested according to ISO7176-16 (seat, armrests).

### ■ Electrical components

The level of resistance to ignition of materials and mains current are tested according to UL94-V0.

Note: The product meets all the requirements of ISO 7176-14:2008. Forces necessary to operate the control devices: engage should be less than 60N, disengage should be less than 60N, push buttons should be less than 1N.

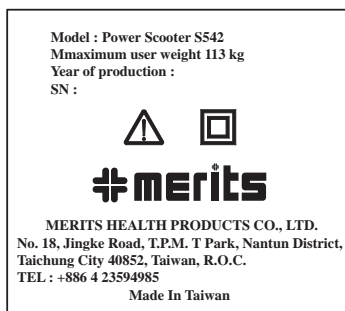

### ■ Modification

#### WARNING

Do not modify your scooter or change the programmed parameters of your scooter controller in any way. Do not use any accessories if they have not been tested or approved. These may result in personal injury and damage the scooter. Only from the manufacturer authorized personnel may perform any adjustments for you.

Do not sit on your scooter when in a vehicle, but transfer to a vehicle seat and stow the scooter in the vehicle storage space.

In any emergency of case, can use turn off the key switch to emergency stop the scooter.

## ■ Incline information

Now building have ramps with specified degree of inclination, designed for easy and safe access. Pay attention when driving down a incline and keep the scooter's speed adjustment set to the slowest speed setting to ensure a safely controlled descent. Avoid sudden stops and starts on the ramps.

### ⚠ WARNING

- When climbing an incline, try to keep your scooter moving. If you must stop, start up again slowly and accelerate cautiously. when driving down an incline, set your scooter the slowest setting and drive in the forward direction only.
- Do not zigzag or drive at an angle up the face of the incline. Drive your scooter straight up the incline. This greatly reduces the possibility of a tip or a fall. Always exercise extreme caution when negotiating an incline.
- You should not travel up or down a potentially hazardous inline, such as area covered with snow, ice, cut grass, or wet leaves.
- When on any sort of incline or decline, never place the scooter in "Free wheel" mode while seated on it or standing next to it. It may result in personal injury and damage to your scooter. Never travel down an incline backwards, it may result in personal injury.

(Picture 2.1 with driving position-Increased stability driving position)

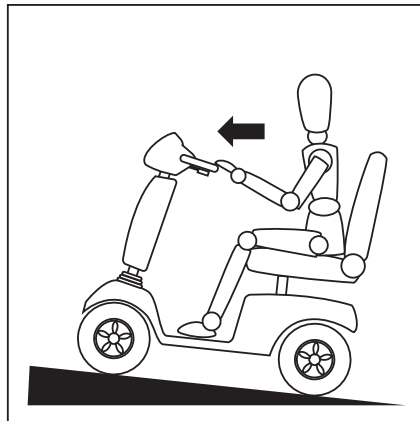

Picture 2.1 Incline information

## ■ Braking information

Your scooter is equipped with these powerful braking systems:

Electromagnetic regenerative brake: Uses electricity to rapidly slow the vehicle when the throttle control lever returns to the center/stop position and act as a parking brake.

## ■ Obstacles (steps, curbs, etc)

Do not attempt to have your scooter proceed backward down any step, curb, or other obstacle. This may cause the scooter to tip. We recommend that you do not attempt to negotiate a curb that has a height greater than 1"(25mm). With in 500mm run-up. Doing so could cause instability in your scooter.



**Picture 2.2 Obstacles information**

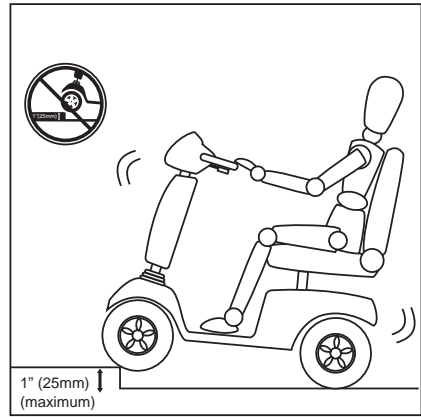

**Picture 2.3 Obstacles information**

## ■ Intended Users

The driving function of this scooter should be operated by occupant who is capable of operating the throttle lever, buttons, dial, and handle. All the other functions, such as adjustment, charging / replacing battery, folding/unfolding, transportation, and storage can be operated by occupant or assistant.

Failure to follow these instructions may result in damage to the scooter or serious injury.

## Practice Before Operating

Find an open area such as a park and have an assistant to help you practice until you have confidence operating this vehicle.

Make sure that the unit is off before getting in or out of the it. Set the speed control knob according to your driving ability.

**We recommend that you keep the speed at the slowest position (fully counter-clockwise) until you are familiar with the driving characteristics of this vehicle.**



Stop, forward, and reverse operation practice

Push the lever backward on the **right** side to move **forward**

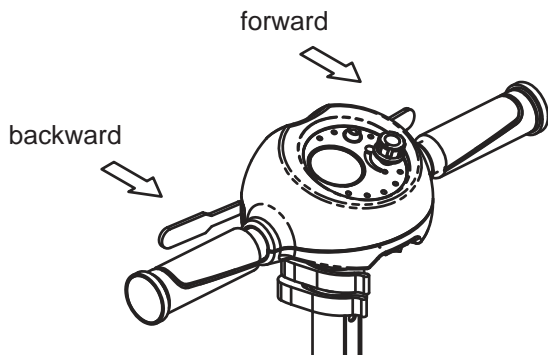

Push the lever backward on the **left** side to move **backward**



## Getting familiar with this vehicle



**First, practice moving forward.  
Be sure to set the speed to the lowest setting.**

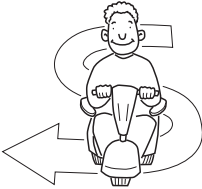

**After becoming familiar with moving forward,  
practice making "S" turns.**



**Once you are familiar with "S" turns, practice  
moving in reverse. Note that any speed control  
setting, the vehicle moves more slowly in reverse  
than forward**

## Safety Considerations

DO NOT do any of the following



**NO!**

Do not carry any passengers



**NO!**

Do not drive across a slope



**NO!**

Do not drink and drive

Consult your physician to determine if your medications impair your ability to control this vehicle



**NO!**

Do not tow a trailer



**NO!**

Do not turn on or use hand-held personal communication devices such as citizens band(CB) radios and cellular phones



**NO!**

Do not make turns at high speed. Making turns at high speed is very dangerous and may cause the vehicle to tip over.

This vehicle has an immunity level of 20 V/m which should protect it from Electromagnetic Interference(EMI) from Radio Wave Sources. The rapid development of electronics, especially in the area of communications, has saturated our environment with electromagnetic (radio) waves that are emitted by television, radio and communication signals. These EM waves are invisible and their strength increases as one approaches the source. All electrical conductors act as antennas to the EM signals and, to varying degrees, all power wheelchairs and scooters are susceptible to electromagnetic interference (EMI). This interference could result in abnormal, unintentional movement and/or erratic control of the vehicle. The United Statement be incorporated to the user's manual for all electric scooter:

Powered wheelchairs and electric scooters(in this text, both will be referred to as powered wheelchairs) may be susceptible to electomagnetic interference(EMI), which is interfering electromagnetic energy emitted from sources such as radio stations, TV stations, amateur radio (HAM) transmitters, two-way radios and cellular phones. The interference (from radio wave sources) can cause the powered wheelchair to release its brakes, move by itself or move in unintended directions. It can also permanently damage the powered wheelchair's control system. The intensity of the EM energy can be measured in volts per meter (V/m). Each powered wheelchair can resist EMI up to a certain intensity. This is called the "immunity level." The highedr the immunity level, the greater the protection. At this time, current technology is capable of providing at least 20 V/m of immunity level which would provide useful protection against common sources of radiated EMI.

Following the warnings listed below should reduce the chance of unintended brake release or powered wheelchair movement that could result in serious injury:

- 1) Do not turn on hand-held personal communication devices such as citizens band (CB) radios and cellular phones while the powered wheelchair is turned on.
- 2) Be aware of nearby transmitters such as radio or TV stations and try to avoid coming close to them.

- 3) If unintended movement or brake release occurs, turn the powered wheelchair off as soon as it is safe.
- 4) Be aware that adding accessories or components, or modifying the powered wheelchair, may make it more susceptible to interference from radio wave sources. (Note: there is no easy way to evaluate their effect on the overall immunity of the powered wheelchair).
- 5) Report all incidents of unintended movement or brake release to the powered wheelchair manufacturer, and note whether there is a radio wave source nearby.

 **WARNING**

1. The scooter might disturb the operation of devices in its environment that EMIT electromagnetic fields (e.g. alarm systems of shops, automatic doors, etc.).
2. The driving performance of the scooter maybe influenced by electromagnetic fields (e.g. those emitted by portable telephones, electricity generators or high power sources).

**TURN OFF YOUR SCOOTER AS SOON AS POSSIBLE WHEN EXPERIENCING ANY OF THE FOLLOWEING:**

1. Unintentional motions.
2. Unintended of uncontrollable direction.
3. Unexpected brake release.

The FDA has written to the manufacturers of power wheelchairs, asking them to test their new products to be sure they provide a reasonable degree of immunity against EMI. The letter says that powered wheelchair should have an immunity level of at least 20 V/m, which provide a reasonable degree of protection against the more common sources of EMI. The higher the level, the greater the protection.

## Driving Outdoors

When you are on the road, please pay attention to the following:

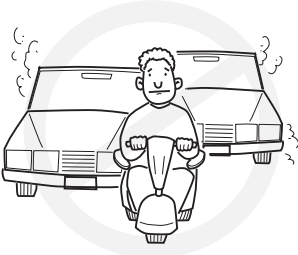

**NO!**

Do not drive in traffic.



**NO!**

Do not drive beside a river, port, or lake without a fence or railing.



**NO!**

If possible, do not drive during the rain.



**NO!**

If possible, do not drive during or on snow.



**NO!**

Do not drive off-road or on any uneven surfaced roads.



**NO!**

If possible, do not drive at night.

**NO!**

Make sure that there are no obstacles behind you when in reverse.

We recommend to set up the speed knob at the lowest speed for reversing.

**NO!**

Do not make sudden stops, weave erratically, or make sharp turns.

**NO!**

Keep your arms on or inside the armrests and feet on the footrest at all time.



1.5"(4cm)

**NO!**

Do not attempt to climb curbs greater that 1.5"(4cm).



Gap greater 3"(7.5cm)

**NO!**

Do not attempt to cross over a gap greater that 3"(7.5cm).

## Use caution when driving on hills

Driving on hills is more dangerous than on level surfaces. If you fail to heed these warnings, a fall, tip-over or loss of control may occur and cause severe injury to the vehicle user or others.



**NO!**

**Do not attempt to climb a hill greater than 6°**



**NO!**

**Do not reverse while driving up a hill.**

Forward only. If you reverse while moving up a hill, it may cause the vehicle to tip over.



**NO!**

**Do not attempt to drive across a sloping surface greater than 3°**

Driving across a slope greater than 3° is very dangerous and may cause the vehicle to tip over.



**NO!**

**Use caution when driving over soft, uneven or unprotected surfaces such as grass, gravel and decks.**

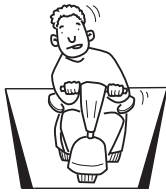
**NO!**

**Do not lean on one side while stopping on a hill.**  
Lean on one side may cause the vehicle to slide down the hill.

**NO!**

**Do not get in and off on a hill.**  
Always stop on the level surface to get in and get out of the vehicle.

**NO!**

**Do not load or carry heavy items in the basket while driving down hill.**

**YES!**

**Use low speed while driving down hill.**  
When going down hill, the tiller will become harder to reach and handle. When braking while moving down hill, the scooter will take longer to come to a complete stop.

**YES!**

**Always climb or descend gradients perpendicular to the slope or ramp.**



## Battery and Charging

### Battery Wire Connection

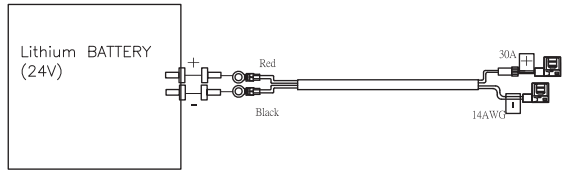

## The Battery

Your scooter is equipped with a removable battery pack, which contains one maintenance free 24v Lithium battery. This battery require no maintenance other than ensuring that it is properly charged.

### Charging the Battery

Because your battery may only has a partial charge when you first receive your scooter, you may not experience full riding time until you have fully charged it. Your scooter is equipped with an battery charger. Charging your battery as specified below will ensure maximum life, power, and range.



**WARNING : Use of a non-grounded receptacle could result in an electric shock**

### Charging Battery

1. Turn off the power on the scooter.
2. Slide away the cover of the battery receiver socket and plug the 3-pin charger power cord into the battery charging port.
3. Do not switch on the battery charger until all the plugs are in position.
4. Battery charger when starting its charge will show an amber light. The charge is complete when the charging light turns to green.



Battery charging port



### WARNING

1. Do not operate the scooter with depleted batteries since the occupant could be stranded.
2. Only use the battery pack specified and supplied by manufacturer.

## Feature Diagram

In this section, we will acquaint you with the many features of your foldable scooter and how they work. Upon receipt of your foldable scooter, inspect it for any damage. Your foldable scooter consists of the following components.



- |                                  |                            |
|----------------------------------|----------------------------|
| 1. Tiller                        | 10. Rear Shroud            |
| 2. Tiller Angle Adjustment Lever | 11. Pu Tyres (Front Wheel) |
| 3. Seat Ass'y                    | 12. Pu Tyres (Rear Wheel)  |
| 4. Anti-Tip Wheels               | 13. Locking Knob           |
| 5. Switch                        | 14. Battrey Holder         |
| 6. Wig-Wag Control Lever         | 15. Footrest Cover         |
| 7. Front Shroud                  | 16. Backup Battery Bag     |
| 8. Removable Battery Pack        | 17. Clamp                  |
| 9. Latch                         |                            |

## ■ Terminology

1. **Tiller** - Similar in operation to the handlebars of a bicycle, this device is used to steer the vehicle. It also contains the controls necessary to propel and control the vehicle.
2. **Tiller angle Adjustment Lever** - When pull, allows the tiller angle to be set for optimum driver comfort.
3. **Seat Ass'y** - Fit a single person while driving the scooter. The armrests are width and angle adjustable.
4. **Anti-tip Wheels** - Positioned one each side of the vehicle at the rear, these wheels prevent a tip-over backwards.
5. **Switch** - This is used to turn vehicle power to ON and to OFF.
6. **Wig-Wag Control Lever** - This is used to control the speed and direction of drive.
7. **Front Shroud** - This is a cosmetic cover.
8. **Removable Battery Pack** - This pack holds one 24 volt battery.
9. **Latch** - This latch holds the frame together in folding condition.
10. **Rear Shroud** - Covers the controller and the transaxle. It provides against the ingress of water and solid foreign objects.
11. **PU Tyres (Front Wheel)** - Provides the direction control for scooter.
12. **PU Tyres (Rear Wheel)** - Provides the driving power for scooter.
13. **Locking Knob** - Lock the seat in driving condition.
14. **Battery Holder** - Holds the battery pack and provides battery contacts.
15. **Footrest Cover** - User can place their feet on this cover while driving.
16. **Backup Battery Bag** - Stores backup battery to extend the driving distance.
17. **Clamp** - This is used to hold the tiller tube in position after height adjustment.

## ■ Intended Users

The driving function of this scooter should be operated by occupant who is capable of operating the throttle lever, buttons, dial, and handle. All the other functions, such as adjustment, charging / replacing battery, folding/unfolding, transportation, and storage can be operated by occupant or assistant.

## ■ Fold and Unfold your scooter

This scooter can be folded for transportation or storage. Follow the procedures below to fold and unfold your scooter and transport it with care.

### Unfold Procedures



Avoid pinch points while folding and unfolding the scooter.

### Folding Procedures

Step 1: Release the Quick Clamps on the Tiller and retract the Tiller to its lowest position.



Step 2: Pull the lever on the top of the Gas Spring which is behind the Tiller. And let the Tiller to spring back to its forefront position.

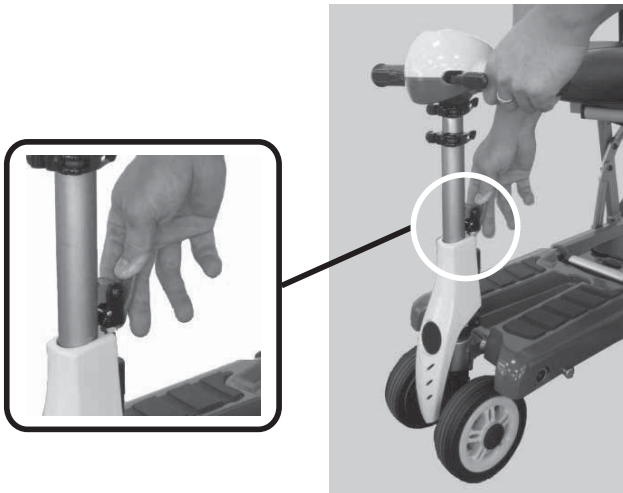

Step 3: Fold the Backrest onto the Seat and fix it with the Backrest Clip on the side of the Seat.



Step 4: Pull back the Seat Lock on the side of the Seat to unlock the Seat. Flip the Seat up and start to fold the scooter.

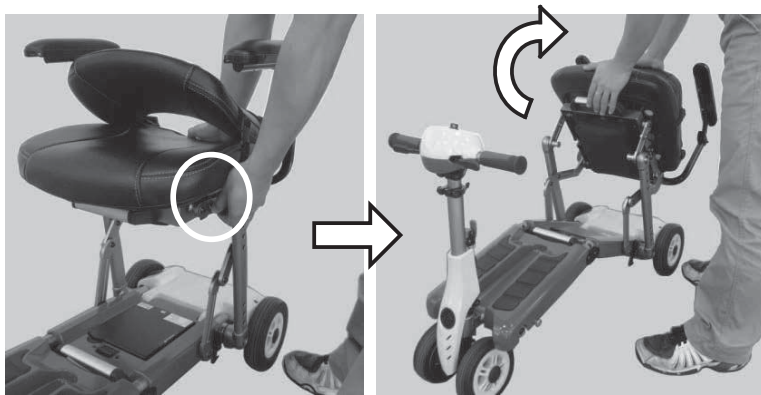

Step 5: Keep on pushing down the Seat to retract the Front Wheel and Tiller until the scooter length is almost half of its original length.



Step 6: Hold the handle under the Seat and push the footrest with one foot to let the front portion of the scooter to move toward the Seat until the rear portion is locked with the front portion.

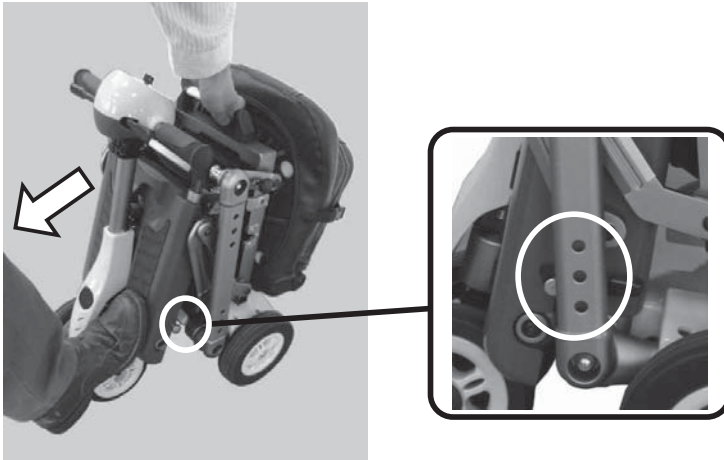

Step 7: Release the Quick Clamps on the Tiller and pull the Tiller up to an adequate position. You can either pull or push the scooter everywhere you like.



**Unfolding Procedures**

Step 1: Release the Quick Clamps on the Tiller and retract the Tiller to its lowest position.

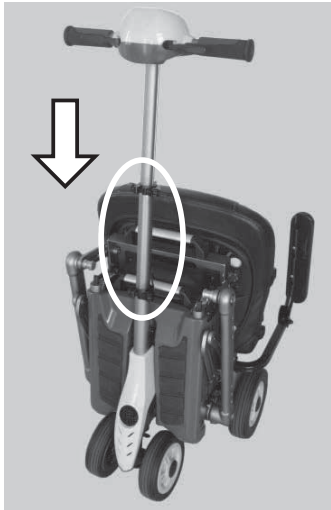

Step 2: Press down the Release Handle above the Rear Wheel to unlock the folded frame.

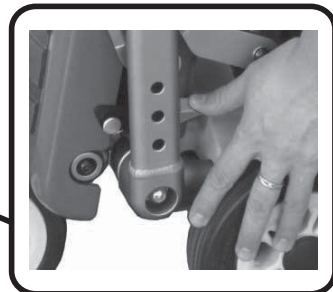



Step 3: Hold the Control Panel or Handle to push the Tiller and Front Wheel to move forward until it is hard to move it any further.



Step 4: Push down the Central Handle in the middle of the scooter with one hand and pull the lower edge of the backrest upward to rotate it to its sitting position with the other hand.

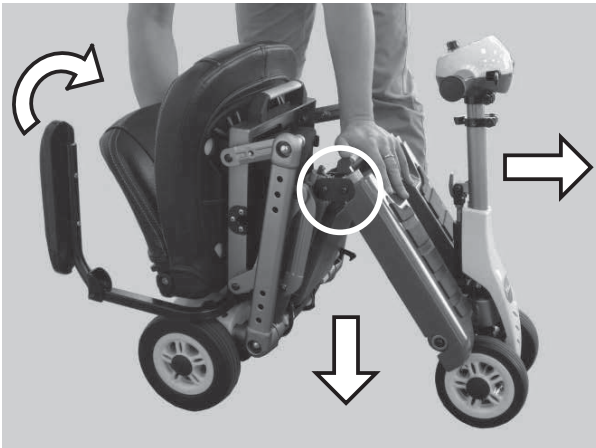

**Avoid pinch points while pushing down.**

Step 5: When the Central Handle is near to horizontal position, hold the Seat with two hands and keep on rotating it back to its normal position. A “click” sound will be heard when the Seat is locked into its normal riding position.



Step 6: Release the Backrest Clip and unfold the Backrest.



Step 7: Release the Quick Clamps on the Tiller and extend the Tiller to an adequate operating position.

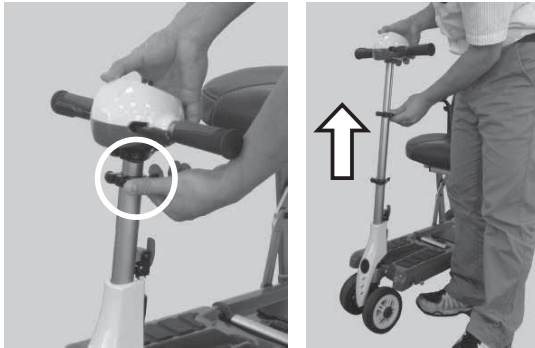

Step 8: Pull the handle on the top of the gas spring which is behind the Tiller with one hand. Hold and move the Tiller with the other hand to adjust the Tiller to a best operating angle.



### ■ Move the folded scooter

Release the quick clamps on the tiller and pull it up to an adequate position for holding the handle. Lock the clamps and then stand behind the scooter. Push the handle to move the folded scooter to the desired location.



In case of the scooter stopping in a hazardous location, e.g. the middle of a crosswalk, fold the scooter by yourself or with the assistance of others and use the folded scooter as a walker to assist you leaving this hazardous location.

## ■ Install and Remove Battery Pack

The battery pack is special designed for this scooter. Contact your dealer if you want to buy a new one for replacement.

Step 1: While removing the Battery Pack, slide and unlock the Battery Lock with your thumb.



Step 2: Pull and lift up the Battery Pack from the scooter.



Step 3: Remove the Battery Pack fully away from the Battery Recess on the scooter.

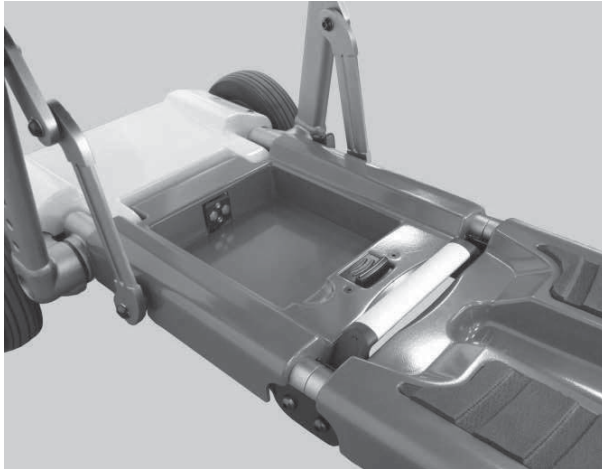

**Do not place metal objects over battery terminals.**

Step 4: While installing the Battery Pack, align the electrodes on the rear portion of the Battery Pack with the electrodes in the Battery Recess on the scooter.

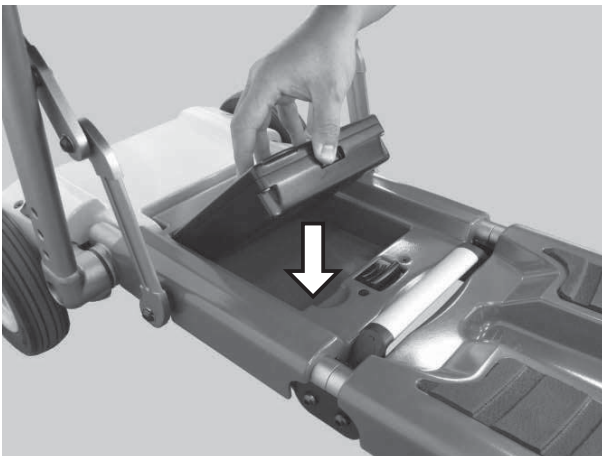

Step 5: Release the Battery Pack to let it fall into the Battery Recess on the scooter. A “click” sound will be heard when the Battery Pack is locked into position.



Step 6: Switch on the scooter to check if the battery is installed correctly.

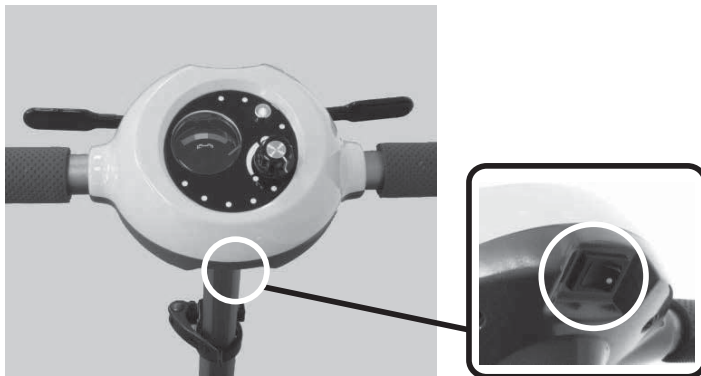

## Controls

Only drive within your control limitations. Loss of control of your scooter could result in serious injury to yourself or others. If your speed becomes difficult to control, release the speed engager lever and your scooter will come to a complete stop. Only use the on/off switch to stop your scooter in an emergency.

<p><b>Power Switch:</b> Switch <b>ON</b> to power up your scooter. Switch <b>OFF</b> to power down your scooter. I : ON O : OFF</p>	
<p><b>Speed Control:</b> Speed Dial regulates the speed of the scooter. Start at the slowest speed until you feel confident controlling your scooter safely. Turn the speed dial counter-clockwise to decrease the speed. Turn the speed dial clockwise to increase the speed.</p>	
<p><b>Forward / Reverse:</b> To move forward push the lever on the right side. To move backwards push the lever on the left side.</p>	
<p><b>Battery Gauge:</b> Indicates the charge level of the batteries. If the needle goes into the red area, the batteries need to be charged as soon as possible. If the needle is all the way to the right side of the green area, the batteries are fully charge. As the needle moves to the red area it indicates the depletion level.</p>	

## Power eye:

When the scooter is on, and all conditions are normal, the Power Eye will be on. When there is some special situation that needs attention, the light will flash. See the reference chart below for the meanings of the different flashing patterns.

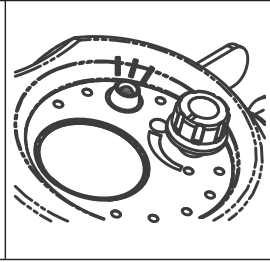

Number of Flashes	Meaning	Number of Flashes	Meaning
1	Battery needs recharging	6	Not in neutral at power up
2	Battery voltage too low	7	Speed pot error
3	Battery voltage too high	8	Motor volts error
4	Current limit time out	9	Other internal error
5	Brake fault	10	Controller over heat(C40 only)

**Brakes and Throttle control lever:** Whenever the speed engager lever is moved out of the neutral position, the electromagnetic brake will automatically release and your scooter will move. When the speed engager lever is released, it will return to the neutral position and the scooter will decelerate and come to a complete stop. The parking brake will then engage preventing further movement of your scooter. Your unit is equipped with a programmable controller that has a high peddle disable safety feature. This will prevent unexpected acceleration of the scooter, if the speed engage lever is activated the same time you turn the key "ON". To reset the controller, release the speed engage lever and turn the key "OFF" for a couple of seconds and then turn it back "ON".



**If your scooter ever moves in an unexpected manner, release the speed engager lever and turn off the power.**



## ■ Seat

### Backrest angle :

Backrest folds forward for ease of folding / storage.

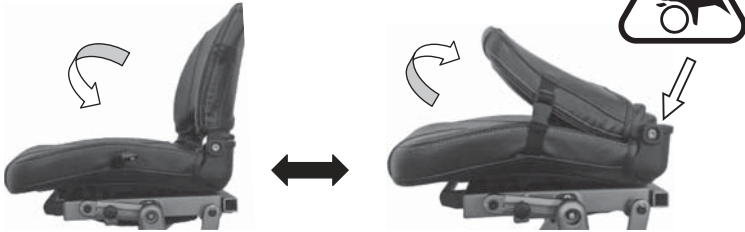

### Armrest angle:

Flip the armrest up to expose the adjustable bolt .

Turn the bolt in to lower the angle of the armrest to your desire angle.



### Armrest width:

Locate the width socket set screw

(follow the armrest support down to the base of the seat).

Loosen the socket set screw by turning counter-clockwise.

Pull the armrest in or out to reach your desired position.

Tighten the width socket set screw.

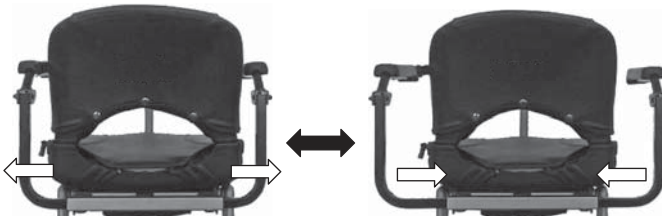

**Tiller Angle Adjustment:**

The tiller angle adjustment lever allows you to position the tiller closer or further away for better access to the controls.

Sit on the seat before adjust the tiller angle.

Hold top of the tiller with one hand and pull down the lever with the other hand.

Adjust the angle of the tiller to a comfortable position.

Release the lever, test the tiller is set in position by attempting to push back and fore to push backward and forward.



**Do not stand in front of the tiller while pulling the lever on the top of the gas spring. The tiller might hit your body while springing back.**

**Freewheel Mode:**

Whenever you need or want to push your scooter for short distance, you can fold it and put it in freewheel mode. Please refer to “Fold and Unfold your scooter” section for detail.

**Getting in and out:**

Your scooter is designed to make getting in and out of the scooter as easy as possible. Make sure the scooter is on a level surface and the key switch is turned OFF. If necessary, raise the armrest to give you maximum space to transfer in or out of the seat. Once transfer is complete, return the armrest before operating the scooter.



**Never operate your scooter without your feet being placed on the scooter platform. Driving your scooter without your feet on the platform could cause serious bodily injury.**

## Care and Maintenance

Your scooter required a minimal amount of care and maintenance. If you do not feel confident in your ability to perform the maintenance listed below, you may schedule inspection and maintenance at your authorized dealer.

Care by owner	Frequency
Cleaning and disinfection	As required
Visually check and functional check	Before use
Maintenance by authorized dealer	Frequency
Periodic check	Every year
Wheel replacement	As required
Lubricate the unit	As required

### Cleaning and Disinfection:

- Use a damp cloth and mild, non-abrasive cleanser to clean the plastic and metal parts of your scooter. Avoid using products that may scratch the surface of your scooter.
- If necessary, clean your product with an approved disinfectant. Make sure the disinfectant is safe for use on your product before application.
- Follow all safety instructions for the proper use of the disinfectant and cleaning agent before applying it to your product. Failure to comply may result in skin irritation or premature deterioration of upholstery and/or scooter finish.

(NOTE): Use "Feature Diagram" (P17) to identify the parts of your scooter.

### Check before use:

It is important for safety that you carry out the following checks before use.

1. Visually check the machine for damage.
2. Visually check the wheel for damage.
3. Check the steering moves freely.
4. Check that the tiller is secure and that the angle adjustment function is.
5. Check that the seat is locked after unfolding.
6. Check the armrests are secure
7. The batteries (including the backup battery) should be fully charged.
8. Check the operation folding/unfolding.



**Always bring a fully charged backup battery pack with you. Replace the depleted battery pack with the backup one to prevent being stuck on the road.**

### ABS plastic shrouds

- The front tiller shroud, rear shroud, and panel shroud are formed from durable ABS plastic and are coated with an advanced formula urethane paint.
- A light application of car wax will help the shrouds retain their high gloss.

### Battery Pack Contacts

- Make certain that the contacts on the battery pack remain tight and uncorroded.
- The battery pack must sit flat in the battery holder.

### Periodic check:

It is recommended that your vehicle is serviced at least once a year, by an authorized dealer. If the vehicle is used constantly we recommend a twice yearly maintenance. Report any concerns you have. See points to look out for below

- Are there any strange noises from the wheels or does the frame creak when going over rough ground?
- Is the battery charged up correctly – is the “full” charge green light on after charging?
- Is the steering tight or is it loose when turning? Is there any play in the steering?
- Has anything come loose?
- Does the vehicle perform as well as it did when it was new?
- Are there noises or rattles that were not there before?
- Are there any signs of damage, corrosion or cracking?

### Wheel replacement

Your scooter is equipped with a solid tire insert, the entire wheel must be replaced for wear.

Be sure that the power switch is turned off before performing this procedure.

Follow these easy steps for a quick and safe repair for solid tires:

1. Switch off the power switch.
2. Elevate the side of the scooter of which you are removing the wheel. Place wooden blocks under the frame to elevate the scooter.
3. Remove the cap, nut, and washer from the axle.
4. Pull the wheel off the axle.
5. Slide the new wheel back onto the axle. Make sure that the axle key is in the axle slot. Failure to ensure that the axle key is properly installed into the axle slot when mounting the wheel can result in electronic brake failure, personal injury, and product damage.
6. Reinstall the washer and nut onto the axle and tighten. Make sure both the nut and washer are installed and tightened properly. Insert the cap onto the wheel.
7. Remove the block from beneath the scooter.

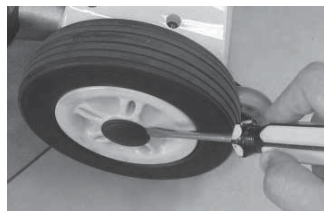

## Wiring harnesses

- Regularly check all wiring connections.
- Regularly check all wiring insulation, including the charger power cord, for wear or damage.
- Have your authorized dealer repair or replace any damaged connector, connection, or insulation that you find before using your scooter again.
- Even though the scooter has passed the necessary testing requirements for ingress of liquids, you should keep electrical connections away from sources of dampness, including direct exposure to water or bodily fluids and incontinence. Check electrical components frequently for signs of corrosion and replace as necessary.

## Nylon lock nut replacement

Any nylon insert lock nut removed during the periodic maintenance, assembly or disassembly of the scooter must be replaced with a new nut. Nylon insert lock nuts should not be reused as it may cause damage to the nylon insert, resulting in a less secure fit. Replacement nylon insert lock nuts are available at local hardware stores or through your dealer.

## Console, charger, and electronic controller module

- Keep these areas away from moisture.
- Before operating your scooter, allow any of these areas to dry thoroughly if they have been exposed to moisture.

## Fuses

To replace a fuse:

1. Switch off the power switch.
2. Remove the rear shroud.
3. Open the fuser holder and remove. Insert a new fuse of the proper rating.

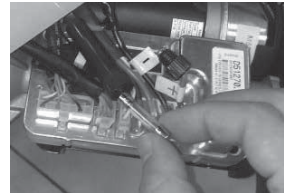
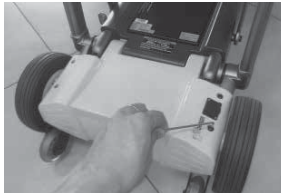

## Storing your scooter

If you plan on not using your scooter for an extended period of time, it is best to:

1. Fully charge its battery pack prior to store.
2. Remove the battery pack from the scooter.
3. Store your scooter in a warm, dry environment.
4. Avoid storing your scooter where it will be exposed to temperature extremes. Always protect battery from freezing temperatures and never charge a frozen battery. Charging a frozen battery can result in damage to the battery.

## Transport

Do not remain seated in your scooter while traveling in a motor vehicle. The scooter should be stowed in the trunk of a car with batteries removed and properly secured. All scooter parts should be removed and properly secured during motor vehicle transport.

## Recycle

According to local government information on the recycling of used batteries and other parts of scooter; use only special recycling for the scooter parts, no general disposal (e.g. batteries, electronics)

Recommended storage and shipping temperature:

Dry(15%~95% Non-Condensing), Well-ventilated area -20°C~60°C(-4°F~140°F)

Without batteries.

## Spare Parts

For spare parts replacement, please contact your dealer, or the service contact information on the back cover of this manual.

Position belt is an optional kit. For installing the position belt, please kindly contact with the dealer.

## ■ Disassembly and Assembly of the Scooter

You can disassemble the scooter into three components: the main frame, the battery pack, and the armrests. No tools are required to disassemble or assemble your scooter. Always disassemble or assemble your scooter on a level, dry surface with sufficient room for you to work and move around your scooter. Remember to turn off the power before disassemble or assemble the scooter.



**Do not lift beyond our physical capability. Ask for assistance when necessary while disassembling and assembling your scooter.**

### Battery Pack

To remove the battery pack, see “Install and Remove Battery Pack”.(P27)

For new battery or battery replacement, please contact your dealer, or the service contact information on the back cover of this manual.

### Armrests

To remove the armrests, see “Armrest width”.(P32)

### WARNING

If components of the surface of the product (such as car cover, seat, armrest, joystick handles, etc.) exposure to the sun, this may causing high temperature on the part surface,the high temperatures may cause dangers. Please use the scooter after the tact, when the surface is cool down.

## ■ Technical Specification - S542

Model No	S542
Overall Length	990 mm (38.6")
Overall Width	530 mm (20.9")
Maximum Rider Weight	114 kg (250 lbs)
Batteries	24V / 11.5AH
Battery Pack Weight	1.7 kg (3.7 lbs)
Ground Clearance	140 mm (5.5")
Total Weight(w/o battery)	24 kg (52.8 lbs)
Maximum Range Up To	18 km (11.25 miles)
Maximum Speed	6 kph (4 mph)
Front Wheel Size	6" PU Tire
Rear Wheel Size	7" PU Tire

**Note:**

- The range might be different when driving uphill or on uneven road.
- This product can be used for temperature -25°C~50°C on the hard ground environment.





### Disclosure information (ISO 7176-15:1996)

	min.	max.		min.	max.
Overall length with legrest	--	990 mm	Seat plane angle	0°	--
Overall width	--	530 mm	Effective seat depth	--	315 mm
Folded length	513 mm	--	Effective seat width	--	360 mm
Folded height	615 mm	--	Seat surface height at front edge	--	585 mm
Total mass	--	24 kg	Backrest angle	--	11°
Mass of the heaviest part	--	1.7 kg Battery	Backrest height	--	310 mm
			Footrest to seat distance	--	395 mm
Static stability downhill	--	6°	Leg to seat angle	--	--
Static stability uphill	--	6°	Armrest to seat distance	--	205 mm
Static stability sideways	--	6°	Front location of armrest structure	--	--
Energy consumption	18 km	--			
Dynamic stability uphill	--	3°	Handrim diameter	--	--
Obstacle climbing	--	25 mm	Horizontal location of axle	--	60 mm
Maximum speed forward	--	6 km/h	Minimum turning radius	1105 mm	--
Minimum horizontal braking distance from max speed	1.0 m	--	Minimum turn-around Width	1270 mm	--

### WARNING

The brake distance at the slope might be longer than the minimum brake distance under Mas speed.

### IEC SYMBOLS

	Caution, attention or consult accompanying documents.
	Alternating Current
	Double Insulation
	No Smoking or Naked Flames

Degree of protection against ingress of water is rated as IPx4.



## Warranty

Corporation warrants to the original purchaser of this wheelchair product that it is free of defect in material and workmanship and that, when operated within the guidelines and restrictions of this manual, will remain so free of defect in material and workmanship for a period of One (1) year from the original date of purchase.

Excluded from this warranty is failure due to negligence, abuse, accident, operation outside of rated limits, commercial or institutional use, damage / wear to upholstery or tires and improper maintenance or storage. The batteries for this wheelchair product are not supplied by Corporation; contact the battery manufacturer / supplier if warranty replacement is requested.

This wheelchair product must not be modified in any way without the express written consent of Corporation. Any such unauthorized modification could cause unreliable and / or unsafe operation and will void this warranty.

Where a failure occurs within the 1- year warranty period that is not excluded above, the failed components will be replaced with similar new or reconditioned components at sole option. Corporation will not be responsible for labor and / or shipping charges.

The foregoing warranty is exclusive and in lieu of all other warranties expressed or implied including, but not limited to, the implied warranty of merchantability and fitness for a particular purpose. Corporation will not be liable for any consequential or incidental damages whatsoever.

Note: Frame warranty is 2 years.



**Warranty Registration**

**WARRANTY REGISTRATION**

MODEL NO. \_\_\_\_\_

SERIAL NO. \_\_\_\_\_

DATE PURCHASED \_\_\_\_\_

NAME \_\_\_\_\_

ADDRESS \_\_\_\_\_

CITY \_\_\_\_\_ STATE \_\_\_\_\_ ZIP \_\_\_\_\_

DEALER NAME \_\_\_\_\_

STAMP

RETURN ADDRESS

\_\_\_\_\_  
\_\_\_\_\_  
\_\_\_\_\_







We wish you a safe and comfortable riding experience!



*With you for life*



**MERITS HEALTH PRODUCTS, INC.**

[www.meritsusa.com](http://www.meritsusa.com) 730 N.E. 19th Place, Cape Coral, FL 33909  
TEL:1-800-963-7487, 1-239-772-0579 FAX:1-239-574-2661