



**Customer Service:** Green Bike – Electric Motion. Main Office:  
7057 Reseda Blvd, Reseda CA 91335

Phone: (818) 578-3665 Email: [office@GreenBikeElectric.com](mailto:office@GreenBikeElectric.com)

Website: [GreenBikeElectric.com](http://GreenBikeElectric.com)

Folding Electric Bicycles MODEL HF 201– 48N

***Legend H3***

**Instruction Manual**

# **Instruction Manual**

**Green Bike – Electric Motion** Congratulations on you're newly purchased!

Joining **Greenbike's Go Green** revolution will open your doors to a whole new world of freedom! **Green Bike – Electric Motion** greatly values the quality of our products, giving you value for your money, friendly and professional service, and safety for the rider above all else.

Please uphold the product-customer-importer relationship to ensure a quality experience over time. In this manual, you will find all the details required to maintain product care.

To ensure safety during riding and to maintain long-term usage experience, please read all instructions carefully before using the bike, and follow the specified maintenance and usage instructions.

Thank you for choosing **Green Bike – Electric Motion** !

Approved by the European Standards Institute and the Israeli Ministry of Transport

T.U.V. RHAINLAND – EN15194. This electric bike is suitable to European standards as well as American Standards (CPSC - 16CFR1512) and is intended for urban cycling.

### Bicycle parts and their location:



1. Brake Handles 2. Grips 3. Handlebars 4. Adjustable Stands 5. Display 6. Gear Shifter 7. Front Brake Cable 8. Rear Brake Cable 9. Cable selector 10. Headlight and horn 11. Front mud-guard 12. Tire and inner tube 13. Front Wheel. 14. Frame 15. Front fork 16. Front wheel chain (crank) 17. Chain shield 18. Electric pedaling unit 19. Shock absorber for seat. 20. Seat clamp. 21. Lithium Ion batteries. 22. Motor Controller .23 Pedal. 25. Rear rack 26. Rear light 27. Rear brake. 28. Rear Mudguard. 29. Rear Derailleur 30. Mechanism protection 31. Gears 32. Motor 33. Seat

- Do not allow an additional rider on the bike. This bike is designed to carry one person only.

Any damage to the bicycle resulting from an additional rider is **not covered under warranty**

- The height of the seat and handlebars should be adjusted for maximum comfort and control

- The seat post and handlebars have a safety strip. Be sure it is not visible when adjusting. If the strip is not set correctly, excess pressure will be created and damage the cables.



- Be sure that the locking hinges of the seat and handlebars are locked before starting the trip.
- Check the condition of the brakes frequently and adjust when necessary. Braking range on a dry road is 13 feet and on a wet road can reach 50 feet. Keep more distance on a wet road.
- The chain is properly adjusted and should not be altered. The chain must be lubricated to prevent accelerated weathering.
- At night, the headlight and backlight must be switched on by a switch on the control display.
- Be sure to wear appropriate clothing and do not carry objects or bags in a way that they can be caught in the wheels or chain. To keep the rider safe - do not bring your legs together (too close to the chain) more than necessary.
- Do not ride in weather that does not allow safe riding such as rain, puddles, strong winds, snow, etc.
- When stopping, use both brakes. Do not be content with one brake. Use both brakes together in order to maintain stability and achieve greater control.
- Do not ride under the influence of alcohol, drugs or substances that affect the rider's alertness.
- When riding, you must hold both handles, do not perform stunts and reckless turns without examining the area from all sides before proceeding.
- Please follow local and state regulations.
- Do not drop the bike on the ground (due to the sensitivity of the battery, motor and controller). The bike should be placed on the kickstand carefully.
- Do not jump or climb sidewalks on the road.

- Damage to either the spokes, wheel, or tires resulting from typical cycling injuries and accelerated wear of the battery which may result from travel with a curved wheel are not covered by the warranty.

### Folding the Bike

- The bike can be folded for storage at home or in the trunk of the car.
- The folding time is only 10 seconds. You can get a demonstration at the point of purchase or watch a tutorial video on our site [GreenBikeElectric.com](http://GreenBikeElectric.com)

**Here are the pictures of the bike in a folded position and in an average car trunk:**

**Bicycle parts and their location:**



## Before You Start to Ride

Raise the seat as shown in Figure 3 and insert the battery into place and lock it.

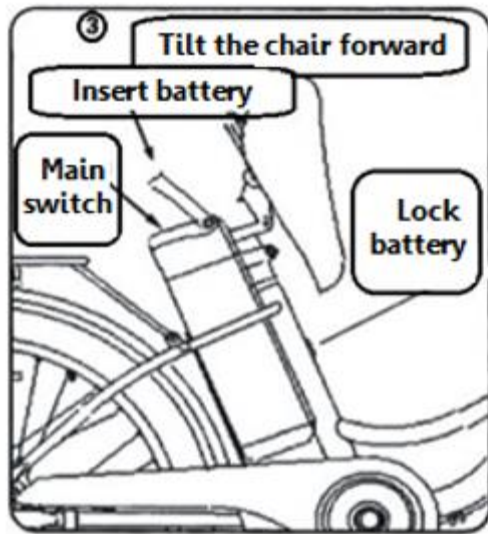

Picture 3

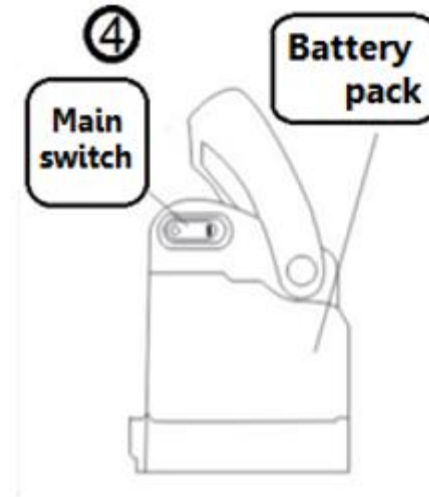

Picture 4

## KH-DX-M1 : Ebike Display with thumb throttle



### Material

Caser and Cover: ABS

LCD window: PMMA

### Overview



#### 1. Manipulation:

Integrated with one thumb throttle for speed regulation Equipped with 3 press buttons to switch display content and make parameter settings

#### 2. Protocol:

This display uses UART protocol, throttle signal is sent by UART to controller

#### 3. Speed :

Real-time SPEED, MAX SPEED, Average SPEED

#### 4. Battery level:

Indicates the battery level in real time

#### 5. Light control:

**ON/OFF** : Press  button for 3 seconds to switch on/off

#### 6. Assist level:

From 1 to 3, press up or down button to change assist level (could be set to more levels)

#### 7. Distance:

ODO/Trip/Ride time

#### 8. Error code:

Please refer to appendix table 1 for definition

#### 9. 6km/h mode:

In this mode, it will display on the screen.

#### 10. Parameters setting:



Set parameters, such as: wheel size, speed limit etc.

### Presentation of screen

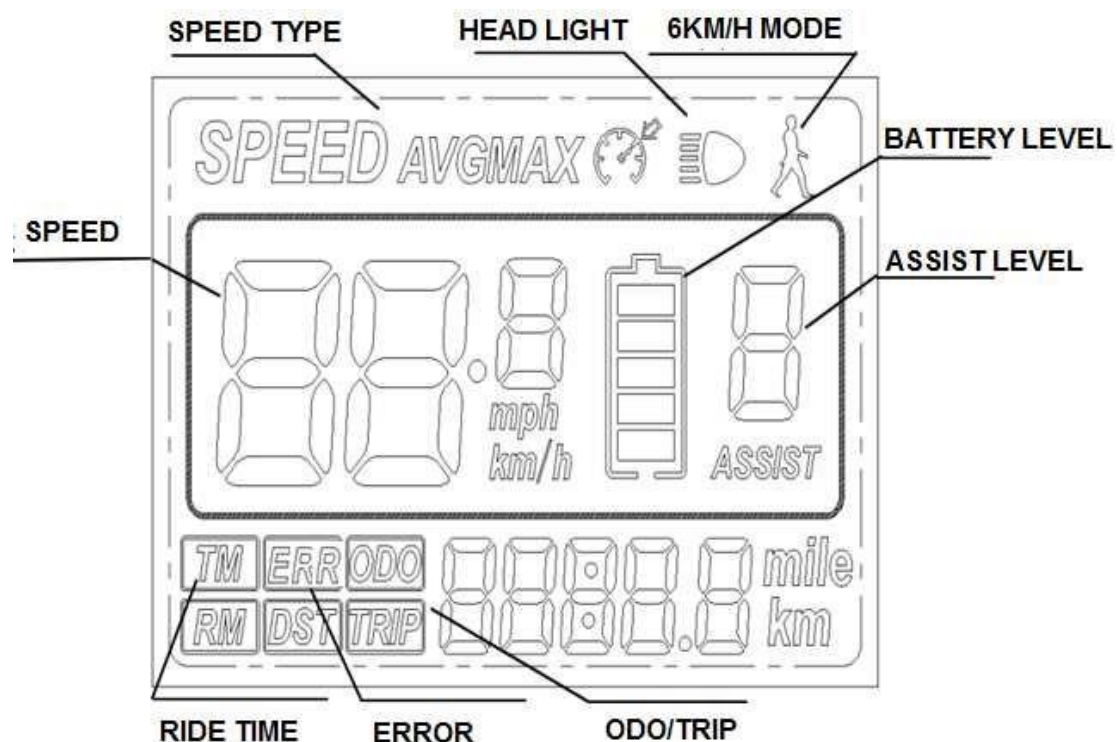



**Battery level:** 5 levels,

**Speed:** Average SPEED/MAX SPEED/Real-time SPEED

**Speed unit:** KMH/MPH

**6km/h walk mode:**



**Assist level:** assist level 1~3.

**Head light icon:** shows up when head light and back light are on.

**Distance:** Trip/ODO.

**Error code:** “ERR” and code show up when there is error.

## Operation instructions

It is equipped with 3 press buttons:





### 1. Power ON/OFF

When the power is off, Long press  ( Power ) during 3 Seconds, screen will display all contents and start to normal

working mode. When the power is on, Long press  ( Power ) during 3 seconds, screen will be powered off. If no any operation both on bike and display during 10 minutes (time could be set), the display will turn off automatically, in this case, no power consumption for both display and controller.

## 2. Different Speed display:

Long press  and  Power switch different speed information, Real time speed (SPEED) → Max speed ( MAX SPEED) → Average speed (AVG SPEED)

Real time speed



Average Speed



Max Speed



### 3. ODO/TRIP/ Ride time/Error Code

Short press  to switch ODO/TRIP/Ride time/Error Code Trip (Single trip distance)→ODO (Accumulated distance)→TM (Ride time)→ERR (Error Code)



Ride time



Error code





ODO



Trip

### 4. Assist level

Short press  or  to change assist level, default value is level 1





## 5. Light control

Long press  for 3 seconds turn on/off the head light and rear lamp









## 6. 6km/h mode

When the bike is stopped, long press , will enter 6km/h mode, the speed will be 4.5~7.5km/h according to different road conditions,  will show up on screen, long press  again or short press to quit 6km/h mode. Long press or short press could be customized by clients.





## Parameters setting

When the display is powered on, long press  and , will enter parameter setting mode, in this mode, user can change parameter values. long press again  and  will quit parameter setting mode or no operation during 10s will also quit this mode.

In parameter setting mode, short press  /  will change parameter value, short press  will save current value **and switch to next parameter.**

- **P01-back light lightness:**

short press  /  will switch from 1 to 3, Level 3 is lightest. Level 2 is default value





Picture 14

- **P02-KMH / MPH:**

Short press  /  to Switch Km/MPH.





- **P03-Battery rated voltage:**

Short press  /  to switch 24V, 36V,48V, Default value is 36V.



- **P04-Auto shutdown time:**

short press  /  to switch from 0 to 60, it is the time (in minutes) to shut down the screen automatically if no operation, 0 means never shut down, Default value is 10 minutes



- **P05-Number of Assist levels:**

Short press  /  to change level 0->1->2.

assist levels :

**0:** 3 assist levels



**1:** 5 assist levels

**2:** 9 assist levels



**P05=1 means 5 assist levels in total**

- **P06-Wheel size selection:**

short press  /  to switch wheel size, in inch, step: 0.1 inch





- **P07-Number of magnets for speed sensor:**

short press  /  to switch from 1 to 100.



Number of magnets for speed measure

- **P08-speed limit:**

short press  /  to set the speed limit from 0 to 100Km/h, 100 means no limit. In this e-bikes the controller is limited to 20 mph with throttle because the USA regulations.



Speed limit in km/h

- **P09-Non-zero speed start:**

short press  /  to switch from 0 to 1.

0: zero speed start, (you can use the electric assist start from 0 mph.)

1: non-zero speed start.

**Importer recommendation** : In order to extend the battery life time, it is recommended to start the trip with a mechanical pedal and then switch to the electric assist and not to start from 0



Start mode



- **P10-Driving mode selection:**

short press  /  to switch from 0->1->2.

0: Assist mode (throttle does not work, only pedal assist);

1: Electrical driving mode(only throttle works, pedal assist does not work)

2: Both assist and Electrical driving mode (Not available if in zero speed start and electrical driving mode)



- **P11-assist sensitivity setting:**

short press  /  to switch from 1 to 24.

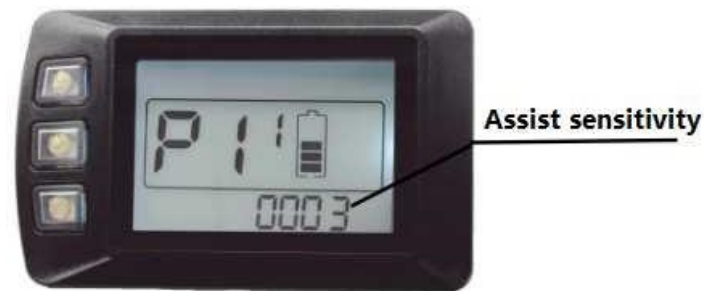



- **P12-assist starting power setting:**

short press  /  to switch from 0 to 5.



- **P13-Assist magnetic disc types:**

short press  /  to switch from 5->8->12 , different numbers of magnets in the disc.



- **P15-low voltage protection for controller :**



Low voltage protection  
for controller

- **P16-Reset ODO distance:**

long press  during 5 seconds.



Cleared to Zero



ODO reset to zero

- **P18-Reset all parameters:**

long press  5 seconds, when it displays "SSSS", all parameters reset to default values (except for the ODO distance).



"SSSS" means reset

## Specifications

Power supply: 24V,36V, 48V

Rated current: 10mA

Max current: 30mA

Leakage current after power off: <1uA

Current supply to controller: 50mA

Working Temperature: -18~65°C

Storage temperature: -30~80°C

## Notices

Power on and power off must keep an interval of at least 3 seconds,



Please don't press "  " button frequently when it is powered off. When the temperature is under -10°C, the screen will be a little darker than normal, when the temperature increases, the screen can go back to normal

## Warranty

1 year of warranty for quality issue except outside case is broken.

Table 1- Error code definition

When an error appears, display will notice users by different codes, please refer to table 1 for different codes :

Code(Decimal)	Signification	
0	Normal	
6	Low Battery level	
7	Motor error	
8	Throttle error	
9	Controller error	
10	UART receive error	
11	UART receive error	

## **The Electrical System is Now Ready!**

- Fold the kickstand from the ground, then sit on the seat. Put one foot on the pedal and the other on the ground.
- Now, start pedaling and the engine will go into action. There will be a faint rustle of the pass-through.
- To maintain battery life, do not use it until its end. When the battery meter flashes, turn off the power switch and use the pedal as a regular bicycle. After recharging, you can ride again with the electric motor.
- Back Injury: The rear of the bike is not intended to carry people. Maximum load is up to 25 kg, and the luggage should be tied with straps and tested during riding.
- Park in a safe place that is not an obstacle to vehicles or pedestrians. Place the bike on the kickstand, disconnect the power with the main switch and pull the key out of the lock.

- The bike must be locked with a massive lock and difficult to steal. It is recommended to **take the battery with you.**

- **Charging:** The battery must be charged only with the charger supplied with the bike. A lithium battery is only charged by a charge to lithium batteries and not by other charger. **The battery must be charged with GUANZHOU ELECTRONICS CORPRATION P / N; S12**

**Charging with a different charger can damage and void battery warranty.**

Do not open the battery or charger for testing or repair! **Bring to repair shop for testing!**

- Charging takes up to 6 hours, depending on battery status. The battery can be charged both on and off the bike.

- The charging cable must first be connected to the battery and then to the mains socket.

- When the charge indicator light is red, the battery is charging. When the charge light turns green, the battery is full and **must be disconnected** from the power source. When charging, the battery must be properly positioned and not fall or be damaged.

- **The charger becomes hot during charging. Keep it away from any flammable materials and keep the vents unblocked**

- Be sure to properly dispose of dead batteries at proper recycling plants and do not throw away in the trash.

- Before beginning the ride, check that all the indicator lights are working and the battery is locked in place.

- Check that the electrical contacts of the battery are always clean. Clean with a dry cloth without moisture.

- Check tire pressure regularly (40 PSI). Poor pressure will cause overuse of the battery and shorten cycling time.

- Do not drive in puddles. If water enters the engine, the controller or the battery house may become damaged. Water damage will void the warranty provided by the manufacturer.

\*Store the bike in a dry place. Moisture causes corrosion! **Do not leave the bike in the rain.** Immediately treat the corrosion with suitable oil! Water penetration into the electrical mechanisms will void the warranty.

- Do not put the bike in the sun especially when leaving the battery installed on the bike.

- Do not disassemble the electrical parts. **Disassembling them independently will void the manufacturer's warranty.**

- It is important to lubricate the moving mechanical parts such as the wheel hinges, transmission and gears, cable connections to the brake pads, etc. Do not lubricate the electrical parts themselves!

- Brake maintenance: The right brake is responsible for braking the rear wheel. The left brake is responsible for braking the front wheel. Always check if the brakes are normal and are optimally tuned.

- An unintentional braking creates unnecessary and harmful resistance to the bicycle and the life of the electrical system!

- In picture 6 you can see a stretched handle in optimal position.

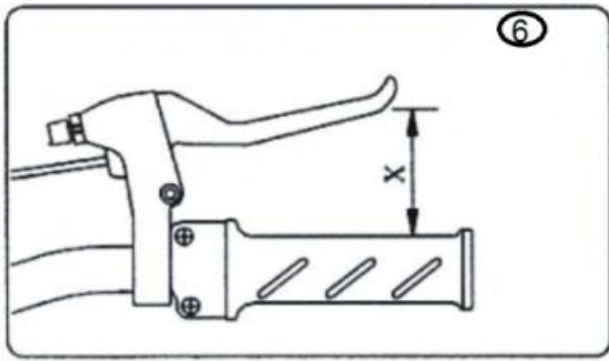

In addition, you can access any authorized bicycle shop to handle the mechanical parts of the bike but not the electrical parts.

**The electrical parts can only be handled by a workshop authorized by the importer.**

**National safety regulations must be obeyed.  
The bike is designed for riding in the city and in riding paths.**

For your safety, please wear a helmet!



Any change to the bike without the importer's approval will result in cancellation of warranty!

Proper maintenance should be upheld by the bike owner:

### **Bicycle Cleaning**

For the bike to serve you properly, you may want to clean it of sand and mud. If you cannot clean the entire bike, it is necessary to clean the drive systems (chain, wheels front and rear).

- **Cleaning frequency:** once in three or four significant rides or after each ride where the bike returns with sand or mud. You can use sponge and water bucket, solvent for grease, kitchen dishwashing sponge, rags, special brush with hard fibers.
- **Rinse:** Rinse all parts of the bike using a sponge. The hard brush is designed to remove heavy dirt from the wheels, pedals, etc.
- **Drying:** Dry the bike with the rags and place them in direct sunlight until fully dried (preferable if not washed at night or in stormy weather). Immediately after washing and drying, lubricate the chain. It is recommended to clean brakes with a dedicated material for brakes.

Mechanical and Electrical Components		Electronic Specifications	
Frame	100% Aerospace aluminum 6061	Motor :HT 350 Watt Brushless (High Speed)	
Type	folding electric bicycles		
Tires with light reflectors	20" made by <b>KENDA</b> 2.125		
Rims	100% double-sided aluminum	Controller : (PAS) "Smart" controller - computerized with pedal assistance according to the European standard	
Front brake	Green Bike - Hydraulic disk brake		
Rear brake	Green Bike - Hydraulic disk brake		
Gears	Transmission 6 Made by 		
Front fork	Made by <b>Double Crown</b>	Battery: 48 Volts 15.9 Amps Lithium Ion	
Ergonomic seat	Wide adapted for urban electric ride with shock absorber	Intelligent Charging Charge (Computerized Control) 1-6	
Front and back lights	LED switch with control switch Built-in electric horn	The "Crank" axis is made by 	
Fenders	Aviation aluminum 6061	<b>Performance</b>	
Crank	Nickel-plated aluminum arch	<b>Mph set according to standard 19.5 mph maximum speed</b>	
Chain	Stained stainless steel  <i>Easy Life Easy Ride!</i>	The driving range for each load is 35-65 miles per charge, subject to road conditions for a person weighing up to 155 lbs. at 15 mph	
Kickstand	100% steel	Net weight: 54 Lbs.	



Lithium Li-On Battery 48V-15.9Ah Made by Boston Power U.S.A

Charger model 48-30 48V 110V-Ah

Made by Guangzhou Electronic Corporation



## **Common Problems and Solutions**

- Problem 1: After turning on the main switch, the lights do not turn on and the bike does not move electrically.

- o Cause: The battery poles are not properly connected or a fuse is burned.

Solution: Check the battery contacts if they are dirty and should be cleaned. If the problem is not resolved, check the battery fuses.

- Problem 2: After turning on the main switch, the lights turn on but the bike does not move with power:

- o Cause: Check if the wires coming out of the controller are well connected (only to be handled by an expert technician)

- o Solution: Make sure cable connections are stable and strong. If the problem is not resolved, check for a break in the wires coming out of the controller.

- Problem 3: The motor rotates on its own after opening the main switch.

- o Cause: The controller is malfunctioning or there is a short circuit in the electrical system or disconnection of the wires.

- o Solution: If there is damage to the controller, contact the diagnostic service center and / or replace the controller.

- Problem 4: Engine power is low, travel distance is not satisfactory even after full charge

- o Cause: Tire pressure is too low. The pressure is 40 PSI and / or a large portion of the ride is on the rise or against the wind. The battery may be old and weak or a curved wheel is inhibiting the brake discs.

- o Solution: Add air to the tires to correct pressure and / or replace the inner tube. Check if the brake is on the wheel and release. Wheel balancing may be required in a professional workshop.

- Problem 5: When charging the plug does not go into the outlet and / or the charging indicator light does not turn on.

- o Reason: a. There is no power supply from the power source at home due to the automatic fuse or power failure. b. The plug is not properly inserted into the socket.

- o c. The fuse is burnt or the charger is damaged.

- o Solution: Check the socket plug connection, replace the power supply source to another outlet. If the problem is not resolved, bring both the charger and battery to the service center for diagnosis and repair.

- Problem 6: The charger is connected to the battery but the indicator light is off.

- o Cause: A 15-amp fuse of the battery house is burnt or the connection to the battery outlet is improperly charged.

o Solution: After testing the power source (wall outlet) or replacing the charger, the charger and battery must be brought to a service center.

**Remember:**

**Do not allow another rider on bike.**

**Disconnect the charger from the power source at the end of each charge.**

**Do not leave a bike / battery charging unattended.**

**The bike is a vehicle – Ride wisely and carefully**

**Always at your Service!**



## Dear Client,

**Green bike – Electric Motion**. welcomes you on the purchase of the model: HF 201– 48N / HF 202-48N electric bicycle

is happy to be at your disposal for maintenance and fulfillment of manufacturer's warranty if necessary. Please carefully read the following warranty conditions.

The warranty provided by Greenbike Company is a comprehensive warranty for all mechanical assemblies and all electronic components of the bike provided that the fault is caused by reasonable use and the bicycle is maintained according to the user manual alone.

Please consider the following-

\* The warranty will enter into force only after "activation" on the company's website, while filling in all the details as explained on the web page [GreenBikeElectric.com](http://GreenBikeElectric.com) within 30 days of purchasing the bicycle.

\* The warranty for the frame, motor controller and the battery is 12 months.. There is no warranty for the battery that has been 24 months since its production date at the bottom of the battery. **The warranty is contingent on the existence of a warranty certificate signed by the store where it was purchased with a purchase receipt stating the serial number of the frame and battery.**

\* The warranty will be canceled if electrical or mechanical changes are made without the written permission unless by a certified **Greenbike- Electric Motion** technician, including battery replacement / opening, or change in any other component.

\*The warranty will be **canceled** if the use is unreasonable and not in accordance with the instructions: in the event of a crash due to accident or fall, in the event of neglect of the maintenance required, in case of natural damages, in the event of exposure of the bike to humidity or heat without adequate protection from rain, mud and direct sunlight.

\* The warranty will be canceled if a non-original charger is used to charge the battery.

\* The responsibility for the components of the electrical system will be canceled if mechanical condition resulting from poor use or maintenance or the manner of use contributed to the load on the electrical system. (Eg ... a curved or broken wheel)

\* **Green bike - Electric Motion is not responsible for any damage caused to a third party as a result of the use of an electric bicycle or any damage caused to the rider as a result of an accident or use contrary to the instructions of the User's Guide, including indirect damage or expenses incurred by the cyclist .**

## Further Clarification of the Warranty

\* The warranty does not include the maintenance, direction or replacement of parts resulting from reasonable wear or use of bicycles. Including internal replacement in the event of a flat tire, worn tire, pads, cables, a disc brake or any other part whose wearout results from wear and tear.

\* The warranty does not include the replacement of a part or repair resulting from external trauma or a fracture resulting from an accident or a fall, including , pulling cables from the electrical components, abrasion of the power cord, short circuit from the national electrical system . Or any damage caused by an external blow

\* **Green Bike- Electric Motion** reserves the right to decide whether to replace the damaged part with a new or renewed one at its discretion.

\* **Green Bike- Electric Motion** reserves the right to cancel liability and refuse to provide service in the following cases:

- If the customer refuses to perform maintenance or repair that may endanger the rider including a paid repair (eg brakes)

- **In any case of verbal violence or other violence against a Greenbike – Electric motion employee or distributor**

The warranty is given at **Greenbike- Electric Motion** workshop only or at a authorized workshop approved by Green Bike – Electric Motion , during the hours of operation, according to the work procedures, response times and pricing available to the customers in the website :

[www.GreenBikeElectric.com](http://www.GreenBikeElectric.com) . The responsibility for transporting the bikes to the workshop and returning to the customer's home is the customer's responsibility only and at his own expense

**For any questions or requests for clarification or reporting, please contact us:**

Green Bike – Electric Motion

Main Office: 6059 Vantage Ave North Hollywood CA

Phone: (310) 254-6041

Email: [office@GreenBikeElectric.com](mailto:office@GreenBikeElectric.com)

Website: [GreenBikeElectric.com](http://GreenBikeElectric.com)

## Warranty

To: **Green Bike – Electric Motion** ,

I hereby inform you that I purchased a **LEGEND48-HD** (HF-201-48N)

In the shop \_\_\_\_\_ Street and number \_\_\_\_\_

City \_\_\_\_\_ ZIP \_\_\_\_\_ State \_\_\_\_\_

Invoice No. \_\_\_\_\_ Date of purchase \_\_\_\_\_.

Serial number of the bike (the number is stamped under the handlebar) \_\_\_\_\_ (last 7 digits)

Serial number of battery \_\_\_\_\_ (last 4 digits)

I will ask you to activate for me the warranty for the bike I purchased

Buyer Name \_\_\_\_\_ Family Name \_\_\_\_\_

\_\_\_\_\_ Cell \_\_\_\_\_

Email \_\_\_\_\_

**I confirm that I received a safety and maintenance briefing and that they gave me a 'User's Manual'.**

**I confirm that I have read the manual. Customer's signature**

\_\_\_\_\_

**Thanks for joining the green revolution of Green Bike – Electric Motion .**



[www.GreenBikeElectric.com](http://www.GreenBikeElectric.com)