

TOBY

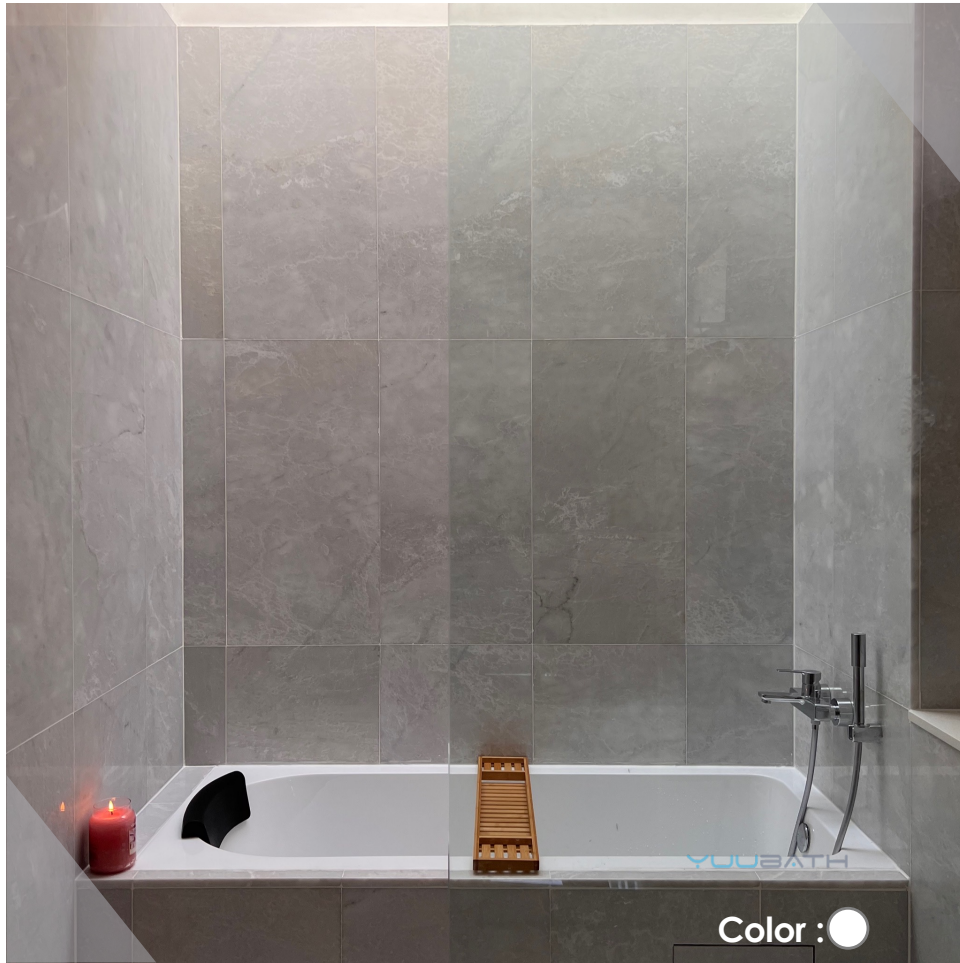

Material

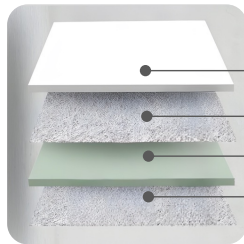

- 4mm Acrylic (PMMA) layer
- Fiberglass Insulation Layer
- Epoxy Resin Structure Enhanced Layer
- Thicken Fiberglass Resin Polymer (FRP) Insulation Layer

Overall Thickness : Between 6mm to 8mm

Features



- Dome cap center pin clicker waste plug
- Extendable drainage hose

Optional



- PU Bath Pillow



- SS304 Grip Bar



- Bamboo Bath Caddy
Non-Adjustable 730mm

TOBY 1600

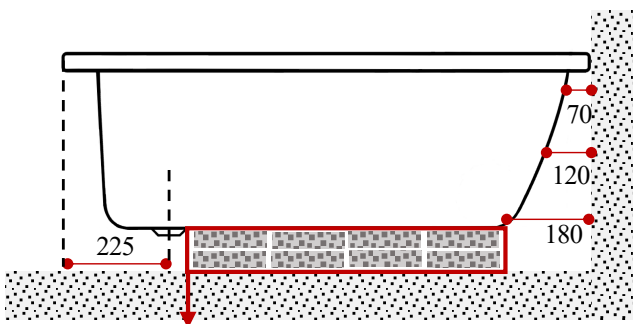
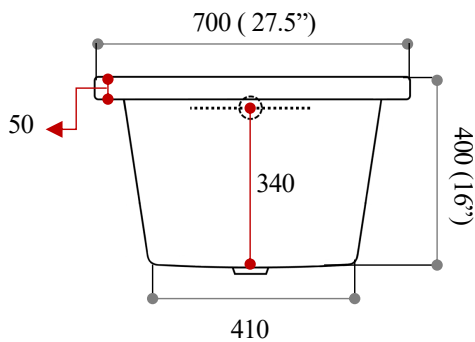
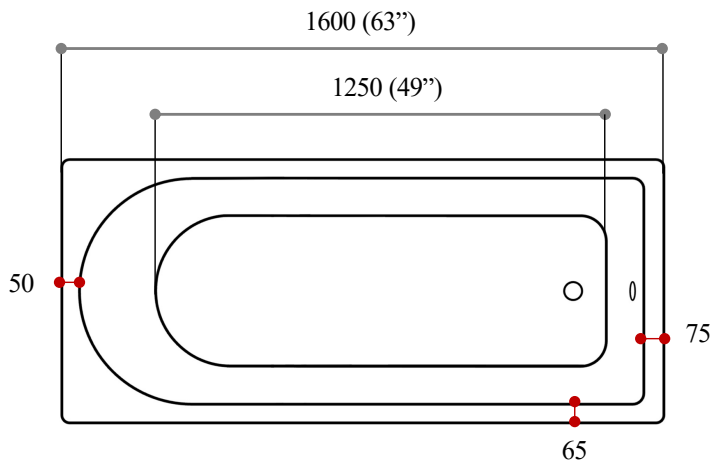

RECOMMENDED:

- Provide bathtub base with **maximum** support
- Raised height of 120 – 150mm



YUUBATH

Key Information

- Built-in Acrylic Bathtub with anti-slip base
- Single ended drainage point
- Indoor use
- 1600L x 700W x 400Hmm
- Approx. 150 Litres | 40 Gal

INSTALLATION

- Drop-in
- Top Mount
- Semi-recessed
- Recessed

** Tolerance +/- 5mm

** Not drawn to scale

** Dimensions in millimeters (mm)

** Illustrations and data specifications are not binding in detail