

# TOBY

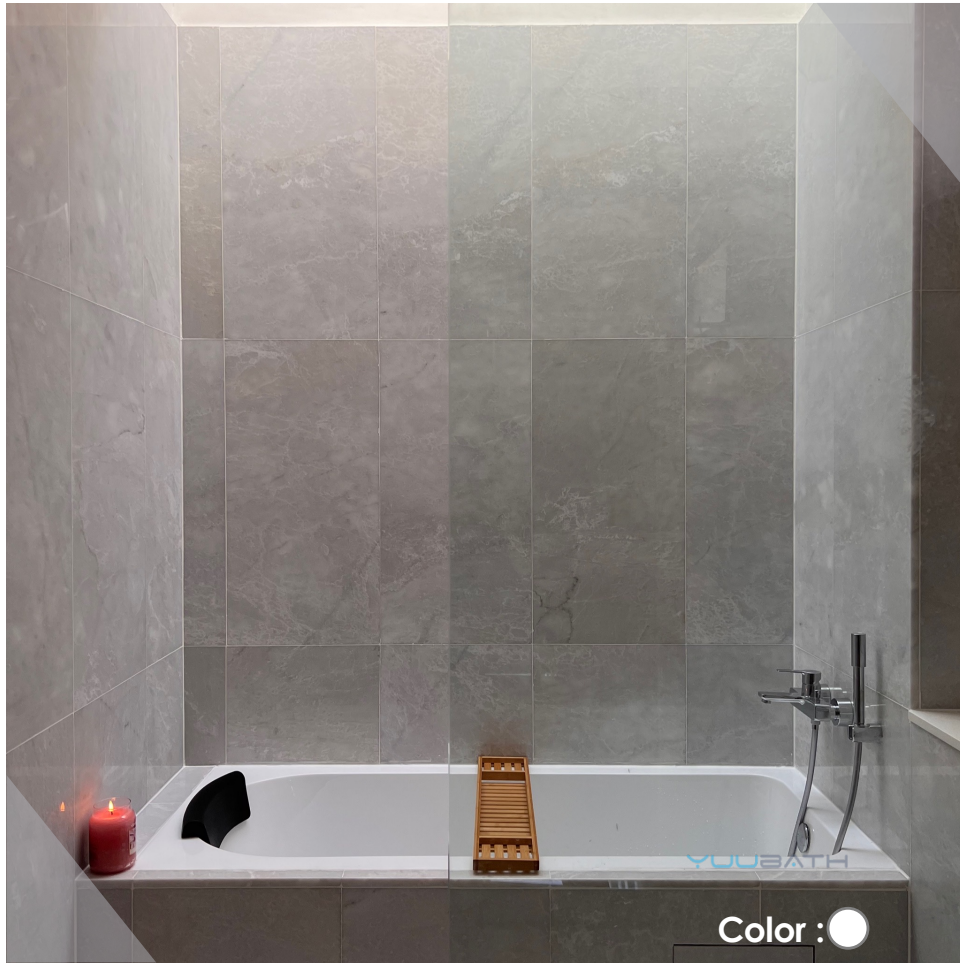

## Material

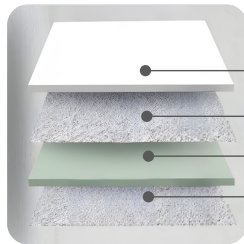

- 4mm Acrylic (PMMA) layer
- Fiberglass Insulation Layer
- Epoxy Resin Structure Enhanced Layer
- Thicken Fiberglass Resin Polymer (FRP) Insulation Layer

**Overall Thickness :** Between 6mm to 8mm

## Features



- Dome cap center pin clicker waste plug
- Extendable drainage hose

## Optional



- PU Bath Pillow



- SS304 Grip Bar



- Bamboo Bath Caddy  
Non-Adjustable 730mm

# TOBY 1300

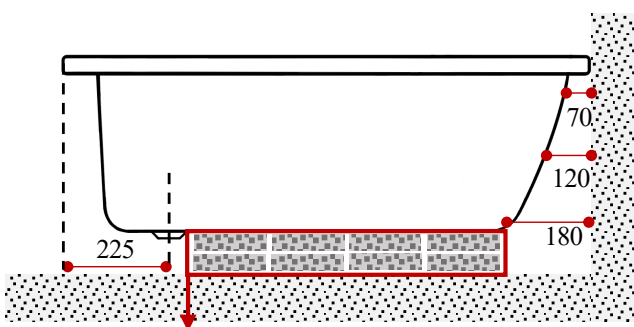
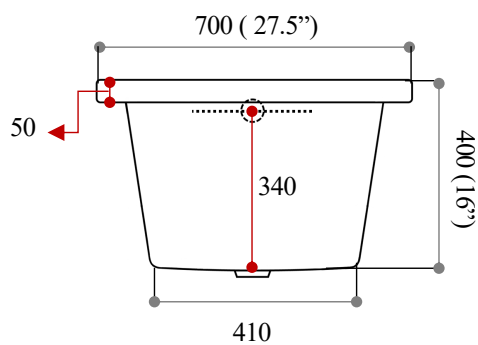
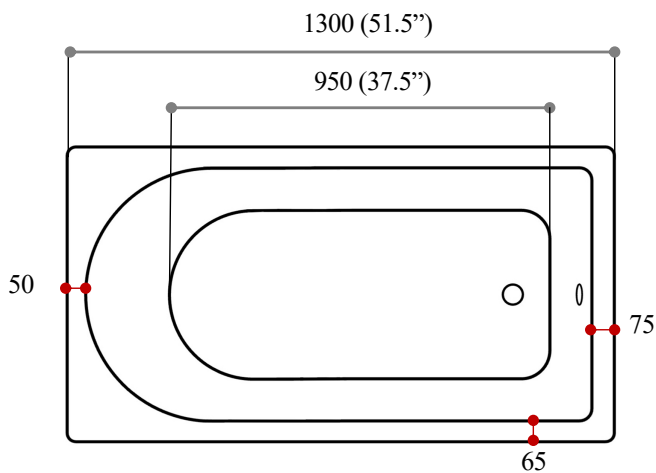

## RECOMMENDED:

- Provide bathtub base with **maximum** support
- Raised height of 120 – 150mm



YUUBATH

## Key Information

- Built-in Acrylic Bathtub with anti-slip base
- Single ended drainage point
- Indoor use
- 1300L x 700W x 400Hmm
- Approx. 120 Litres | 32 Gal

## INSTALLATION

- Drop-in
- Top Mount
- Semi-recessed
- Recessed

\*\* Tolerance +/- 5mm

\*\* Not drawn to scale

\*\* Dimensions in millimeters (mm)

\*\* Illustrations and data specifications are not binding in detail