



ProVideo Catalogue

PROVIDEO



Blackmagic URSA Mini Pro 4.6K G2

- Super 35MM Sensor
- EF Mount
- CFast
- Super 35MM Sensor
- EF Mount
- CFast



Blackmagic URSA Mini Pro 4.6K G2

- Super 35MM Sensor
- EF Mount
- CFast
- Super 35MM Sensor
- EF Mount
- CFast



PROVIDEO

Blackmagicdesign



Pocket Camera 6K Pro



KPG

PTZ Camera



Panasonic

PANASONIC PTZ – AW-UE150W/K

- 1"-Type MOS Sensor
- Up to UHD 4K 60p & HD Simultaneous Out
- 12G-SDI, HDMI, Fiber & IP Transmission
- V-Log Out & UHD Crop with v2.28 Update



Panasonic

Panasonic 4K NDI Pro PTZ Camera

- 1/2.5" 4K MOS Sensor
- HDMI, 12G-SDI, NDI & NDI|HX Output
- 24x Optical Zoom, Capture up to UHD 4K
- 3.3-74.1° Horizontal Field of View



Panasonic

Panasonic AW-HE145 Integrated PTZ Camera

- 1" Full HD MOS Sensor
- 20x Optical, 10x Digital Zoom, 32x iZoom
- HDMI/3G-SDI/IP Video Out, 3.5mm Mic In
- RTMP/SRT Video Streaming



Panasonic

PANASONIC AW-UE80 4K Professional PTZ Camera

- Supports a wide variety of IP transmission protocols, including high bandwidth
- Supports 4K 50p/60p shooting
- Includes a wide-angle lens and 24x optical zoom
- Supports FreeD for building AR/VR systems



JVC

JVC KY-PZ400N 4K NDI|HX PTZ Remote Camera

- 1/2.5" 4K CMOS Sensor, 12x Optical Zoom
- Capture up to UHD 4K 3840 x 2160p30
- HDMI, 3G-SDI & NDI|HX Video Output
- 255 Presets, 3.5mm Stereo Audio In/Out



JVC

JVC KY-PZ200 HD PTZ Remote Camera

- 1/2.8" HD CMOS Sensor, 20x Optical Zoom
- Resolution Capture up to 1920 x 1080p60
- HDMI/3G-SDI/USB Video Output, PoE Power
- 255 Presets, 3.5mm Stereo Audio In/Out



JVC

JVC RM-LP100 Remote PTZ Camera

- 6K Full-Frame Exmor R CMOS Sensor
- 15 Stops of Dynamic Range, Dynamic HDR
- DCI 4K and UHD 4K up to 59.94p
- HD Recording up to 150/180 fps



RGBlink®

RGBlink HDMI/SDI/NDI 1080p PTZ Camera

- 1/2.8" HD CMOS 2.07 MP Sensor
- Capture Resolutions up to 1920 x 1080p60
- 20x Optical Zoom, 10x Digital Zoom
- HDMI, SDI, NDI & IP Stream Video Output



Canon

Canon CR-X300 Outdoor 4K PTZ Camera

- Capture up to UHD 4K30 / 1080p60 Video
- 8.29MP 1/2.3" CMOS Sensor with Hybrid AF
- HDMI, 6G-SDI & IP/NDI Video Output
- IP65-Rated Dust/Water-Resistant Housing

Handheld Camera



SONY

Sony PXW-Z280 4K 3-CMOS 1/2" Sensor XDCAM Camcorder

- Three 1/2" Exmor R CMOS Sensors
- 4K 60p Recording
- Integrated 17x Optical Zoom Lens
- Electronic Variable ND Filter



SONY

Sony PXW-Z150 4K XDCAM Camcorder

- Single 1" Exmor RS CMOS Sensor
- UHD 4K (3840 x 2160) up to 30p
- HD up to 120 fps
- Sony G Lens with 12x Optical Zoom



SONY

Sony PXW-Z90V 4K HDR XDCAM with Fast Hybrid AF

- Single 1" Exmor RS CMOS Sensor
- UHD 4K (3840 x 2160) up to 30p
- 4K HDR with Hybrid Log-Gamma (HLG)
- 3G-SDI Output, 2.4/5 GHz Live Streaming



SONY

Sony HXR-NX5R NXCAM Professional Camcorder with Built-In LED Light

- 3 x 1/2.8" CMOS Sensors
- 1080p/1080i/720p
- XAVC-S, AVCHD 2.0, DV Codecs
- Integrated Wide Angle 20x G-Lens



SONY

Sony HXR-NX80 4K NXCAM with HDR

- Single 1" Exmor RS CMOS Sensor
- XAVC S 4K (3840 x 2160) at 100 Mb/s
- 2.4 GHz Wi-Fi, Live Streaming
- 4K HDR with Hybrid Log-Gamma (HLG)



SONY

Sony HXR-MC88 Full HD Camcorder

- 14.2MP 1" Exmor RS CMOS Sensor
- Record up to Full HD 1080p60 at 28 Mb/s
- 29mm ZEISS Wide-Angle Lens
- OLED Viewfinder with 2.36 Million Dots



JVC

JVC GY-HM180 Ultra HD 4K Camcorder with HD-SDI

- 1/2.3" 12.4MP CMOS Sensor
- Record UHD 4K 24/30p at 150 or 70 Mb/s
- Live UHD 4K Output via HDMI
- 4:2:2 1080p Video up to 60p at 50 Mb/s



Canon

Canon XF605 UHD 4K HDR Pro Camcorder

- 1" CMOS Sensor, 4:2:2 10-Bit
- H.265/H.264 MP4 Format, XF-AVC
- UHD 4K up to 60 fps, 1080p to 120 fps
- iOS App | 15x Optical/30x Digital Zoom



Canon

Canon XA11 Compact Full HD Camcorder with HDMI

- Native 1920 x 1080, 1/2.84" CMOS Sensor
- 20x HD Zoom Lens
- Canon DIGIC DV 4 Image Processor
- Dynamic Image Stabilization



JVC

JVC GY-HC550 Handheld Connected Cam 1" 4K Broadcast Camcorder

- Broadcast Overlay, MPEG-2 Recording
- Built-In Wireless LAN, Zixi, and GPS
- 1" CMOS Sensor, 20x Optical Zoom



Blackmagicdesign

Blackmagic URSA Mini Pro 4.6K G2

- 12.1MP Full-Frame CMOS Exmor R Sensor
- UHD 4K up to 120 | 1080p up to 240
- Compact Form for Cage-Free Operation
- 10-Bit 4:2:2 XAVC S-I, 16-Bit Raw Output



Canon

Canon EOS 5D Mark IV DSLR Camera with Canon Log

- 30.4MP Full-Frame CMOS Sensor
- DIGIC 6+ Image Processor
- DCI 4K Video at 30 fps; 8.8MP Still Grab
- Canon Log Gamma; View Assist Function



Canon

Canon EOS 7D DSLR Camera with 18-135mm Kit

- 18 MP APS-C CMOS Sensor
- Dual DIGIC 4 Image Processors
- 3.0" 920k-Dot Clear View II LCD Monitor
- Full HD 1080p Video Recording at 30 fps



SONY

Sony FX3 Full-Frame Cinema Camera

- 12.1MP Full-Frame CMOS Exmor R Sensor
- UHD 4K up to 120 | 1080p up to 240
- Compact Form for Cage-Free Operation
- 10-Bit 4:2:2 XAVC S-I, 16-Bit Raw Output



Blackmagicdesign

Blackmagic Pocket Cinema Camera 4K

- 4/3"-Sized HDR Sensor
- DCI 4K60, 2.8K80 Raw in 4:3 Anamorphic
- Dual Native 400/3200 ISO / up to 25,600
- Up to 2.6K 120 Raw for Super16 Lenses



Blackmagicdesign

Blackmagic Pocket Cinema Camera 6K

- Active Canon EF/EF-S Mount
- Super 35-Sized HDR Sensor
- Record 6K 6144 x 3456 up to 50 fps
- Dual Native 400 & 3200 ISO to 25,600



Blackmagicdesign

Blackmagic Pocket Cinema Camera 6K Pro

- Bright 1500 cd/m² Tilting HDR LCD
- Super35 HDR Sensor, Gen 5 Color Science
- Dual XLR Inputs, Canon Active EF Mount
- NP-F570 Battery, Built-In ND Filters

Broadcast Camera



SONY

Sony FX6 Full-Frame Cinema Camera

- 4K Full-Frame 10.2MP CMOS Exmor R Sensor
- DCI 4K60p | UHD 4K120 | 1080p240
- 15+ Stops of Dynamic Range in S-Log 3 EI
- Compact Form Weighs Just <2 lb



SONY

Sony PXW-FS7M2 Camera System

- Super 35-Sized CMOS Sensor
- Locking Sony E-Mount
- Integrated Electronic Variable ND Filter
- DCI 4K (4096 x 2160) up to 59.94p



JVC

JVC GY-HC900C20 HD Connected Camcorder

- 4.6K Super 35 HDR CMOS Sensor
- 4.6K up to 120 fps, 300 fps at 1080p
- 15 Stops of Dynamic Range at 3200 ISO
- USB-C Expansion Port for External Disks



SONY

Sony PXW-FX9 XDCAM 6K Full-Frame Camera System

- 6K Full-Frame Exmor R CMOS Sensor
- 15 Stops of Dynamic Range, Dynamic HDR
- DCI 4K and UHD 4K up to 59.94p
- HD Recording up to 150/180 fps



Blackmagicdesign



Blackmagic Studio Camera 4K Pro

- Micro Four Thirds Lens Mount
- Capture up to UHD 4K 3840 x 2160p60
- 7" High-Brightness HDR Touchscreen LCD
- Record to External USB Type-C Disks



Canon

Canon EOS C200B Cinema Camera with Accessory Kit

- Super 35mm CMOS Sensor
- Dual-Pixel CMOS AF Technology
- Dual DIGIC DV 6 Processors
- DCI and UHD 4K, 1920 x 1080



Canon

Canon EOS C500 Mark II 5.9K Full-Frame Camera Body

- Full-Frame CMOS Sensor, DIGIC DV 7 Chip
- Full-Frame, Super 35, and Super 16 Modes
- DCI 4K/2K, UHD 4K, and HD Modes
- User-Changeable Lens Mounts



Blackmagicdesign



Blackmagic URSA Broadcast G2

- 6K CMOS Sensor, Dual Native ISO
- 2/3" B4 Lens Mount & Active EF Mount
- 6K Blackmagic RAW Recording
- Records to ProRes, H.265/264

Camera Bags



Bags



Sachtler Camera Rollpak

- Fits Camcorders up to 18" Long
- 900D Cordura & Ballistic Nylon Exterior
- Built-In Wheels & Extendable Trolley



E-Image Oscar S50 Shoulder Small Camera Case

- Ergonomic design of shape and shoulder padding, make it comfortable to carry.
- Wide opening for fast and easy access to contents.



E-Image C30 Harmony Shoulder Large Camera Case

- Wide opening for fast and easy access to contents.
- Interior and exterior pockets for accessories.
- Interior and exterior pockets for accessories.



SHAPE Camera Bag with Removable Pouches

- Ergonomic backpack system
- Padded shoulder strap for easy carrying
- Built-in wheels
- Wide opening for fast and easy access



ORCA OR-100 Rain Cover for Sony PXW-X70

- Protects video camera from rain, dust, and other elements
- Easy to slip onto a camera
- Inflatable skeleton system allows for better



Sachtler SR410 Rain Cover for Small Video Cameras

- Quick and Simple Setup
- Clear Polyurethane for Visible Controls
- Access Lens, LCD Screen, and Controls
- Rigid Front Hood Section



Sachtler Camporter Camera Bag (Large)

- Fits Cameras up to 20.5" Long
- Protects Camera with Attached Microphone
- Quick-Access Extra Wide Opening
- Three Removal Internal Dividers

Bags



NANUK
PROFESSIONAL PROTECTIVE CASES

Nanuk 933 Case with Dividers and Lid Organizer

- Watertight, Lightweight, and Durable
- Powerclaw Latches & Purge Valve
- Two Holes for User-Supplied Padlocks



PELICAN

Pelican 1535AirTP Wheeled Carry-On Hard Case

- Waterproof, Crushproof & Lightweight
- 20.4 x 11.2 x 7.2" Interior Space
- Made of Super-Light HPX2 Polymer
- Updated Push-Button Latching System



PELICAN

Pelican 1615AirTP Wheeled Hard Case

- Waterproof, Crushproof & Lightweight
- 29.6 x 15.5 x 9.4" Interior Space
- Made of Super-Light HPX2 Polymer
- Updated Push-Button Latching System



PELICAN

Pelican 1510 Carry-On Case with Foam Set (Black)

- Quick and Simple Setup
- Clear Polyurethane for Visible Controls
- Access Lens, LCD Screen, and Controls
- Rigid Front Hood Section



PELICAN

Pelican 1010 Micro Case (Clear Black with Colored Lining)

- Holds Small Electronics, Valuables
- Unbreakable, Watertight, Airtight Case
- Submersible to 3.3' for 30 Minutes



PELICAN

Pelican 1650NF Case without Foam (Black)

- Unbreakable, Watertight, Hard Case
- Ultra-high Impact Structural Copolymer
- Empty Interior
- Built-in Automatic Purge Valve



ORCA
Gear in motion

ORCA Small Hard-Shell Accessories Bag (Black)

- Holds Audio & Photo Accessories
- 3 Touch-Fastening, Padded Dividers
- Removable Organizational Panel
- Offers 360° Impact Protection



PELICAN

Pelican iM2100 Storm Case with Foam (Black)

- HPX High Performance Resin Case
- Multilayer Cubed Bottom Foam
- Dent-resistant and Shatter-resistant

Lenses

Canon

Canon





Rokinon 24, 35, 50, 85mm T1.5 Cine DS Lens Bundle for Canon EF Mount

- 24, 35, 50, 85mm Cine-Style Lenses
- Canon EF Mount
- Covers Full-Frame Sensors
- T1.5 to T22 Exposure Range



Sirui 24mm f/2.8 Anamorphic 1.33x Lens (X Mount)

- Covers Micro Four Thirds/APS-C Sensors
- Suitable for 4K Image Capture
- 2.4:1 De-Squeezed Format; 8-Blade Iris
- Schott Optical Glass with Nano Coatings



Canon EF-M Lens Adapter Kit for Canon EF / EF-S Lenses

- ENG Telephoto Lens
- For Use with 2/3" Cameras
- 20x Zoom
- Focal Length of 8.5-170mm



DJI 50mm f/2.8 ASPH LS Lens

- Works with Zenmuse X7 Camera
- Lens Hood & Balancing Ring Included



Canon
Metabones Canon EF/EF-S Lens to Sony E Mount T Smart Adapter (Fifth Generation)

- ENG Telephoto Lens
- For Use with 2/3" Cameras
- 20x Zoom
- Focal Length of 8.5-170mm



Canon
Canon KJ13x6B KRSD HDgc 13x 2/3" ENG/EFP Lens

- Ergonomic backpack system
- Padded shoulder strap for easy carrying
- Built-in wheels
- Wide opening for fast and easy access



TAMRON
Focus on the Future

Tamron Compact 5MP C-Mount 25mm Lens

- For Machine Vision Cameras
- For 1/1.2" & 2/3" Format Sensors
- 5MP-Equivalent Resolution
- Compact 29mm Diameter Lens Barrel

FUJINON
FUJIFILM
Fujinon XA20sx8.5BRM-K3 HD Professional Lens

- ENG Telephoto Lens
- For Use with 2/3" Cameras
- 20x Zoom
- Focal Length of 8.5-170mmf



Lens



Canon

Canon EF-M Lens Adapter Kit for Canon EF / EF-S Lenses

- ENG Telephoto Lens
- For Use with 2/3" Cameras
- 20x Zoom
- Focal Length of 8.5-170mm



SIRUI

Sirui 50mm T2.9 Full Frame 1.6x Anamorphic Lens (Sony E)

- Covers Full-Frame Sensor
- Aperture Range: T2.9 to T16
- 2.4:1 & 2.8:1 De-Squeezed
- Blue Streak Effects



Canon

Canon CN-E 35mm T1.5 L F Cinema Prime Lens (EF Mount)

- EF Mount Prime Designed for Cine-Use
- For Canon C-Series and Full-Frame DSLRs
- 11-Blade Rounded Diaphragm
- Stepless and Manual Diaphragm Ring



SIGMA

Sigma 18-35mm T2 High-Speed Zoom Lens (Canon EF)

- Covers Full-Frame & Super 35 Sensors
- T1.5 Maximum Aperture
- 11-Blade Iris
- Breathing Minimized Virtually to Zero



DZOFILM
MAKE YOUR MOVIE

DZOFilm VESPID Prime Cine 8-Lens Kit (EF Mount)

- 16, 25, 35, 50, 75, 100, 125mm Lenses
- Macro 90mm T2.8 Lens
- EF Mount
- Hard Case Included



ZEISS

ZEISS CP.3 35mm T2.1 Compact Prime Lens (Sony E Mount, Feet)

- Covers Full-Frame Format
- Sony E Mount
- T2.1 to T22 Aperture Range
- Geared Focus and Iris Control Rings

KPG

Lens



Canon

Canon EF 24-70mm f/2.8L II USM Lens

- Micro Four Thirds Format Lens
- EF-Mount Lens/Full-Frame Format
- Aperture Range: f/2.8 to f/22
- One Super UD Element, Two UD Elements
- Three Aspherical Elements



Canon

Canon EF 85mm f/1.8 USM Lens

- EF-Mount Lens/Full-Frame Format
- Aperture Range: f/1.8 to f/22
- Super Spectra Coating
- Ring-Type Ultrasonic Motor AF System



Canon

Canon EF 50mm f/1.8 STM Lens

- EF-Mount Lens/Full-Frame Format
- Aperture Range: f/1.8 to f/22
- Super Spectra Coating
- STM Stepping AF Motor



Canon

Canon EF-S 24mm f/2.8 STM Lens

- EF-S-Mount Lens/APS-C Format
- 38.4mm (35mm Equivalent)
- Aperture Range: f/2.8 to f/22
- One Aspherical Element

SAMYANG

Samyang 50mm T1.5 VDSLR AS UMC Lens for Micro Four Thirds

- Micro Four Thirds Format Lens
- 100mm (35mm Equivalent on MFT)
- Aperture Range: T1.5 - T22
- One Aspherical, One Hybrid Asph. Element



Tripod and Support



 **E-IMAGE**

E-Image 2-Stage Aluminum Tripod with GH06 Head

- Supports up to 13.2 Pounds
- 75mm Ball/Bowl
- GA752 2-Stage Legs with Mono-Lock Design
- 32.5-72.5" Height Range with Head



 **sachtler.**

Sachtler aktiv8T flowtech75 MS Tripod

- aktiv8T Touch & Go Fluid Head
- flowtech75 Tripod
- Mid-Level Spreader, Carry Handle, Bag
- SpeedSwap Clamp-Style Base



 **Manfrotto**

Manfrotto 502A Video Head, 546GB Tripod,

- 502A Pro Video Head with 755 Half Ball
- 546GB Tripod with Ground Spreader
- Red & Black Tripod Carry Bag
- 22 lb Payload, 8.8 lb Counterbalance



 **Vinten**

Vinten System Vision blue5 Head with Flowtech 75 Carbon Fiber

- Vision blue5 Fluid Head
- Load Capacity 12.1 to 26.5 Pounds
- ±90° Tilt Range
- Infinitely Adjustable Counterbalance



 **Manfrotto**

Manfrotto MVH500A Video Head, MVT502AM Tripod

- 502A Pro Video Head with 755 Half Ball
- 546GB Tripod with Ground Spreader
- Red & Black Tripod Carry Bag



 **E-IMAGE**

E-IMAGE EG15A TRIPOD KIT

- GA102 Two-Stage Aluminum Tripod Legs
- GH15 Fluid Head, 33 lb Payload
- Lightweight Collapsible Tripod Dolly
- 18 to 63" Tripod Legs' Height Range



 **sachtler.**

Sachtler Ace XL Tripod System with CF Legs & Ground Spreader

- 17.6 lb Capacity Fluid Drag Head
- 4.1" Sliding Plate Range
- 8-Step Counterbalance
- 3-Step + 0 Pan/Tilt Drag



 **E-IMAGE**

E-Image EI-7003 Universal Lightweight Tripod Dolly

- 88 lb Load Capacity
- 18.5" Working Radius
- For Split-Spiked and Single-Point Feet
- Individually Braked Wheels

E-Image EK610, 630 & 650 Professional Compact Tripod with Fluid Head



E-IMAGE

- 3-5kgs Payload
- 30.5 to 83" Height Range
- Dual-Stage Aluminum Legs with 75mm Bowl
- 65mm & 75mm Half Ball Fluid Head



Libec

Libec P110(B) Pneumatic Pedestal with P110 Column and DL-8RB Dolly

- Includes P110 Column
- Includes DL-8RB Dolly for Outside Use
- 66 lb Load Capacity



 **sachtler.**

Sachtler FSB 14T Mk II Touch & Go System with Pedestal C III

- FSB 14 MK II Fluid Head with Touch & Go
- Support Pedestal with Tripod Dolly
- Left-Handed Pan Handle Included



 **E-IMAGE**

E-IMAGE EP880XS & GH40PLUS & EI7008 Pedestal- Payload 40kg

- GA102 Two-Stage Aluminum Tripod Legs
- GH15 Fluid Head, 33 lb Payload
- Lightweight Collapsible Tripod Dolly
- 18 to 63" Tripod Legs' Height Range

TRIPODS

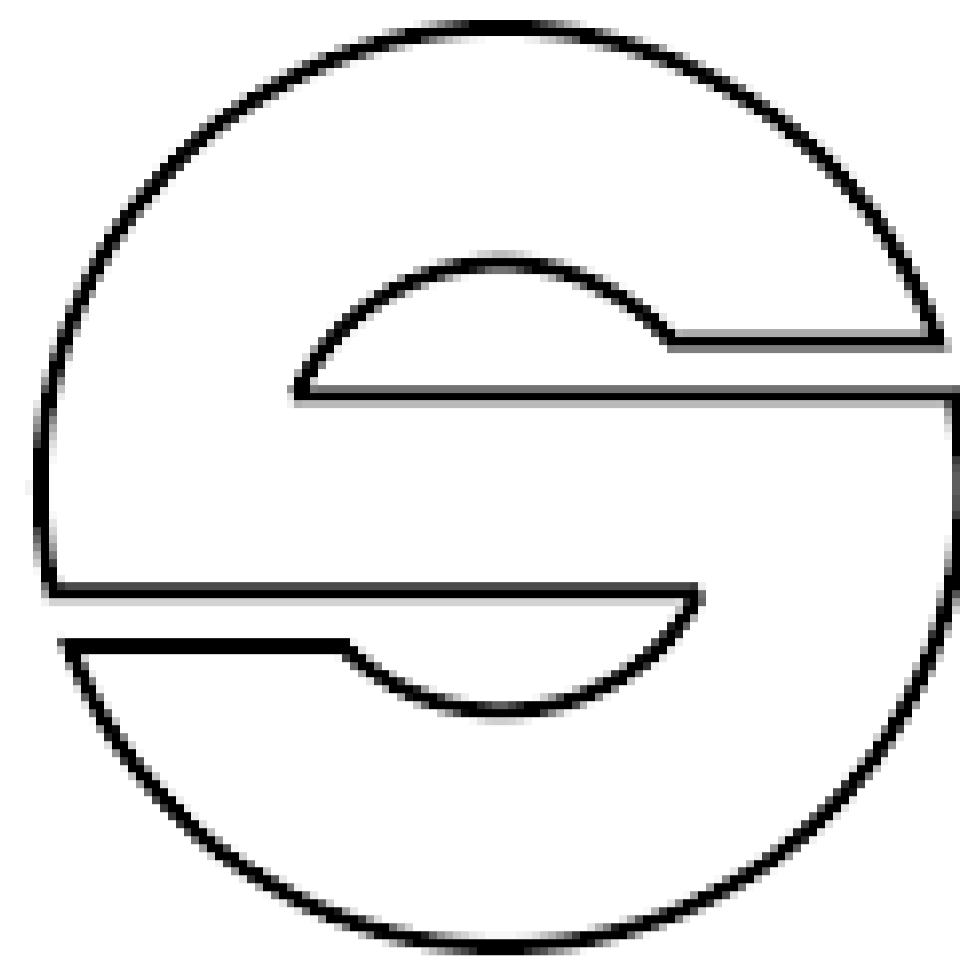

sachtler®

Release

Level

Lock



SACHTLER aktiv

Matt Boxes



SHAPE

SHAPE 4 x 5.6 Carbon Fiber Swing-Away Matte Box Set with Studio Rod Adapters

- Lightweight Carbon Fiber Construction
- 2 x 360° Rotating 4 x 5.65 Filter Stages
- 15mm LWS and 19mm Studio Rod Adapters
- 143mm Diameter Opening



TILTA

Tilta Mirage VND Kit

- Clamps onto Lenses with 95mm Diameter
- Suitable for Gimbals and Drones
- Accepts Tilta Circular 95mm Filter
- Variable ND Filter System Included



SmallRig

SmallRig Mini Matte Box Lite

- Compact Matte Box Weighing Only 3.8 oz
- Carbon Fiber Box and Top Flag
- Includes 4 x 5.65" Filter Tray
- Includes 67/72/77/82-95mm Adapter Rings



TILTA

Tilta 95mm Circular Polarizer for Mirage Matte Box

- Circular Polarizer Filter
- Designed for Mirage Matte Box
- Wireless Control via Optional Motor
- Fits Lenses with 95mm Front Diameter



ARRI

ARRI LMB F4 Filter Frame (4 x 5.65 / 4 x 4")

- For LMB 4x5, LMB-25 & MMB-2 Matte Boxes
- Holds One 4 x 5.65 or 4 x 4" Filter
- Non-Geared Filter Tray
- Spring-Loaded Filter Wedge



E-IMAGE

E-Image 4X4" Carbon Fiber Swing-Away Matte Box

- Carbon Fiber and Aluminum Construction
- Rotating 4 x 4 Filter Stage
- 15mm Rod Mounting
- Swing-Away Design

KPG

Monitors



LILLIPUT

Lilliput BM280-4K Carry-On 4K Monitor (V-Mount)

- 28" 3840 x 2160 10-Bit IPS LCD
- Supports NTSC/PAL, HD, and UHD 4K
- HDMI, SDI, DVI, and VGA Inputs
- 178° H/V Viewing Angler



LILLIPUT

Lilliput A7S 7" Full HD Monitor with 4K Support (Black Case)

- Circular Polarizer Filter
- Designed for Mirage Matte Box
- Wireless Control via Optional Motor
- Fits Lenses with 95mm Front Diameter



ATOMOS

Atomos Ninja V 5" 4K HDMI Recording Monitor

- Circular Polarizer Filter
- Designed for Mirage Matte Box
- Wireless Control via Optional Motor
- Fits Lenses with 95mm Front Diameter



Blackmagicdesign

Blackmagic Design Video Assist 7" 12G-SDI/HDMI HDR Recording Monitor

- Circular Polarizer Filter
- Designed for Mirage Matte Box
- Wireless Control via Optional Motor
- Fits Lenses with 95mm Front Diameter



SONY

Sony PVM-X3200 4K HDR Trimaster High-Grade Picture Monitor (32")

- Circular Polarizer Filter
- Designed for Mirage Matte Box
- Wireless Control via Optional Motor
- Fits Lenses with 95mm Front Diameter



JVC

JVC DT-N17F ProHD 17.3" Broadcast Studio LCD Monitor

- Circular Polarizer Filter
- Designed for Mirage Matte Box
- Wireless Control via Optional Motor
- Fits Lenses with 95mm Front Diameter

KPG

Batteries and Chargers



SWIT®

SWIT S-8i50 JVC SSL-JVC50-Type Battery

- 47Wh Lithium-Ion Battery
- 7.2V Output, 6.6Ah Capacity
- Supports up to 5.5A Draw
- For JVC GY-LS300, HM600/650 & HMQ10U



Blackmagicdesign



Blackmagic Design NP-F570 Battery

- Circular Polarizer Filter
- Designed for Mirage Matte Box
- Wireless Control via Optional Motor
- Fits Lenses with 95mm Front Diameter



Canon

Canon BP-A30 Battery Pack for EOS C300 Mark II, C200, and C200B

- 3100 mAh / 45 Wh Capacity
- Rechargeable Intelligent Li-Ion Battery
- Battery Contact Cover
- Push-Button Remaining Power Indicator



FARSEEING®

Farseeing NPF 970 (Replacement for Sony F970)

- L-Series Form Factor
- Compatible with Monitors and Lights
- For Select Sony Cameras



JVC

JVC SSL-JVC50 7.4V IDX Lithium-Ion Battery for JVC Camcorders

- For JVC GY-HMQ10 / 600 / 650 Camcorders
- 7.4 Volts
- 4900 mAh
- 37 Watt Hours



FARSEEING®

Farseeing FD-U60 Battery (Sony BPU-60 Generic)

- Compatible with: PMW-F3K, PMW-F3L, PXW-FS5, PXW-FS7, PXW-FS7K, PMW-100, PMW-150, PMW-200, PMW-300K1,



JVC

JVC LC-2J Dual Charger for SSL-JVC50 7.4V JVC Batteries

- Simultaneously Charges 2 SSL-JVC50s
- 12-19V DC Input
- 8.4V 1.6A DC Output



FARSEEING®

Farseeing DV Dual Channel Charger (Sony NPF-970 Batteries)

- Four level power display, each level shown in 25% increments.
- D-tap output with 14.8V, 150W, 10A (max output).
- All models have new standard

Batteries and Chargers



Anton Bauer Dionic XT 90Wh V-Mount Lithium-Ion Battery

- V-Mount Lithium-Ion
- 99Wh Capacity
- 12A Constant Current Capability
- 14.4V Nominal Voltage



SWIT 140Wh Pocket Battery with D-Tap and USB Outputs (V-Mount)

- Circular Polarizer Filter
- Designed for Mirage Matte Box
- Wireless Control via Optional Motor
- Fits Lenses with 95mm Front Diameter



PAGlink PL96e Battery

- 96 watt-hours, 14.8V 6.5Ah
- Rechargeable V-Mount Li-Ion battery
- Batteries in any state of charge can be linked to combine capacities



Farseeing FC-BP4 Quad Channel V-Lock Charger

- Circular Polarizer Filter
- Designed for Mirage Matte Box
- Wireless Control via Optional Motor
- Fits Lenses with 95mm Front Diameter



Farseeing FC-BP2 Dual Channel V-Lock Charger

- Input AC 90-240V, 47-63Hz
- Charger Output DC 16.8V 3A x 2
- Adapter Output DC 15V 4.5Ar



Fention FS-BP95 6600mAh/95Wh V-Lock Battery

- Circular Polarizer Filter
- Designed for Mirage Matte Box
- Wireless Control via Optional Motor
- Fits Lenses with 95mm Front Diameter



IDX System Technology 96Wh High-Load Battery

- 14.4V 96Wh V-Mount Batteries
- Handles up to 10A Loads
- Battery Circuit Protection
- Two Unregulated D-Tap



Video Lighting



Aputure

Aputure NOVA P300c RGBWW LED Panel with Rolling Case Kit

- NOVA P300c, 15.8 x 10.6 x 6"
- Weather-Resistant Hard Rolling Case
- M-F 9.8' Head Cable, AC Cable
- M-F 2' Head Cable, Control Box



ARRI

ARRI SkyPanel S60-C LED Softlight with Manual Yoke

- Panel Surface Area: 25.4 x 11.8"
- 115° Beam Spread, Rail Mount Adapter
- Color Temperature from 2800-10,000K
- Full Gamut Color Mixing



Godox

Godox ES45 E-Sport LED Light Kit

- 2800 to 6500K, CRI/TLCI: 96/97
- AC Adapter, Onboard Battery, Dims 0-100%
- iOS/Android Control, Detachable Remote
- Measures 14 x 9 x 2"



DRACAST

Dracast Kala Plus Series LED2000 Bi-Color LED Light Panel

- 2800 to 6500K Color, CRI/TLCI: 96+/97+
- 120°: Beam, Dims: 0 to 100%, Barndoors
- DMX512, 3-Pin In/Out
- Measures 24.4 x 15.3 x 3.14"



E-IMAGE

E-Image E-1060 (Dimmable & Colour Change Dials) LED light

- 1060PCS, 60W, 4100Lux@1m, 12000Lux@0.5m



CAME-TV

CAME-TV Boltzen 55W Focusable Fresnel Daylight LED Light

- Daylight Balance: 5600K
- Dimmable
- 4-Way Barndoors
- AC or Battery Power



DRACAST

Dracast LED1500 Bi-Color LED Fresnel with Wi-Fi

- Beam Angle: 15-60°
- Wireless Control via iOS & Android App
- USB Dongle
- 3200-5600K Color Temperature, CRI: 95



Aputure

Aputure Light Dome II (34.8")

- Hexadecagon Shape with 16 Steel Rods
- 2 Front Diffusers: 1.5 and 2.5 Stops
- Removable Inner Diffuser
- 40° Grid, Gel Filter Holder



Godox

Godox Softbox with Bowens Speed Ring and Grid (19.7 x 51.2")

- 3000-6000K Color Temp, 90+ CRI/TLCI
- Integrated Shoe Mount
- Flexible Phone Holder
- USB-Powered



E-IMAGE

E-IMAGE SOFTBOX SINGLE BULB 45W 220V 6500LCFL DAYLIGHT

- Beam Angle: 15-60°
- Wireless Control via iOS & Android App
- USB Dongle
- 3200-5600K Color Temperature, CRI: 98

Video Lighting



Aputure F10 Barndoors for LS 600d Fresnel Attachment

- 8-Way Design, 10"



Godox Barndoor Kit

- 8-Way Design, 10"



Impact 5-in-1 Collapsible Oval Reflector with Solid Gold

- Folds down to 1/3 of Open Size
- Translucent Diffusion Interior Panel
- Black, Silver, White & Gold Surfaces
- Includes Carry/Storage Case



Manfrotto Air Cushioned Alu Master Stand 1004BAC

- Quick-Stack System
- 4 Sections, 3 Risers



E-Image LCS-03 40" C-Stand

- With grip arm and grip head, big size T-Handle is ergonomic design for biggest torque.
- Ergonomic "T" shaped handles



E-Image HS03 Heavy Duty Stand (Square Tube) -L

- Triple function stand top with junior receiver, baby pin and baby receiver
- Compact top head with multi direction 16mm(5/8") light stud

Wireless Transmitter



Hollyland Mars 300 PRO HDMI Wireless Video Transmitter/Receiver Set

- Bolt LT 750 4K Transmitter
- Bolt 4K 750 12G-SDI Receiver
- Allows Output of 12G-SDI Video up to 4K
- Transmits up to 750' Line of Sight



Teradek Bolt 4K LT 750 3G-SDI Transmitter & Bolt 4K 750 12G- SDI Receiver Kit

- 400' to RX, 300' to App Line-of-Sight
- Transmit up to 1080p60
- Transmitter: HDMI Input & HDMI Loop-Out
- Receiver Has 2 x HDMI Outputs



Hollyland Cosmo C1 SDI/HDMI Wireless Video Transmission System

- Wireless Video Transmitter/Receiver Set
- Transmitter HDMI/SDI Input, SDI Loop Out
- Receiver HDMI & 2 x SDI Outputs
- OLED Screen, USB Type-C Power Input



Hollyland LARK 150 2-Person Compact Digital Wireless Microphone System (2.4 GHz, Black)

- For 2-Person YouTube & Content Creation
- 2 Clip-On Transmitter/Mics, 1 Receiver
- 2 Lavalier Microphones + Windscreens
- Receiver Clips to Camera Shoe Mount



Teradek Ranger 4K 12G-SDI/HDMI Wireless TX/RX Set (V-Mount)

- Transmit Video up to 5000' Line-of-Sight
- HDMI and 12G-SDI Inputs and Outputs
- Transmit up to 4K60 HDR Video
- V-Mount Battery Mount on Each Unit



Teradek Node II LTE/4G/3G Multi-Mode Modem Module (USB Type-C Cable)

- For VidiU, Wave, Cube, Bond & Prism
- Works with Most 3G/4G/LTE Data Bands
- Twice the Performance of Other Modems
- Weather-Resistant Aluminum Chassis



Teradek Node Cellular 3G/4G/LTE USB Modem (SA/AUS)

- For 2-Person YouTube & Content Creation
- 2 Clip-On Transmitter/Mics, 1 Receiver
- 2 Lavalier Microphones + Windscreens
- Receiver Clips to Camera Shoe Mount

Accessories



E-Image Sling Grip Handle for Horizon One & Horizon Pro

- Provides a Comfortable Grip for Low-Mode
- Point of Contact for All Other Modes
- Adjustable on a Rosette Mount
- Shoe Mount, 1/4"-20 & 3/8"-16 Threads



E-Image EI-A07 Clamp with EI-A05 Stand Adapter

- Load Capacity: 6.6 lb
- Weight: 12.5 oz
- Clamps up to 1.6" Diameter
- 5/8" Male & Female Stand Adapters



E-Image EI-A44 HOT SHOE TO 1/4"-20 MALE POST ADAPTER

- Attaches to Camera Hot Shoe
- Converts Hot Shoe to 1/4"-20 Male Post
- With Locking Disk
- Lightweight, Durable Aluminum Material



E-Image 15mm Rod Mount Articulating Magic Arm (11")

- Articulating Arm with 15mm Rod Studs
- 1/4"-20 Mounting Platform with Lip
- 15mm Rod Port Adapter
- Use with 15mm Single Rods and Rod Ports



E-Image BSA-01 BOOM STAND HOLDER (work with tripod stands)

- Attaches on light stands & tripods
- Made from high-top aluminium alloy
- Provides stable support
- Durable, light weight and universal



E-Image GP1 Quick Release Plate

- For GH03/GH06/GH08/GH10 Heads
- 3/8"-16 and 1/4"-20 Screws + Guide Pin
- Use with S/N H1508XXX and Later
- Interchanges with PT-QRP Plate



E-Image Universal Middleweight Tripod Dolly with Locking Wheels

- Supports Dual-Spiked and Rubber Feet
- 132 lb Capacity
- Universal Sliding Mount on Each Leg
- Individually Locking Wheels



E-Image Quick Release Tripod Adapter (VCT-14 Type)

- For Select Sony & Panasonic Cameras
- Integrated Safety Catch
- Multiple 1/4"-20 & 3/8"-16 Holes

Accessories



E-Image Two-Tier Flat Mount Tilt Head

- Adjustable Mount for Small Camera
- Jointed Arms to Raise and Tilt Camera
- 360° Rotation, Flat-Bottom Mount
- Holds up to 5 lb at 45° Angle



E-Image 100mm Ball to Flat Base Adapter

- Mounts Flat Base Heads to 100mm Bowls
- 3/8"-16 Attachment Screw
- Tie-Down Wing Nut



E-Image VESA to 5/8" Baby Pin Adapter Female

- Supports up to 33 lb, 13-30" Monitor
- 75 x 75 & 100 x 100mm VESA Support
- Mounts onto 5/8" Baby Pin or C-Stand
- Tilt Adjustments



E-Image Pan Handle for E-Image Fluid Heads

- Telescoping Pan Bar
- Rubberized Handgrip
- Interlocking Rosette Mount
- 22.4" Max Length



E-Image F3 Tripod Rubber Feet Set for E-image Tripods

- Compatible with All E-Image Tripods
- Alternative to Metal Spikes



E-Image 75mm Bowl Attachment Knob for Select Fluid Heads

- Secures E-Image 75mm Bowl Head
- Loosens to Adjust Ball Head from Bottom
- Knurled Edges for Easy Grip
- Fits GH03, GH03F, GH05, GH06, GH08, GH10

Accessories



RØDE

Rode Micro Boompole 3-Section Telescopic Boompole

- For Video and Electronic News Gathering
- Three Sections Smoothly Extend to 6.3'
- Precision Balanced and Lightweight
- Anodized Aluminum Construction



RØDE

Rode Mini Boompole Compact Microphone for Remote Audio Capturing

- Measures 33 to 81" to (83-205.74cm)
- Compact and Lightweight



E-IMAGE

E-image ES120 E-Image 120CM Magic Slider (Fit for Magic Motor)

- lightweight carbon-fiber rails, and it comes with a weighted flywheel attaches to the end of the slider, providing a handle for smooth and precise hand-cranked slider, even at slow speeds.



E-IMAGE

E-image ES220 E-Image 220CM Extendable Slider (Fit for Magic Motor)

- It comes with a weighted flywheel attaches to the end of the slider, providing a handle for smooth and precise hand-cranked sliders. .



E-IMAGE

E-image Motor1 (function:time-lapse, stop-motion, trace record, loop)

- Works with ES-70 & ES-120 Sliders
- Mounts on Slider in Place of Flywheel
- Control via App for iOS & Android
- Slider Travel Control



E-IMAGE

E-image ED330 Portable Slider Dolly (Without Tripod)

- Collapsible System in a Custom Case
- 3.3 to 16.4' Track Length
- 110 lb Weight Capacity
- Supports Most Professional Tripods

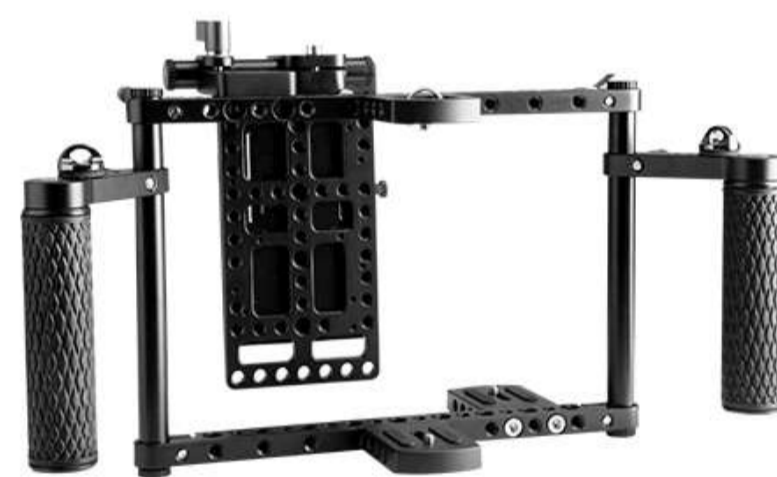

E-IMAGE

E-Image Q100 Director Monitor Cage with V-Lock Battery Plate

- TVU Router, the best 5g router for gigabit internet speed. Ensures 24/7 blazing fast, stable, and reliable internet anywhere in the world.



E-IMAGE

E-Image MK35 Moko Camera Adapter Plate

- universal rod system which may be used directly with a camera or on a DSLR rig with 15mm rods that are suitable for all on-camera accessories: matte boxes, follow focus systems, lens support



E-IMAGE

E-image BC16P Carbon Fiber Telescope boom with internal cable and bottom XLR base -6FT(1.8M)

- Telescoping Microphone Boompole
- 5-Section, Carbon Fiber Pole
- Extends from 34.5 to 138"
- 1/4"-20 and 3/8"-16 Mounts



E-IMAGE

E-image BA12P Aluminum Telescope boom with internal cable and bottom XLR base -12FT(3.5M)

- Telescoping Microphone Boompole
- 5-Section, Carbon Fiber Pole
- Extends from 34.5 to 138"
- 1/4"-20 and 3/8"-16 Mounts

Accessories



E-IMAGE

E-image EJ100LX-2 HUNTSMAN DAMPING SYSTEM JIB ARM (J100)-LUXURY(include Jib arm, long plate with bowl size, operation handle. With 7.5kg counterweight)

- Uses industry standard 3" ball/bowl system
- Mechanical real-time control of camera tilt via lever at jib fulcrum



E-IMAGE

E-image BK02 INTERNAL CABLE & XLR BASE KIT (for BC12,BC16)



E-IMAGE

E-image BK03S-- NEW BOOM POLE ACCESSORY WITH QUICK LOCKING & RELEASE



E-IMAGE

E-image BSA-01 BOOM STAND HOLDER(work with tripod ,stands)



E-IMAGE

E-Image EI-A11 EXTENDABLE WIRE CLAMP-MIDDLE SIZE

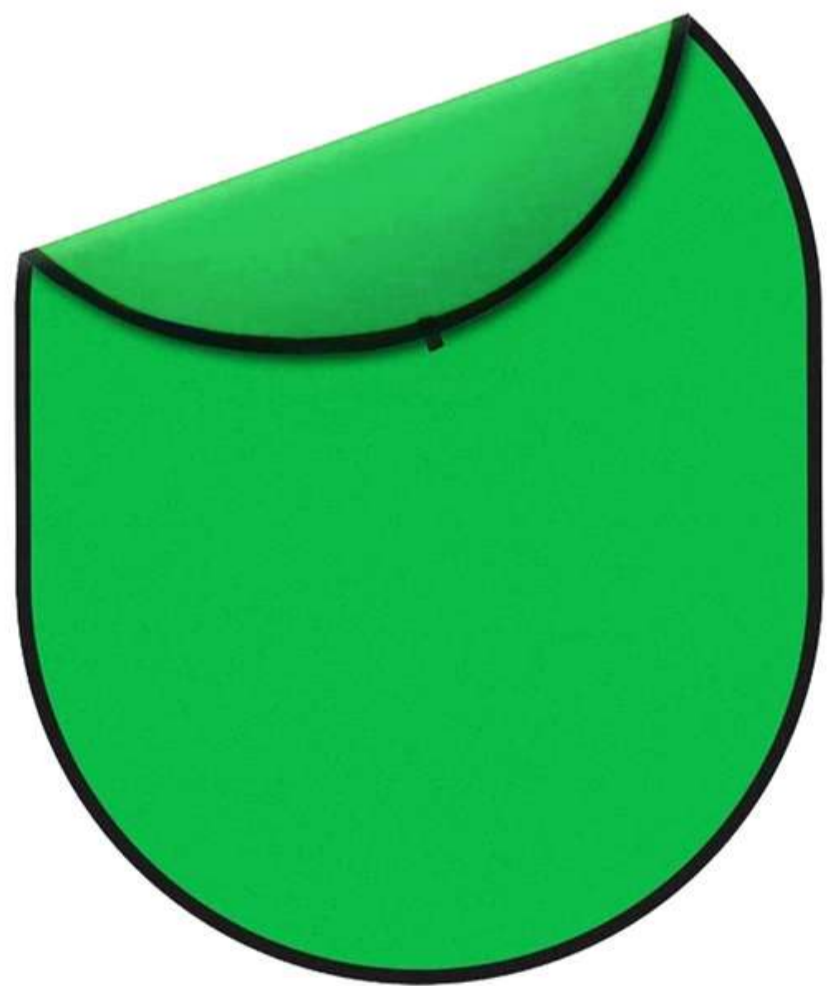

E-IMAGE

E-image RE2010 Collapsible Background panel-solid color (1.5*2M)



E-IMAGE

E-Image MB36 Solid Muslin Background(White/Black/Blue/ Green) 3*6M (No Stand)

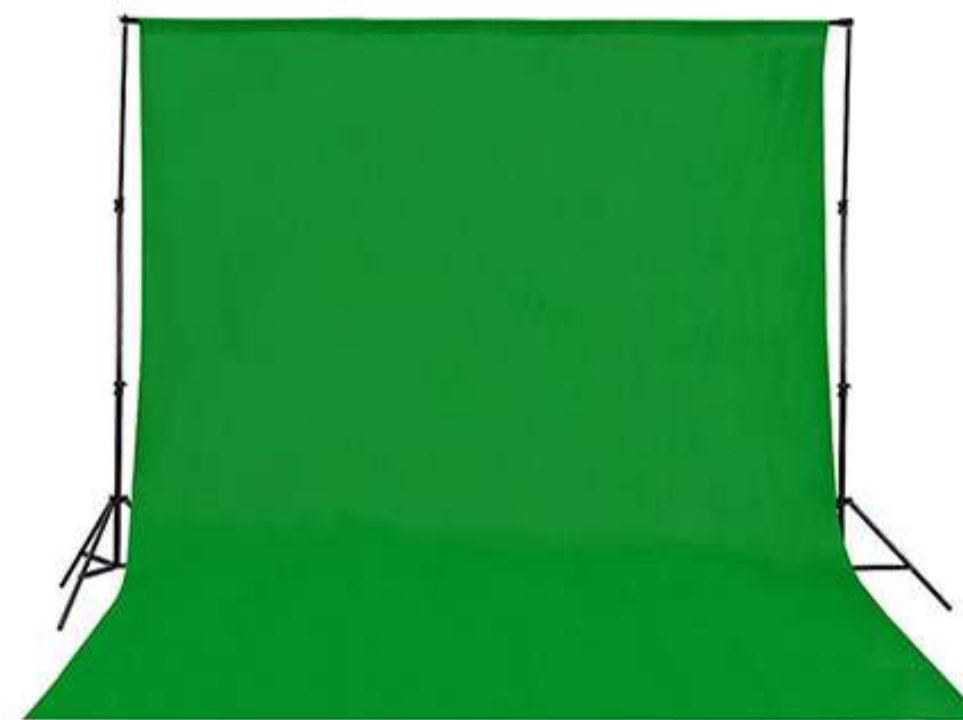

E-IMAGE

E-Image BS-901A Background stand kit with telescope boom- Width:3m



E-IMAGE

E-Image GS-200 Collapsible Photography Background - 200*200cm

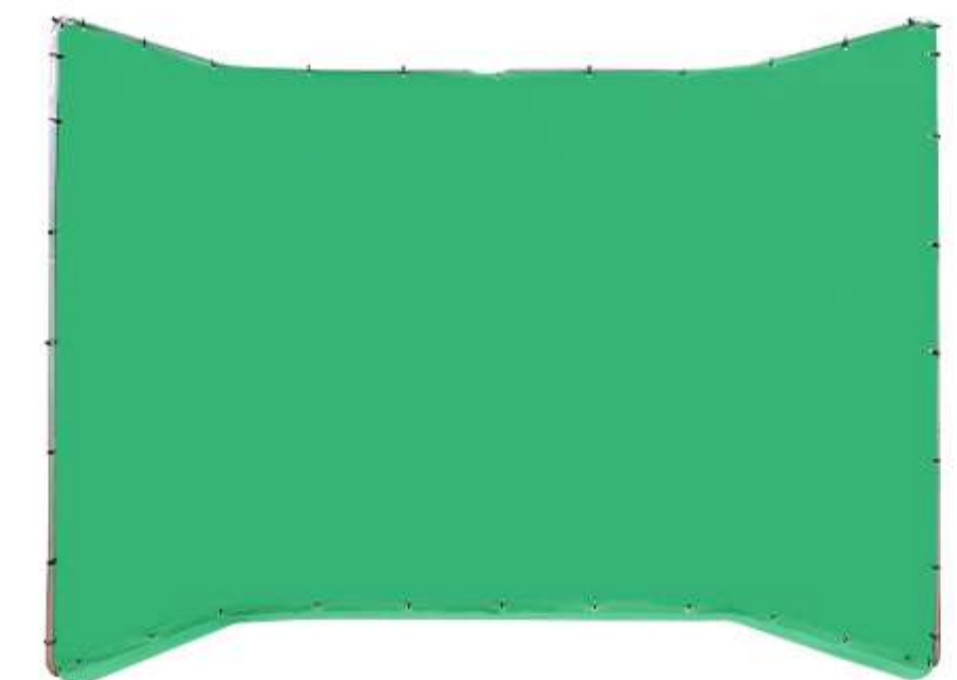

E-IMAGE

E-Image MB42--New Collapsible Background (W*H: 4.0*2.4m)

Accessories



 **E-IMAGE**

**E-Image MT-019 Male
3/8" thread with 5/8"
socket**



 **E-IMAGE**

**E-image S-001 1/4" D-
Ring camera screw
socket**



 **E-IMAGE**

**E-image S-005 1/4" to
3/8" screw adapter**



 **E-IMAGE**

**E-image S-007 1/4" to 3/8"
Converter Screw**



 **E-IMAGE**

**E-image S-009 1/4" male
to 3/8" female Screw
Adapter**



 **E-IMAGE**

**E-image S-011 1/4" male
to 3/8" male adapter
78mm**



 **E-IMAGE**

**E-image S-017 1/4"
female to 3/8" female
hex stud**



 **E-IMAGE**

**E-image S-020 1/4" screw
to hot shoe adapter**



 **E-IMAGE**

**E-image S-025 1/4" male to
3/8" male adapter Brass**



 **E-IMAGE**

**E-image S-034 1/4"
Female Thread & 5/8" Pin**

Accessories



E-image S-037 1-1/8"
Male Stud

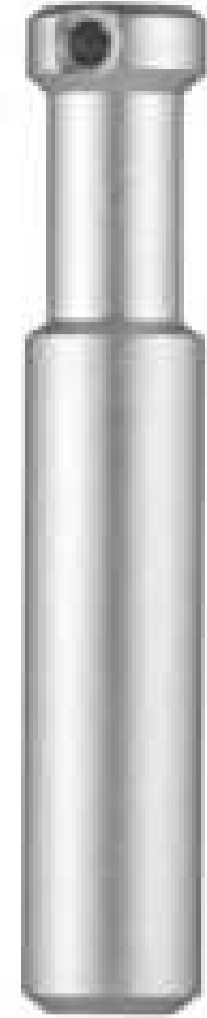

E-image S-042 1/4"Female
Thread to 5/8" Male Baby
Pin Aluminum 90mm



E-image C-001
Adjustable Gaffer Clamp
5/8" Pin & 5/8" Receiver



E-image C-006 Pipe
Clamp 1/2-13



E-image C-009 6"
Clamp



E-image TC-002 Boom
Clamp Tube
Diameter:8/16/19/25Mm



E-image TC-004 Grip Head
Tube
Diameter:8/16/19/25mm



E-image TC-005 Double
Grip Head Tube
Diameter:8/16/19/25mm



E-image GC-014 Coupler
Clamp $\varphi 40-\varphi 50\text{mm}$



E-image vESA to 5/8"
Baby Pin Adapter Female

Accessories



E-image MT-002 Twin 5/8"
Female 65mm



E-image MT-019 Male 3/8"
thread with 5/8" socket



E-image MT-009 Baby Drop Pin
5/8" Pin & 5/8" Receiver



E-image MT-015 Umbrella
Bracket with Adjustable Shoe



E-image AM-004 40" Extension
Arm Silver



E-image MT-021 Grip head



E-image RC-01 Reflector Clamp



E-image EI-A64 5/8" Baby
Swivel with Wall Plate

Video Mixers



Blackmagicdesign

Blackmagic Design ATEM Mini Pro HDMI Live Stream Switcher

- 4-Channel Live Stream HDMI Switcher
- Control up to Four BMPCC 6K/4K Cameras
- Live Tally, Stream and Record Status
- Record Button, Channel Preview Multiview



Roland

Roland V-1HD Portable 4 x HDMI Input Switcher

- 4 x HDMI Inputs with Frame Buffers
- Hardware or PC Control
- 12-Channel Digital Audio Mixer
- Manual T-Bar



AVMATRIX
PRO AUDIO VIDEO DEVICES

AVMATRIX PVS0615 Portable 6-Channel Video Switcher with 15.6" LCD Monitor

- Portable, All-in-One Video Switcher
- Built-In 15.6" LCD Monitor
- SD/HD/3G-SDI, HDMI, VGA/DVI, USB Inputs
- Auto-Detects Input Format



JVC

JVC ProHD Studio Sports Production/Streaming Studio

- 12-Input, 6-Channel HD Video
- NTSC/PAL, HD & NDI Signal Compatible
- HD-SDI, HDMI & IP Inputs
- Instant Replay with Slo-Mo & Playlists



datavideo

Datavideo TC-200 & CG-200 HD/SD Character Generator Kit

- TC-200 Overlay Box + CG-200 CG Software
- On-Screen Graphics and Titling Solution
- Supports Mixers with and Without DSK
- Minimal PC Processing Power Required



Broadcast Pix

Broadcast Pix MX 8 systems with 8 SDI inputs + 1 external key and 6 outputs, NewBlue NTX graphics

- 8 HD/SD SDI Inputs
- 1 Key Cut Input
- 6 HD/SD SDI Outputs
- 2 HD DVI Outputs
- 8 Channels of Clips & Graphics



streamstar

Streamstar IPX (8 input/6 replay channels) - 1080i

- 8 HD/SD SDI Inputs
- 1 Key Cut Input
- 6 HD/SD SDI Outputs
- 2 HD DVI Outputs
- 8 Channels of Clips & Graphics

KPG

Accessories



E-image S-048 Safety Cable 18" x 1.5mm



E-image S-054 Sand Bag



E-image F-002 Foamcore ForkMale 1/4" & 3/8" Thread



E-image MS-007 Multiple Mount Light Stand
Length:50.5cm, 30x30mm



E-image WP-005 Scissor Mount for
Drop Ceiling 5/8" Pin



E-image AM-009 3 Section Articulated
Arm 5/8" Stud with 1/4"-20 Female Thread
& 5/8 Stud with 3/8"-16 Female Thread



TVU First-Class Remote Production Solution for Live Multi-Camera Video Over IP

- With just an encoder and a decoder, TVU RPS aggregates up to 12 internet connections to provide high-speed, perfectly synchronized transmissions from multiple remote sources to your current studio.



TVU One 4k Video Transmitter & Live Streaming Encoder

- Deliver pristine 4K HDR quality and sub-second latency video return, with transmission speeds over 100Mbps, and real-time live streaming H265 encoding.



TVU Channel - Go beyond payout.

- The 24/7 Channel solution created with the world's biggest broadcasters available for everyone. Build your own Free Ad-Supported TV channel now.



TVU Cloud-based Live Streaming & Video Production Platform

- TVU Producer is a cloud-based live streaming solution for live video production and live broadcasts



TVU Live Streaming App For Mobile Video Broadcasting

- TVU Anywhere is a mobile live-streaming app delivering high-quality live transmission for video broadcasting in remote locations.



TVU Cloud Collaboration Solution For Video Conferences & Events

- TVU Partyline is a broadcast quality cloud collaboration solution enabling live interaction in real-time for crew members, talent, contributors, and viewers.



TVU Fastest 5G Router With Gigabit Internet For Professional Broadcasts

- TVU Router, the best 5g router for gigabit internet speed. Ensures 24/7 blazing fast, stable, and reliable internet anywhere in the world.



Computers Catalogue

Product Overview

KPG

logitech

Headset, microphone, mouse, keyboard and track pad

DELL™

Deskstop, laptops, monitors adaptors and accessories

acer

Laptops and desktop and accessories

hp

Laptops, deskstops, printers

brother

Printers, cartridges and printer accessories



Deskstop, laptops, adaptors, chargers, batteries, mouse, keyboard and accessories

Lenovo™

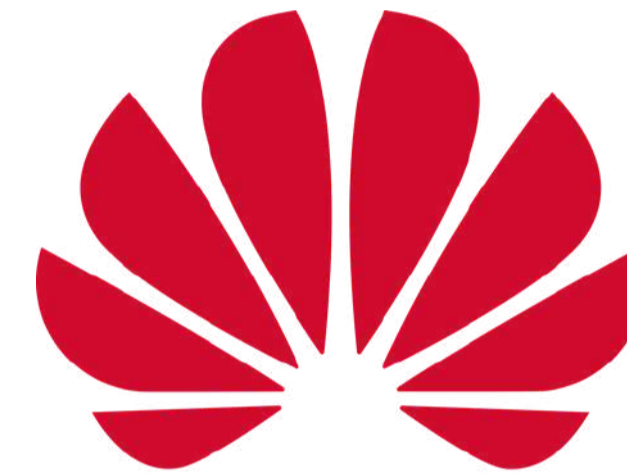

HUAWEI

Laptops, desktops, adaptors, charger and accessories

Doggles, routers, access points and switches

FUJITSU

Printers, cartridges and printer accessories

MECER

Deskstop, laptops, monitors adaptors and accessories

PHILIPS

Monitors

ASUS

Deskstop, laptops, adaptors and accessories

Laptops



HP 250 G9 Celeron N4500 4GB 500GB



**HP 450 G8 Ci5-1135G7 4GB 256GB 15.6
HD SVA**



**HP 250 G8 Intel Core I5-1135G7 8GB 256GB
W11 Pro64**



**Lenovo V15-ITL i3-1115G4 4GB RAM 256GB SSD
Integrated Graphics 15.6in FHD Win11 Pro64 Wi-
Fi BT Cam 2 Cell 1 Year Carry-in Warranty Black**



**Lenovo V15-ITL i5-1135G7 8GB 512GB SSD
Integrated Graphics 15.6in FHD Win11
Pro64 BT Cam 2 Cell 1Yr Carry-in
Warranty**



**HP 250 G8 Celeron N4020 4GB 500GB
W11Home**



ABOUT KPG TECHNOLOGIES

We are proud of our 27-year heritage of supplying, maintaining and supporting the creative industry with a vast array of products. We believe in growing the types of products and options we offer that add value to our complete basket of solutions. . We pride ourselves on our loyal longstanding customer relationships which are split over various business sectors. We have a growing and diverse customer base of clients and have developed unique routes to market that caters for every customer type. We focus on providing unique and bespoke solutions that exceed our customer's expectations irrespective of size or value of spend.



CONTACT US



021 424 7501
011 326 3478



6 Dorman St, Gardens,
Cape Town, 8001

372 Oak Avenue, Block
C, Randburg, Johannesburg



www.kpg.co.za
salesjhb@kpg.co.za