

Anleitung / Manual

JONTE OAK

DE + US

P-01-040

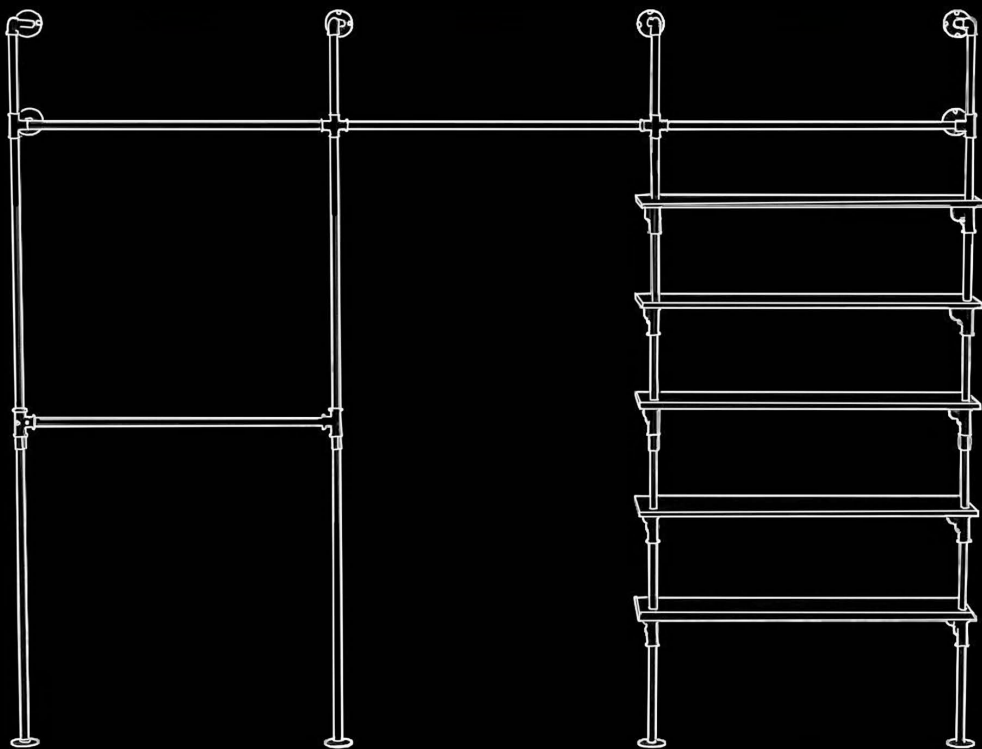

HOW-TO
VIDEO

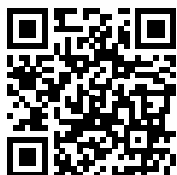

pamo.



! Warnhinweise beachten!
Observe warnings!



2 Personen /
2 persons



Werkzeug /
Tools



Unterlage verwenden /
Use Underlay

Lieferumfang / Scope of delivery



A × 10



F × 4



J × 24



I × 24



4mm



G × 10



B × 4



R × 5



O × 12



E × 16



C × 2



D × 2



x20 × 10



x25 × 10



x93 × 12

Bitte prüfen Sie alle Teile auf Transportschäden oder Macken.

Sollten Sie Transportschäden entdecken ersetzen wir sofort die entsprechende Teile.

Please check the parts for transport damage or scratches.

If you find any damage, contact us and we will replace the defective parts.

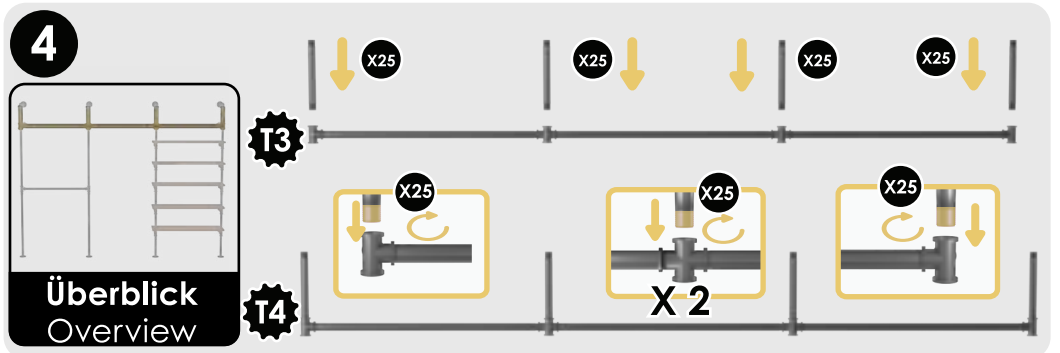
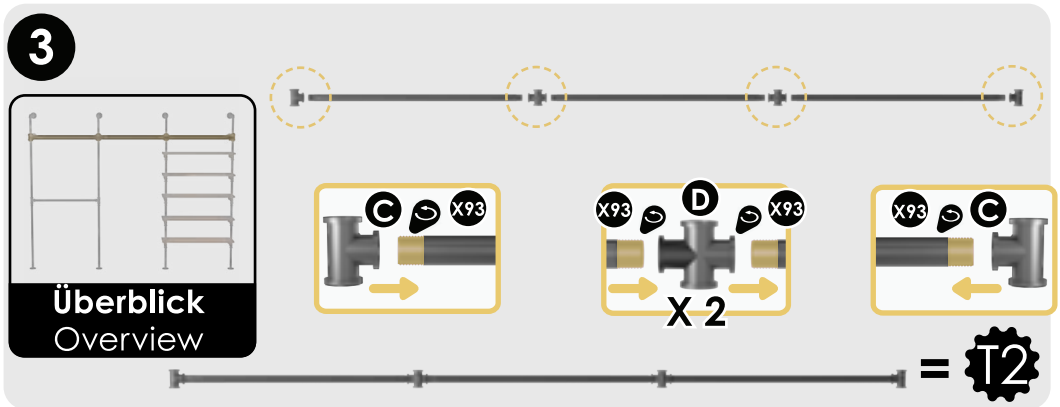
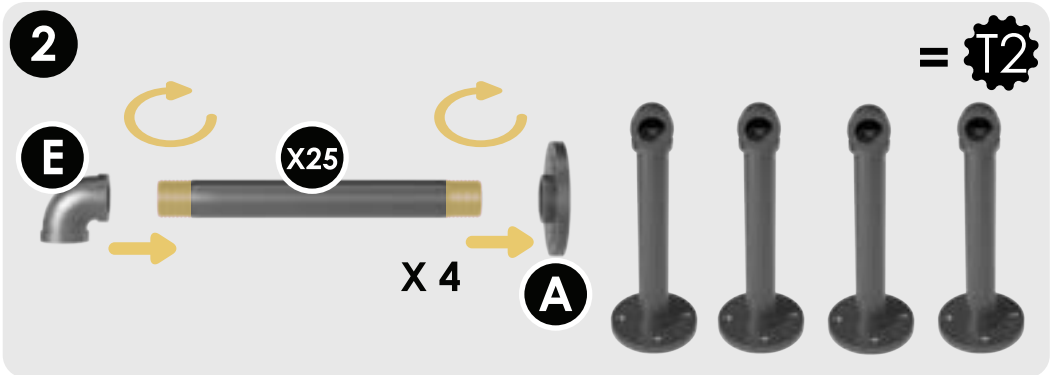
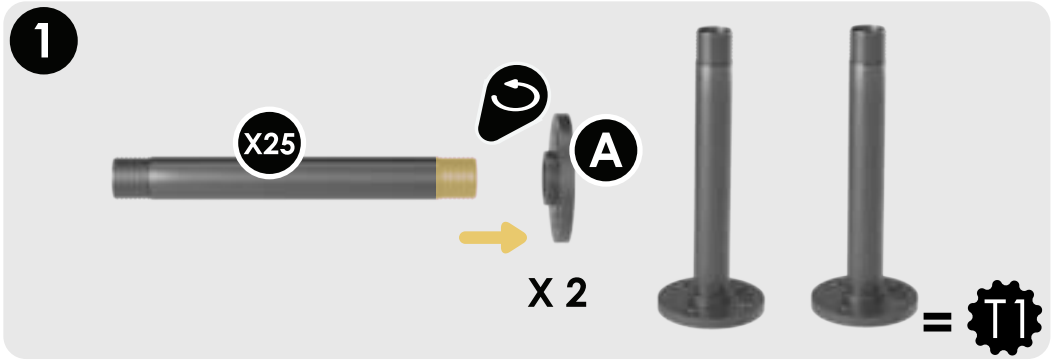

5

T2

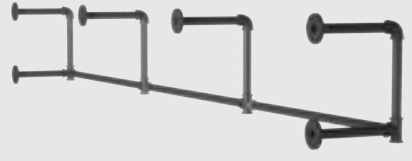
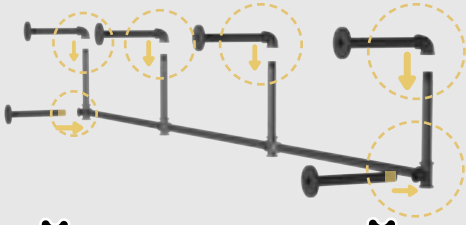
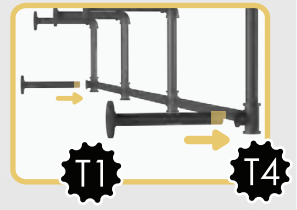
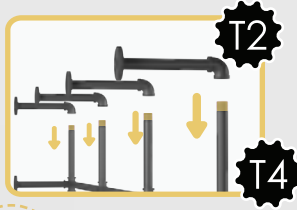

= T5

6

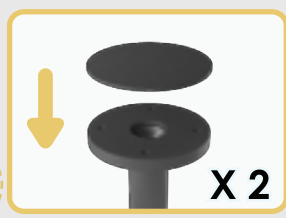
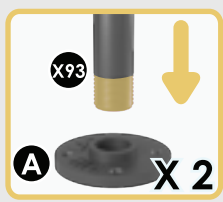
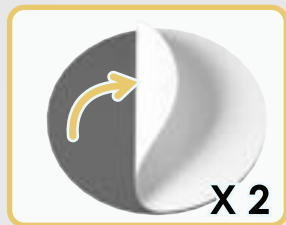
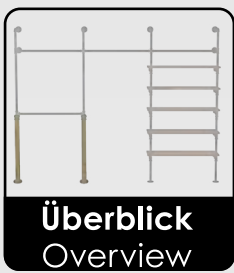

= B1

7

F

X93

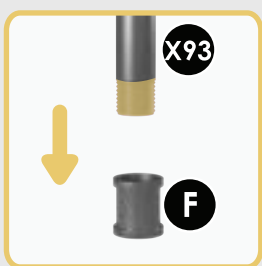
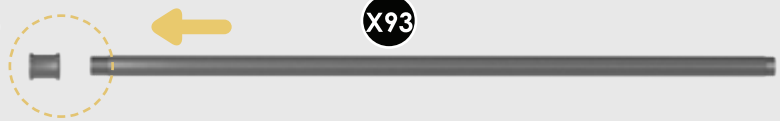

X 2

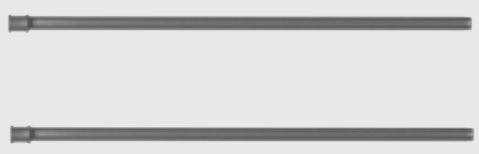

= B2

8

B2

B1

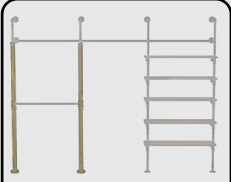

Überblick
Overview

B2



B1

X 2

= B3

9

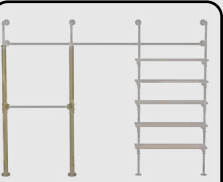

Überblick
Overview

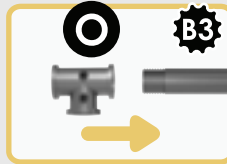

X 2

= L1 L2

10

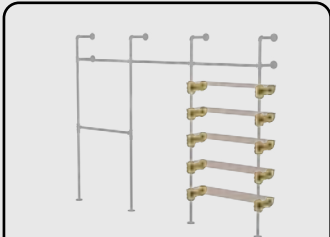

Überblick
Overview

E

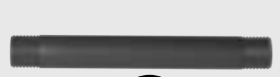

X20



G

X 10



O



= WS

11

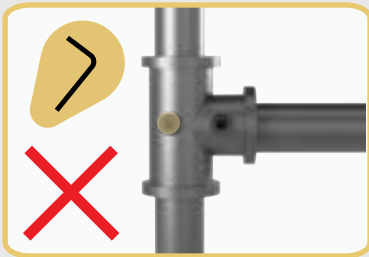
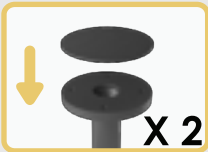
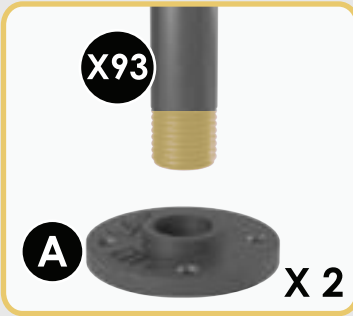
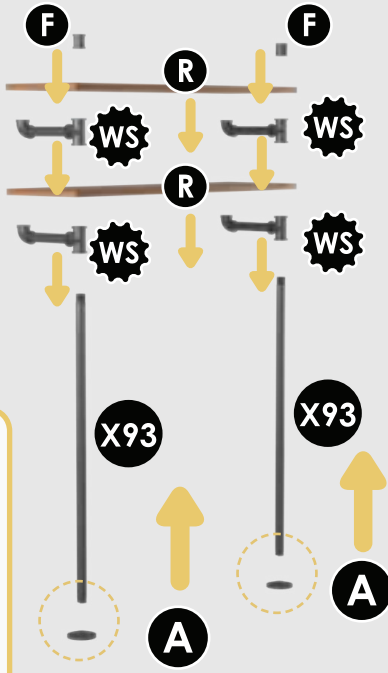
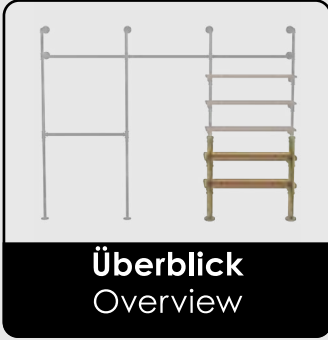

Stellen Sie sicher, die Schraube an der O-Rohrverschraubung **NICHT** festzuziehen, um Schritt 13 ausführen zu können.

Make sure "NOT" to tighten the screw on the O fitting to be able to execute step 13



12

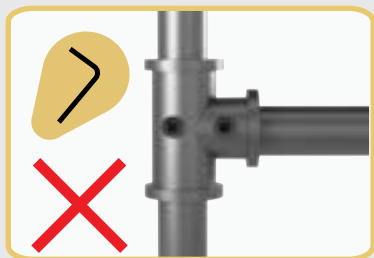
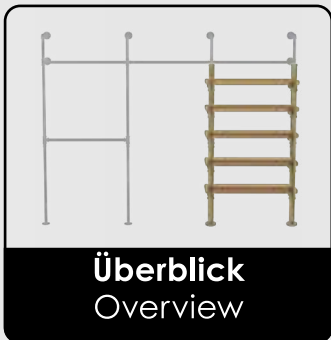

Stellen Sie sicher, die Schraube an der O-Rohrverschraubung NICHT festzuziehen, um Schritt 13 ausführen zu können.

Make sure "NOT" to tighten the screw on the O fitting to be able to execute step 13

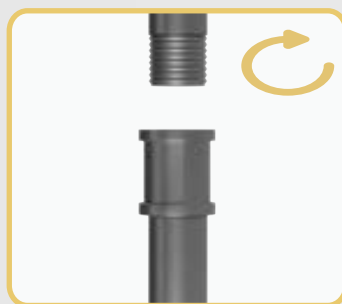
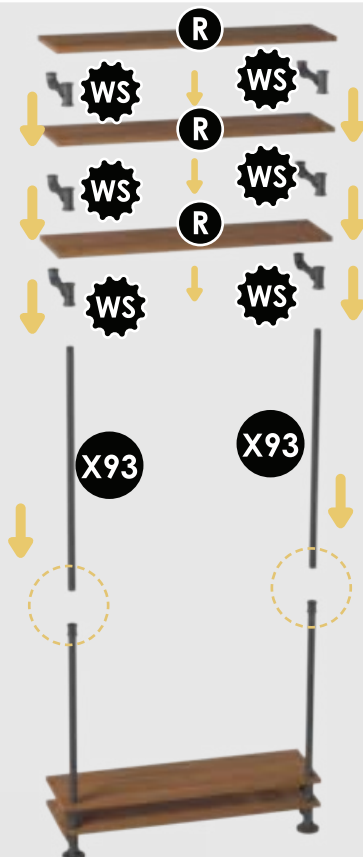

13

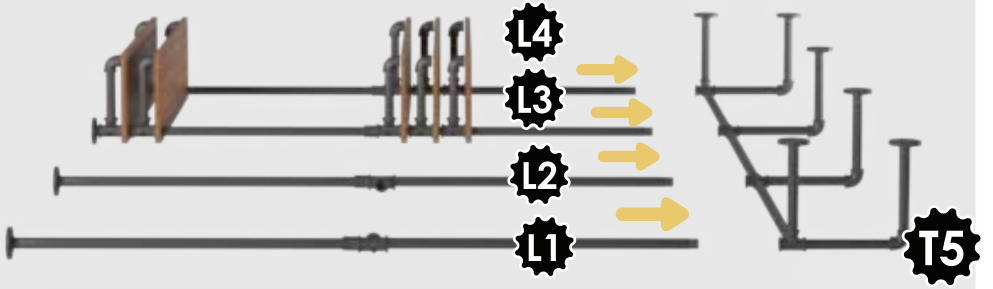

14

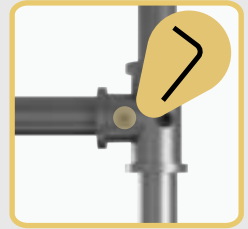
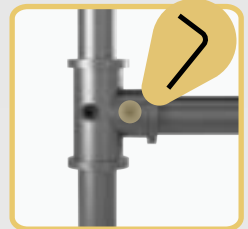
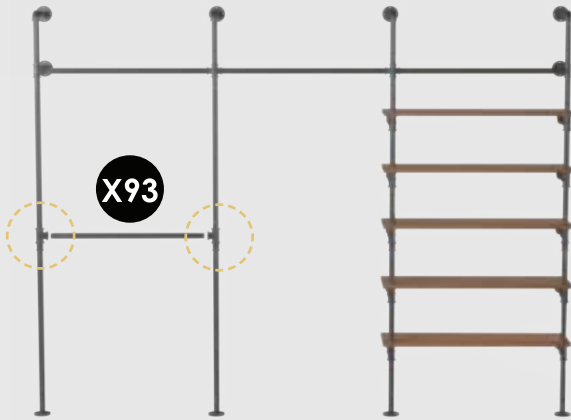

15

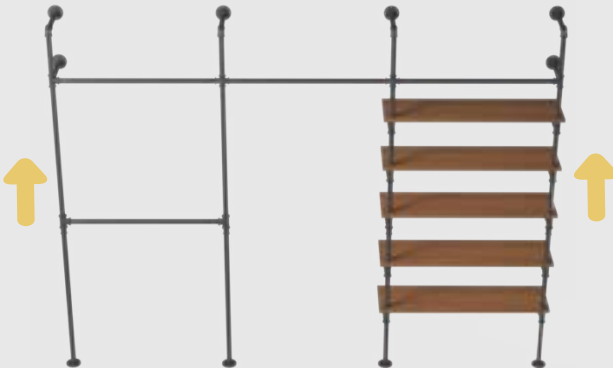

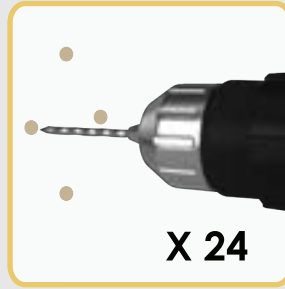
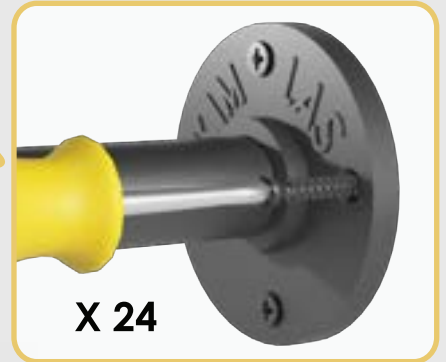
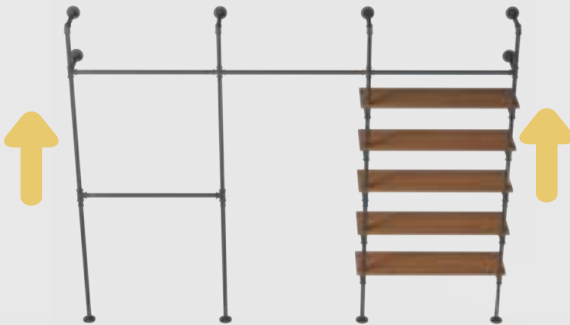
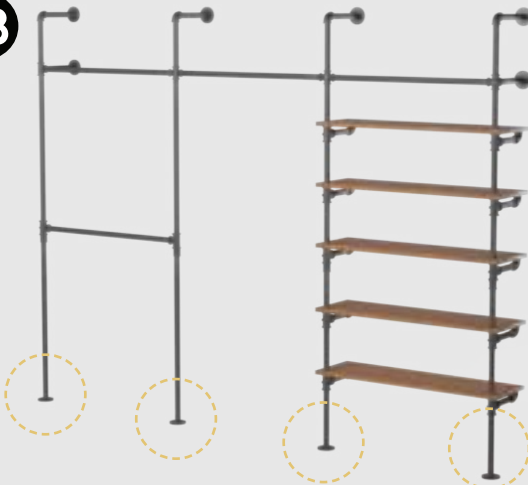
16**17****18**

Zum Schluss Stange "A fitting" ein wenig herausdrehen und gegen den Boden zu verspannen. Damit erhält man eine zusätzliche Stabilität und gleicht Unebenheiten im Boden aus./

Finally, unscrew rod "A fitting" a little and brace it against the floor. This provides additional stability and compensates for unevenness in the floor.

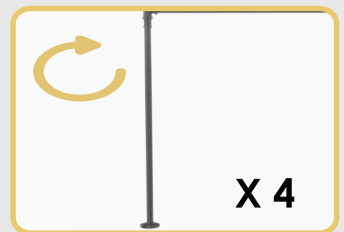

19

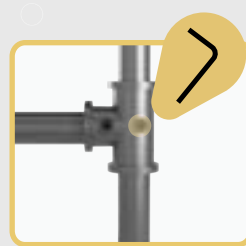
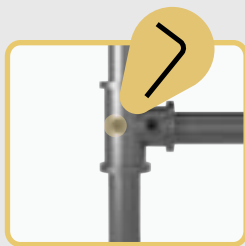
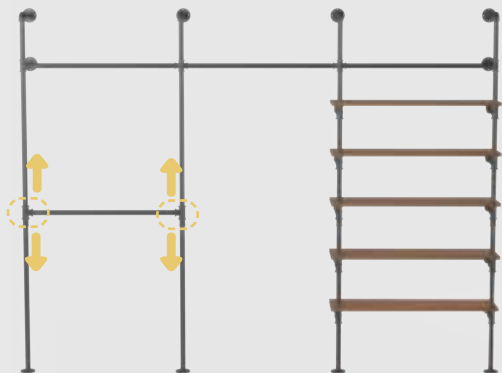

An die gewünschte Höhe anpassen
Adjust to preferred elevation

20

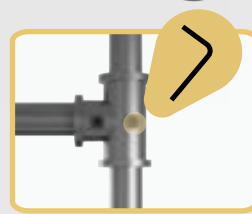
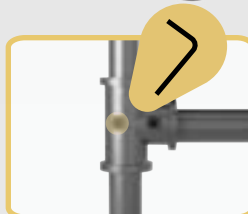
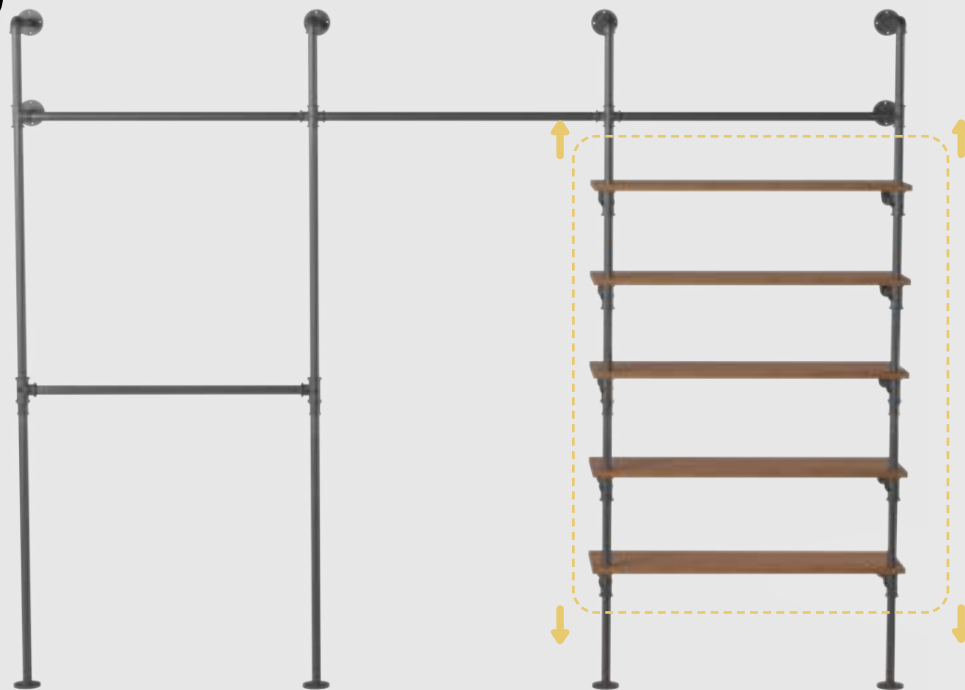

An die gewünschte Höhe anpassen
Adjust to preferred elevation

X 5

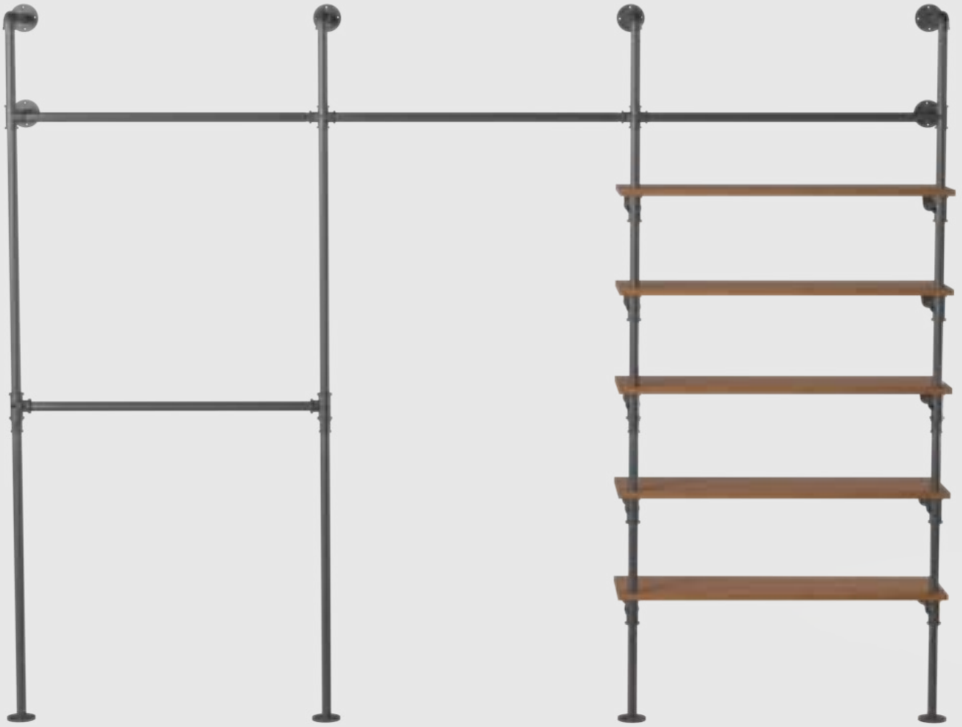

Wichtige Hinweise

Important notes

Nur zur Nutzung als Kleiderstange gedacht.

Intended only for use as a clothes rail.

**max. Belastung pro Boden 20 kg, max. Belastung pro Querstange 30kg.
Nur an tragfähigen Wänden montieren ggf. prüfen.**

max. load per shelf 20 kg, max. load per horizontal pipe 30 kg.

Only mount on load-bearing walls, check if necessary

**Bei unsachgemäßer Nutzung übernimmt SaleLab GmbH keine Haftung
oder sonstige Verantwortung für Sach- oder Personenschäden entstehen.**

*SaleLab GmbH assumes no liability or other responsibility for property
damage or personal injury resulting from improper use.*

**Viel Spaß mit deinem
pamo.-Produkt!
Enjoy your pamo.-product!**

**Kontakt / contact
Wir helfen Dir gerne:
We are happy to help you:**

EU

 support@pamo-design.de
 www.pamo-design.de

US

 support@pamo-design.com
 www.pamo-design.com

pamo.

Europe

SaleLab GmbH | Haydnstraße 28
88284 Wolpertswende | DE

USA

SaleLab Inc | 444 Brickell Avenue
Suite 700 | Miami, FL 33131 | USA