

# Anleitung / Manual

## ALVA OAK

DE + US

P-01-035

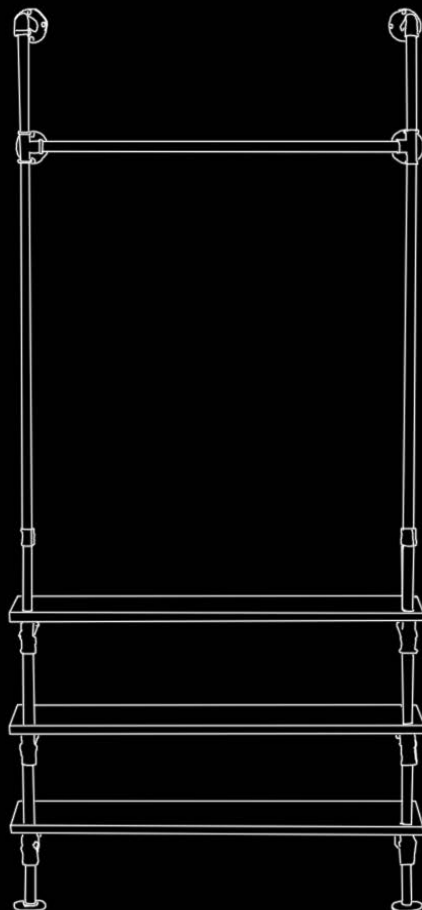

HOW-TO  
VIDEO

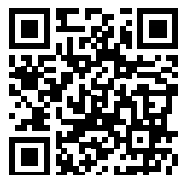

pamo.



**! Warnhinweise beachten!**  
Observe warnings!



**2 Personen /**  
2 persons

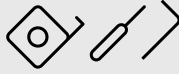

**Werkzeug /**  
Tools



**Unterlage verwenden /**  
Use Underlay

**Lieferumfang /** Scope of delivery



**A** × 6



**F** × 2



**J** × 16



**I** × 16



4mm



**G** × 6



**B** × 2



**R** × 3



**O** × 6



**E** × 8



**C** × 2



**x20** × 6



**x25** × 6



**x93** × 5

**Bitte prüfen Sie alle Teile auf Transportschäden oder Macken.  
Sollten Sie Transportschäden entdecken ersetzen wir sofort die entsprechende Teile.**

Please check the parts for transport damage or scratches.  
If you find any damage, contact us and we will replace the defective parts.

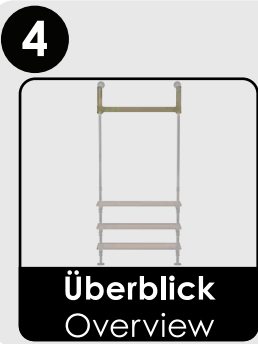
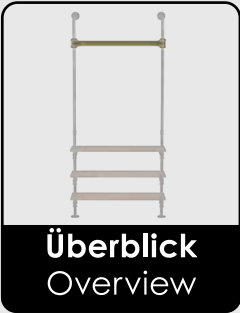
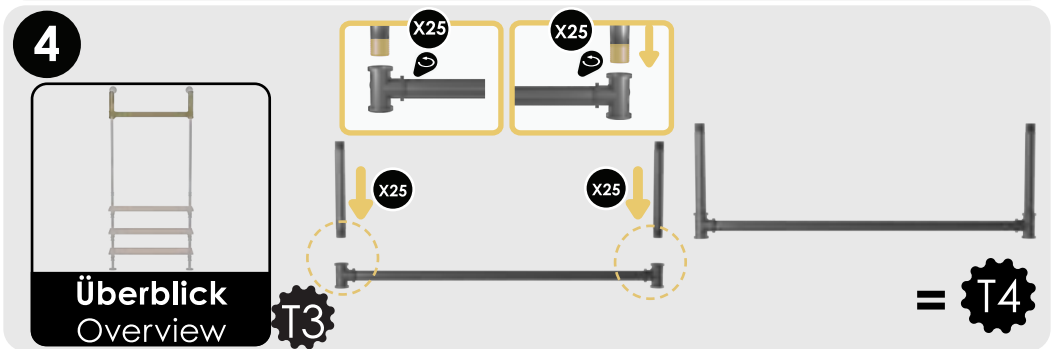
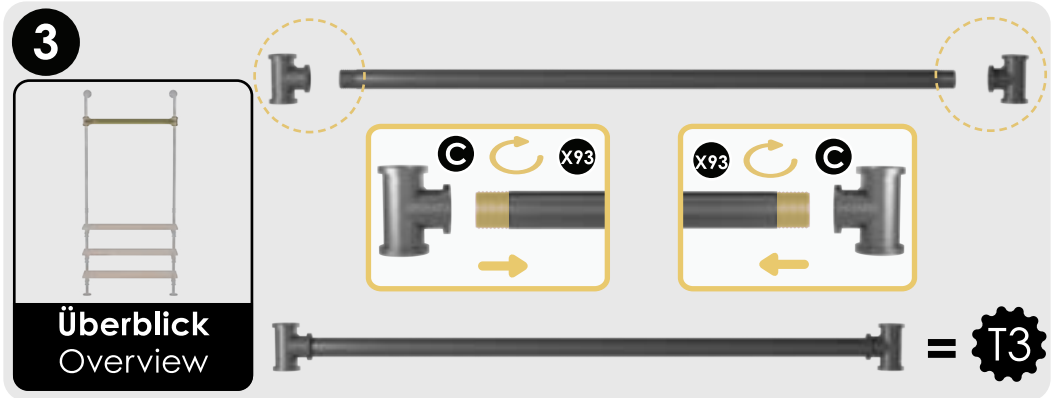
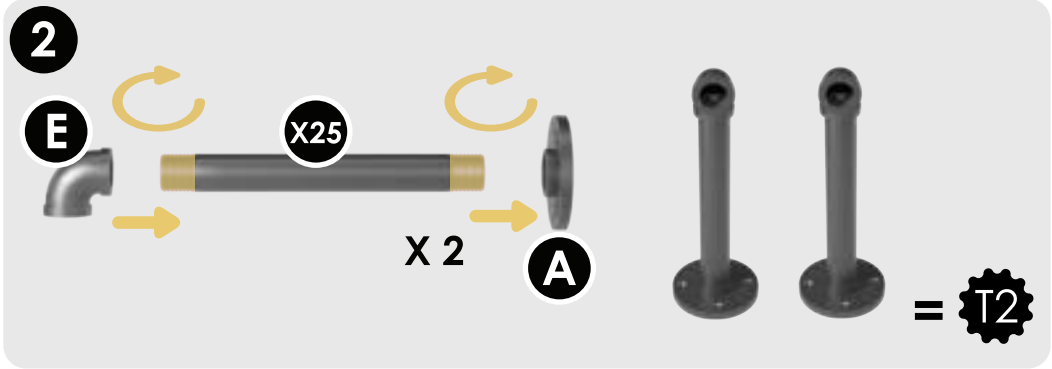
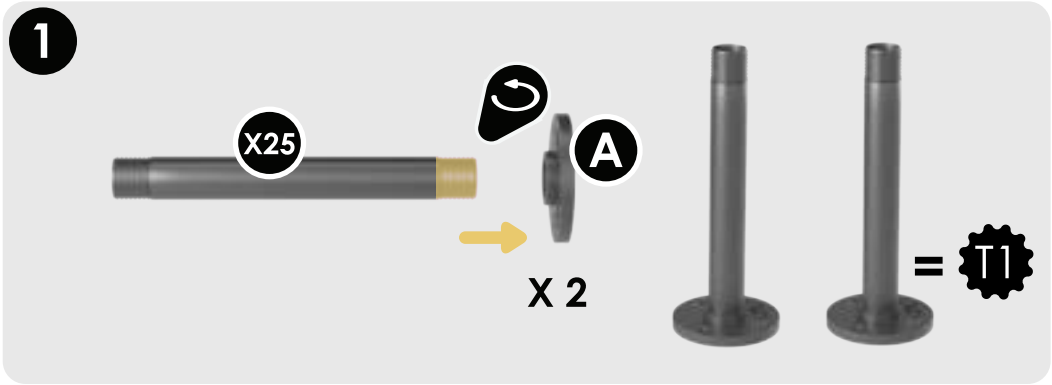

5

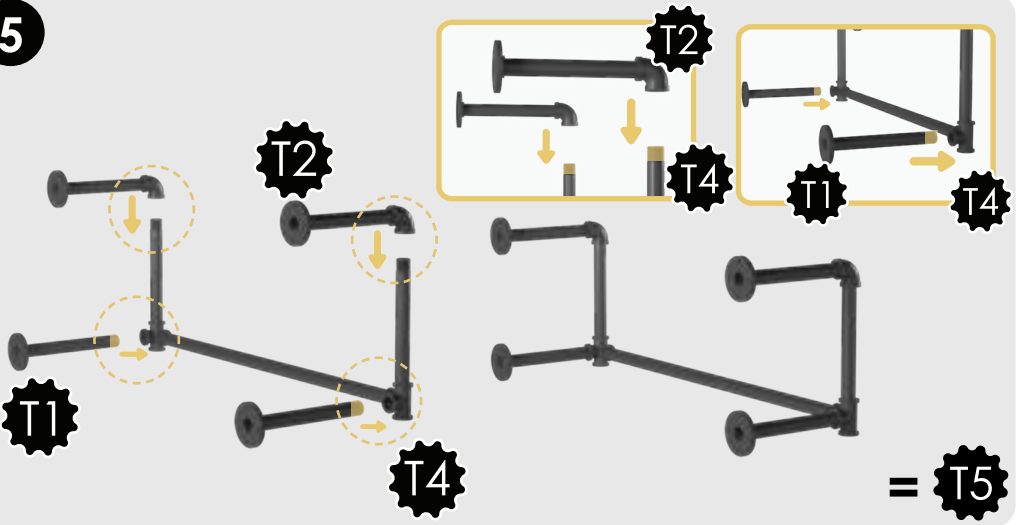

= T5

6

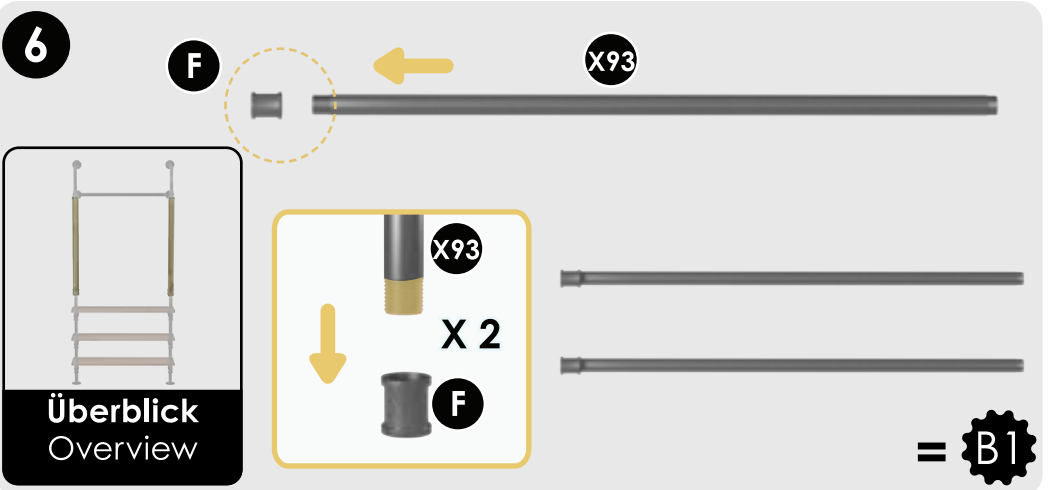

= B1

7

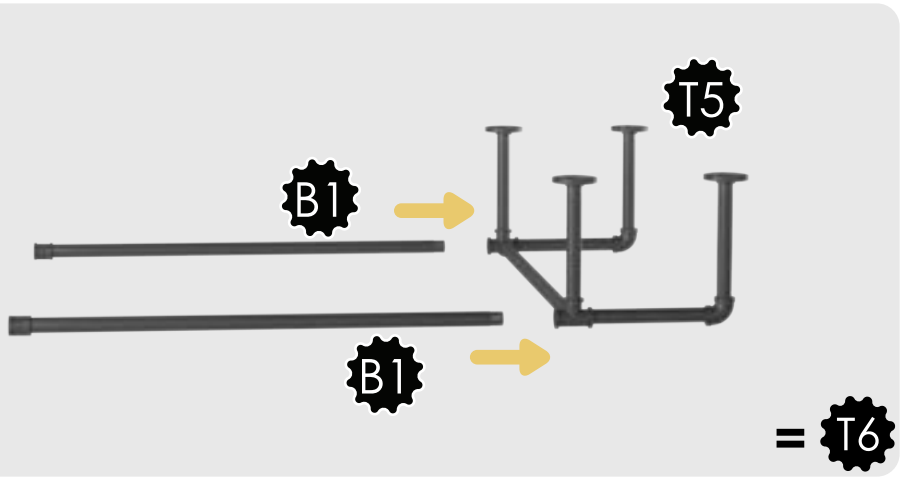

= T6

8

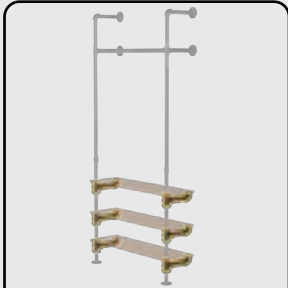

Überblick  
Overview

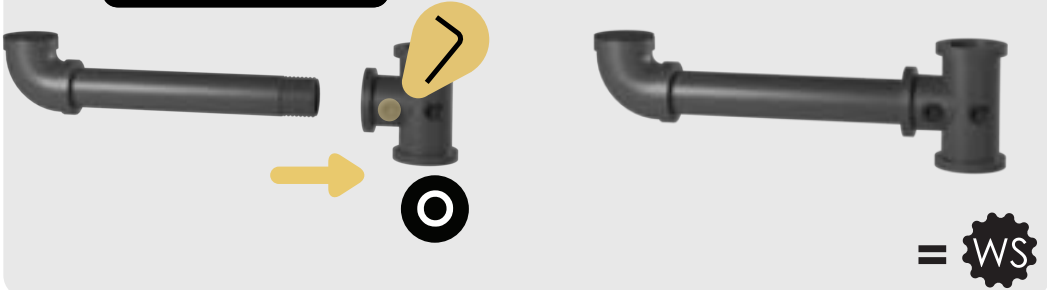
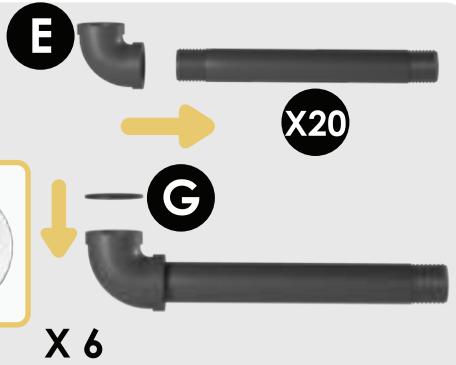

9

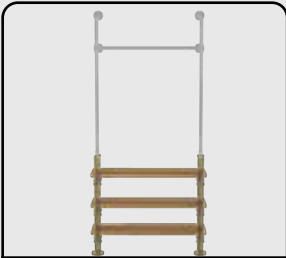

Überblick  
Overview

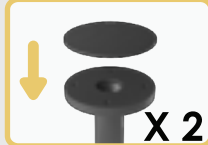
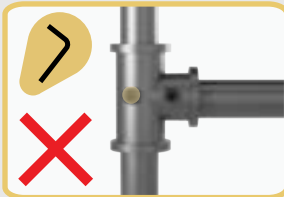
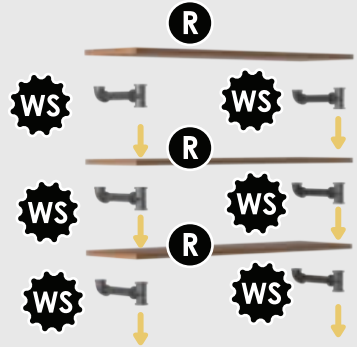
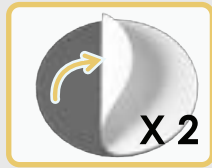

Stellen Sie sicher, die Schraube an der O-Rohrverschraubung NICHT festzuziehen, um Schritt 10 ausführen zu können.

Make sure "NOT" to tighten the screw on the O fitting to be able to execute step 10

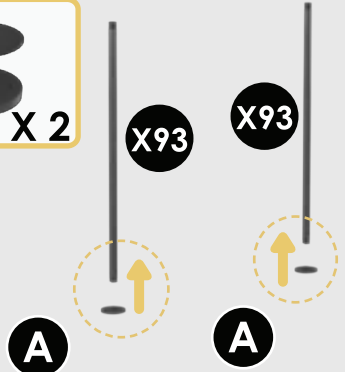

10

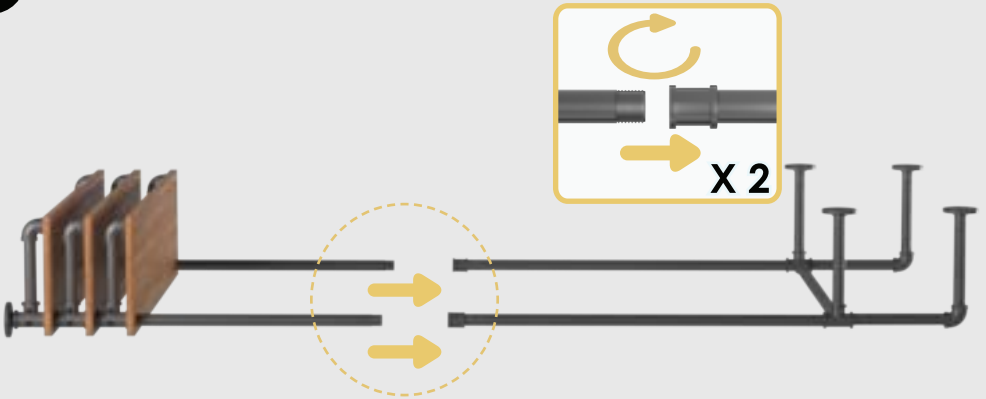

11

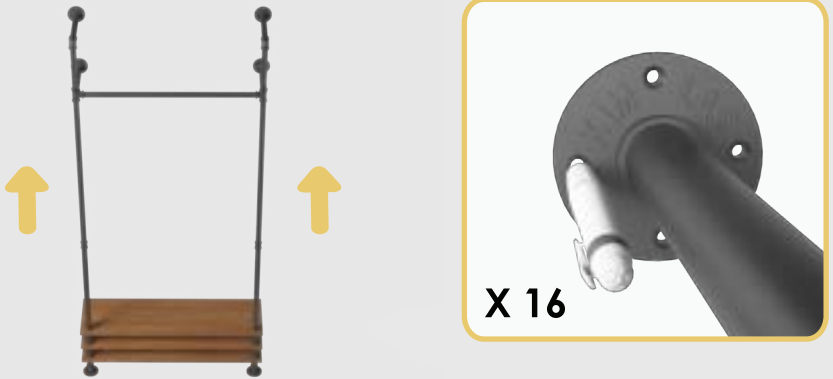

12

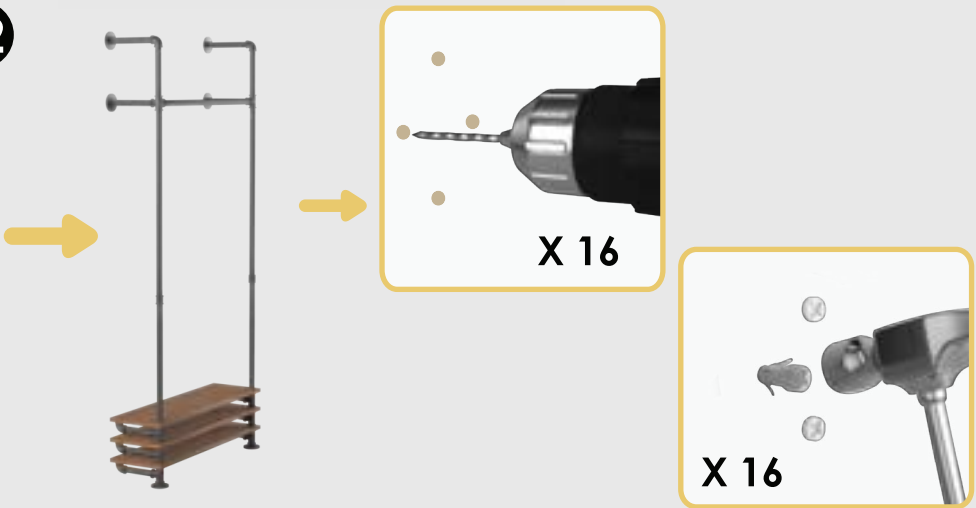

13

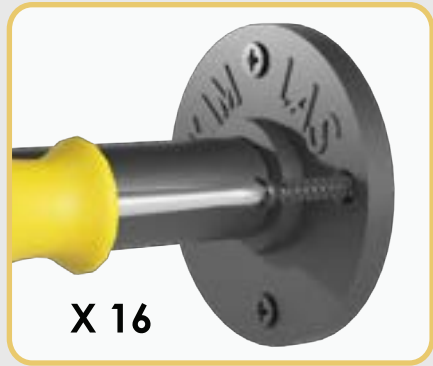
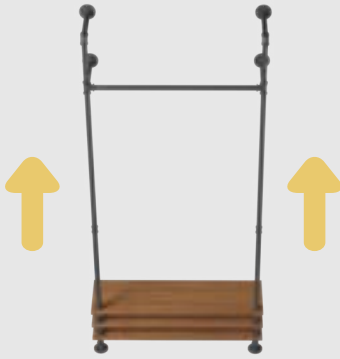

X 16

14

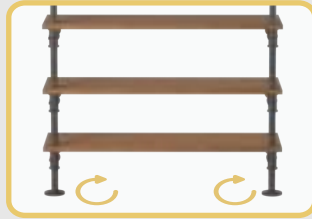
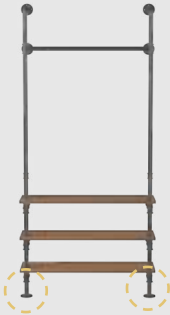

Zum Schluss Stange "A fitting" ein wenig herausdrehen und gegen den Boden zu verspannen. Damit erhält man eine zusätzliche Stabilität und gleicht Unebenheiten im Boden aus./

Finally, unscrew rod "A fitting" a little and brace it against the floor. This provides additional stability and compensates for unevenness in the floor.

15

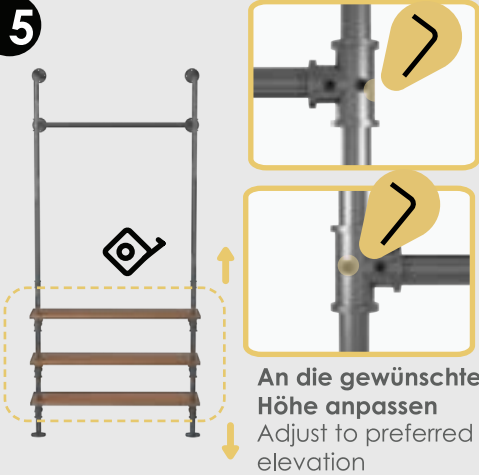

An die gewünschte Höhe anpassen  
Adjust to preferred elevation

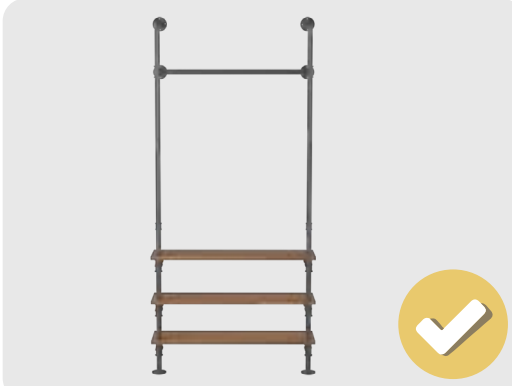

**Wichtige Hinweise**  
*Important notes*

**Nur zur Nutzung als Kleiderstange gedacht.**

*Intended only for use as a clothes rail.*

**max. Belastung pro Boden 20 kg, max. Belastung pro Querstange 30kg. Nur an tragfähigen Wänden montieren ggf. prüfen.**

*max. load per shelf 20 kg, max. load per horizontal pipe 30 kg. Only mount on load-bearing walls, check if necessary*

**Bei unsachgemäßer Nutzung übernimmt SaleLab GmbH keine Haftung oder sonstige Verantwortung für Sach- oder Personenschäden.**

*SaleLab GmbH assumes no liability or other responsibility for property damage or personal injury resulting from improper use.*

**Viel Spaß mit deinem  
pamo.-Produkt!  
Enjoy your pamo.-product!**

**Kontakt / contact  
Wir helfen Dir gerne:  
We are happy to help you:**

**EU**

 [support@pamo-design.de](mailto:support@pamo-design.de)  
 [www.pamo-design.de](http://www.pamo-design.de)

**US**

 [support@pamo-design.com](mailto:support@pamo-design.com)  
 [www.pamo-design.com](http://www.pamo-design.com)

**pamo.**

**Europe**

SaleLab GmbH | Haydnstraße 28  
88284 Wolpertswende | DE

**USA**

SaleLab Inc | 444 Brickell Avenue  
Suite 700 | Miami, FL 33131 | USA