

FISHER & PAYKEL

HEAT PUMP CLOTHES DRYER

DH8060P model

INSTALLATION GUIDE / USER GUIDE

NZ AU

CONTENTS

Introduction	3
Safety and warnings	4
Installation instructions	8
Control panel	13
Drying cycles	15
Sorting and loading	16
Getting started quickly	19
Customising drying cycle	20
Caring for your dryer	22
Before you call for service	25
Fault codes	26
Troubleshooting	27
Manufacturer's warranty	33
Customer care	35

IMPORTANT!

SAVE THESE INSTRUCTIONS

The models shown in this User guide may not be available in all markets and are subject to change at any time. For current details about model and specification availability in your country, go to our website fisherpaykel.com or contact your local Fisher & Paykel dealer.

Registration

Register your product with us so we can provide you with the best service possible.

To register your product visit our website: fisherpaykel.com

INTRODUCTION

Welcome to your new heat pump clothes dryer

Thank you for purchasing a Fisher & Paykel clothes dryer. We are proud of this dryer and trust it will serve you well for many years.

At Fisher & Paykel we aim to provide innovative products that are simple to use, ergonomic, energy efficient and kind to the environment. Thousands of tonnes of laundry and 80 years of experience have been programmed into your dryer to help give you the best possible performance.

Your dryer has the benefit of heat pump technology, which allows clothes to be dried at lower temperatures, improving clothes care while saving energy. This dryer also has the advantage of not needing to be vented outside, instead it condenses the moisture from the clothes and collects this in a water tank, or for convenience, can pump it directly into a drain.

Your new dryer gives you the convenience of tumble drying and your clothes the advantage of not being subjected to the harsh over drying effects of the sun. Your clothes will feel softer, retain their shape and require less ironing. This dryer has been specifically designed to complement our front loading Fisher & Paykel washers.

Your heat pump dryer has numerous cycles and options so you can perform every drying task (including flat drying) with ease, allowing you to spend less time in the laundry. With the ability to automatically sense when your clothes are dry, your dryer is more efficient, making it kinder on your wallet and the environment.

Please take the time to read these instructions carefully before you begin using your dryer. Following the advice in this user guide will ensure you get the performance you expect from your dryer and that you get the best possible results. Keep these instructions for future reference and pass them on with your dryer, if it changes hands.

We hope you enjoy your new dryer. We have certainly enjoyed designing it for you.

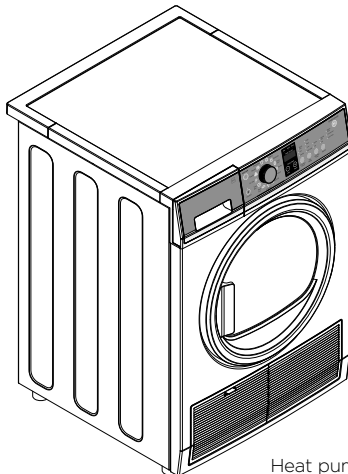

Heat pump clothes dryer

SAFETY AND WARNINGS

Meaning of symbols on the dryer



Warning: Risk of fire/Flammable materials



Read the instructions

WARNING!



Fire Hazard

- Only dry fabrics that have been washed with water.
- Do not use heat to dry articles containing foam rubber or similarly textured rubber-like materials, dry on 'Air Dry'.
- Never stop a tumble clothes dryer before the end of the drying cycle unless all items are removed and spread out in order to dissipate the heat.
- A clothes dryer produces combustible lint; the lint filter must be cleaned before each drying cycle.
- Failure to follow the warnings outlined in these user instructions can cause a fire hazard.
- Failure to follow these instructions can result in death or personal injury.

IMPORTANT SAFETY INSTRUCTIONS

WARNING!

- The appliance must not be supplied through an external switching device, such as a timer, or connected to a circuit that is regularly switched on and off by a utility.
- We do not recommend the use of extension cords or portable electrical outlet devices for safety reasons.
- Do not touch or operate the machine with wet hands or with bare-feet.
- A damaged power cord must be replaced by a Fisher & Paykel trained and supported service technician, its service agent or similarly qualified persons in order to avoid a hazard. The appliance must not be operated until it is repaired, as there is risk of electric shock.
- Do not operate this machine if it has been damaged during transport. Contact your Fisher & Paykel dealer or Fisher & Paykel trained and supported service technician.

SAFETY AND WARNINGS

When using this appliance always exercise basic safety precautions including the following:

Dryer use

- This dryer has been designed for domestic use only, not for commercial applications, such as massage/beauty clinics where there may be increased lint accumulation or flammable materials in the atmosphere or load.
- The tumble dryer is intended only for drying textile material washed in water.
- Undergarments that contain metal reinforcements should not be placed in the dryer. Damage to the dryer can result if the metal reinforcements come loose during drying. If you wish to dry these items use a drying rack or place in a garment bag.
- Check and remove all objects from pockets, eg lighters and matches.
- Never dry rubber articles, or any plastic items or film, eg plastic lined tablecloths and baby bibs.
- Clothes should go through the cool down/airing phase in the final part of the cycle. This ensures items are left at a temperature where they will not be damaged. If for any reason the dryer is stopped before the cycle has finished, dry clothes should be removed immediately and not left in the dryer. Clothes should be quickly spread out flat to cool so heat can dissipate, not left bunched up, eg in a clothes basket. Do not operate this product without the lint filter in place or allow lint to accumulate in or around the dryer.
- This dryer is not intended for use by persons (including children) with reduced physical, sensory or mental capabilities, or lack of experience and knowledge, unless given supervision or instruction concerning the use of the dryer by a person responsible for their safety.
- Children should be supervised to ensure they do not play with the dryer.
- Unplug the machine from the power supply when it is not in use.
- Do not swing on or put weight on the door.
- Your dryer is designed to stop operating in the event of power outage. When power is resumed, the machine will remain off until the 'Power' button is pressed. To restart the dryer, press 'Power', select your drying cycle and touch ►||.
- Never attempt to repair the dryer yourself.
- The only user-removable parts of the dryer are the lint filter, drying rack and reversible console. No other parts are designed to be removed by anyone other than a Fisher & Paykel trained and supported service technician.
- For problems that cannot be solved from information in this User Guide, turn off and unplug your dryer and contact a Fisher & Paykel trained and supported service technician.
- Do not overload your dryer beyond its rated capacity (eight kilograms of dry clothes).
- Never put dripping wet clothes in or on top of the dryer as excess water may cause an electrical hazard.
- Do not under any circumstances dry an electric blanket or any other electrical, plastic or rubber items in your dryer, unless the care label specifically states it is safe to do so. Never dry these items at high temperatures.
- Do not dry curtains in your dryer. Sunlight makes them brittle and they may disintegrate during drying.
- Do not use the water collected in the water tank for drinking or food processing.
- Never run the dryer without the water tank in place.
- If the water tank becomes full, the tumble dryer will pause drying and will sound an alarm. You must empty the water tank before the dryer can continue drying. Empty the tank, replace it back in the housing then touch ►|| to resume the cycle.

SAFETY AND WARNINGS

Lint

- Accumulated lint in the dryer can become a fire hazard; it also reduces the efficiency of the dryer by causing longer drying times and increased power consumption.
- Clean the lint filter before every load.
- Ensure the area around the dryer is clear of lint.
- At regular intervals have the interior of the dryer cleaned of any accumulated lint. This must be done by a Fisher & Paykel trained and supported service technician. This must be done when the dryer installation is changed from free standing.
- The dryer exhaust ducting should be inspected and cleaned periodically to remove accumulated lint.
- If the lint filter becomes damaged, contact your Fisher & Paykel trained and supported service technician to arrange getting a new filter. Do not operate your dryer with a damaged lint filter or without the filter in place, as this will cause damage to your dryer.

Installation

- The dryer must be installed in a well-ventilated, dust-free environment.
- The dryer must not be installed on any textured floor coverings (eg carpet, rugs) to ensure that openings at the base of the machine are not obstructed.
- Do not install the dryer behind a lockable door, sliding door, or behind a door where the hinge is on the opposite side to that of the dryer in such a way that the full opening of the door is inhibited. Ensure the dryer door can always be opened fully.
- Please refer to INSTALLATION INSTRUCTION section of this document for detailed installation steps.

SAFETY AND WARNINGS

Spontaneous combustion

IMPORTANT!

To reduce the risk of fire in a tumble dryer the following should be observed:

- Items that have been spotted or soaked with vegetable oil or cooking oil are a fire hazard and should not be placed in a tumble dryer.
- Oil-affected items can ignite spontaneously, especially when exposed to heat sources such as a tumble dryer. The items become warm causing an oxidation reaction in the oil. This oxidation creates heat. If the heat cannot escape the items can become hot enough to catch fire. Piling, stacking or storing oil-affected items can prevent heat from escaping creating a fire hazard.
- If it is unavoidable that fabrics that contain vegetable oil, cooking oil or have been contaminated by hair care products be placed in a tumble dryer, they should first be washed in hot water with extra detergent — this will reduce, but not eliminate the fire hazard. The cool down cycle of the dryer should be used to reduce the temperature of these items. They should not be removed from the tumble dryer and piled or stacked while hot.
- Items that have previously been cleaned in, washed in, soaked in or spotted with flammable liquids or solids, eg petrol/gasoline, kerosene, dry cleaning solvents, vegetable or cooking oil, acetone, denatured alcohol, some brands of spot removers, turpentine, waxes and wax removers or other flammable or explosive substances should not be placed in a tumble dryer.
- Do not dry unwashed items in the tumble dryer.
- The dryer is not to be used if industrial chemicals have been used for cleaning.
- Fabric Softeners or similar products should not be used in a tumble dryer to eliminate the effects of static electricity, unless this practice is specifically recommended by the manufacturer of the fabric softener product.
- Rubber backed articles, foam rubber (latex foam), clothes or pillows fitted with foam rubber pads, fibreglass, shoes containing rubber, shower caps, babies waterproof napkin covers and waterproof textiles should not be dried in the dryer. These materials can when heated produce fire by spontaneous combustion.
- When choosing to tumble dry a duvet/doona use low-medium heat only and make sure the drum is not overloaded due to the risk of overheating and scorching.
- Exhaust air must not be discharged into a flue which is used for exhausting fumes from appliances burning gas or other fuels.
-

Disposal

Extreme care must be taken when disposing of your old appliance to avoid hazards.

- When disposing of the dryer, it is recommended that the door is removed to avoid children getting trapped inside, and that the electrical cable is cut off close to the dryer.

INSTALLATION INSTRUCTIONS

Read and follow the 'Safety and warnings' and 'Installation instructions' sections carefully before using your dryer.

Moving your appliance

When moving your dryer only tip towards the right hand side (when viewed from the front). If the dryer has not been transported as described, leave it standing upright for at least one hour before turning on.

Accessories

Check you received the following accessories with your Fisher & Paykel dryer. You will find them inside the drum:

- 1 x Drying rack
- 1 x Drain hose
- 1 x Installation guide/User guide.

Unpacking

To ensure the best performance from your new dryer please follow the instructions below.

Removing the packaging

- ① Remove the outer packaging (including the polystyrene packer and plastic wrapping). All packaging must be removed prior to use.
 - ② Tilt the machine backwards and 'walk' it off the base one foot at a time. Not doing so may cause damage to your floor and dryer.
 - ③ Remove all packaging and accessories from inside the drum and ensure you remove protective covers from door and console.
- **Ensure packaging materials are kept out of reach of children.**

Location

This dryer CANNOT BE INVERTED AND MOUNTED ON THE WALL.

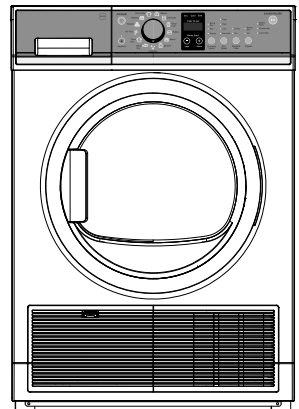

Free standing

INSTALLATION INSTRUCTIONS

Installation options

Your dryer can be installed one of two ways, either freestanding, or stacked on top of a Fisher & Paykel front loading washer.

① Freestanding

The dryer stands on the floor and can easily be moved into position.

② Stacking

Your dryer has been designed to be able to be stacked on top of a Fisher & Paykel front loading washer. **A stacking kit MUST BE USED between the products and fitted correctly to the washing machine and dryer, as per the stacking kit instructions.**

- Stacking Kit White: Part No. 427976.

① Move the machine into the desired position. Do not lift the dryer by the top panel.

② Have a minimum clearance on all sides of at least 20mm.

③ Install the machine on a stable and level floor (if not stacking on top of a front loading washer).

- Do not install your dryer in such a way that the dryer door cannot be opened fully.
- Do not install the dryer outside, in a damp place, where there is a risk of freezing, where it may be rained on, in direct sunlight or close to a source of heat.
- Do not place your machine on top of its power cable.

Levelling the machine

It is IMPORTANT to level the machine to ensure the machine runs efficiently with minimal noise. The dryer should be levelled in as close to its final position as possible so it stands balanced evenly on all four feet. Ensure the dryer does not rock in any direction.

The dryer comes with four adjustable feet, wind all four feet up or down until the dryer is correctly level. A spirit level can assist with this process. The machine is considered level when the bubble sits in the centre (ie within the two lines or the circle), when the spirit level is placed flat on top of your dryer, in the directions from:

- ① left to right
- ② back to front, and
- ③ corner to corner.

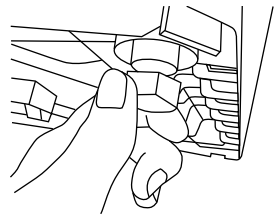

Levelling the feet

Never unscrew the feet completely from their housings.

Note: After levelling, the corners of the dryer cabinet should be clear of the floor and the machine must not rock in any direction.

INSTALLATION INSTRUCTIONS

Draining

The dryer is equipped with a condenser unit which accumulates water during the drying cycle. This water is collected in the removable water tank located at the top left of the dryer. The accumulated water must be emptied after each drying cycle. However you can also set up your dryer to drain automatically using the drain hose provided.

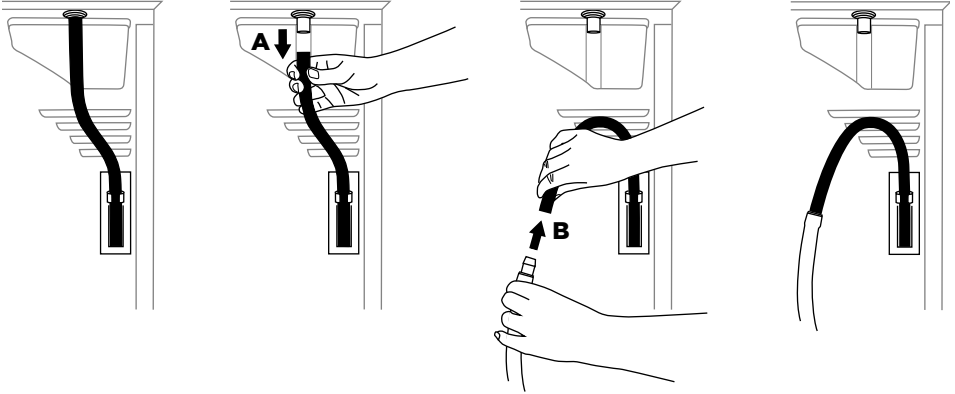

Connecting the drain hose:

- ① Remove the black hose from the connection at the back of the dryer (A).
- ② Uncoil the drain hose (included with your dryer) and connect it to the black hose (B).
- ③ Place the other end of the drain hose into a tub or standpipe.

If you connect the drain hose onto your dryer, the other end must be secured in a drain to prevent water draining onto the floor. Ensure the drain hose is securely fixed in place to an appropriate drain and is leak-free at the connection to the machine. Check the connection and drain hose regularly.

- Maximum standpipe height is 1.0m from ground level.
- Regularly check that your standpipe or tub is free from lint and other obstructions, which may affect drainage and cause flooding.
- The drain hose should be checked from time to time and replaced if any damage, eg wear, cuts, bulges, kinks, leaks, etc are found. Do not bend the drain hose sharply, as this may cause it to split.
- The extended length of the provided drain hose is 1.3m.
- In multi-storey apartments or any upper floor, the machine should be installed on a floor equipped with a drain.
- Draining must comply with local by-laws.

INSTALLATION INSTRUCTIONS



Electrical connection

- ① This appliance must be connected to a 220V – 240V, 50Hz, sinusoidal, 10A electrical supply.
 - ② Uncoil the power cord, remove and discard the plastic pin cover and plug into a power socket.
 - ③ Connect the appliance to an earthed outlet protected by a fuse of suitable capacity.
- Check the power cord for damage and make sure it is not squashed or twisted when installing the dryer.
 - Always remove the power cord from the power socket by the plug, not by the cord.

Completing the installation

Installation test cycle

Ensure the installation test cycle is completed before you dry any items in your dryer. This is to check that your dryer is installed correctly and that it is functioning properly prior to use.

- ① Turn your dryer on by pressing the 'POWER'  button.
- ② Select the 'Time Dry' cycle for 30 minutes. Ensure the drum is empty and the door is closed (you will hear it click shut).
- ③ Touch the  button. The drum will start rotating.
 - Observe the machine for any problems.
 - The dryer will beep and display any faults on the screen if there are any problems. Refer to 'Before you call for service', 'User warnings'.
- ④ At the completion of the cycle, open the door and check that there is warmth inside the dryer. This indicates the dryer is operating normally.

If there are any problems, you must address these before proceeding with normal use. The dryer will automatically turn off at the end of the cycle if there are no problems.

INSTALLATION INSTRUCTIONS

Before you start, it is a good idea to go through the following checklist:

- ① Has the packaging been removed?
- ② Is the machine correctly levelled, and are the cabinet corners clear of the floor and walls?
- ③ Are the water tank, condenser filter and lint filter correctly in place?
- ④ Has the power cord been connected to an appropriate power supply and the power turned on?
- ⑤ Have you performed the installation test cycle?
- ⑥ If external draining is preferred, is the drain hose attached to the correct outlet and hooked into a standpipe or tub?

Machine specifications

	DH8060P
Capacity (kg)*	8
DIMENSIONS (mm)	
Width	595
Depth	650
Height**	845
Length of drain hose	1300
ELECTRICAL	
Volts	220 - 240
Hz	50
Amps (maximum)	10
Power consumption (W)	900

* Capacity refers to the maximum **dry** weight of items the machine can dry at any one time.
Note: some cycles have a lower maximum capacity (see the 'Drying cycles' section).

** The exact height of your dryer is dependent on how far the feet are extended from the base of the machine.

CONTROL PANEL

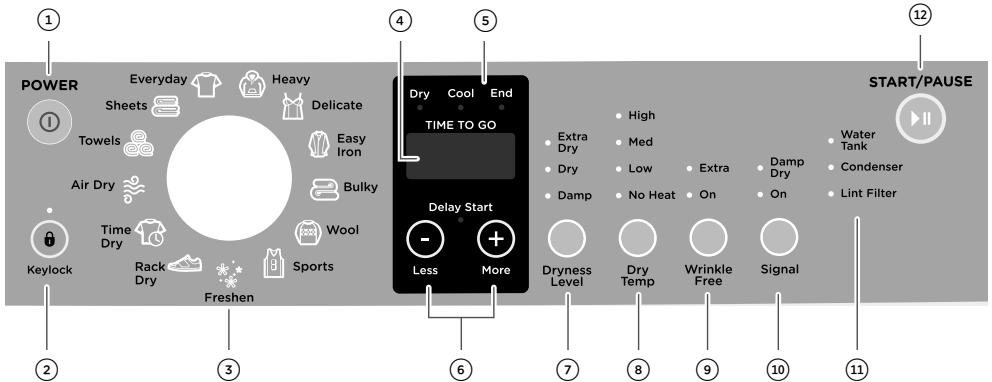

- | | |
|---|--|
| ① POWER | Press to turn the dryer on/off. |
| ② Keylock | Touch and hold for two seconds to disable all buttons on the display panel, except 'POWER' ① button. This prevents accidental button presses. |
| ③ SmartTouch™ control dial | Rotate to select your desired drying cycle. <ul style="list-style-type: none"> The icon illuminates to indicate the selected drying cycle. |
| ④ Digital display screen | Shows the following: <ul style="list-style-type: none"> How long the drying cycle has to go. Delayed start time of the drying cycle. Notifications if an error is detected or a warning is necessary. |
| ⑤ Progress lights | The progress lights indicate what part of the cycle the dryer is currently on ('Dry', 'Cool' or 'End'). All three lights are on at the beginning of the cycle. The light for the current part of the cycle flashes, and each one goes out when that part of the cycle is complete. |
| ⑥ Delay Start | Touch 'More' + to increase the delay start time for drying cycles. |
| ⑦ Dryness Level | Allows you to select the level of dryness for your load. |
| ⑧ Dry Temp | Allows you to select the drying temperature for your cycle. |
| ⑨ Wrinkle Free | Allows you to select a wrinkle free option for your cycle. |
| ⑩ Signal | This button has two functions: <ul style="list-style-type: none"> Alert you that the dryer has finished. Alert you to remove items once your load reaches the damp/dry stage. |
| ⑪ Water tank, Condenser, Lint Filter | The lights will flash when the machine is switched on as a reminder to empty the water filter, condenser or clean the lint filter. The warning light will also flash on and off during the cycle if the filters become blocked. |
| ⑫ START/PAUSE | Touch to start or pause the selected drying cycle. |

CONTROL PANEL

Timed cycles (Time Dry, Rack Dry, Wool)

When a timed cycle is selected the machine dries for the selected time regardless of the level of moisture in the load. It is important to check the items throughout the timed programmes to avoid over drying.

Timed programmes of 10 to 150 minutes can be selected using the 'More' + and 'Less' - buttons.

Airing/Cool down (Cool)

When the dryer has sensed that the load is dry it will automatically go into an airing or cool down cycle. During 'Cool' the drum tumbles and cool air is blown through the clothes. This cools the load to reduce creasing if the clothes are left in the dryer.



Time to go

Your dryer displays approximately how many minutes the cycle you are running has remaining if you have chosen one of the Time Dry cycles. If you have chosen an automatic cycle (ie not 'Time Dry') the word **AUTO** will appear on the screen until it reaches the cool down phase, at which time the dryer will display how long the cycle has left to go.

Be aware that a number of factors can influence the overall cycle time, eg the fabric type of garments, load size, the wetness of the load, environmental conditions etc.



Time to go

Indicators

There are a number of indicators to alert you when you need to attend to your dryer, either to clean the lint filter, empty the water tank or to clean the condenser filter (refer to the 'Caring for your dryer' section for more information).

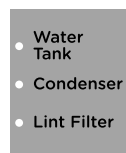

Indicators

Keylock

This option enables you to deactivate the buttons on the display panel, except for the 'POWER' **ⓘ** and **🔒** buttons. This option helps prevent accidental button touches.

To turn Keylock ON or OFF, at any time when the dryer is powered on:

- Touch the **🔒** button for two seconds.

Note: When activated the **🔒** button is illuminated.

If Keylock is activated and the dryer is off:

- Press the 'POWER' **ⓘ** button, then touch the **🔒** button for three seconds to turn Keylock off. Select your drying cycle, any options and then touch **▶▶** to start the cycle.

DRYING CYCLES

Your dryer has a number of drying cycles to suit your laundry needs. Selecting the most appropriate cycle for each particular load will help ensure you get the best result.

CYCLE	DESIGNED FOR	DESCRIPTION	MAX. LOAD SIZE (KG)	DEFAULT DRYNESS LEVEL*	DEFAULT DRYING TEMP
Everyday**	Everyday clothing eg t-shirts, trousers.	High heat cycle for rapid drying of everyday clothing.	8	Dry	High
Heavy	Heavy durable garments, eg work sweatshirts/ jerseys, rugby shorts, jeans, tea towels.	A longer, high heat cycle for heavy fabrics and denim.	8	Dry/ Extra Dry	High
Delicate	Delicate clothing items, eg synthetics, silk and fine fabrics.	A shorter, cooler cycle for carefully drying delicate and heat sensitive fabrics.	4	Dry	Low
Easy Iron	Business shirts and clothing that creases easily.	A short, medium heat cycle with the 'Wrinkle Free' option is automatically selected for easily creasable items.	4	Damp/Dry	Medium
Sheets	Sheets, pillowcases and duvet/duona covers.	High heat cycle with reversing, to improve the movement of large items such as sheets and duvet/duona covers and help reduce tangling.	4	Dry	High
Towels	Towels.	High heat cycle for drying thick, absorbent items such as towels.	6	Dry	High
Bulky	Bigger items like jackets and duvet/duona covers.	A medium heat cycle for the special care of bulky items.	4	Dry	Medium
Sports	Sports clothing, eg running gear.	A low heat cycle designed to care for synthetic sports clothing.	4	Dry	Low
Wool	Woollen items, eg jerseys.	A low heat cycle for use with the drying rack to dry machine washable woollen items without tumbling. User selectable drying times of 30-150 minutes.	3	n/a	Low
Rack Dry	Items that cannot be tumbled, eg shoes, hats, delicate garments.	Specifically for use with the drying rack so items can be dried without tumbling.	3	n/a	Low
Freshen	Items that have been in storage or have not been worn/used for some time.	A short cycle with a burst of heat followed by cool air to help de-wrinkle and refresh items.	2	n/a	High
Time Dry	Drying items for a selected time period.	A cycle with user select 10-150 minute drying times.	8	n/a	High
Air Dry	Drying items for a specific time period, without heat.	40 minute cycle with no heat.	4	n/a	No Heat

* Dryness level is only an option on automatic sensing cycles. On 'Time Dry' and the 'Rack Dry' cycle, dryness will vary depending on the load and its initial moisture content.

** 'Everyday' cycle, 'Dry' dryness level and 'High' drying temp is the recommended cycle for everyday cotton items.

SORTING AND LOADING

When preparing your load there are some important things to consider:

Sorting

- We recommend sorting your garments before placing them into the dryer. Sort into loads of similar items, and loads that will likely take similar times to dry. Heavier items (eg towels, and flannelette sheets) are best dried separately from lightweight items (eg synthetics, polyester-cotton sheets and shirts). This prevents the possibility of some items becoming over-dried whilst others are still damp. It will also help to extend the life of your clothing and linen.
- Care labels on garments provide valuable information about the fabric type and how the garment should be dried. Always follow the advice on garment labels. Only dry items in this dryer that have a care label stating tumble drying is suitable.
- Drying your clothes as soon as you remove them from the washer will decrease the chance of wrinkles forming, and dye transfer from coloured items to white items from occurring.
- Separate coloured items from white/light items where possible, especially when new. Colour run may be an issue, especially if you intend to delay the start of the drying cycle.
- We recommend that articles of clothing with screen-printing are turned inside out to prevent damage to the print. Garments with hooks or zippers should be fastened and where possible, turned inside out.

SPECIFIC ITEM/DRYING REQUIREMENTS	SUGGESTED CYCLE AND OPTIONS	SUGGESTED TEMPERATURE	COMMENTS
Towels	Towels	High	Towels produce a lot of lint and are best dried on their own.
Sheets, pillowcases, duvet/doona covers	Sheets	High	Ensure duvet/doona cover openings are buttoned/domed before placing in the dryer.
Bulky items - doonas, duvets, sleeping bags, jackets	Bulky	Medium	Dry only one bulky item at a time and place a knotted towel into the machine at the same time to ensure the bulky item moves around evenly.
Business shirts, trousers, other creasables	Easy Iron	Medium	'Wrinkle Free' is automatically selected to help minimise creasing once the drying cycle has finished.
Woollens, silks	Wool	Low	Designed for items that could be damaged if they are tumbled, eg woollens. Use the drying rack.
Delicates, fine fabrics	Delicate or Rack Dry	Low	You can further reduce the dryness level to damp or use Rack Dry for very delicate items.
Jeans	Heavy	High	Turn jeans inside out to help maintain their appearance. Dry separately from other items.
Shoes, hats, soft toys or other odd shaped items	Rack Dry	Low	Check on the item regularly throughout the drying cycle. Ensure the rack has been correctly fitted. Only dry shoes on 'Low' drying temp.

SORTING AND LOADING

Before you load

- Check pockets for items that could damage your clothes or get caught in the dryer.
- Close zippers, hooks and eyes, and other fastenings (ie fasten the openings of duvet/duona covers), and remove loose bra wires. These may damage both your dryer and your clothes.
- Check the lint filter is clean and the water tank is empty (if the dryer is not set up to drain automatically).

Loading

Garments need to be loaded correctly to minimise creasing and wrinkling, and to ensure the load is dried evenly.

- Allow enough room in the dryer for clothes to tumble freely. (Hint: load the dryer in terms of the space the garments take up when dry, rather than when they are wet).
- Shake clothes out and load individually to help items dry evenly and reduce tangling.
- Only dry a sheet load up to a maximum of 4kg in the dryer at one time.
- Dry permanent press garments (business shirts) together on the 'Easy Iron' cycle with the 'Wrinkle Free' option on. This will help reduce wrinkling and the need for ironing.
- Hang garments as soon as the drying cycle is complete to reduce the need for ironing.

SORTING AND LOADING

Drying times

- Drying very small loads is inefficient. Try to dry medium to large loads.
- Heavier items (towels, flannelette sheets) will take longer to dry than light items (synthetics and polyester cotton sheets and shirts).
- Drying times can be reduced by spinning the wash load at the highest spin speed suitable for the load type in your washing machine.
- Check bulky items during the cycle to ensure even drying. Pause the dryer and reposition the item if necessary.

Lint

Some items are lint givers, while others are lint collectors. Always dry lint givers and collectors separately.

LINT GIVERS	LINT COLLECTORS
Towels	Synthetics eg polar fleece
Flannelette sheets	Corduroy
	Polyester cottons

Delicate or easily damaged items (eg woollen or silk garments, nylon stockings, fine fabrics, delicate embroidered fabrics) should be dried separately, using the 'Delicate' or 'Ultra Delicate' cycle, or if you do not want them tumbled use the 'Wool' or 'Rack Dry' cycle. Sleeping bags and other down items should be dried on the 'Bulky' cycle.

Drying rack

There are many items that would benefit from being dried on a drying rack. For example items such as sport shoes, soft toys, hats and woollen items that may be damaged if they are tumbled.

A drying rack is installed in your dryer when it leaves the factory. To remove it, tilt the top of the rack towards you to detach the legs from the slots in the lint filter, and gently remove from the drum.

When you are using the drying rack you must select the 'Rack Dry' or 'Wool' cycle.

If the Rack is not properly installed or if a garment has fallen from it, a user prompt will appear on the digital display screen. Replace the Rack and touch the ►|| to resume the cycle.

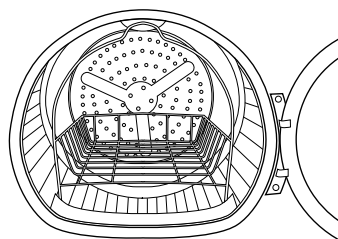

Drying rack



Drying rack cycle

GETTING STARTED QUICKLY

- **Check the lint filter is clean and the water tank is empty before every load. Ensure both are replaced correctly before using your dryer.**
 - **Sort and load items into the dryer drum, ensuring no items are in the way of the door. Close the door (you will hear it click shut).**
- ① Press 'POWER' **ⓘ** to activate your dryer.
 - ② Your dryer will default to the 'Everyday' cycle. Select your desired drying cycle by turning the SmartTouch™ Control Dial.
 - ③ Select your preferred drying options, using the SmartTouch™ buttons on the right hand side of the panel (if you wish to select options different from the default options for the cycle).
 - ④ Touch the **▶||** button to start the cycle.
- If you make an invalid selection the dryer will beep to alert you.
 - When the cycle finishes, your dryer will beep and then turn off automatically. If the 'Wrinkle Free' option has been selected the machine will rotate the drum periodically blowing cool air into the drum to help minimise wrinkling and creasing of your load.
 - If you wish to change a cycle or select a different option once a drying cycle has started, touch the **▶||** button then select the new cycle or option. Touch **▶||** to restart the dryer with the new cycle and/or settings.
 - **If you wish to stop the dryer before the cycle has finished, you MUST remove the clothes IMMEDIATELY and spread them out to cool. DO NOT leave the clothes in the dryer or bunched up in a clothes basket. Take extreme care as the drum and the load items may be hot.**
 - **Failure to follow the advice in this guide may result in damage to your garments and your expectations of drying performance may not be met.**

Delay Start

The 'Delay Start' option enables you to delay the start of the drying cycle from between 15 minutes and 12 hours. Delayed start options are 15 minutes, 30 minutes, 1 hour, then hourly up to 12 hours. This can be useful to time your drying to finish when you arrive home from work, or to start when power rates are lower.

To 'Delay Start' your cycle:

- ① Select the cycle.
- ② Press 'More' **+** to increase the delay time.
- ③ Press **▶||** to confirm your selection and start the countdown.
- ④ The display will indicate the time until the cycle will start.

To decrease or turn off 'Delay Start':

- ① Press 'Less' **-** to decrease the delay start time or to turn 'Delay Start' off.

Avoid using 'Delay Start' for damp, non-colourfast items as this may cause dye run to occur.

Drying Cycle Options

All drying cycles default to the recommended options for that cycle based on the average expected load to be dried using that cycle. You can vary the options (eg 'Dryness Level', 'Dry Temp') to create your desired cycle.

After using your dryer a few times you may discover there are some drying options you prefer for some cycles. You can programme your dryer to remember the drying options you prefer for each drying cycle. For instance, you may want to set the 'Easy Iron' cycle to a lower drying temperature or programme the 'Everyday' cycle so it automatically has the 'Wrinkle Free' option selected.

To change a drying cycle option:

- ① Press 'POWER' **ⓘ** to turn the machine on.
- ② Turn the dial to select the cycle you wish to customise.
- ③ Touch and hold any of the drying options buttons for three seconds. The lights will flash on and off and the display will show 'SE' to indicate that the machine is in cycle adjustment mode.
- ④ Select the drying options you prefer by touching the relevant option button.
- ⑤ Touch **Ⓛ** to save the selected settings. The dryer will beep to indicate your customised cycle has been saved.

Note: Touching **▶||** before pressing **Ⓛ** will exit the cycle adjustment mode and start the cycle using the settings shown on the display panel.

To change the cycle or options you have selected after a cycle has started:

- Touch **▶||** and select your new cycle or options, then touch **▶||** again to resume drying.

Note: Some options may not be available for selection under certain conditions and after particular stages of the drying cycle have passed.

CUSTOMISING DRYING CYCLE

DESCRIPTION

Dryness Level

When your dryer senses that the clothes have dried to the dryness level selected, the dryer will automatically finish the cycle.

Note: Two lights are used to show some dryness levels, eg to achieve the 'Damp Dry' setting both the 'Dry' and the 'Damp' dry lights will be illuminated.

OPTIONS

Five dryness levels from 'Damp' through to 'Extra Dry'. If you want to change from the default dryness, you can choose the dryness level to suit your load depending on how dry you want your items to be.



Dry Temp

There are four drying temperatures you can choose from for your cycle.

Clothes temperatures reach up to:

High: 80°C.

Medium: 70°C.

Low: 45°C.

No heat: Cool air is blown through the dryer for the period selected.

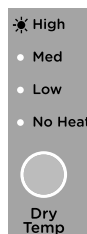

Wrinkle Free

To minimise wrinkling, select one of the 'Wrinkle Free' options. At the end of the cycle, the drum will rotate periodically and cool air will be circulated through the load to minimise wrinkling and creasing. This is particularly useful if you cannot remove the items immediately after the cycle ends.

- 'ON' provides 'Wrinkle Free' operation for 1 hour.
- 'Extra' provides 'Wrinkle Free' operation for 24 hours.

If you wish to stop the dryer at any point during the 'Wrinkle Free' stage of the cycle, simply touch ►II. You can then open the dryer door and remove your items. Press 'POWER' ⓘ to turn the dryer off.



Signal

'Signal' has two functions:

- ① Alert you that the dryer has finished. A series of beeps will sound at the end of a cycle.
- ② Alert you to remove items once your load reaches the damp/dry stage, then it will continue drying until the remaining load reaches the dryness level you selected.

The 'Signal' option automatically defaults to 'On' for all cycles. You can turn the 'Signal' off by touching the 'Signal' button twice (no lights will then be illuminated).

To turn 'Damp/dry' signal on:

- Touch the 'Signal' button once. Ensure 'On' is also selected.



Reset defaults

You can reset your dryer to the default settings it left the factory with:

- ① Turn the dial to select the 'Freshen' cycle.
- ② Touch and hold the 'Delay Start', 'More' +, the 'Delay Start', 'Less' - and 'Signal' buttons together for three seconds.
- ③ Your dryer will now be reset to the default settings it left the factory with.

CARING FOR YOUR DRYER

When you have finished using your dryer

- Unplug the machine from the power socket.
- Wipe around the door to remove any remaining condensation and foreign matter.
- Clear the lint filter and empty the water tank (if not set up to automatically drain).

Cleaning your dryer

Before you start cleaning your dryer, ensure that it is disconnected from the power (ie unplug the machine from the power socket).

Cleaning the control panel and outer surfaces of the dryer

Use a soft damp cloth to wipe all surfaces, then wipe dry. Avoid using chemical or scouring cleaners, as these will damage the paint and plastic surfaces of your dryer.

Cleaning the inside of your dryer

It is important that you occasionally clean the inside of your dryer. If the drum has any residual dirt or lint stuck to it, remove this and wipe it clean with a damp cloth. Do not leave any metal objects in the drum, as these may cause rust.

Cleaning the filters

Cleaning the door lint filter

- Lint is generally formed during wearing and washing. Fibres (ie lint) released from the clothes during the drying cycle are collected in the lint filter.
- It is important to clean the door lint filter after every load, as the lint produced in the drying process can become a fire hazard if it is allowed to accumulate in or around your dryer.
- A warning light will flash at the start of every cycle to remind you to clean the door lint filter, then turns off once you touch ▶|| to start your cycle.
- The warning light will flash on and off during the cycle if the door lint filter becomes blocked. When this occurs the lint filter should be cleaned immediately.
- The door lint filter is located in the door opening (at the bottom).

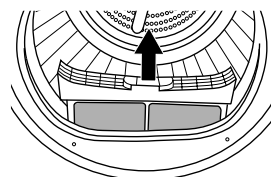

Lint filter

To clean the door lint filter:

- ① Open the dryer door.
- ② Remove the lint filter by pulling it up and out of the filter slot. Open it out and wipe the surfaces clean with your hand.
- ③ Close the lint filter and place it back in the opening. Ensure the filter is fitted correctly back in place before operating the dryer.

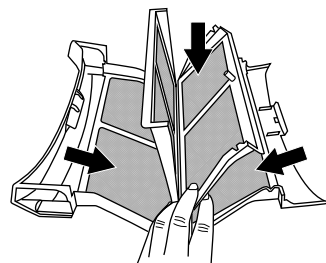

CARING FOR YOUR DRYER

Cleaning the condenser filter and evaporator grid

To maintain optimum performance of your dryer the condenser filter and evaporator grid must be cleaned. The condenser filter and lint filter lights will flash when the condenser filter requires cleaning, then turn off once you touch ▶|| to start your cycle.

- The condenser filter is located below the door on the left-hand side.
- The evaporator grid is located behind the condenser filter.

To clean the condenser filter:

- ① Switch off the power supply and remove the power plug.
- ② Open the condenser filter cover.
- ③ Turn the four condenser lock levers 90° then pull out the condenser filter.
- ④ Remove rear filter and wipe the surface clean with your hand.

To clean the evaporator grid:

- ⑤ With the condenser filter removed you will be able to see the evaporator grid. If the surface of the evaporator grid is dirty, clean it carefully with a vacuum cleaner using a dusting brush or a narrow crevice nozzle. Be gentle and do not bend the fine metal fins.

Cut Hazard. The surface of the evaporator has sharp edges and contact may result in injury. Handle with care when cleaning the grid and always keep blades away from fingers and body.

- ⑥ Replace the condenser filter.
- ⑦ Turn the four condenser filter lock levers to lock the condenser filter back in place again. Make sure that these locks are engaged securely.
- ⑧ Close the condenser filter cover.

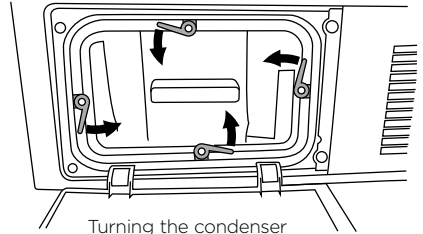

Turning the condenser filter locking levers

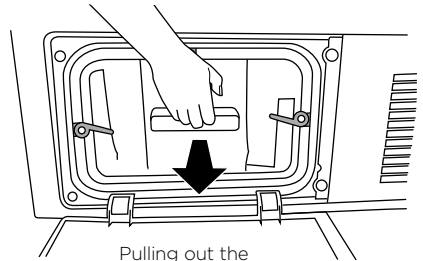

Pulling out the condenser filter

CARING FOR YOUR DRYER

Emptying the water collection tank

During the drying cycle, steam condenses into water and is collected in the water tank, located at the top left of the dryer. It is important to empty the water tank after every load.

If the water tank becomes full during operation, the dryer will pause, display a user prompt and beep to alert you. You must empty the tank before the dryer can continue drying. Empty the tank, replace it in the housing then touch ►|| to resume the cycle.

Note: You do not need to empty the water tank if you have set up the drain hose to drain the water automatically.

To empty the water tank:

- ① Remove the water tank by holding onto the handle and pulling outwards gently to remove it. Ensure that you keep the tank level when it is being removed to prevent the water collected from spilling.
 - ② Pour the water down the sink or into a bucket, and then put the tank back in place.
- **Never run the dryer without the water tank in place unless the drain hose has been installed.**

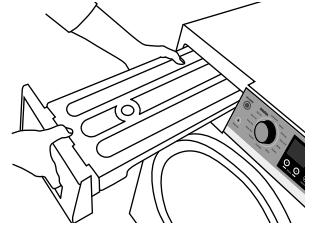

Removing the water collection tank

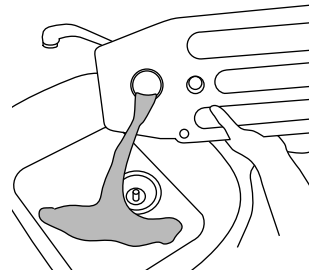

Tipping out the water from the condensing tank

Cleaning the sensors

There are sensors in your dryer that detect whether the laundry is dry or not. These sensors need to be cleaned periodically (we recommend approximately four times a year).

To clean the sensors:

- ① Open the door of your machine.
- ② Allow the machine to cool if drying has been carried out.
- ③ Locate the metal sensors just behind the lint filter.
- ④ Wipe the sensors with a soft cloth, dampened with vinegar. Dry the sensors with a soft dry cloth.

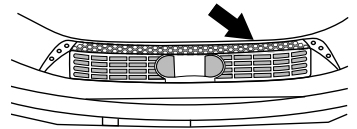

Location of the sensors

BEFORE YOU CALL FOR SERVICE

User warnings

Your dryer is capable of diagnosing a number of its own problems. It will sound a continuous series of beeps and display a user prompt when it has a problem that you can correct yourself. To stop the beeps sounding, touch any button on the control panel. Do not try to continue your drying cycle once you stop the noise. You must address the problem the dryer is alerting you to.

Check the below table before you call for service.

PROBLEM	DISPLAYED AS	WHAT TO DO
Keylock is activated	KEY LOC	Touch and hold the 'Keylock' button for 2 seconds to deactivate the Keylock.
The lint filter is blocked and needs to be emptied	CLN LINT	Empty the lint filter and then replace it. Check the lint filter is not damaged. Check there is nothing else stuck in the lint filter holder which may be blocking the air flow. Check the lint filter is in place correctly in your dryer. Clean the condenser filter (refer to the 'Caring for your dryer' section). Ensure the condenser filter unit has been placed or replaced correctly into your dryer.
The water tank is full and needs to be emptied	H2O FULL	Check if the water tank is full. Empty the water tank. If using the drain hose, check whether the water tank or drain hose is blocked. Check the drain hose is still attached at the back of the machine, and is not kinked or squashed.
The door is not closed	door	Close the door fully and touch ►► . Try opening and closing the door again. Reposition the load, making sure the load is correctly in the drum and that protruding items are not preventing the door from closing.
The drying rack is not in place	FRK FRK	Fit the drying rack.

Once you have addressed the issue the user prompt was alerting you to, try using your dryer as per usual. If the issue persists, call your Fisher & Paykel trained and supported service technician.

FAULT CODES

When a continuous series of beeps sounds, all the lights turn off on the control panel and a number appears on the display, a fault has occurred. The dryer will automatically enter this mode if a fault occurs. The word 'Fault' will be shown in the control panel display followed by a number. To stop the beeps, touch any button then perform the following steps:

- ① Turn your machine off at the power point.
- ② Wait one minute and turn it back on.
- ③ Check your machine is installed correctly (refer to 'Installation instructions' section).
- ④ Remove your load from the dryer and retry.
- ⑤ Perform a 'Time Dry' cycle, eg Time Dry for 30 minutes.
- ⑥ If the fault re-occurs repeat steps ① and ②.
- ⑦ If the machine still will not work call a Fisher & Paykel trained and supported service technician to arrange service (refer to 'Customer care' section). Record the fault code number displayed and the serial number of your dryer (located on the rear of the machine, or on the inside of the door below the glass) before calling. The fault code will indicate to the service technician what the problem could potentially be.

If a fault code is being displayed, you can still turn your dryer off by pressing 'POWER' ①.

TROUBLESHOOTING

The following is a list of problems you may encounter when using this appliance and some suggestions that may help to correct the problem. If you still have problems, contact your Fisher & Paykel trained and supported service technician.

PROBLEM	POSSIBLE CAUSES	WHAT TO DO
Pressing 'POWER' ① does not turn on the dryer	Fault with household power supply.	Try plugging in and turning on another electrical device.
Dryer does not heat	Dryer set to 'Air Dry' cycle.	Check what cycle the dryer is set to (refer 'Drying cycles'). Change to preferred cycle.
	Full water tank.	Refer to 'Emptying the water collection tank'.
	The dryer has progressed to 'Cool'.	Check the progress lights- are 'Cool' or 'End' lights illuminated? Refer to 'Dry progress'.
Touching ► does not start the drying cycle	Dryer door not closed properly.	Open and close the door. Check that the lint filter is correctly in place and not obstructing the door.
	Is the dryer displaying a user warning or fault code?	Refer to 'User warnings' and 'Fault codes'.
	Water tank full or not properly in place.	Refer to 'Emptying the water collection tank'. Ensure the water tank is properly in place.
	Lint filter needs to be emptied.	Empty the lint filter and ensure it is correctly in place.
	Dryer is overloaded.	Remove some items from the dryer.
	'Delay Start' function is set.	Refer to 'Delay Start' for more information.
	Keylock is ON.	To disable touch and hold 🔒 button for two seconds.
Dryer keeps stopping and starting	The 'Wrinkle Free' option has been selected.	Refer to 'Wrinkle Free' for more information.
Dryer stops working mid-cycle	Power failure.	Press 'POWER' ① and restart the desired cycle.
	Dryer has been paused.	Touch the ► button to restart the cycle.
	Dryer door is open.	Ensure the door is firmly shut.
	Items fell off the rack when using 'Rack Dry' cycles.	Ensure the rack is installed correctly (refer to 'Sorting and loading', 'Drying rack') and replace garments that may have fallen from it.

TROUBLESHOOTING

PROBLEM	POSSIBLE CAUSES	WHAT TO DO
Dryer is taking too long /results were not satisfactory	Drying cycle selected not appropriate for the load.	Select an appropriate cycle for the load. Refer to 'Drying cycles'.
	Dryness level selected not appropriate for the load.	Select a higher dryness level. Refer to 'Dryness Level'.
	Dryer overloaded for the cycle.	Some cycles have a lower max load size. Refer to 'Drying cycles'.
		Try dividing the load in half and dry half at a time.
	Lint and/or condenser filter is blocked.	Clean the lint/condenser filter.
	Water tank is full.	Refer to 'Emptying the water collection tank'.
	Environmental conditions may be affecting dryer operation.	In particularly hot or cold conditions the dryer will take longer to dry a load and be less efficient. Ensure the dryer is installed in a well-ventilated, dust-free environment. Do not operate this dryer behind closed doors (ie inside a cupboard).
	Load overly wet at the start of cycle.	Remove more water from the load before placing it in the dryer, eg select a faster spin speed on your washer, if appropriate for your load.
	Load was damp dry at the start of cycle.	If the load had been partially air dried, eg has been washed and placed on the line, use a 'Time Dry' cycle and monitor the dryness of your clothes.
Dryer not draining water out properly.	Check the drain hose (if connected) for blockages or damage. You may need to call for service refer to 'Customer care' section.	
Items got tangled.	Try separating items and drying similar items together. Refer to 'Loading' for further tips.	
Dryer is not draining	Drain hose not connected to the water tank.	Ensure the drain hose is connected correctly. Refer to 'Draining' in the installation section of this guide.
	Water tank not in place correctly.	Ensure water tank is properly in place.
	Drain hose or drain blocked or damaged.	Check drain hose (if connected) and drain for blockages or damage.

TROUBLESHOOTING

PROBLEM	POSSIBLE CAUSES	WHAT TO DO
Clothes getting too hot or damaged	Cycle selected not appropriate for the load.	Ensure the cycle selected is appropriate for items in the load. Refer to 'Drying cycles'.
	Items removed from dryer before the end of cycle cool down had finished.	Removing items before cool down may damage clothing if it is not spread out and exposed to air to cool once removed from the dryer.
Dryer is beeping and displaying a code on the digital display	Dryer has a fault.	Try turning the dryer off and waiting 30 seconds before turning it back on. Refer to 'Fault codes'.
Small puddle of water coming from under the machine	Water tank not correctly in place.	Ensure the water tank is correctly in place.
	Water tank may need to be emptied.	Refer to 'Emptying the water collection tank'.
	Water tank may be damaged.	Check the water tank for any signs of damage.
	Drain hose may not be attached properly at the machine end.	Ensure the drain hose is attached properly. Refer to 'Draining' in the installation section of this guide.
	Drain hose could be damaged.	Check the drain hose for damage.
	Drain hose has slipped out of the drain.	Ensure the drain hose is securely fixed in place. Sometimes drain hoses can move or get displaced, which may lead to water draining onto the floor.
	Drain may be blocked.	Check the drain for any blockages.
	Dryer door not closing properly, affecting the seal.	Ensure the dryer door is closed properly and there is nothing obstructing the door opening.
Small amount of water in the drum at end of cycle	Water tank needs to be emptied.	Refer to 'Emptying the water collection tank'.
	Environmental conditions may be affecting dryer operation.	If conditions are particularly hot, humid or cold, it is possible vaporised water may re-condense in the drum or on the inside of the door.

TROUBLESHOOTING

PROBLEM	POSSIBLE CAUSES	WHAT TO DO
Noises	Dryer is overloaded.	Remove some items from the dryer.
	Dryer has a fault.	Continuous beeping or a musical series of beeps with a message displayed on the display. Refer to 'Fault codes'.
	Beeps signalling the end of a drying cycle.	End of cycle beeps can be turned off refer to 'Customising drying cycle'.
	Dryer has not been levelled properly.	Refer to 'Levelling the machine' in the installation section of this guide.
	Dryer makes unfamiliar noises.	At the start of the cycle the dryer may make some unfamiliar noises when the compressor turns on. This is normal.
Vibration	Dryer is not installed on a stable surface.	Ensure the dryer is installed on a flat, stable surface. Refer to 'Levelling the machine' in the installation section of this guide.
	Dryer is not level.	Ensure the dryer is correctly levelled. Refer to 'Levelling the machine' in the installation section of this guide.
	Dryer is overloaded.	Remove some items from the dryer.
Creasing	Cycle selection not appropriate for the load.	Select the 'Easy Iron' cycle to minimise creasing.
	Dryer is overloaded.	Remove some items from the dryer.
	'Dryness Level' selected too high for load type.	Try selecting a lower 'Dryness Level'.
	'Wrinkle Free' option not selected.	Select the 'Wrinkle Free' option to rotate the load at the end of the drying cycle. Refer to 'Wrinkle Free' section of this guide for details.

TROUBLESHOOTING

PROBLEM	POSSIBLE CAUSES	WHAT TO DO
Linting	Lint filter not cleaned or replaced.	Ensure the lint filter is cleaned after every cycle and replaced correctly. Refer to 'Cleaning the filters'.
	Loads not sorted correctly.	Dry lint-giving items separately from lint receivers. Also, dry similar colours together, eg light coloured items with light coloured items, dark items with dark items. Refer to 'Sorting and loading', 'Lint'.
	Clothes over dried.	Over drying clothes in the dryer can cause them to attract lint. Use an auto sensing cycle or ensure you check your load if using the time dry cycles to avoid over drying. Refer to 'Drying cycles'.
	New items have been dried in the dryer recently.	Clean the lint filter and use 'Cool Air' cycle to clear any remaining lint from the dryer.
	New towels or flannelette sheets can leave lint in the dryer, which may be picked up by subsequent loads.	
Fabric damage	Instructions on care label not followed.	Follow the instructions on the care label of the items.
	'Dryness Level' selected not appropriate for the fabric type.	Ensure the 'Dryness Level' selected is appropriate for the fabric type. Refer to the items care label. Refer to pages 'Drying cycles'
	Metal parts on the items or in the load.	Fasten zips and other clasps before placing items in the dryer.
	Items not separated or dried on an appropriate cycle for the fabric type.	Dry similar items together. Ensure an appropriate cycle is selected. Refer to 'Drying cycles'.
	Items fell off the rack when using 'Rack Dry'.	Ensure the rack is installed correctly (refer to 'Sorting and loading', 'Drying rack') and only one or two garments are placed on the rack at a time.
	Used a 'Time Dry' cycle and did not monitor the dryness of clothes during the cycle.	Ensure that clothes are checked for dryness during the cycle when using the timed programmes to avoid over drying. Refer to 'Customising drying cycle'.

TROUBLESHOOTING

PROBLEM	POSSIBLE CAUSES	WHAT TO DO
Dye transfer	White/light and coloured items not separated before drying.	Remember to separate white/light and coloured items before placing them in the dryer.
	Wet items left sitting in the dryer for long periods of time before drying.	Refer to 'Sorting' for tips to prevent dye transfer.
Tangling	Loads not separated during loading.	Try separating out larger items from smaller items.
	Items loaded into the dryer incorrectly.	Load items individually into the dryer. Do not place folded items in the dryer.
	Incorrect cycle selection.	Try using the 'Easy Iron' cycle to dry shirts and the 'Sheets' cycle to dry sheets. Refer to 'Drying cycles'.
	Load size too large.	Try drying smaller load sizes. Some cycles have a lower maximum load size. Refer to 'Drying cycles'.
	Delicate items not dried on 'Rack dry'.	Dry pantyhose, bras, stockings and any other delicate items prone to tangling on the 'Rack Dry' cycle.
	Sheets and duvet/doona covers due to their size, are prone to tangling.	Dry sheets and duvet/doona covers separately from other laundry, apart from towels. Ensure duvet/doona covers are buttoned or fastened closed before drying. Try adding a knotted towel to sheets loads if you are experiencing a lot of tangling.

MANUFACTURER'S WARRANTY

For New Zealand and Australia only. You automatically receive a 2 year Manufacturer's Warranty with the purchase of this heat pump clothes dryer covering parts and labour for servicing within the country of purchase.

Fisher & Paykel undertakes to:

Repair or, at its option, replace without cost to the owner either for material or labour any part of the product, the serial number of which appears on the product, which is found to be defective within TWO YEARS of the date of purchase.

Note: This Manufacturer's Warranty is an extra benefit and does not affect your legal rights.

This Manufacturer's Warranty DOES NOT cover

- (A) Service calls which are not related to any defect in the product. The cost of a service call will be charged if the problem is not found to be a product fault.
For example:
 - ① Correcting the installation of the product.
 - ② Instructing you how to use the product.
 - ③ Replacing house fuses or correcting house wiring or plumbing.
 - ④ Correcting fault(s) caused by the user.
 - ⑤ Noise or vibration that is considered normal, eg drain/fan sounds, machine noises or user warning beeps.
 - ⑥ Correcting damage caused by pests, eg rats, cockroaches, etc.
 - ⑦ Poor drying performance due to incorrect installation and maintenance eg blocked lint filter, blocked condenser or full water tank.
 - ⑧ Poor drying performance due to incorrect loading, eg overloading or underloading.
 - ⑨ Damage from articles in the drum, eg bra wires, pens, crayons, dye transfer or flammable material.
- (B) Defects caused by factors other than:
 - ① Normal domestic use; or
 - ② Use in accordance with the product's User guide.
- (C) Defects to the product caused by accident, neglect, misuse or 'act of God'.
- (D) The cost of repairs carried out other than by a Fisher & Paykel trained and supported service technician or the cost of correcting such repairs.
- (E) Normal recommended maintenance as set out in the product's User guide.
- (F) Repairs when the appliance has been dismantled, repaired or serviced by other than a Fisher & Paykel trained and supported service technician or the selling dealer.
- (G) Pick-up and delivery.
- (H) Transportation or travelling costs involved in the repair when the product is installed outside the Fisher & Paykel trained and supported service technician's normal service area.

Nothing in this Manufacturer's Warranty is intended to, or does, limit any rights you may have under law to recover the costs of inspecting or returning the goods to us.

MANUFACTURER'S WARRANTY

This product has been designed for use in a normal domestic (residential) environment. This product is not designed for commercial use (whatsoever). Any commercial use by a customer will affect this product's Manufacturer's Warranty.

Service under this Manufacturer's Warranty must be provided by a Fisher & Paykel trained and supported service technician (refer to the 'Customer care' section at the back of this book). Such service shall be provided during normal business hours. This Manufacturer's Warranty certificate should be shown when making any claim.

For Australian Customers

This Manufacturer's Warranty is an extra benefit and does not affect your legal rights. Our goods come with guarantees that cannot be excluded under the Australian Consumer Law. You are entitled to a replacement or refund for a major failure and for compensation for any other reasonably foreseeable loss or damage. You are also entitled to have the goods repaired or replaced if the goods fail to be of acceptable quality and the failure does not amount to a major failure.

Please keep this User guide in a safe place.

CUSTOMER CARE

Before you call for service or assistance...

Check the things you can do yourself. Refer to your User guide and check:

- ① Your product is correctly installed.
- ② You are familiar with its normal operation.
- ③ You have read the 'Before you call for service', 'Fault codes' and 'Troubleshooting' sections at the back of the book.

If after checking these points you still need assistance or parts, please refer to your nearest Fisher & Paykel trained and supported service technician, Customer Care, or contact us through our website fisherpaykel.com.

In New Zealand if you need assistance...*

Call the Fisher & Paykel Customer Care Centre and talk to one of our Customer Care Consultants.

Toll Free: 0800 FP CARE or 0800 372 273

Fax: (09) 273 0656

Website: fisherpaykel.com

Postal address: Fisher & Paykel Appliances Ltd, PO Box 58550, Botany, Auckland 2163

If you need service...*

Fisher & Paykel has a network of Fisher & Paykel trained and supported service technicians that can carry out any service necessary on your appliance. Our Customer Care Centre can recommend a Fisher & Paykel trained and supported service technician in your area.

In Australia if you need assistance...*

Call the Fisher & Paykel Customer Care Centre and talk to one of our Customer Care Consultants.

Toll Free: 1300 650 590

Fax: (07) 3826 9298

Website: fisherpaykel.com

Postal address: Fisher & Paykel Appliances Australia Pty Ltd, PO Box 798, Cleveland QLD 4163

If you need service...*

Fisher & Paykel has a network of Fisher & Paykel trained and supported service technicians that can carry out any service necessary on your appliance. Our Customer Care Centre can recommend a Fisher & Paykel trained and supported service technician in your area.

*If you call, write or contact us via our website please provide:

your name and address, model number, serial number, date of purchase and a complete description of the problem. This information is needed in order to better respond to your request for assistance.

Product details can be found on the rear of the machine, and/or on the inside of the door below the glass (when the door is open).

CUSTOMER CARE

Registration

Register your product with us so we can provide you with the best service possible.
To register your product visit our website: fisherpaykel.com

Complete and keep for safe reference:

Model _____

Serial No. _____

Purchase Date _____

Purchaser _____

Dealer _____

Suburb _____

Town _____

Country _____

FISHERPAYKEL.COM

© Fisher & Paykel Appliances 2019. All rights reserved.

The product specifications in this document apply to the specific products and models described at the date of issue. Under our policy of continuous product improvement, these specifications may change at any time. You should therefore check with your Dealer to ensure this document correctly describes the product currently available.

NZ AU

428104F 09.19