

OUTLET

Installation and Operating Instructions

Model:

FS600SC
FS600BC

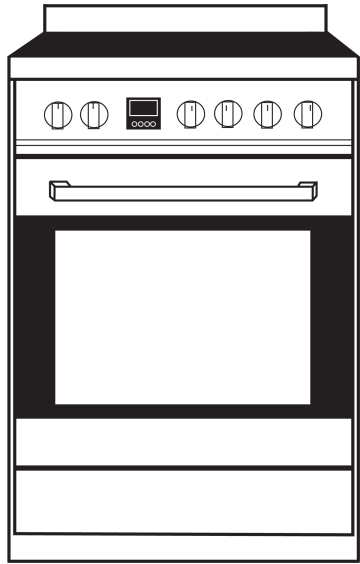

As part of Parmco Appliances commitment to improving and updating product ranges, we reserve the right to alter, change and update technical specifications and appearance attributes of all Parmco Appliances products. E&OE 727626082022

PARMCO

Inspiring kitchens, entertaining homes

p: 09 573 5678
f: 09 573 5699
e: sales@parmco.co.nz
w: www.parmco.co.nz



*Parmco Appliances
extended 7 year
warranty*

The Warranty:

- This appliance is intended for domestic use in the owners' home. Use of the appliance for commercial purposes will limit the warranty period (please see Parmco website for commercial details).
- Subject to the terms and conditions contained within this warranty, if the product is not of Acceptable Quality (as defined in the Consumer Guarantees Act) within 7 years of the date of original purchase, then Parmco Sales undertakes to repair or, at its sole discretion, replace the product.
- The warranty does not cover the costs of transport, mileage or travelling time if the product is located beyond 30km of a recognised Service Agent.
- This warranty is offered as an extra benefit, and does not affect other legal rights, which can not be modified or excluded by agreement.
- This warranty only applies to goods supplied and installed in the North and South Islands of New Zealand.
- The provisions of this warranty are in addition to the rights and remedies available to consumers under the Consumer Guarantees Act 1993.

Product _____ Date of purchase _____
 Serial Number _____
 Dealer / Retailers Name _____

 Please retain this Warranty card together with receipt or other proof of purchase date when seeking service during the warranty period

Please contact Parmco at 09 573 5678 if your appliance needs servicing under warranty. Please have your model number and proof of purchase ready. Warranty repairs must be authorized by Parmco.

Subject to updates without prior notice, please visit www.parmco.co.nz for the latest version.

The Warranty is not valid:

- If the product is not installed and operated in accordance with the operating instructions.
- If the product is not installed to comply with the electrical, gas, plumbing and other Regulations and Codes of Practice in New Zealand.
- If the product is operated on voltages or frequencies outside the normal range for domestic appliances in New Zealand.
- If the product is not used in normal domestic use, or if it is used in a business as defined in the Consumer Guarantees Act.
- If any serial number has been removed or defaced.
- If proof of date of purchase is not supplied, except at the sole discretion of Parmco Sales. Proof of purchase can be for the product itself, or if installed with a kitchen or house then proof of purchase can be from a Parmco reseller of products supplied by Parmco.
- If the products are purchased in a second hand condition from other parties (including but not limited to TradeMe, Sella, etc.)

Liability under this warranty will not be accepted for:

- Wear and tear caused by normal domestic use of the product.
- Damage in transport.
- Damage caused to the product by neglect, abuse, negligence, wilful act or misuse.
- Any costs associated with the repair, replacement, removal or reinstallation of products installed in a damaged condition.
- Any defect caused by accident, misuse, neglect, tampering with or unauthorised modifications of the appliance or any attempt at internal adjustment or repair by any person other than an Authorised Service Agent.
- Service calls that relate principally to the following:
 - Instruction on how to use the product.
 - Repair or replacement of house fuses, electrical wiring, gas fitting or plumbing.
 - Normal or scheduled maintenance including blocked filters or ducting.
 - Consumable items such as light bulbs.
 - Any damage to hobs caused by spills when cooking.
 - Any breakage or damage of glass items.
 - Any damage caused by non recommended product used for cleaning, maintaining, lubricating or similar.
 - Any aspect relating to the installation of the product, or damage caused during installation including blocked access for repair.
 - Any third party (including reseller) or consequential loss or damage (direct or indirect) however arising.



Dear Valued Customer,

Thank you and congratulations on purchasing your new Parmco appliance.

All Parmco products are made to the highest quality and design standards. We are sure you will enjoy your new appliance.

As a note, please read through these instructions carefully. These will assist you in gaining a complete understanding of the functions and features offered by your appliance. Please take special note of all detailed technical information and installation instructions. It is essential that you follow these instructions to ensure the safety and reliability of this appliance.

Furthermore, not using appropriate personnel to install this appliance may affect any future warranty claims lodged, so please check with Parmco Appliances before any installation is carried out.

We hope you enjoy your new appliance. If you would like to find out more about this product or any other products in Parmco's extensive range, visit us online at www.parmco.co.nz.

The Parmco Team

PARMCO

Inspiring kitchens, entertaining homes

TABLE OF CONTENTS

Safety instructions.....	4
How to save energy.....	5
Unpacking.....	6
Disposal of the appliance.....	6
Installation.....	8
Operation.....	10
Before first use	10
Controlling the heating zones of the ceramic hob	10
Electronic programmer.....	11
Oven functions and operation.....	17
Cleaning and maintenance.....	20
Operation in case of emergency.....	21
Baking in the oven.....	22
Technical information.....	28

SAFETY INSTRUCTIONS

- The appliance becomes hot during operation. Take care not to touch the hot parts inside the oven.
- Always keep children away from the cooker. While in operation direct contact with the cooker may cause burns!
- Ensure that small items of household equipment, including connection leads, do not touch the hot oven or the hob as the insulation material of this equipment is usually not resistant to high temperatures.
- Do not leave the cooker unattended when frying. Oils and fats may catch fire due to overheating.
- Do not allow the cooktop to get soiled and prevent liquids from boiling over onto the surface of the cooktop, Any spillages should be cleaned up as they happen.
- Do not place pans with a wet bottom on the warmed up heating zones as this can cause irreversible changes to the cooktop (irremovable stains).
- Do not switch on the cooktop until a pan has been placed on it.
- Do not put pans weighing over 15kg on the opened door of the oven and pans over 25kg on the cooktop.
- Do not use harsh cleaning agents or sharp metal objects to clean the doors as they can scratch the surface, which could then result in the glass cracking.
- Do not use the cooker in the event of a technical fault. Any faults must be fixed by an appropriately qualified and authorized person.
- In the event of any incident caused by a technical fault, disconnect the power and report the fault to the service centre to be repaired.
- The rules and provisions contained in this instruction manual should be strictly observed. Do not allow anybody who is not familiar with the contents of this instruction manual to operate the cooker.
- The cooker should not be cleaned using steam equipment.
- **WARNING:** In order to prevent accidental tipping of the appliance, for example by a child climbing onto the open door, the stabilizing means must be installed.
- The oven must be switched off before removing the guard and that, after cleaning, the guard must be replaced in accordance with the instructions.
- Ensure that the appliance is switched off before replacing the lamp to avoid the possibility of electric shock.
- **WARNING:** Accessible parts will become hot when the grill is in use. Children should be kept away.
- The appliance is not intended to be operated by means of an external timer or separate remote-control system.
- This appliance is not intended for use by persons (including children) with reduced physical, sensory or mental capabilities, or lack of experience and knowledge, unless they have been given supervision or instruction concerning use of the appliance by a person responsible for their safety.
- Children should be supervised to ensure that they do not play with the appliance.
- If the supply cord is damaged, it must be replaced by the manufacturer or its service agent or a similarly qualified person in order to avoid a hazard.
- Use pans that are specified by the manufacturer as designed for use with a ceramic hob.
- If the surface is cracked, switch off the appliance to avoid the possibility of electric shock.

SAFETY INSTRUCTIONS

Do not use pans with sharp edges that may cause damage to the ceramic hob. Do not look directly at the halogen heating zone (not covered with a pan) when they are warming up.

For long cooking times, switch off heating zones 5 to 10 minutes before finishing cooking. This saves up to 20% on energy.

- Only use the oven when cooking larger dishes. Meat of up to 1 kg can be prepared more economically in a pan on the cooker burner.
- Make use of residual heat from the oven.

If the cooking time is greater than 40 minutes it is recommended to switch off the oven 10 minutes before the end time.

Caution !

When using the timer set appropriately shorter cooking times according to the dish being prepared.

- Only grill with the ultrafan after closing the oven door.
- Make sure the oven door is properly closed. Heat can leak through spillages on the door seals. Clean up any spillages immediately.
- Do not install the cooker in the direct vicinity of refrigerators/freezers. Otherwise energy consumption increases unnecessarily.

HOW TO SAVE ENERGY



Using energy in a responsible way not only saves money but also helps the environment. So let's save energy! And this is how you can do it:

- Use proper pans for cooking. Pans with thick, flat bases can save up to 1/3 on electric energy. Remember to cover pans if possible otherwise you will use four times as much energy!
- Match the size of the saucepan to the surface of the heating plates. A saucepan should never be smaller than a heating plate.
- Ensure heating plates and pan bases are clean. Soils can prevent heat transfer and repeatedly burnt-on spillages can often be removed by products which cause damage to the environment.
- Do not uncover the pan too often (a watched pot never boils!). Do not open the cover door unnecessarily often.
- Switch off the oven in good time and make use of residual heat.

UNPACKING



During transportation, protective packaging was used to protect the appliance against any damage.

After unpacking, please dispose of all elements of packaging in a way that will not cause damage to the environment. All materials used for packaging the appliance are environmentally friendly; they are 100% recyclable and are marked with the appropriate symbol.

Caution!

During unpacking, the packaging materials (polythene bags, polystyrene pieces, etc.) should be kept out of reach of children.

DISPOSAL OF THE APPLIANCE



Old appliances should not simply be disposed of with normal household waste, but should be delivered to a collection and recycling centre for electric and electronic equipment.

A symbol shown on the product, the instruction manual or the packaging shows that it is suitable for recycling.

Materials used inside the appliance are recyclable and are labeled with information concerning this. By recycling materials or other parts from used devices you are making a significant contribution to the protection of our environment.

Information on appropriate disposal centers for used devices can be provided by your local authority.

DESCRIPTION OF THE APPLIANCE

Control panel

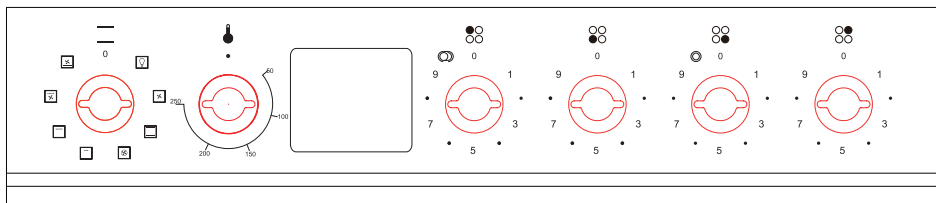

DESCRIPTION OF THE APPLIANCE

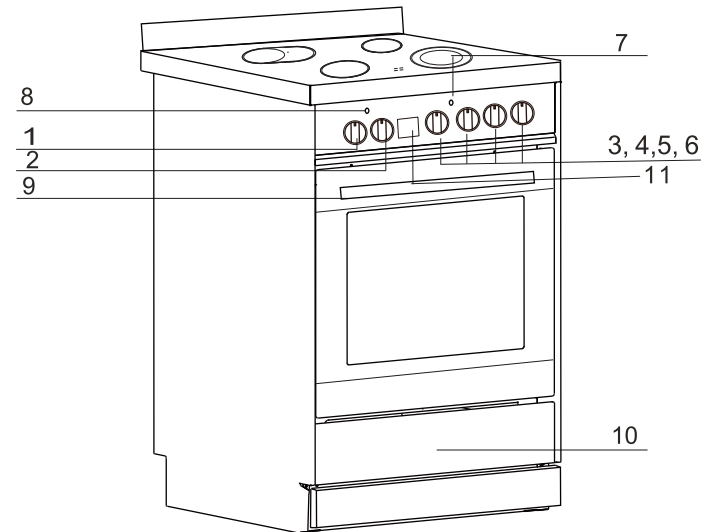

- 1 Oven function control knob
- 2 Temperature control knob
- 3,4,5,6 Heating zone control knobs
- 7 Cooker operation indicator
- 8 Oven operation indicator
- 9 Oven door handle
- 10 Drawer
- 11 Electronic programmer

INSTALLATION

Installing the cooker

- The kitchen should be dry and airy and have effective ventilation according to the existing technical provisions.
- The room should be equipped with a ventilation system that pipes away exhaust fumes created during combustion. This system should consist of a ventilation grid or hood. Hoods should be installed according to the manufacturer's instructions. The cooker should be placed so as to ensure free access to control elements.
- Coating or veneer used on fitted furniture must be applied with a heat resistant adhesive (100°C). This prevents surface deformation or detachment of the coating. If you are unsure of your furniture's heat resistance, you should leave approximately 2 cm of free space around the cooker. The wall behind the cooker should be resistant to high temperatures. During operation, its back side can warm up to around 50°C above the ambient temperature.

Fix the cooker to the back wall with 2 chains

Anti tilt chains are located at the rear of the appliance and must be secured to the wall behind the appliance to prevent accidental tipping/tilting. The chain length must be as short as practicable to avoid appliance tilting forward and also diagonal to avoid appliance moving sideways.

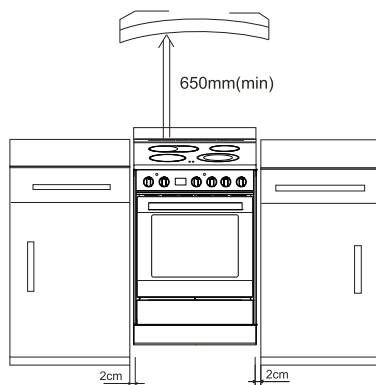

- The cooker should stand on a hard, even floor (do not put it on a base.)

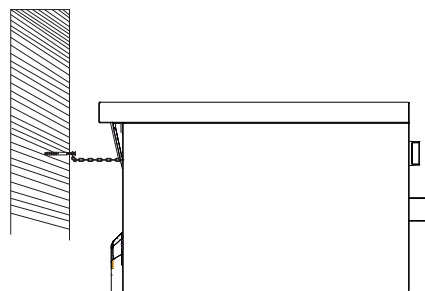

INSTALLATION

- Before you start using the cooker it should be leveled, which is particularly important for fat distribution in a frying pan. To this purpose, adjustable feet are accessible after removal of the drawer. The adjustment range is +/-5mm.

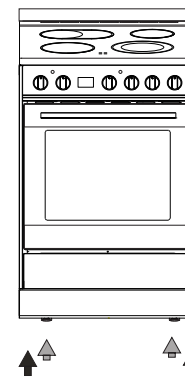

OPERATION

Before first use

- Remove packaging and empty the drawer. Clean the interior of the oven with warm soapy water and wipe clean with moistened cloth or sponge. Wipe clean the cooktop.
- Take out and wash the oven fittings with warm water and a little washing-up liquid.
- Switch on the ventilation in the room or open a window.
- Heat the oven (to a temperature of 250, for approx. 30 min.), remove any stains and wash carefully. The hotplates should be heated for around 4 minutes without a pan or pot on them.
- When heating the oven or the first time it is normal for the stove to give off smoke and manufacturing odours. These will disappear after about 30 Minutes.

Controlling the heating zones of the ceramic hob

Choice of cookware

Choose a pan with a diameter that is at least as large as the heating zone. Do not use pans with a concave and convex base. Always remember to put a proper cover on the pan. We recommend the use of pans with thick, even bases.

If the heating zones and pans are soiled it is impossible to make full use of the heat.



Heat level selection

The heating zones have different levels of heat. The level of heat can be adjusted gradually by turning the appropriate knob to the right or left. The knob are unfold on the control panel, to select it you should:

- push the knob gently and then turn it;
- set it to the right position.

The marks at the knob show the different levels reached by the heating zones.

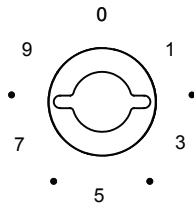

Step	Suitable for
0	hot plate off, use of remaining heat
1-2	maintaining temperature, slow cooking, small quantities of food (min power)
3	slow cooking
4-5	slow cooking of large quantities, slow frying of large big chunks
6	frying, preparing soup basis
7-8	fry
9	boiling, browning, frying (maximum power)

OPERATION

Zone heating indicator

If the temperature of a heating zone exceeds 65 degree this is signalled by an indicator which lights up for that zone.

When the heating indicator lights up it warns the person using the cooker against touching a hot heating zone.

For about 5 to 10 minutes after a heating zone is switched off it will still have residual heat that can be used, for example to warm up or keep dishes warm without switching on another heating zone.

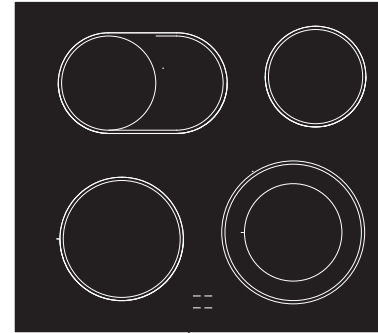

Zone heating indicator

OPERATION

▶ Electronic programmer

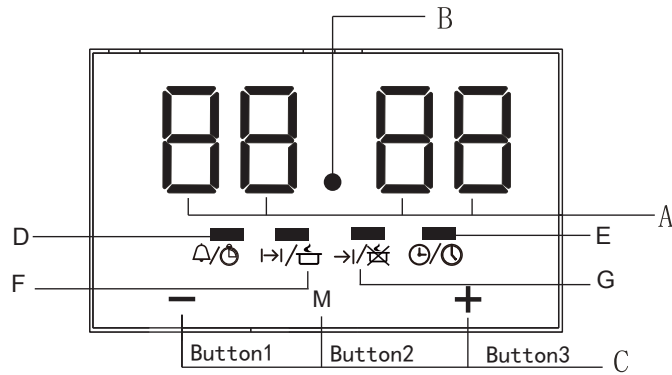

A - Display field

B - Seconds Icon

C - Buttons

D - Timer

E - Current time

F - Cooking time

G - End of cooking time

M - Function

— - To decrease the numbers on the digital display

⊕ - To increase the numbers on the digital display

OPERATION

Setting the time

- At power on, displayed "12.00", and flashes.



- The current time can be set with button 1 and 3, 5 seconds after the time has been set, the new data will be saved.

- 5 seconds after the time is set, or directly press the button 2, the signal function is on, your setting is saved.

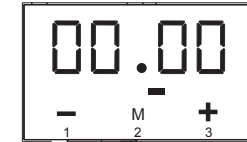

- When the set time is up the alarm signal will be activated and the signal function starts flashing again.

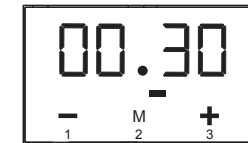

Timer

The timer can be activated at any time and any function. The timer can be set from 1 minute to 23 hours and 59 minutes.

To set the timer you should:

- Press button 2, flashing . Enter the timer setting.



- Set the timer using buttons 1 and 3.

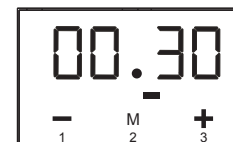

- Press any button, the signal function and alarm signal will go off. Or the alarm signal will be turned off automatically after 2 minutes.

OPERATION

Caution!

Besides timer alarm, any other alarms can be turned off by pressing any button. If the alarm signal is not turned off manually, it will be turned off automatically after 2 minutes.

Semi-automatic operation

If the oven is to be switched off at a given time, or after defined period, you should:

1. Set the oven function knob and the temperature regulator knob to the setting at which you want the oven to operate.
2. Press the function button, the oven will begin to work and the function signal $\rightarrow|$ flashing.
3. Press button 1 or 3 to adjust the cooking time, within a range from 1 minute to 10 hours.
4. Or press button "M" twice. then the display will show flashing $\rightarrow|$. Set the end time by buttons 1 and 3.
5. The set time is introduced to the memory after 5 seconds.
6. When the set time passed, the oven is switched off automatically, the alarm is activated.
7. Press any button, the alarm signal and the $\rightarrow|$ icon will go off, Or the alarm signal will be turned off automatically after 2 minutes.

Caution!

- When using the semi-automatic operation, set either the cooking time or the end of cooking time.
- If you set the cooking time to 0 or set the end of cooking time to the current time, the auto function will be off.
- After the auto function be off, the cooking time to 0, end of cooking time and current time remains the same.

For example:

The current time is 2:00, want to oven work of 3 hours, end of cooking time is set to be 5:00 ($2:00+3:00 = 5:00$).

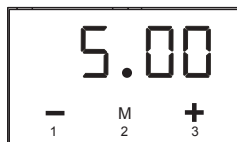

There are two methods to achieve this setting:

First method:

1. Set the cooking time using buttons 1 and 3.

OPERATION

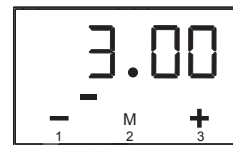

2. End of cooking time automatically change to 5:00.

Second method:

1. Set the end of cooking time using buttons 1 and 3.

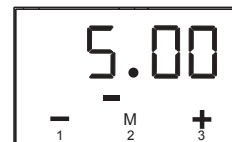

2. Cooking time automatically change to 3:00. 5 seconds after the setting, the auto function is on. 3 hours later, the current time shows "5.00" The alarm signal is activated.

Automatic operation

If the oven is to be switched on for a specified period of time and switched off at a fixed hour then you should set the cooking time and the end of cooking time:

1. Set the oven function knob and the temperature regulator knob to the setting at which you want the oven to operate.
2. Press button 2, the oven will begin to work and the function signal $\rightarrow|$ flashing.
3. Press button 1 or 3 to adjust the cook time, within a range from 1 minute to 10 hours.
4. And press button 2. then the display will show flashing $\rightarrow|$. Set the cooking time using buttons 1 and 3.
5. The set time is introduced to the memory after 5 seconds, the $\rightarrow|$ and $\rightarrow|$ always on.
6. When the set time passed, the oven is switched off automatically, the alarm is activated. and the $\rightarrow|$ will go off.
7. Press any button, the alarm signal and the $\rightarrow|$ icon will go off, Or the alarm signal will be turned off automatically after 2 minutes.

OPERATION

Caution!

For example:

If the current time is 2:00; cooking time set to be 3 hours ; end of cooking time set to be 10:00, the work time will be 7:00 (7:00=10:00-3:00).

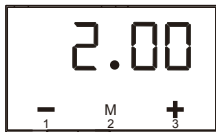

1. Set the cooking time to be "3.00" with buttons 1 and 3.

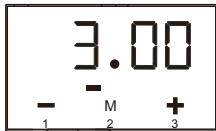

2. Set the end of cooking time. time to be "10.00" with buttons 1 and 3.

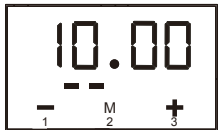

3. 5 seconds after setting, the auto function is on.

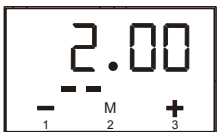

4. When it up to 7:00 , the oven will begin to work .

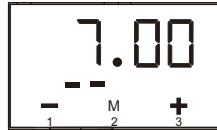

5. When it up to 10:00 , the alarm signal is activated. The oven is switched off automatically.

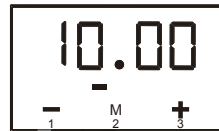

Caution!

- At least more than one minute cooking time, cooking time and end of cooking time must be set.
- If the cooking time set to be 0 or the end of cooking time set to be the current time, the auto function will be off.
- After the auto function be off, the cooking time to 0, end of cooking time and current time remains the same.

The cooking time、 waiting time and end of cooking time range:

Cooking time range: $0 < t \leq 10$ hours

End of cooking time range: current time $<$ end of cooking time \leq current time + waiting time + cooking time

Waiting time = end of cooking time - cooking time.

OPERATION

Oven

Oven is controlled by the function knob and the temperature control knob.

Caution!

When selecting any heating function the oven will be switched on only after the temperature has been set by the temperature control knob.

Possible settings of the oven function knob



Static Grill

When the "combined grill" is active it enables grilling with the grill and with the top heater switched on at the same time.

This function allows a higher temperature at the top of the cooking area, which cause more intense browning of the dish and permits larger portions to be grilled.

Warning!

When using function grill it is recommended that the oven door is closed.

When the grill is in use accessible parts can become hot. it is best to keep children away from the oven.



Defrost

This function for defrosting

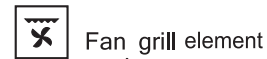

Fan , grill element

When the knob is turned to this position, the oven activates the grill and fan function. In practice, this function allows the grilling process to be speeded up and an improvement in the taste of the dish , you should only use the grill with the oven door shut.



Bottom and top element on

Setting the knob to this position allows the oven to be heated conventionally.

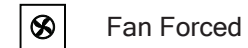

Fan Forced

At this function, allows the oven to be heating up in a forced way with the thermofan, which is in the central part of the oven heating method is: Reduction of oven heating-up time and of the initial heating stage. Possibility to bake at two cooking levels simultaneously.



Fan and bottom heater on

At this oven function , the oven activates the bottom heater and fan function. The mode is useful for baking low pastry and preparation of preserved fruit and vegetables.



Grill heater on

Setting the knob to this position allows dishes to be grilled on the grate.

Warning!

When using function grill it is recommended that the oven door is closed.

When the grill is in use accessible parts can become hot.

It is best to keep children away from the oven.

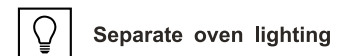

Separate oven lighting

By setting the knob to this position the lighting inside the oven is switched on

OPERATION

▷ Changing the Oven Lamp

Before any maintenance is started involving electrical parts, the appliance must be disconnected from the power supply. If the oven has been in use, let the oven cavity and the heating elements cool down before attempting any maintenance.

Changing the bulb

- Unscrew the protective cover. We recommend that you wash and dry the glass cover at this point.
- Carefully remove the old bulb and insert the new bulb suitable for high temperatures (300°C) having the following specifications: 220-240V, 50Hz, 25W, G9 fitting.
- Refit the protective cover.

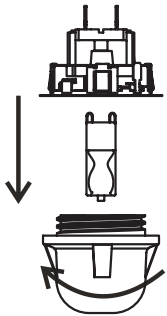

IMPORTANT

Never use screwdrivers or other utensils to remove the light cover. This could damage the enamel of the oven or the lampholder. Remove only by hand.

IMPORTANT

Never replace the bulb with bare hands as contamination from your fingers can cause premature failure. Always use a clean cloth or gloves.

Please note:

The bulb replacement is not covered by your guarantee

OPERATION

Use of the grill

The grilling process operates through infrared rays emitted onto the dish by the incandescent grill heater.

In order to switch on the grill you need to:

- Set the oven knob to the position marked grill.
- Heat the oven for approx. 5 minutes (with the oven door shut).
- Insert a tray with a dish onto the appropriate cooking level; and if you are grilling on the grate insert a tray for dripping on the level immediately below (under the grate).
- Close the oven door.

For grilling with the function grill and combined grill the temperature must be set to 250°C, but for the function fan and grill it must be set to a maximum of 200°C.

Warning!

When using grill function it is recommended that the oven door is closed.

When the grill is in use accessible parts can become hot.

It is best to keep children away from the oven.

Oven guide levels

Baking pans and accessories (oven grid, baking tray, etc) may be inserted into the oven in 6 guiding levels.

Appropriate levels are indicated in the tables that follow.

Always count levels from the bottom upwards!

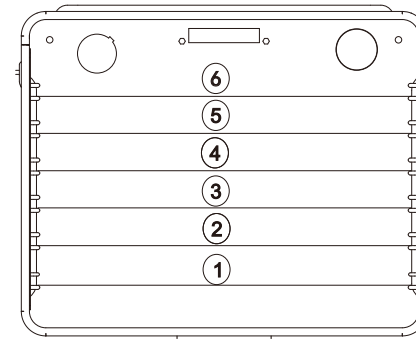

CLEANING AND MAINTENANCE

By ensuring proper cleaning and maintenance of your oven, you can have a significant influence on the continuing fault-free operation of your appliance.

Before you start cleaning, the oven must be switched off and you should ensure that all knobs are set to the "0" position. Do not start cleaning until the oven has completely cooled.

▷ Oven

- The oven should be cleaned after each use.
- Cool the oven completely before cleaning.
- Never clean the appliance with pressurised hot steam cleaner!
- The oven chamber should only be washed with warm water and a small amount of washing-up liquid.
- Steam cleaning
 - pour 250ml of water (1 cup) into a bowl placed in the oven on the first level from the bottom.
 - Close the oven door,
 - Set the temperature knob to 100°C, and the function knob to the bottom heater position,
 - heat the oven chamber for approximately 30 minutes,
 - Open the oven door, wipe the chamber inside with a cloth or sponge and wash using warm water with washing-up liquid.
- After cleaning the oven chamber wipe it dry.

Caution !

Do not use cleaning products containing abrasive materials for the cleaning and maintenance of the glass front panel.

- When cleaning do not use cleaning agents with a strong abrasive effect, such as e.g. scouring powders containing an abrasive, abrasive compounds, abrasive stones, pumice stones, wire brushes and so on. They may scratch the hob surface, causing irreversible damage.
- Large spillages that are firmly stuck to the hob can be removed by a special scraper; but be careful not to damage the ceramic hob frame when doing this.

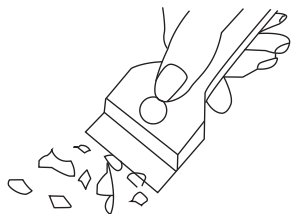

Scraper for cleaning the hob

Caution !

The sharp blade should always be protected by adjusting the cover (just push it with your thumb). Injuries are possible so be careful when using this instrument—keep out of reach of children.

- Appropriate light cleaning or washing products are recommended, such as e.g. any kind of liquids emulsions for fat removal. Alternatively a solution of warm water with a little washing-up liquid or cleaning products for stainless steel sinks can be used.

CLEANING AND MAINTENANCE

▷ Door removal

In order to obtain easier access to the oven chamber for cleaning, it is possible to remove the door.

To do this, tilt the safety catch part of the hinge upwards. Close the door lightly, lift and pull it out towards you. In order to fit the door back on to the cooker, do the reverse. When fitting, ensure that the notch of the hinge is correctly placed on the protrusion of the hinge holder. After the door is fitted to the oven, the safety catch should be carefully lowered down again. If the safety catch is not set it may cause damage to the hinge when closing the door.

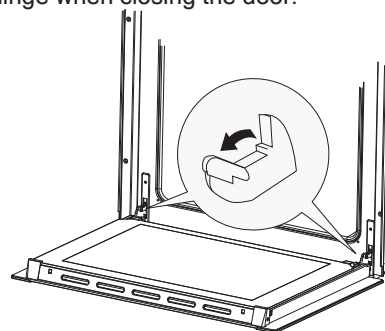

Tilting the hinge safety catches

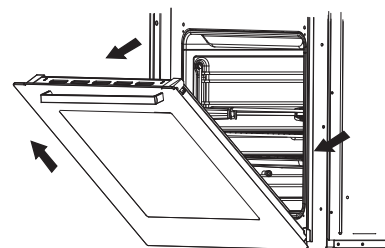

Door removal

▷ Removal of the internal glass panel

Unscrew and unfasten the plastic latch that is in the corner at the top of the door. Next take out the glass from the second blocking mechanism and remove. After cleaning, insert and block the glass panel, and screw in the blocking mechanism.

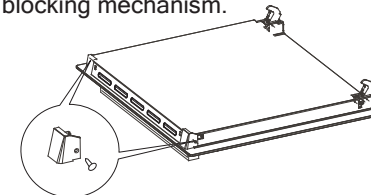

Removal of the internal glass panel

▷ Install door

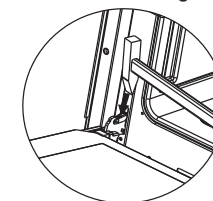

▷ Regular inspections

Besides keeping the cooker clean, you should:

- Carry out periodic inspections of the control elements and cooking units of the cooker. After the guarantee has expired you should have a technical inspection of the cooker carried out at a service centre at least once every two years.
- Fix any operational faults.
- Carry out periodical maintenance of the cooking units of the cooker.

Caution !

All repairs and regulatory activities should be carried out by the appropriate service centre or by an appropriately authorized fitter.

OPERATION IN CASE OF EMERGENCY

In the event of an emergency, you should:

- switch off all working units of the oven

BAKING IN THE OVEN

- disconnect the mains plug
- call the service centre
- some minor faults can be fixed by referring to the instructions given in the table below. Before calling the customer support centre or the service centre check the following points that are presented in the table.

PROBLEM	REASON	ACTION
1. The appliance does not work.	Break in power supply.	Check the household fuse box; if there is a blown fuse replace it with a new one.
2. The programmer display is flashing "0.00".	The appliance was disconnected from the mains or there was a temporary power cut.	Set the current time (see Use of the programmer).
3. The oven lighting does not work.	The bulb is loose or damaged.	Tighten up or replace the blown bulb(see Cleaning and Maintenance)

▷ Baking cakes and loaves

Warning!

- The baking parameters given in Tables are approximate and can be corrected based on your own experience and cooking preferences.
- In case you may not find any particular type of cake in the tables, use the information available for the next most similar type of cake.

Baking with upper and lower heaters

- Use only a single guide level.
- This baking position is especially suitable for baking dry pastry, bread and teacakes. Use dark baking pans. Light pans reflect heat and pastry is not adequately browned.
- Always place baking pans on the grid rack. Remove the grid only of baking in the flat biscuit tray, supplied with the appliance.
- Preheating shortens the baking time. Do not put the cake in the oven until proper temperature is obtained. gradually by turning the appropriate knob to the right or left. The knob is unfold on

Baking tips

Is cake cooked?

Pierce the cake with a wooden peg at the thickest part, if the dough does not stick to it, the cake is baked. You may switch off the oven and use the remaining heat.

cake has fallen

Check the recipe. Use less fluid next time. Follow the mixing times, especially when using powered kitchen mixers.

cake is too light on the bottom

Use dark baking pan next time, or place the pan one level lower, or switch on the lower heater a while before the completion.

Cheese cake is undercooked



Next time reduce the baking temperature and extend the baking time.

Warnings regarding the baking tables

- The tables indicate the temperature range. Always select lower temperature first. You may always increase the temperature in case pastry needs more baking.
- Baking times are indicative only. They may vary in dependence of individual characteristics.
- The asterisk indicates that the oven requires preheating.

BAKING IN THE OVEN

Baking Table is for cakes and loaves

Type of pastry	Guide level (from down upwards)	Temp(°C) 	Guide level (from down upwards)	Temp(°C) 	Baking time (in min.)
Sweet pastry					
Raisin cake	2	160-170	2	150-160	55-70
Ring cake	2	160-170	2	150-160	60-70
Tree cake (tart form)	2	160-170	2	150-160	45-60
Cheese cake (tart form)	2	180-190	3	160-170	60-80
Fruit cake	2	190-200	3	170-180	50-70
Fruit cake with icing	2	180-190	3	160-170	60-70
Sponge cake	2	180-190	2	160-170	30-40
Flake cake	3	190-200	3	170-180	25-35
Fruit cake mix dough	3	180-190	3	160-170	50-70
Cherry cake	3	190-210	3	170-200	30-50
Jelly roll	3	190-200	3	170-180	15-25
Fruit fan	3	160-170	3	150-160	25-35
Plait bun	2	190-210	3	180-210	35-50
Christmas cake	2	180-190	3	170-200	45-70
Apple pie	2	190-210	3	170-200	40-60
Puff paste	2	180-190	3	160-170	40-60
Salted pastry					
Bacon roll	2	190-200	3	170-180	45-60
Pizza	2	220-240	3	210-230	30-45
Bread	2	200-220	3	180-210	50-60
Rolls	2	210-230	3	200-220	30-40
Cookies					
Caraway roll	3	180-190	3	160-170	15-25
Biscuits	3	180-190	3	160-170	20-30
Danish pastry	3	190-210	3	170-200	20-35
Flaky pastry	3	200-210	3	180-200	20-30
Cream puff	3	190-210	3	170-200	25-45
Deep frozen pastry					
Apple pie, cheese pie	2	190-210	3	170-200	50-70
Cheese cake	2	190-200	3	170-180	65-85
Pizza	2	210-230	3	200-220	20-30
Chips for oven	2	210-230	3	200-220	20-35
Potato fries for	2	210-230	3	200-220	20-35

BAKING IN THE OVEN

▷ Roasting

Best heating mode for each type of roasting pan is indicated by bold print in the Roasting Tables.

Tips regarding roasting pans

- Use light enamel pans, temperature resistant glass pans, clay dishes or wrought iron dishes.
- Stainless steel dishes are not recommendable because they excessively reflect heat.
- Cover your roast or wrap it in foil. It will preserve its juice and the oven will remain cleaner.
- If you leave the pan uncovered the roast will be cooked sooner. Roast large chunks of meat directly on the grid, with intercepting pan underneath.



Attention when roasting !

Roasting tables indicate suggested temperatures, guide levels and roasting times. Roast time largely depends upon the type of meat, its size and quality. So you may expect some variations.

- Roasting of large chunks of meat may produce excessive steaming and dew formation at the oven door. This is quite normal, and does not affect the operation of the oven. However, after the completion of roasting wipe the oven door and the glass thoroughly.
- Roasting of red meat, poultry and fish is rational if the roast exceeds one kilogram in size.
- Add as much liquid as necessary to prevent burning of juice, dripping from meat. Roast must be surveyed at all times. And liquid added if necessary.
- At approximately the middle of the indicated time turn the roast round, especially if you use the deep roast dish.
- When roasting on the grill grid, place the grid in the deep roasting pan and insert both into the sliding guide. The bottom pan will intercept dripping fat.
- Never leave roast to cool in the oven, as it might produce dew and corrosion of the oven.

BAKING IN THE OVEN

Roasting table

Type of meat	Weight (in grams)	Shelf position (from down upwards)	Temp (°C) 	Roasting time (in min.)	Temp (°C) 	Roasting time (in min.)
Beef						
Beef loin	1000	2	210-230	100-120	200-220	100-120
Beef loin	1500	2	210-230	120-150	200-220	120-150
Roast beef, rare	1000	2	230-240	30-40	220-230	30-40
Roast beef, well done	1000	2	230-240	40-50	220-230	40-50
Pork						
Pork roast with skin	1500	2	190-200	140-160	170-180	140-160
Flank	1500	2	200-210	120-150	180-190	120-150
Flank	2000	2	190-210	150-180	170-200	150-180
Pork loin	1500	2	210-230	120-140	200-220	120-140
Meat roll	1500	2	210-230	120-140	200-220	120-140
Pork outlet	1500	2	190-210	100-120	170-200	100-120
Minced meat roast	1500	2	220-230	60-70	210-220	60-70
Veal						
Veal roll	1500	2	190-210	90-120	170-200	90-120
Veal knuckle	1700	2	190-210	120-130	170-200	120-130
Lamb						
Lamb prime ribs	1500	2	200-210	100-120	180-200	100-120
Mutton blade bone	1500	2	200-210	120-130	180-200	120-130
Ham	1500	2	200-220	100-120	180-210	100-120
Poultry						
Chicken entire	1200	2	210-220	60-70	200-210	60-70
Hen	1500	2	210-220	70-90	200-210	70-90
Duck	1700	2	190-210	120-150	170-200	120-150
Goose	4000	2	170-180	180-200	150-160	180-200
Turkey	5000	2	160-170	180-240	140-150	180-240
Fish						
Fish, entire	1000	2	210-220	50-60	200-210	50-60
Fish soufflé	1500	2	190-210	50-70	170-200	50-70

BAKING IN THE OVEN

BAKING IN THE OVEN

▷ Grilling

- Take extra precautions when grilling. Intensive heat from infrared heater makes the oven and the accessories extremely hot. Use protective gloves and barbecue accessories!
- Perforated roast may produce spurting of hot grease(sausages). Use long grill tongs to prevent skin burns and protect your eyes.
- Supervise the grill at all time. Excessive heat may quickly burn your food and provoke fire!
- Do not let the children in the vicinity of the grill.

Grill heater is especially suitable for the preparation of low-fat sausages, meat and fish fillets and steaks, and for browning and crisping the roast skin.

Tips for grilling

- Grilling should be carried out with the oven door closed.
- Grilling tables indicate the recommended temperature, guide levels and grilling times, which may vary according to the weight and quality of meat.
- Grill heater should be pre-heated for 3 minutes.
- Oil the grill grid before placing the food, otherwise food might stick to the grid.
- Place the meat upon the grid, then place the grid upon the grease interception pan. Insert both trays into the oven guides.
- Turn the meat round after half of the roasting time has expired. Thinner slices will require only one turn, for larger chunks you might need to repeat the procedure. Always use barbecue tongs to avoid losing excessive juice from meat.
- Dark beef meat is grilled quicker than lighter pork or veal.
- Clean the grill, the oven and the accessories each time after use.

BAKING IN THE OVEN

Grill table

Type of meat for grill	Weight (in grams)	Shelf position (from bottom up)	Temp (°C)	Grill time (in min.)
Meat and sausages				
2 beefsteaks, rare	400	5	240	14-16
2 beefsteaks, medium	400	5	240	16-20
2 beefsteaks, well done	400	5	240	20-23
2 pork scrag fillets	350	5	240	19-23
2 pork chops	400	5	240	20-23
2 veal steaks	700	5	240	19-22
4 lamb cutlets	700	5	240	15-18
4 grill sausages	400	5	240	9-14
2 slices of meat cheese	400	5	240	9-13
1 chicken, halved	1400	3	240-250	28-33(1.side) 23-28(2.side.)
Fish				
Salmon fillets	400	4	240	19-22
Fish in aluminium foil	500	4	230	10-13
Toast				
4 slices of white bread	200	5	240	1,5-3
2 slices of whole meal	200	5	240	2-3
Toast sandwich	600	5	240	4-7
Meat/poultry				
Chicken	1000	3	180-200	60-70
Pork roast	1500	3	160-180	90-120
Pork scrag	1500	3	160-180	100-180
Pork knuckle	1000	3	160-180	120-160
Roast beef/ beef fillet	1500	3	190-200	40-80

TECHNICAL INFORMATION

TYPE	FS600SC FS600BC
Dimensions (height/width/depth) mm	900/595/595
Cooktop	
180mm Hilight heater(kW)	1.8
145mm Hilight heater(kW)	1.2
230mm Hilight heater(kW)	2.2
165*270mm Hilight heater(kW)	2.0
Oven	
Guide levels	6
Rear heater(kW)	1.6
Top heater(kW)	0.85
Bottom heater(kW)	1.15
Grill heater(kW)	1.1
Oven illumination(W)	25
Function modes	
Oven light(W)	25
Top+bottom heater(kW)	2.0
Fan(W)	30
Fan+Rear heater(kW)	1.6
Fan+Bottom heater(kW)	1.15
Half grill(kW)	1.1
Top heater+grill(kW)	1.95
Fan+top heater+grill(kW)	1.95
Temperature	50-250°C
Frequency(Hz)	50/60
Electrical Input(V)	220-240V/ 380-415V 3N~
Oven power(kW)	2.0
Hotplate power(kW)	7.2
Total main power(kW)	9.2

ELECTRICAL CONNECTION

Caution !

All electrical work should be carried out by a suitably qualified and authorized electrician. No alterations or willful changes in the electricity supply should be carried out.

The fixing line connected must be equipped with the all-pole disconnection device provided by breakaway the contact under overvoltage category III according to the wiring rules.

Fitting guidelines

The cooker is manufactured to work with three phase alternating current (380-415V 3N~50 Hz). The voltage rating of the cooker heating elements is 220-240V. Adapting the cooker to operate with one phase current is possible by appropriate bridging in the connection box according to the connection diagram below. The connection diagram is also found on the cover of the connection box. Remember that the connection wire should match the connection type and the power rating of the cooker.

CONNECTION DIAGRAM			Recommended type of connection lead
Caution! Voltage of heating elements 220-240V Caution! In the event of any connection the safety Wire must be connected to the \oplus E terminal.			
1	For 220-240V earthed one-phase connection, bridges connect 1-2-3 terminals and 4-5 terminals, safety wire to \oplus .		H05VV-F3G4
2	For 380-415V earthed three-phase connection, bridges connect 4-5 terminals, phases in succession 1,2 and 3, earth to 4-5, the safety wire to \oplus .		H05VV-F5G1,5
L1=R, L2=s, L3=T, N=Null Terminal, E=safety wire terminal			

The connection cable must be secured in a strain-relief clamp. For the connection leads, the grounding wire must be longer than the other wires.

Caution !

Remember to connect the safety circuit to the connection box terminal marked with \oplus . Before connecting the cooker to the power supply it is important read the information on the data plate and the connection diagram.