

Parts



x2 Side
SD015



b Bottom
CS018



x2 End
HZ015

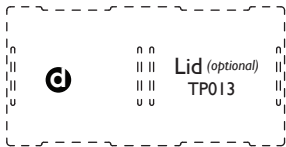

d Lid (optional)
TP013



x2 Divider
(optional)
DV001

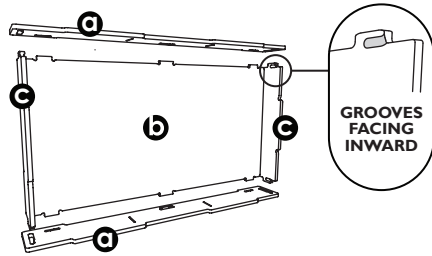

- 1 Lay side **a** on the ground with the slots facing up. Insert bottom **b** and ends **c**, placing other **a** on top.

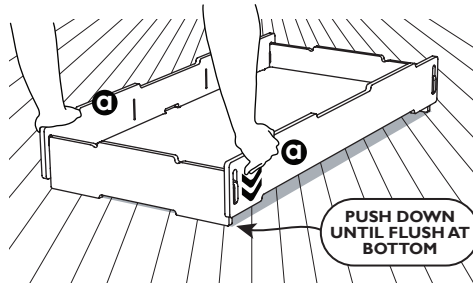

- 3 Place tray on hard floor, then press down each corner in turn to tighten.

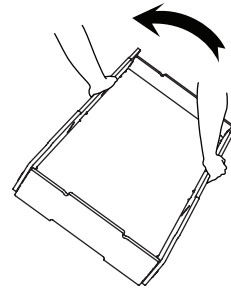

- 2 Hold sides firmly and rotate upright.

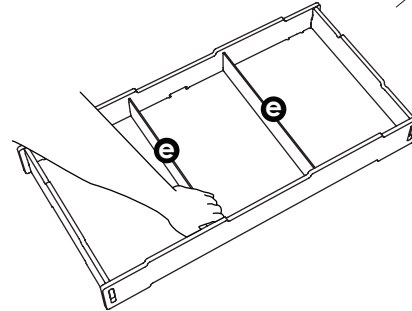

- 4 Pop *optional* dividers **e** into place, as shown.

sprout

Simple. Modern. American Made.



Need Help?

Watch our Assembly Video at
sprout-kids.com/cra

Or talk to our customer service agent at :
(877) 765-7860

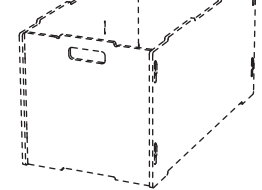
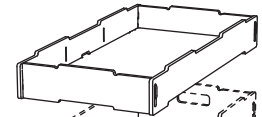
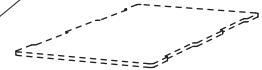

- ⚠ Adult assembly only
- ⚠ Assemble completely before use

Weight capacity 50 lbs