

## PARTS

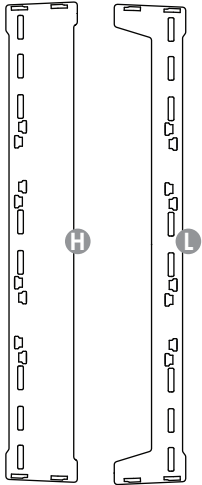

**A**

(2) Sides\*

\*2 **L**s OR 1 **H** & 1 **L**, depending on your order

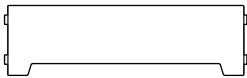

**B** (2) Ends

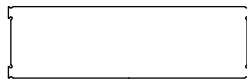

**C** (2) Wide Slats

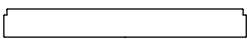

**D** (2) End Slats

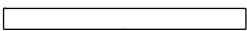

**E** (6) Pine Slats

## BEFORE YOU START

- ⚠ Wide Slats **C** need to be secured in place by sticking the tabs on **C** into the corresponding slots on Sides **A** that are larger on the top than the bottom. Push down to tighten.

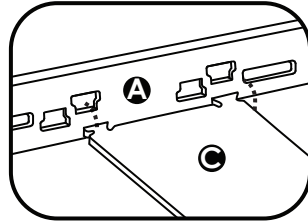

- ⚠ For children under 18 months, do not place side of bed closer than 12 inches to a wall.

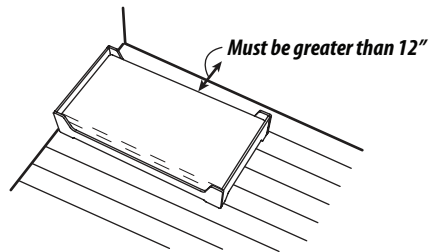

- \* Tab will 'pop' into slot when force is applied.

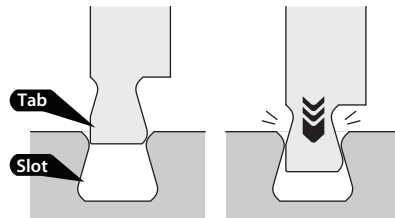

## ASSEMBLY INSTRUCTIONS

- 1 Push tabs of one End **B** into slots on Sides **A**. Push down on **A** to tighten.

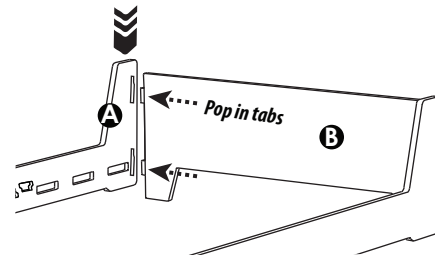

- 2 Place all Slats **C**, **D**, & **E** into their respective slots, as shown.

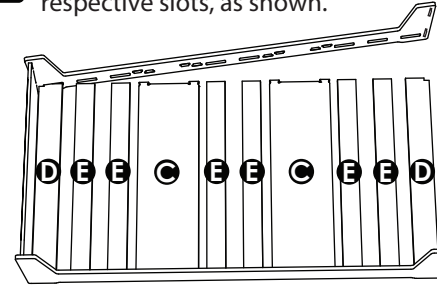

- 3 With help from another person, bring other Side together, placing each Slat into its slot in turn.

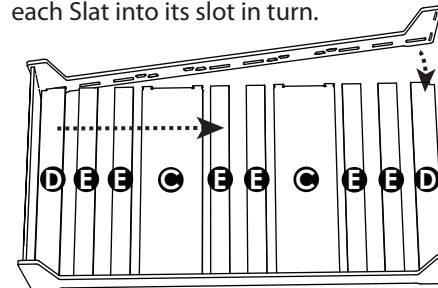

- 4 Insert the opposite End **B** into position, and tighten, just like Step 1.

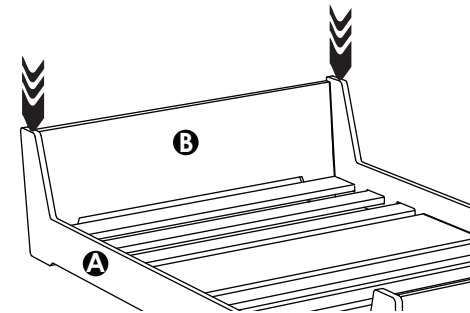

**sprout**

Simple. Modern. American Made.

## TWIN FLOOR BED

- ⚠ Adult assembly only
- ⚠ Assemble completely before use
- ⚠ 2 people recommended for assembly.

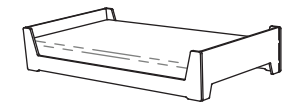

Low Position

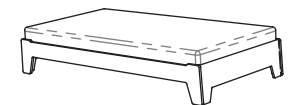

High Position

**STOP** Frustrated?  
Need Help?

Talk to our customer service agent at:

+1 (833) 530-0033

Or email us at:

[support@sprout-kids.com](mailto:support@sprout-kids.com)

Watch our assembly video  
[sprout-kids.com/fba](https://www.sprout-kids.com/fba)

## REMEMBER

- ⚠ For children under 18 months, do not place side of bed closer than 12 inches to a wall.

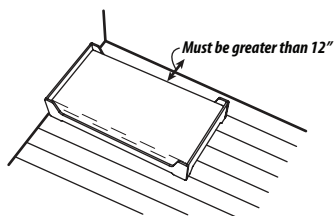

## CHANGING FROM LOW TO HIGH POSITION

- 5 To change floor bed from low to high position, bed must be fully disassembled. To loosen joints, place a flat hard object, such as a book, under Side **A** and push down on End **B**.

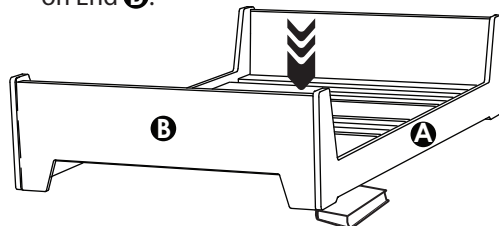

- ⚠ When reassembling keep Ends **B** and Sides **A** oriented with feet down, as shown.

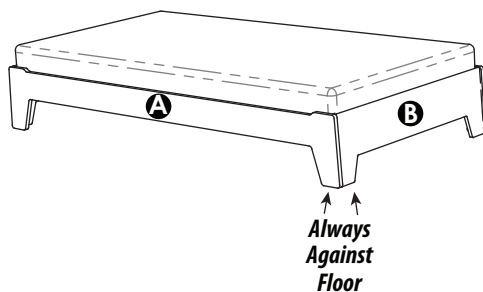

- ⚠ Wide Slats **C** need to be secured in place by sticking the tabs on **C** into the corresponding slots on Sides **A** that are larger on the top than the bottom. Push down to tighten.

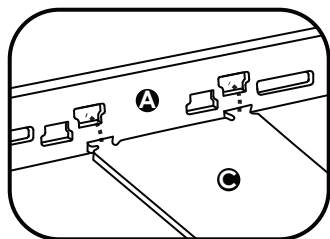

- 6 Complete Steps 1 - 4 to reassemble bed in High Position.

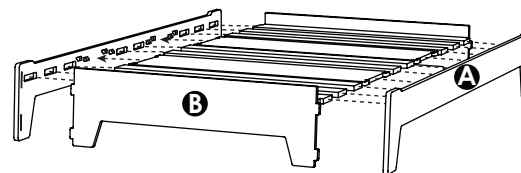

**sprout**

Simple. Modern. American Made.

## TWIN FLOOR BED

- ⚠ Adult assembly only
- ⚠ Assemble completely before use
- ⚠ 2 people recommended for assembly.



Low Position

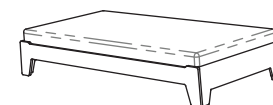

High Position

**STOP** Frustrated?  
Need Help?

Talk to our customer service agent at:

**+1 (833) 530-0033**

Or email us at:

**support@sprout-kids.com**

Watch our assembly video  
**sprout-kids.com/fba**