

## PARTS

## BEFORE YOU START

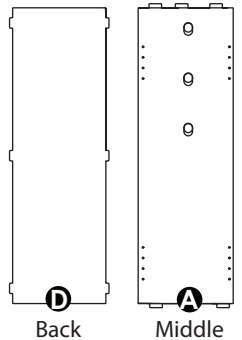

Back

Middle

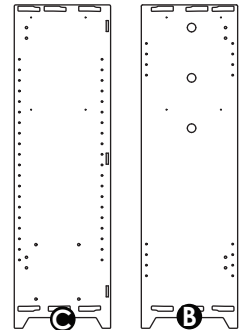

Left Side

Right Side

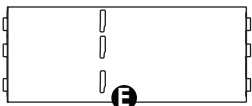

Top Shelf

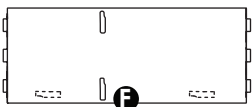

Bottom Shelf



Toe

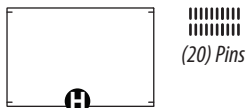

Wide Shelf

(20) Pins

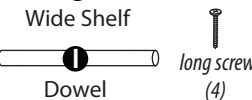

Dowel

long screws  
(4)

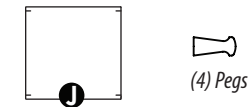

(4) Pegs

\* Orient tabs so the side with the wider lip faces the same direction as the notch in the slot.

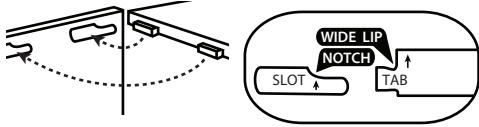

\* Place tab into open slot then lock tabs into the notch as pictured above.



! When fully tightened, the edges should be flush. A rubber mallet can help push pieces together. A hammer can also be used with a scrap piece of wood or a cutting board placed over the surface being hammered to protect it.

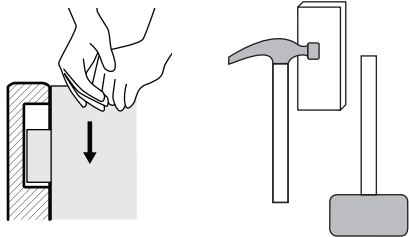

! 2 people recommended for assembly. Assemble on a hard floor.

## ASSEMBLY INSTRUCTIONS

1 Push tabs on Toe **G** into slots on Bottom **F**. Tabs and slots must be lined up correctly or they will not tighten properly. See \*.

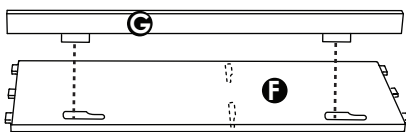

2 Turning the part upright push down on Toe **G** until the ends are flush with edge of Bottom Shelf **F**.

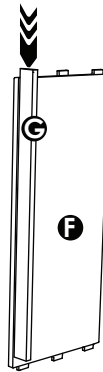

3 Refer to \*. Pop Middle **A** into corresponding slots on Top Shelf **E** and Bottom Shelf **F** then tighten according to \*.

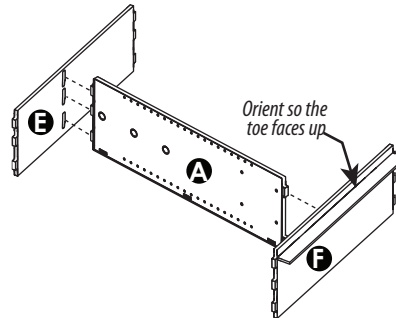

4 Pop Right Side **B** over tabs of Top Shelf **E** and Bottom Shelf **F**. Then tighten according to \*.

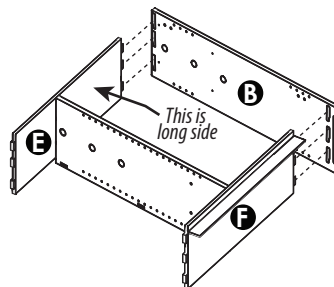

5 Turn unit onto Side **B** as shown. Insert Back **D** then Left Side **C**. Then tighten according to \*.

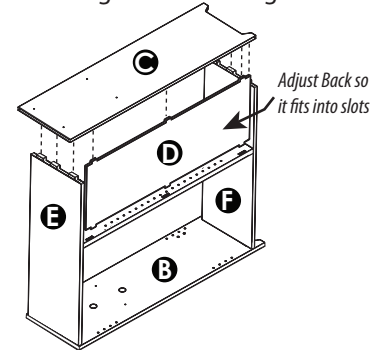

6 Refer to \*. To fully tighten unit, push down on Top Shelf **E** until ends are flush with sides.

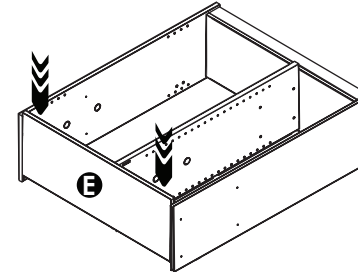

7 Put (4) Pins per shelf into desired holes. Slide Short Shelves **J** onto pins and push down into place.

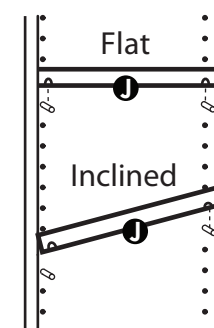

8 Install Dowel **I** at desired height, inserting as shown.

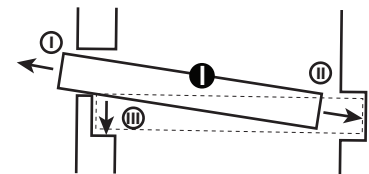

Simple. Modern. American Made.

## WARDROBE

! Adult assembly only

! Assemble completely before use

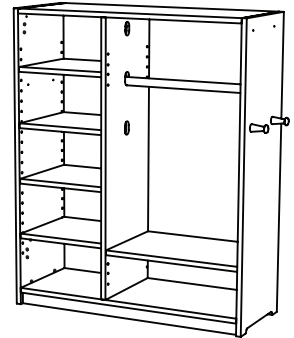

**STOP** Frustrated? Need Help?

Talk to our customer service agent at:  
**+1 (833) 530-0033**  
Or watch our assembly video at:  
[sprout-kids.com/wra](http://sprout-kids.com/wra)

9 Install Pegs by inserting Long Screw from inside of wardrobe, then threading on Peg.

