

## PARTS

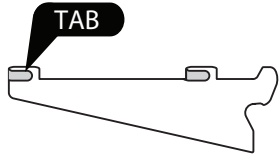

**A**  
(2) Brackets  
Various lengths available

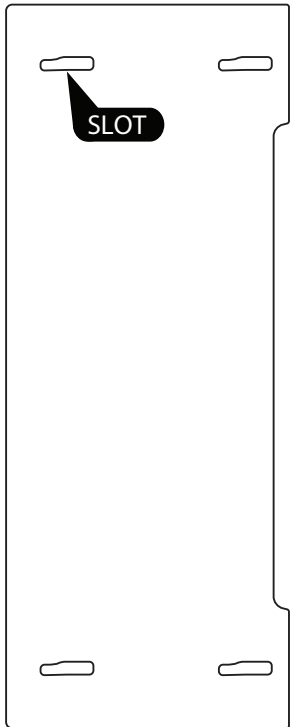

**B**  
Shelf  
Various lengths & depths available

## ASSEMBLY INSTRUCTIONS

- 1** Insert Brackets **A** into slotboard at desired height. Ensure distance between brackets matches slots on shelf.

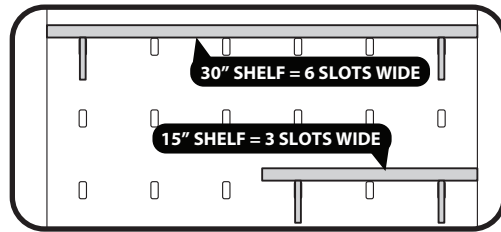
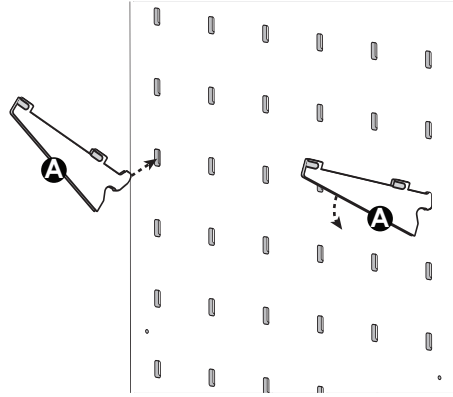

- 2** Gently set Shelf **B** on top of brackets with the indented side facing back towards the slotboard, and the shelf slots facing down.

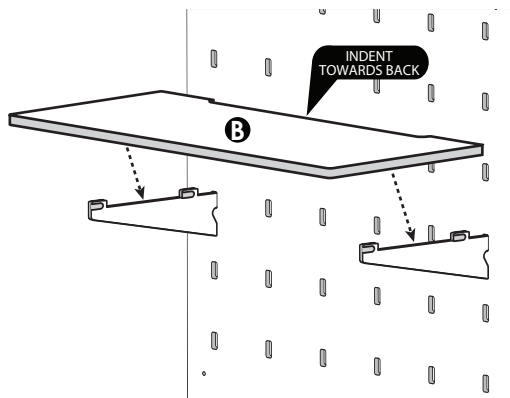

- 3** Place tabs into open slot.



- 4** Push shelf tight against slotboard above both brackets to tighten the joints.

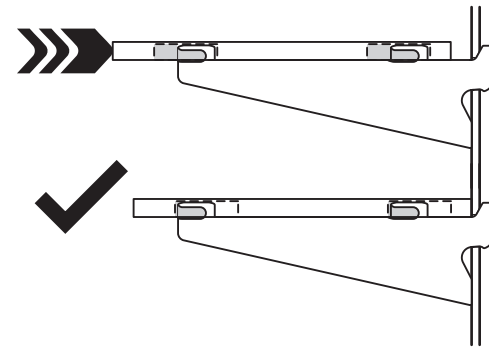
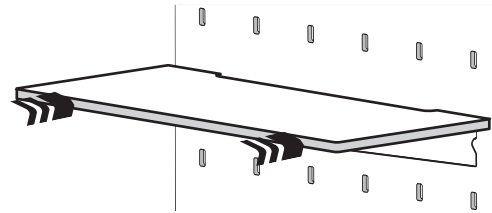

- \*** For disassembly, loosen tabs and remove shelf from brackets before removing brackets from slotboard.

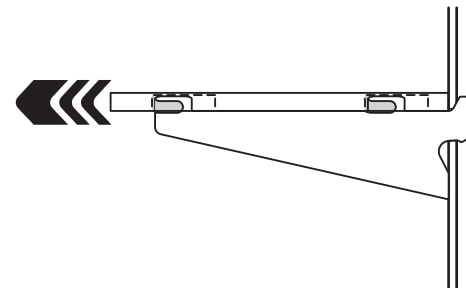

**sprout**  
Simple. Modern. American Made.

## MakerWall Shelf

- ⚠ Adult assembly only
- ⚠ Assemble completely before use

**STOP** Frustrated?  
Need Help?

Talk to our customer service agent at:  
**+1 (833) 530-0033**