

## PARTS

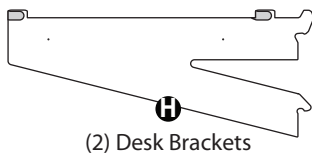
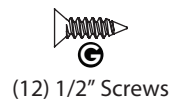
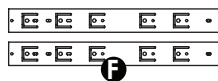
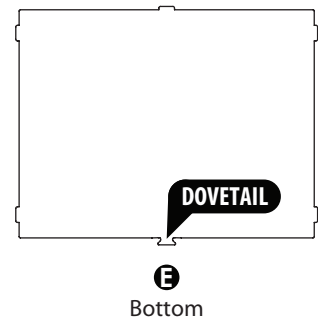
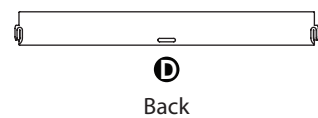
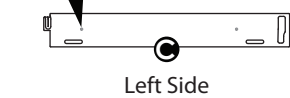
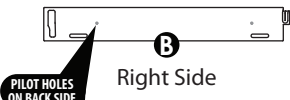
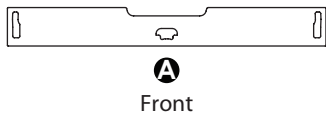

## ASSEMBLY INSTRUCTIONS

read through entirely before starting

- 1** Remove small end of both Drawer Rails **F** by bending switch and pulling, as shown.

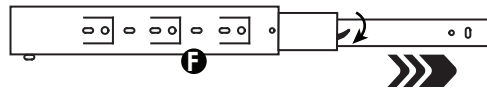

- 2** Install small ends of Drawer Rail **F** onto Sides **B** & **C** by threading Screws **G** into pilot holes. Check rail & side orientation below before installing.

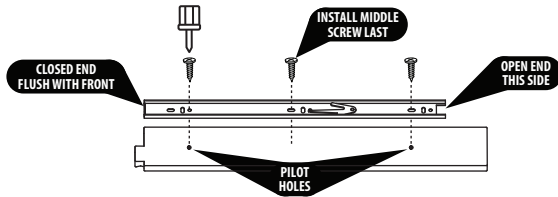

- 3** Install large ends of Drawer Rail **F** onto the Left & Right sides of (2) Desk Brackets **H** by threading (2) Screws **G** into pilot holes. Check rail & side orientation below before installing.

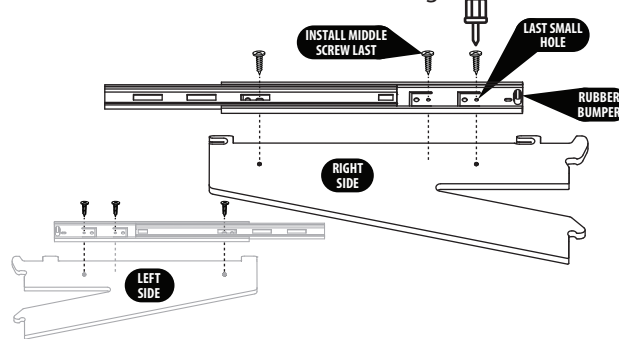

- 4** Orient Back **D** and Sides **B** & **C** in position shown, then insert tab into slot.

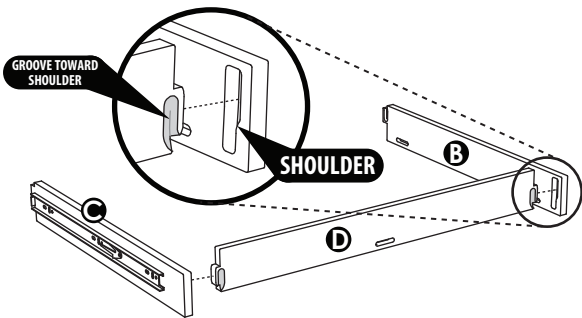

- 5** Tighten joints by pressing down on back **D**, as shown.

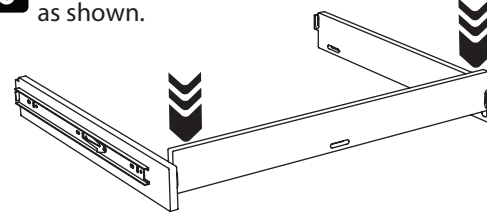

- 6** Gently bend sides apart, and insert Bottom **E** into position.

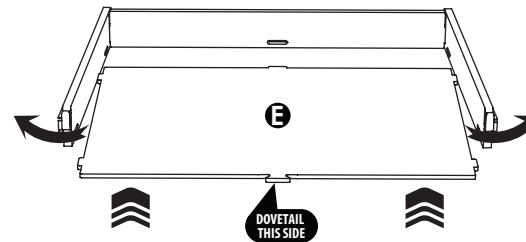

- 7** Put slots on Front **A** onto tab on Left Side **B** & dovetail on Bottom **E**.

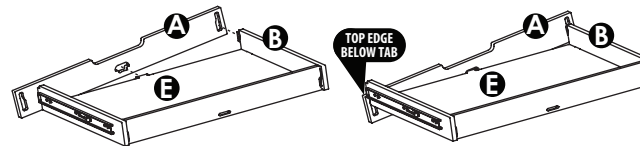

- 8** Carefully maneuver slot on Front **A** around and over tab on Left Side **C**. Bottom **E** will bend as you do this.

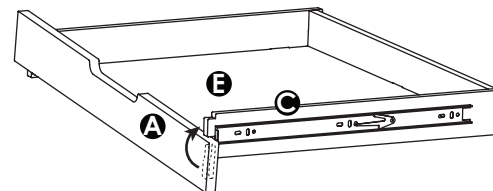

- 9** Tighten Front **A** by pushing down Sides **B** & **C** until firm.

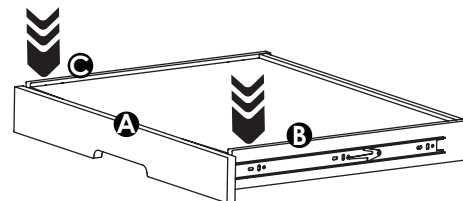

Simple. Modern. American Made.

## MakerWall Desk Drawer

⚠ Adult assembly only

⚠ Assemble completely before use

**STOP** Frustrated? Need Help?

Talk to our customer service agent at:  
**+1 (833) 530-0033**

- 10** Assemble Desktop per MakerWall Desk Assembly Instructions

- 11** Carefully insert assembled drawer into position, making sure the small end of Drawer Rails **F** snap back into the larger halves.

