



# LUCE SHELVES

-  Adult assembly only
-  Assemble completely before use
-  Do not allow children to climb up shelves at any time.

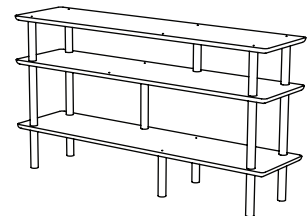
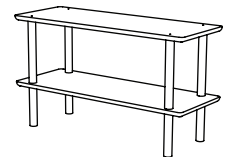
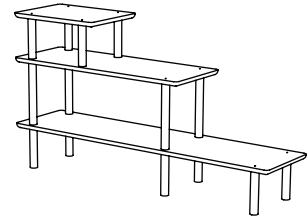

 **Frustrated?  
Need Help?**

Talk to our customer service agent at:  
**+1 (833) 530-0033**

## PARTS

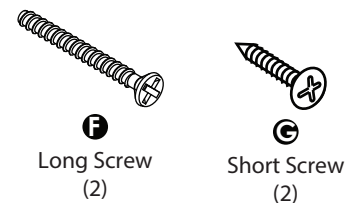
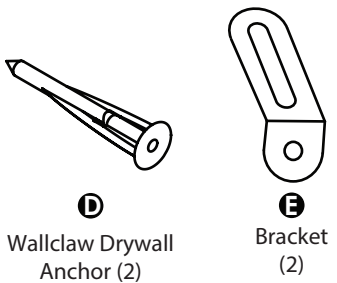
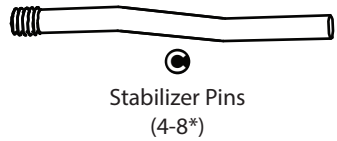
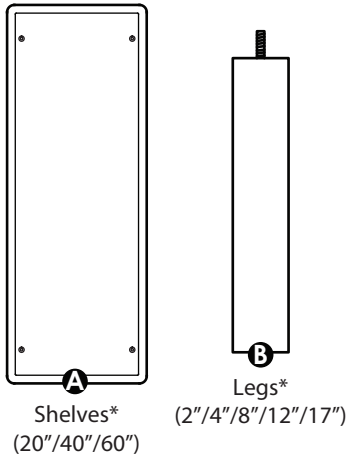

 The number of Shelves **A**, Legs **B**, and Stabilizer Pins **C** vary depending on ordered unit. You may have extra parts according to your design choice.

## BEFORE YOU START

 Be sure that you are always screwing the legs up into the bottom of the shelf.

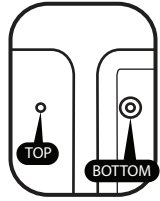

## ASSEMBLY INSTRUCTIONS

**1** Legs **B** are screwed tightly into the underside of the Shelves **A**.

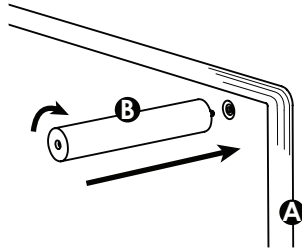

**2** Stabilizer Pins **C** are screwed into at least two corners of tops of lower Shelves **A**.

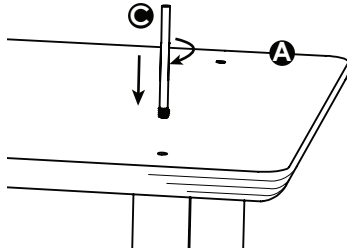

**3** Shelves **A** are securely stacked by placing Legs **B** over Stabilizer Pins **C** and pressing down until flush.

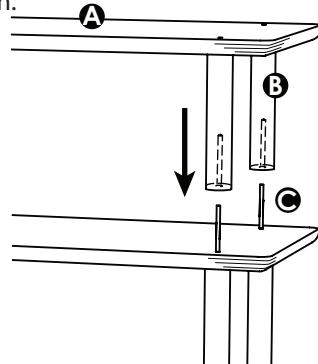

**4** Stack Shelves **A** according to your desired configuration to create your shelving unit.

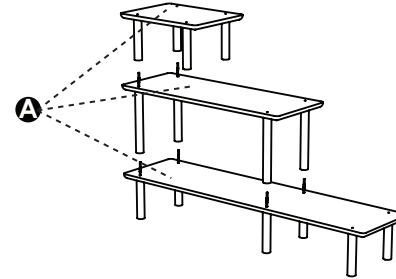

**5** To anchor to the wall, thread the Short Screw **G** through the long slot on the Bracket **E** into the two pilot holes underneath the top Shelf **A**.

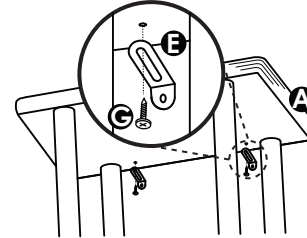

**6** Push the Bracket **E** flush against the wall and mark the wall through the hole. Do this with both brackets.

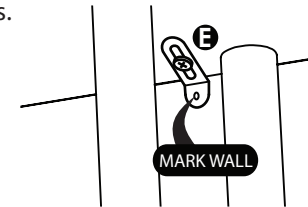

**7** Move the unit out of the way then use a hammer to pound the Wallclaw Drywall Anchor **D** into the wall at the two marked points.

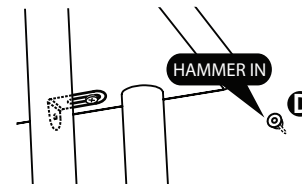

**8** Move the shelf back against the wall and position the Brackets **E** against the Wallclaw Drywall Anchors **D**, then screw in Long Screw **F** until tight.

