

## Parts

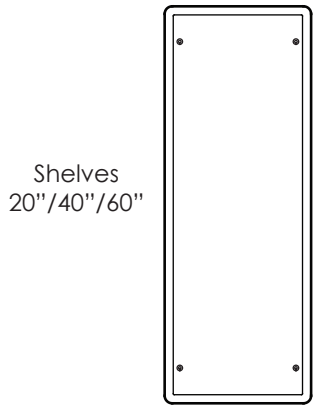

Shelves  
20"/40"/60"



Legs  
2"/4"/8"/12"/17"

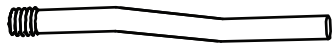

Stabilizer Pins

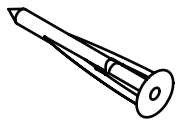

Wallclaw  
Drywall Anchor  
(2x)

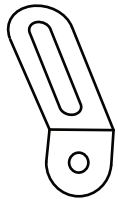

Bracket  
(2x)

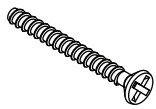

Wallclaw Screw  
(2x)



Short screws  
(2x)

**!** Be sure that you are always screwing the legs up into the bottom of the shelf.

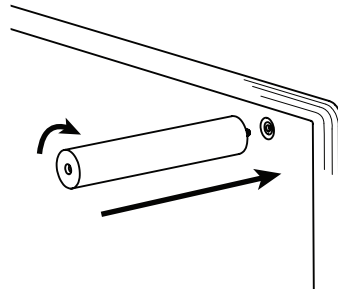
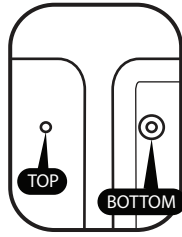

**1** Legs are screwed tightly into the underside of the shelves

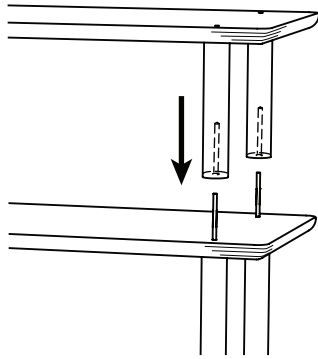

**3** Shelves are securely stacked by placing legs over Stabilizer Pins, and pressing down until flush.

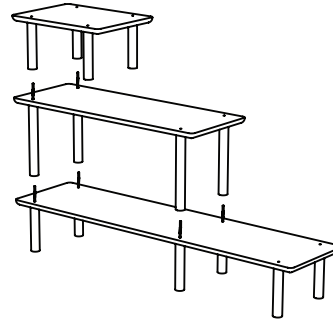

**4** Stack shelves according to your desired configuration to create your shelving unit.

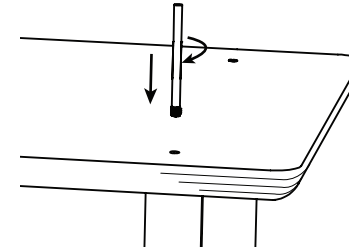

**2** Stabilizer Pins are screwed into the tops of lower shelves.

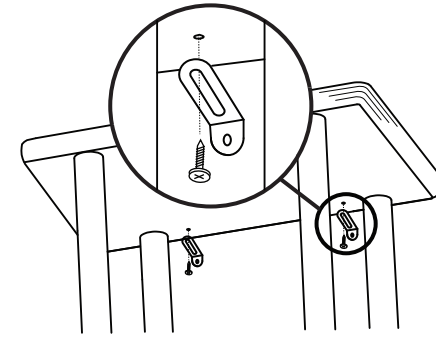

**5** To anchor to the wall, thread the short screw through the long slot on the bracket into the two pilot holes underneath the top shelf.

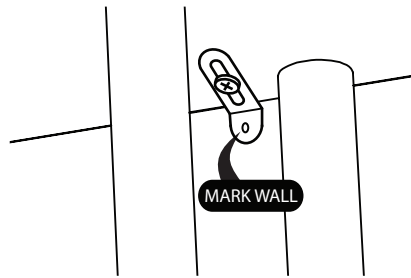

**6** Next, push the bracket flush against the wall, and mark the wall through the hole. Do this with both brackets.

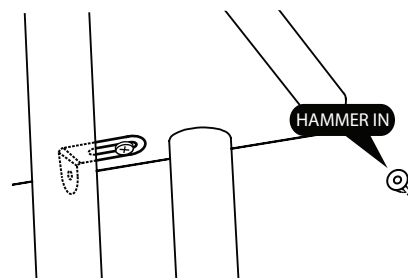

**7** Move the brackets and shelf out of the way, then use a hammer to pound Wallclaw Drywall Anchor into the wall at the two marked points.

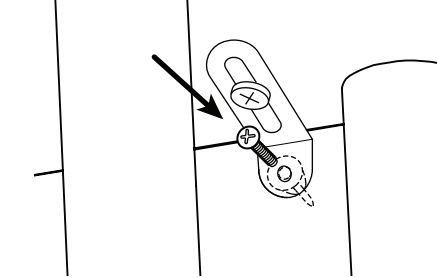

**8** Move the shelf back against the wall, position the brackets against the Wallclaw Drywall Anchors, then screw in Long Screw until tight.



Simple. Modern. American Made.

## Need Help?

Go to [sprout-kids.com/kha](http://sprout-kids.com/kha)

Or talk to our customer service agent at:  
**+1 (385) 208-1463**

**!** Assemble completely before use

**!** Do not allow children to climb up shelves at any time.

## Luce Shelves

