

## Need Help?

For Assembly Help  
or Replacement Parts,  
call our Support Team:  
+1 (833) 530-0033

## Six Cube Shelf

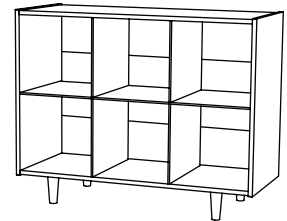

### Parts

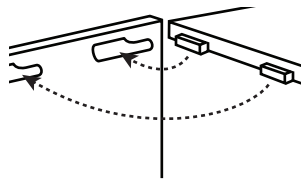
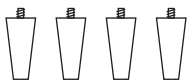
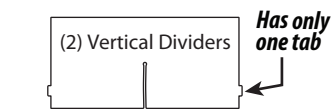
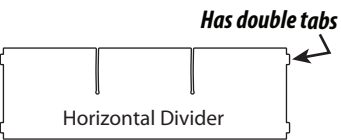
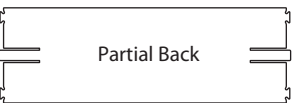
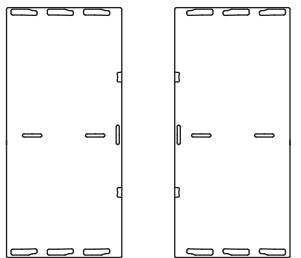

**\*** Each time you insert tabs into slots, make sure the side with the larger lip on the tab faces the same direction as the notch in the slot.

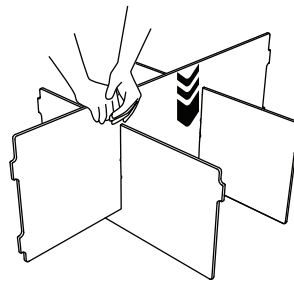
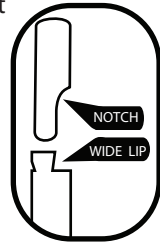

**1** Slide Horizontal Divider into slots on Vertical Dividers, as shown. Set aside.

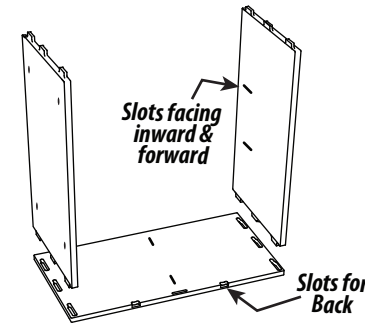

**2** Refer to **\***. Pop the tabs on Top Shelf and Bottom Shelf into slots on Left Side. Ensure slots on shelves are facing inward and forward. Have a second adult help hold parts in place through step 6.

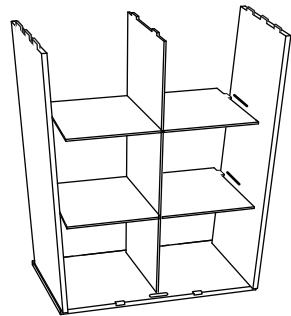

**3** Place divider assembly in between the shelves, as shown.

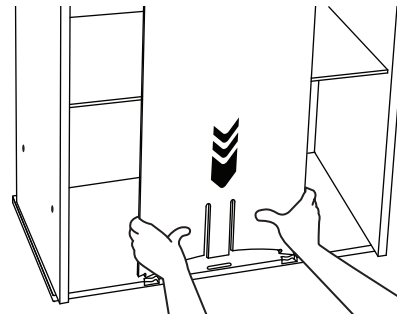

**4** Insert center tab of Partial Back into center slot on Side. Holding the piece as shown, flex the back and push the dovetail tabs into the open slots.

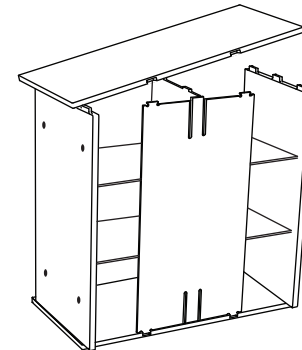

**5** As one adult holds the back and shelves steady, insert bottom slots on Right Side into the tabs on Bottom Shelf.

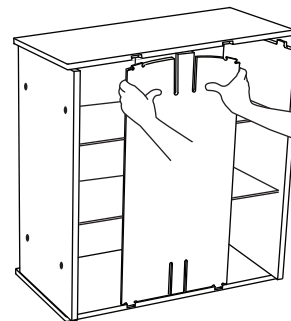

**6** Insert center tab on Back into slot on side. Flexing the Back, push tabs into open slots. Then insert tabs on Top into slots on side.

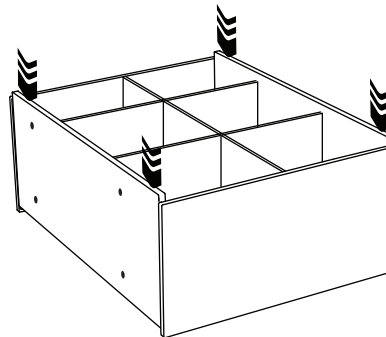

**7** Carefully tip shelving unit onto its back on a hard floor and press down on ends of Bottom and Top Shelves until flush with sides.

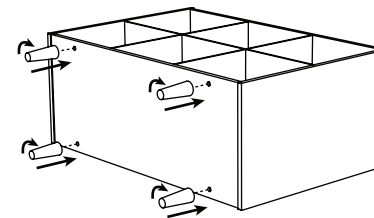

**8** Lastly, screw in the four legs into the Bottom Shelf until tight, as shown.

- ⚠** 2 Adults recommended for assembly
- ⚠** Assemble completely before use