

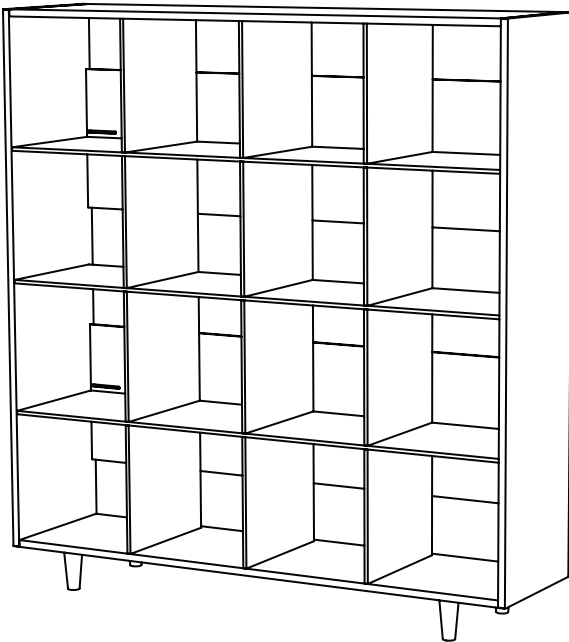

Simple. Modern. American Made.

Sixteen Cube Shelf



Adult assembly only
2 Adults recommended for assembly
Assemble completely before use

Parts

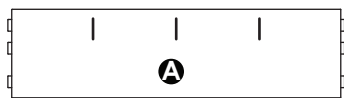

Top Shelf

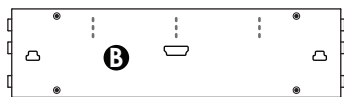

Bottom Shelf

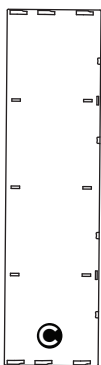

Left Side

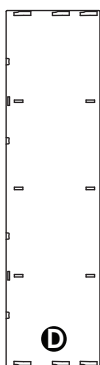

Right Side



(2) Partial Backs

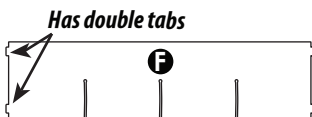

(3) Horizontal Dividers

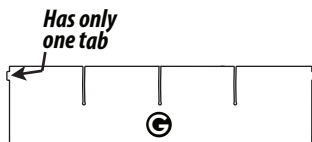

(3) Vertical Dividers



(4) Feet

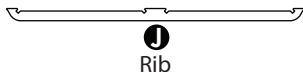

Rib



RECOMMENDED: A rubber mallet can help push pieces together. A hammer can also be used with a scrap piece of wood or a cutting board placed over the surface being hammered for protection.

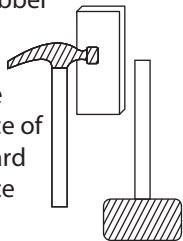

When inserting tabs into slots make sure the side with the wider lip on the tab faces the same direction as the notch in the slot.

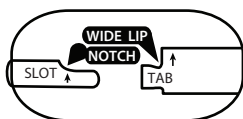
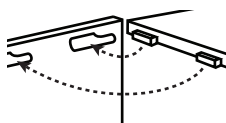

Tab will 'pop' into slot when force is applied.

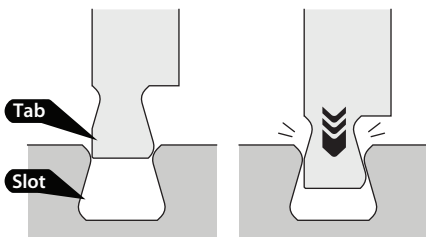

**Frustrated?
Need Help?**

Talk to our customer service agent at:
+1 (833) 530-0033

Or email us at:
support@sprout-kids.com

ASSEMBLY INSTRUCTIONS

- 1 Slide **Horizontal Dividers** **F** into slots on **Vertical Dividers** **C**, as shown. Set aside.

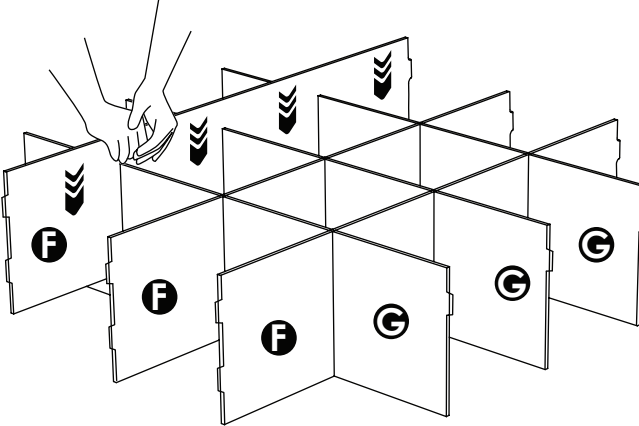

- 2 Pop the tabs on **Top Shelf** **A** and **Bottom Shelf** **B** into slots on **First Side** **C**. Ensure slots on shelves are facing **inward** and **forward**.

Have a second adult help hold parts in place through step 6.

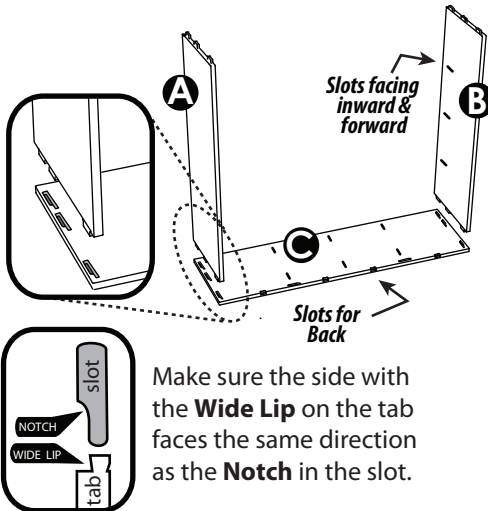

- 3** Place divider assembly in between the shelves, as shown.

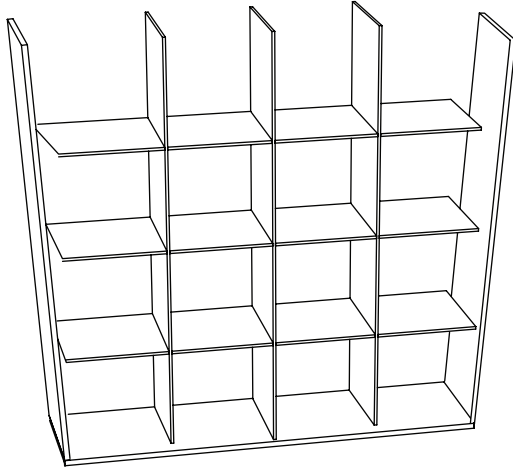

- 4** Insert center tab of **Back E** into center slot on Side. Holding the piece as shown, flex the back and push the dovetail tabs into the open slots.

Repeat for second partial back.

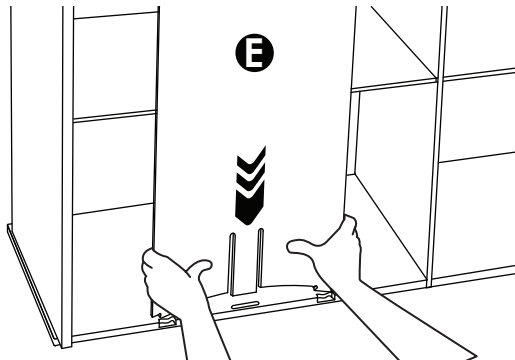

- 5** As one adult holds the back and shelves steady, insert bottom slots on **Second Side D** into the tabs on **Top Shelf A**.

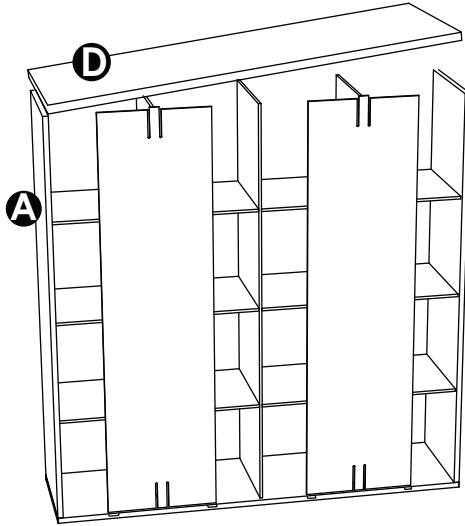

- 6** Insert center tab on Back **E** into slot on side. Flexing the Back, push tabs into open slots. Then carefully insert tabs from all intersecting parts into slots on **Side D**.

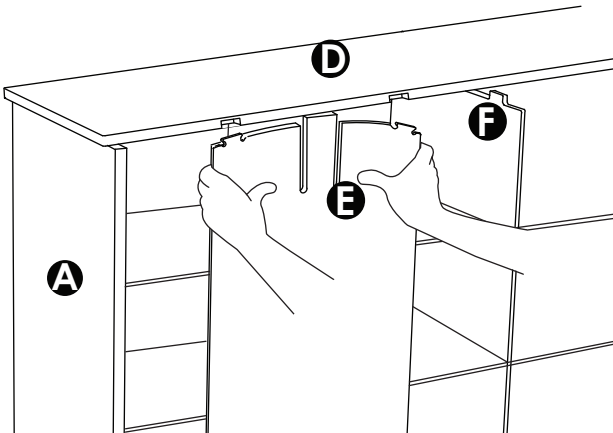

- 7** Carefully tip shelving unit onto its back on a hard floor and press down on ends of **Bottom B** and **Top A** until flush with sides.

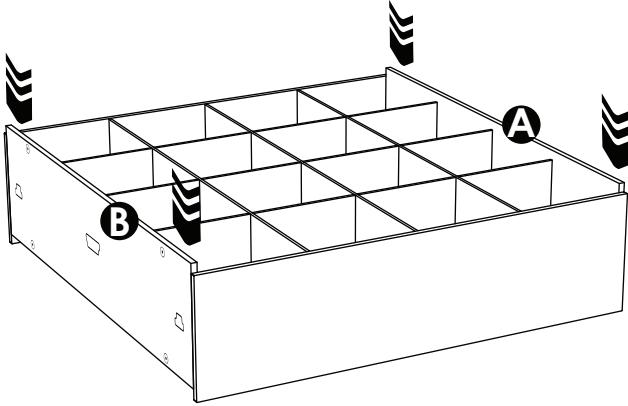

- 8** Screw in the four **Legs H** into the **Bottom B** until tight, as shown.

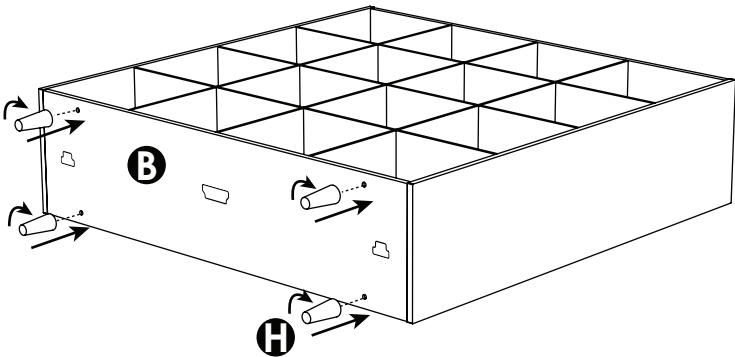

- 9** Put left tab on Rib **J** into left slot on Bottom Shelf **B**.

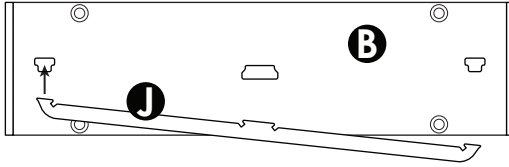

- 10** With the left tab mostly in its slot, bring Rib **J** up and pop the middle tab partially into its slot.

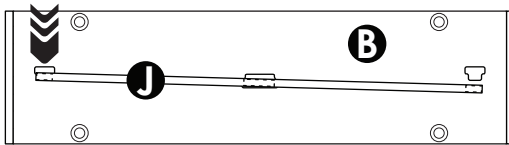

- 11** With the middle tab partially in its slot, bend the right tab of Rib **J** back up to its slot and pop it in.

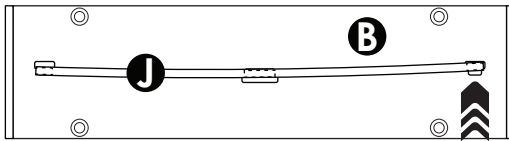

- 12** With all three tabs in their slots, straighten Rib **J**.

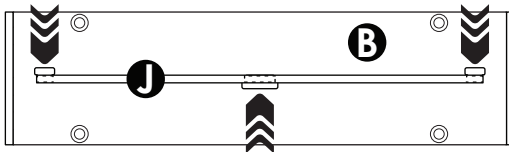



Simple. Modern. American Made.