

Temperature and Humidity Sensor for Low Temperature Environment R718A Data Sheet

Wireless Sensor Network Based on LoRa Technology



R718A

Copyright©Netvox Technology Co., Ltd.

This document contains proprietary technical information which is the property of NETVOX Technology. It shall be maintained in strict confidence and shall not be disclosed to other parties, in whole or in part, without written permission of NETVOX Technology.

The specifications are subject to change without prior notice.

Temperature and Humidity Sensor for Low Temperature Environment

General Description

NETVOX Wireless Sensor R718A is capable to measure temperature and humidity at low temperature environment.

R718A can be used in domestic and commercial refrigerators to store and transport food, medicines, flowers and other perishable goods, on the walls or in logistics refrigerators. Suitable as a data logger.

Principle of Operation

NETVOX Wireless Temperature Sensor outputs the ambient temperature in degrees Celsius. It is programmed to sleep for a user-given time interval (heartbeat) and then wakeup. To stay within the abilities of the processor, the temperature is computed off a data table provided by the manufacturer.

Example Applications

- Ambient Temperature Monitoring
- Environmental Monitoring
- Smart City & Smart Building
- HVAC Operation & Testing
- Data Center Monitoring
- Store and Transport Food, Medicines
- Flowers and Other Perishable Goods
- On the Walls or in Logistics Refrigerators
- And many more...

Features of NETVOX Sensors

- LoRaWAN™ Class A compatible
- Frequency Hopping Spread Spectrum (FHSS)
- Improved interference immunity
- Improved power management for longer battery life
- Encrypt-RF™ Security (Diffie-Hellman Key Exchange + AES-128 CBC for sensor data messages)
- Battery Life*2:
 - Please refer to web: http://www.netvox.com.tw/electric/electric_calc.html
 - At this website, users can find battery life time for varier models at different configurations.
 - Over-the-air updates (future)
- Third-Party online wireless sensor monitoring and notification system to configure sensors, view data and set alerts via SMS text and email (optional)
- Available third-party platform: Actility/ThingPark, TTN, MyDevices/Cayenne
- R718X series carry magnets which can be attached to ferromagnetic materials and objects

*1. Actual range may vary depending on environment.

*2. Battery life is determined by sensor reporting frequency and other variables

Temperature and Humidity Sensor for Low Temperature Environment

Technical Specifications

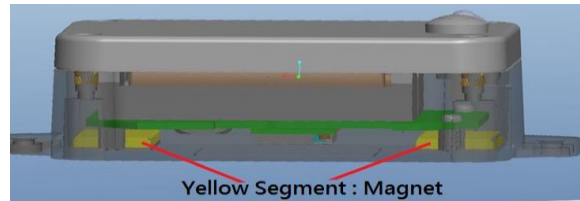
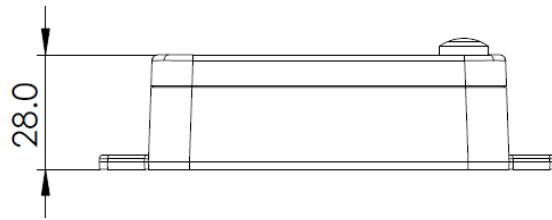
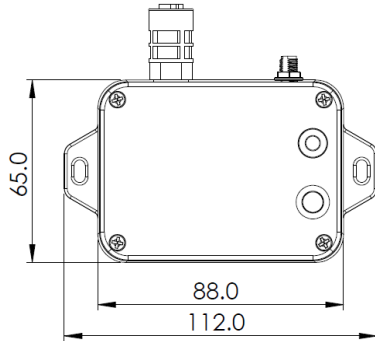

Electric

Input Power	2 x 3.6V ER14505 AA lithium batteries (3.6V2400mah/section)
Battery Life	5 years (Conditions: ambient temperature 25 °C, 15 min heartbeats, txpower = 20dBm, LoRa spreading factor SF = 10)
Sleeping Mode	20uA
Wake up Mode	6.3mA@3.3V
Low Voltage Threshold	3.2V
Transmitting current (max)	120mA@3.3V
Receiving current (max)	11mA @3.3V

Thermistor SHT-35

Model	SHT-35 (Brand : Sensirion)
Power Supply	+3.3VDC
Temperature Detecting Range	-40°C ~ 55°C
Temperature Accuracy	±0.3°C @25°C
Humidity Detecting Range	0%RH~ 100%RH
Humidity Accuracy	±2%RH @25°C

Temperature and Humidity Sensor for Low Temperature Environment

Frequency

TX Power	19dBm±1dBm
Rx Sensitivity	-136dBm (LoRa, Spreading Factor=12, Bit Rate=293bps) -121dBm (FSK,Frequency deviation=5kHz, Bit Rate=1.2kbps)
Antenna Type	Build-in antenna
Communication Range	Up to 10km, the actual transmission distance depends on the environment.
Data Transfer Rate	0.3kbps ~ 50kbps
Spread Technique	LoRa/FSK
Available Frequency	EU863-870, US902-928, AU915-928, KR920-923, AS923, CN470-510 Configured before shipment

Physical

Dimension	Main Body: L: 112mm*W: 65mm*H: 32mm Sensor cover size: D: 16mm*L: 34.5mm,
Weight	141g
Environment Temperature Range	-40°C ~ 55°C
Environment Humidity Range	<90% RH (No condensation)
Storage Temperature	-40°C ~ 85°C

Contact:

NETVOX TECHNOLOGY CO., LTD.

TEL: 886-6-2617641

FAX: 886-6-2656120

E-mail: sales@netvox.com.tw

WEB: www.netvox.com.tw

NETVOX TECHNOLOGY CO., LTD (XIAMEN)

TEL: 86-592-5717188

FAX: 86-592-5717180

E-mail: dyx@netvox.com.cn

WEB: www.netvox.com.cn