



ME910C1/NE910C1/ML865C1 AT Commands Reference Guide

80529ST10815A Rev. 9 – 2019-08-01

TELIT
TECHNICAL
DOCUMENTATION

SPECIFICATIONS ARE SUBJECT TO CHANGE WITHOUT NOTICE

NOTICE

While reasonable efforts have been made to assure the accuracy of this document, Telit assumes no liability resulting from any inaccuracies or omissions in this document, or from use of the information obtained herein. The information in this document has been carefully checked and is believed to be reliable. However, no responsibility is assumed for inaccuracies or omissions. Telit reserves the right to make changes to any products described herein and reserves the right to revise this document and to make changes from time to time in content hereof with no obligation to notify any person of revisions or changes. Telit does not assume any liability arising out of the application or use of any product, software, or circuit described herein; neither does it convey license under its patent rights or the rights of others.

It is possible that this publication may contain references to, or information about Telit products (machines and programs), programming, or services that are not announced in your country. Such references or information must not be construed to mean that Telit intends to announce such Telit products, programming, or services in your country.

COPYRIGHTS

This instruction manual and the Telit products described in this instruction manual may be, include or describe copyrighted Telit material, such as computer programs stored in semiconductor memories or other media. Laws in the Italy and other countries preserve for Telit and its licensors certain exclusive rights for copyrighted material, including the exclusive right to copy, reproduce in any form, distribute and make derivative works of the copyrighted material. Accordingly, any copyrighted material of Telit and its licensors contained herein or in the Telit products described in this instruction manual may not be copied, reproduced, distributed, merged or modified in any manner without the express written permission of Telit. Furthermore, the purchase of Telit products shall not be deemed to grant either directly or by implication, estoppel, or otherwise, any license under the copyrights, patents or patent applications of Telit, as arises by operation of law in the sale of a product.

COMPUTER SOFTWARE COPYRIGHTS

The Telit and 3rd Party supplied Software (SW) products described in this instruction manual may include copyrighted Telit and other 3rd Party supplied computer programs stored in semiconductor memories or other media. Laws in the Italy and other countries preserve for Telit and other 3rd Party supplied SW certain exclusive rights for copyrighted computer programs, including the exclusive right to copy or reproduce in any form the copyrighted computer program. Accordingly, any copyrighted Telit or other 3rd Party supplied SW computer programs contained in the Telit products described in this instruction manual may not be copied (reverse engineered) or reproduced in any manner without the express written permission of Telit or the 3rd Party SW supplier. Furthermore, the purchase of Telit products shall not be deemed to grant either directly or by implication, estoppel, or otherwise, any license under the copyrights, patents or patent applications of Telit or other 3rd Party supplied SW, except for the normal non-exclusive, royalty free license to use that arises by operation of law in the sale of a product.

USAGE AND DISCLOSURE RESTRICTIONS

I. License Agreements

The software described in this document is the property of Telit and its licensors. It is furnished by express license agreement only and may be used only in accordance with the terms of such an agreement.

II. Copyrighted Materials

Software and documentation are copyrighted materials. Making unauthorized copies is prohibited by law. No part of the software or documentation may be reproduced, transmitted, transcribed, stored in a retrieval system, or translated into any language or computer language, in any form or by any means, without prior written permission of Telit

III. High Risk Materials

Components, units, or third-party products used in the product described herein are NOT fault-tolerant and are NOT designed, manufactured, or intended for use as on-line control equipment in the following hazardous environments requiring fail-safe controls: the operation of Nuclear Facilities, Aircraft Navigation or Aircraft Communication Systems, Air Traffic Control, Life Support, or Weapons Systems ("High Risk Activities"). Telit and its supplier(s) specifically disclaim any expressed or implied warranty of fitness for such High Risk Activities.

IV. Trademarks

TELIT and the Stylized T Logo are registered in Trademark Office. All other product or service names are the property of their respective owners.















V. Third Party Rights

The software may include Third Party Right software. In this case you agree to comply with all terms and conditions imposed on you in respect of such separate software. In addition to Third Party Terms, the disclaimer of warranty and limitation of liability provisions in this License shall apply to the Third Party Right software.

TELIT HEREBY DISCLAIMS ANY AND ALL WARRANTIES EXPRESS OR IMPLIED FROM ANY THIRD PARTIES REGARDING ANY SEPARATE FILES, ANY THIRD PARTY MATERIALS INCLUDED IN THE SOFTWARE, ANY THIRD PARTY MATERIALS FROM WHICH THE SOFTWARE IS DERIVED (COLLECTIVELY "OTHER CODE"), AND THE USE OF ANY OR ALL THE OTHER CODE IN CONNECTION WITH THE SOFTWARE, INCLUDING (WITHOUT LIMITATION) ANY WARRANTIES OF SATISFACTORY QUALITY OR FITNESS FOR A PARTICULAR PURPOSE.

NO THIRD PARTY LICENSORS OF OTHER CODE SHALL HAVE ANY LIABILITY FOR ANY DIRECT, INDIRECT, INCIDENTAL, SPECIAL, EXEMPLARY, OR CONSEQUENTIAL DAMAGES (INCLUDING WITHOUT LIMITATION LOST PROFITS), HOWEVER CAUSED AND WHETHER MADE UNDER CONTRACT, TORT OR OTHER LEGAL THEORY, ARISING IN ANY WAY OUT OF THE USE OR DISTRIBUTION OF THE OTHER CODE OR THE EXERCISE OF ANY RIGHTS GRANTED UNDER EITHER OR BOTH THIS LICENSE AND THE LEGAL TERMS APPLICABLE TO ANY SEPARATE FILES, EVEN IF ADVISED OF THE POSSIBILITY OF SUCH DAMAGES.

APPLICABILITY TABLE

-   ME910C1-NA
-   ME910C1-NV
-   ME910C1-E1
-   ME910C1-AU
-   ME910C1-J1
-   ME910C1-K1
-   ME910C1-E2
-   ME910C1-WW
-   NE910C1-E1
-   NE910C1-NA
-   ML865C1-NA
-   ML865C1-EA
-   ME910C1-P1
-   ME910C1-P2



30.00.xx5 / M0B.xx0004

CONTENTS

NOTICE	2
COPYRIGHTS	2
COMPUTER SOFTWARE COPYRIGHTS	2
USAGE AND DISCLOSURE RESTRICTIONS	3
I. License Agreements	3
II. Copyrighted Materials	3
III. High Risk Materials	3
IV. Trademarks	3
V. Third Party Rights	3
APPLICABILITY TABLE	4
CONTENTS	5
1. INTRODUCTION	15
1.1. Scope	15
1.2. Audience	15
1.3. Contact Information, Support	15
1.4. Icons and Text Conventions	16
2. AT COMMANDS	17
2.1. Definitions	17
2.2. AT Command Syntax	17
2.2.1. String Type Parameters	18
2.2.2. Command Lines	18
2.2.2.1. ME Error Result Code - +CME ERROR: <err>	19
2.2.2.2. Message Service Failure Result Code - +CMS ERROR: <err>	22
2.2.3. Information Responses and Result Codes	22
2.2.4. Command Response Time-Out	23
2.2.5. Command Issuing Timing	23
2.3. Storage	23
2.3.1. Factory Profile and User Profiles	23
2.4. AT Command Short Overview Table	25
3. AT COMMANDS REFERENCES	26
3.1. General Control and Config	26
3.1.1. Command Line Prefixes	26
3.1.1.1. AT - Starting a Command Line	26
3.1.1.2. A/ - Last Command Automatic Repetition	27
3.1.1.3. AT#/ - Repeat Last Command	28
3.1.2. Generic Modem Control	29
3.1.2.1. AT#SELINT - Select Interface Style	29
3.1.2.2. AT&F - Set to Factory-Defined Configuration	30
3.1.2.3. ATZ - Soft Reset	31
3.1.2.4. AT&Y - Default Reset Basic Profile Designation	32

3.1.2.5.	AT&P - Default Reset Full Profile Designation	33
3.1.2.6.	AT&W - Store Current Configuration	34
3.1.2.7.	AT&N - Display Internal Phonebook Stored Numbers.....	35
3.1.2.8.	AT#Z - Extended Reset.....	36
3.1.2.9.	AT&V - Display some Configuration and Profile.....	37
3.1.2.10.	AT+GCI - Country of Installation	38
3.1.2.11.	AT+GCAP - Capabilities List	39
3.1.2.12.	AT+GMI - Manufacturer Identification	40
3.1.2.13.	AT+GMM - Model Identification.....	41
3.1.2.14.	AT+GMR - Revision Identification	42
3.1.2.15.	AT+GSN - Serial Number.....	43
3.1.2.16.	AT+CGMI - Request Manufacturer Identification.....	44
3.1.2.17.	AT+CGMM - Request Model Identification.....	45
3.1.2.18.	AT+CGMR - Request Revision Identification	46
3.1.2.19.	AT+CGSN - Request Product Serial Number Identification	47
3.1.2.20.	AT#CGMI - Request Manufacturer Identification.....	48
3.1.2.21.	AT#CGMR - Request Revision Identification	49
3.1.2.22.	AT#CGSN - Product Serial Number Identification.....	50
3.1.2.23.	AT#CGMF - Request Product Code.....	51
3.1.2.24.	AT#SWPKG - Request Software Package Version	52
3.1.2.25.	AT+CPAS - Phone Activity Status.....	53
3.1.2.26.	AT+CFUN - Set Phone Functionality.....	54
3.1.2.27.	AT+CIND - Indicator Control	56
3.1.2.28.	AT+CMER - Mobile Equipment Event Reporting	59
3.1.2.29.	AT+CSVM - Set Voice Mail Number	61
3.1.2.30.	AT#MBN - Mailbox Numbers.....	62
3.1.2.31.	AT#MWI - Message Waiting Indication	63
3.1.2.32.	AT+CLAC - Available AT Commands	65
3.1.2.33.	AT#LANG - Select Language.....	66
3.1.2.34.	AT+CMEE - Report Mobile Equipment Error.....	67
3.1.2.35.	AT+CEER - Extended Error Report.....	68
3.1.2.36.	AT#CEER - Extended Numeric Error Report	69
3.1.2.37.	AT#PSMRI - Power Saving Mode Ring Indicator	71
3.1.2.38.	AT+CSCS - Select TE Character Set.....	72
3.1.2.39.	AT+CMUX - Multiplexing Mode	73
3.1.2.40.	AT#USBCFG - USB Configuration.....	75
3.1.2.41.	AT#PORTCFG - Connect Physical Ports to Service Access Points.....	76
3.1.2.42.	AT#ATDELAY - AT Command Delay.....	78
3.1.2.43.	AT&Z - Store Telephone Number in the Internal Phonebook.....	79
3.1.2.44.	AT&V2 - Display Last Connection Statistics.....	80
3.1.2.45.	AT+IMEISV - Request IMEI and Software Version	81
3.1.2.46.	AT#CGMM - Request Model Identification	82
3.1.2.47.	AT&V0 - Display Current Configuration and Profile.....	83
3.1.2.48.	AT#FWSWITCH - Set Active Firmware Image.....	84
3.1.2.49.	AT#TID - Request Telit ID.....	86

3.1.3.	S Parameters	87
3.1.3.1.	ATS0 - Number of Rings to Auto Answer	87
3.1.3.2.	ATS1 - Ring Counter	88
3.1.3.3.	ATS2 - Escape Character	89
3.1.3.4.	ATS3 - Command Line Termination Character	90
3.1.3.5.	ATS4 - Response Formatting Character	91
3.1.3.6.	ATS5 - Command Line Editing Character	92
3.1.3.7.	ATS7 - Connection Completion Time-Out	93
3.1.3.8.	ATS12 - Escaper Prompt Delay	94
3.1.3.9.	ATS25 - Delay to DTR Off	95
3.1.3.10.	AT&V1 - S Registers Display	96
3.1.3.11.	ATS10 - Carrier Off with Firm Time	97
3.1.3.12.	AT&V3 - Extended S Registers Display	98
3.1.4.	DTE - Modem Interface Control	99
3.1.4.1.	ATE - Command Echo	99
3.1.4.2.	ATQ - Quiet Result Codes	100
3.1.4.3.	ATV - Response Format	101
3.1.4.4.	ATI - Identification Information	102
3.1.4.5.	AT&C - Data Carrier Detect (DCD) Control	103
3.1.4.6.	AT&D - Data Terminal Ready (DTR) Control	104
3.1.4.7.	AT&K - Flow Control	105
3.1.4.8.	AT&S - Data Set Ready (DSR) Control	106
3.1.4.9.	AT+IPR - UART DCE Interface Data Rate Speed	107
3.1.4.10.	AT+IFC - DTE-Modem Local Flow Control	109
3.1.4.11.	AT+ICF - DTE-Modem Character Framing	110
3.1.4.12.	AT#SKIPESC - Skip Escape Sequence	111
3.1.4.13.	AT#E2ESC - Escape Sequence Guard Time	112
3.1.4.14.	ATX - Extended Result Codes	113
3.1.5.	Call (Voice and Data) Control	114
3.1.5.1.	ATD - Dialup Connection	114
3.1.5.2.	ATH - Hang Up/Disconnect the Current Call	115
3.1.5.3.	ATO - Return to ON-Line Mode	116
3.1.6.	Modulation & Compression Control	117
3.1.6.1.	AT%E - Line Quality and Auto Retrain	117
3.2.	Network	118
3.2.1.	AT+CNUM - Subscriber Number	118
3.2.2.	AT+COPN - Read Operator Names	119
3.2.3.	AT+CREG - Network Registration Status	120
3.2.4.	AT+COPS - Operator Selection	122
3.2.5.	AT+CLCK - Facility Lock/Unlock	124
3.2.6.	AT+CPWD - Change Facility Password	126
3.2.7.	AT+CUSD - Unstructured Supplementary Service Data	127
3.2.8.	AT+CPOL - Preferred Operator List	129
3.2.9.	AT+CPLS - Selection of Preferred PLMN List	131
3.2.10.	AT+CSQ - Signal Quality	132

3.2.11.	AT#SERVINFO - Serving Cell Information	134
3.2.12.	AT#NWEN - Network Emergency Number Update	136
3.2.13.	AT#PLMNUPDATE - Update PLMN List	137
3.2.14.	AT#PLNMNMODE - PLMN List Selection	138
3.2.15.	AT#BND - Select Band	139
3.2.16.	AT#AUTOBND - Automatic Band Selection	141
3.2.17.	AT#SNUM - Subscriber Number	142
3.2.18.	AT#CEERNET - Extended Numeric Error Report for Network Reject Cause	143
3.2.19.	AT#CEERNETEXT - Extended Error Report for Network Reject Cause	146
3.2.20.	AT#CIPHIND - Cipherring Indication	148
3.2.21.	AT#PSNT - Packet Service Network Type	150
3.2.22.	AT#ENCALG - Set Encryption Algorithm	151
3.2.23.	AT+CEMODE - Set Mode of Operation for EPS	154
3.2.24.	AT+CESQ - Extended Signal Quality	155
3.2.25.	AT#ENS - Enhanced Network Selection	157
3.2.26.	AT+WS46 - PCCA STD-101 Select Wireless Network	158
3.2.27.	AT+CEDRXS - eDRX Setting	159
3.2.28.	AT#WS46 - Select IoT Technology	161
3.2.29.	AT+CEDRXRDP - eDRX Read Dynamic Parameters	162
3.2.30.	AT+CEREG - EPS Network Registration Status	163
3.2.31.	AT#RFSTS - Read Current Network Status	165
3.2.32.	AT#SPN - Read SIM Field SPN	169
3.2.33.	AT#CEDRXS - Extended eDRX Setting	170
3.2.34.	AT#MONI - Cell Monitor	173
3.3.	Time & Alarm	177
3.3.1.	AT+CCLK - Clock Management	177
3.3.2.	AT+CALA - Alarm Management	179
3.3.3.	AT+CAPD - Postpone Alarm	183
3.3.4.	AT+CSDF - Setting Date Format	184
3.3.5.	AT+CTZR - Time Zone Reporting	186
3.3.6.	AT+CTZU - Automatic Time Zone Update	187
3.3.7.	AT#NITZ - Network Identity and Time Zone	188
3.3.8.	AT#CCLK - Clock Management	190
3.3.9.	AT#CCLKMODE - Clock Mode	192
3.3.10.	AT#WAKE - Wake from Alarm Mode	194
3.3.11.	AT+CSTF - Setting Time Format	195
3.3.12.	AT+CALD - Delete Alarm	196
3.4.	SMS & CB	197
3.4.1.	AT+CSMS - Select Message Service	197
3.4.2.	AT+CPMS - Preferred Message Storage	199
3.4.3.	AT+CMGF - Message Format	201
3.4.4.	AT+CSCA - Service Center Address	202
3.4.5.	AT+CSMP - Set Text Mode Parameters	204
3.4.6.	AT+CSDH - Show Text Mode Parameters	206
3.4.7.	AT+CSAS - Save Settings	207

3.4.8.	AT+CRES - Restore Settings	208
3.4.9.	AT+CMMS - More Message to Send	209
3.4.10.	AT+CNMI - New Message Indications to Terminal Equipment	210
3.4.11.	AT+CNMA - New Message Acknowledgement	215
3.4.12.	AT+CMGL - List Messages	218
3.4.13.	AT+CMGR - Read Message	222
3.4.14.	AT+CMGS - Send Short Message	226
3.4.15.	AT+CMGW - Write Short Message to Memory	229
3.4.16.	AT+CMGD - Delete Message.....	233
3.4.17.	AT+CGSMS - Select Service for MO SMS Messages	234
3.4.18.	AT#SMSMODE - SMS Commands Operation Mode	235
3.4.19.	AT#CMGLCONCINDEX - Report Concatenated SMS Indexes	236
3.4.20.	AT#E2SMSRI - SMS Ring Indicator	237
3.4.21.	AT#SMOV - SMS Overflow	238
3.4.22.	AT#SMSMOVE - Move Short Message to other Memory	239
3.5.	Phonebook.....	241
3.5.1.	AT+CPBS - Select Phonebook Memory Storage	241
3.5.2.	AT+CPBR - Read Phonebook Entries.....	243
3.5.3.	AT+CPBF - Find Phonebook Entries.....	246
3.5.4.	AT+CPBW - Write Phonebook Entry.....	249
3.5.5.	AT#CPBGR - Read Group Entries	252
3.5.6.	AT#CPBGW - Write Group Entry	254
3.5.7.	AT#CPBD - Delete All Phonebook Entries.....	255
3.6.	Jamming Detection and Report.....	256
3.6.1.	AT#JDRENH2 - Enhanced Jamming Detection and Report.....	256
3.6.2.	AT#JDR4GCFG - LTE Jamming Detection Threshold Configuration.....	259
3.7.	Packet Domain.....	261
3.7.1.	AT+CGQREQ - Quality of Service Profile (Requested).....	261
3.7.2.	AT+CGDCONT - Define PDP Context	263
3.7.3.	AT+CGDSCONT - Define Secondary PDP Context.....	265
3.7.4.	AT+CGSCONTRDP - Secondary PDP Context Read Dynamic Parameters	267
3.7.5.	AT+CGQMIN - Quality of Service Profile (Minimum Acceptable).....	268
3.7.6.	AT+CGPADDR - Show PDP Address	270
3.7.7.	AT+CGCMOD - Modify PDP Context.....	272
3.7.8.	AT#AUTOATT - Auto-Attach Property.....	273
3.7.9.	AT#MSCLASS - Multislot Class Control.....	274
3.7.10.	AT#GAUTH - PPP Data Connection Authentication Type.....	275
3.7.11.	AT+CGAUTH - Define PDP Context Authentication Parameters	276
3.7.12.	AT+CGCONTRDP - PDP Context Read Dynamic Parameters.....	277
3.7.13.	AT+CGPIAF - Printing IP Address Format	279
3.7.14.	AT+CGACT - PDP Context Activate or Deactivate	281
3.7.15.	AT+CGEREP - Packet Domain Event Reporting	282
3.7.16.	AT#PPPCFG - PPP Configuration	284
3.7.17.	AT+CGREG - GPRS Network Registration Status.....	285
3.7.18.	AT+CGATT - PS Attach or Detach.....	288

3.8.	SIM.....	289
3.8.1.	AT+CPIN - Enter the PIN	289
3.8.2.	AT#PCT - Display PIN Counter.....	291
3.8.3.	AT+CCID - Read ICCID	292
3.8.4.	AT+CIMI - International Mobile Subscriber Identity (IMSI)	293
3.8.5.	AT#CIMI - International Mobile Subscriber Identity (IMSI)	294
3.8.6.	AT#SIMDET - SIM Detection Mode	295
3.8.7.	AT#SIMPR - SIM Presence Status	297
3.8.8.	AT#CCID - Read ICCID	299
3.8.9.	AT#QSS - Query SIM Status.....	300
3.8.10.	AT+CRSM - Restricted SIM access	302
3.8.11.	AT+CSIM - Generic SIM Access.....	304
3.8.12.	AT+CCHO - Open Logical Channel	306
3.8.13.	AT+CCHC - Close Logical Channel	308
3.8.14.	AT+CGLA - Generic UICC Logical Channel Access	309
3.8.15.	AT#VSIMSETPROF - Set Virtual SIM profile	311
3.8.16.	AT+ICCID - Read ICCID	312
3.9.	SIM Toolkit	313
3.9.1.	AT#STIA - SIM/USIM Toolkit Interface Action.....	313
3.9.2.	AT#STGI - SIM Toolkit Get Information.....	318
3.9.3.	AT#STSR - SIM Toolkit Send Response.....	326
3.10.	Power Down.....	328
3.10.1.	AT#REBOOT - Module Reboot.....	328
3.10.2.	AT#ENHRST - Periodic Reset	329
3.10.3.	AT#SHDN - Software Shutdown	331
3.10.4.	AT#FASTSHDN - Fast Shutdown Configuration	332
3.11.	HW and Radio Control	334
3.11.1.	AT#CBC - Battery and Charger Status.....	334
3.11.2.	AT#TEMPCFG - Temperature Monitor Configuration	335
3.11.3.	AT#GPIO - General Purpose Input/Output Pin Control	340
3.11.4.	AT#ALARMPIN - Alarm Pin Configuration	344
3.11.5.	AT#SLED - STAT_LED GPIO Setting.....	345
3.11.6.	AT#SLEDSAV - Save STAT_LED GPIO Setting.....	347
3.11.7.	AT#ADC - Read Analog/Digital Converter Input.....	348
3.11.8.	AT#V24CFG - V24 Output Pins Configuration	350
3.11.9.	AT#V24 - V24 Output Pins Control	351
3.11.10.	AT#I2CWR - Write to I2C.....	352
3.11.11.	AT#I2CRD - Read from I2C	354
3.11.12.	AT#I2CCF - Combined Format for I2C Writing and Reading	356
3.11.13.	AT#TEMPMON - Temperature Monitor.....	358
3.11.14.	AT#TESTMODE - Test Mode Configuration	360
3.12.	Mobile Broadband	363
3.12.1.	Ethernet Control Mode (ECM).....	363
3.12.1.1.	AT#ECM - Ethernet Control Model Setup	363
3.12.1.2.	AT#ECMD - ECM Shutdown	364

3.13.	IPEasy.....	365
3.13.1.	AT#SGACT - PDP Context Activation.....	365
3.13.2.	AT#SGACTAUTH - PDP Context Authentication Type.....	367
3.13.3.	AT#SGACTCFG - PDP Automatic Context Activation-Reactivation.....	368
3.13.4.	AT#SGACTCFGEXT - Extended PDP Context Configuration.....	371
3.13.5.	AT#SCFG - Socket Configuration.....	373
3.13.6.	AT#SCFGEXT - Socket Configuration Extended.....	375
3.13.7.	AT#SCFGEXT2 - Socket Configuration Extended 2.....	378
3.13.8.	AT#SKTRST - Socket Parameters Reset.....	381
3.13.9.	AT#SD - Socket Dial.....	382
3.13.10.	AT#SO - Socket Restore.....	385
3.13.11.	AT#SH - Socket Shutdown.....	386
3.13.12.	AT#SL - Socket Listen.....	387
3.13.13.	AT#SLUDP - Socket Listen UDP.....	389
3.13.14.	AT#SA - Socket Accept.....	391
3.13.15.	AT#SEND - Send Data in Command Mode.....	392
3.13.16.	AT#SENDEXT - Send Data in Command Mode extended.....	394
3.13.17.	AT#SRECV - Socket Receive Data in Command Mode.....	396
3.13.18.	AT#SENDUDP - Send UDP Data to a Specific Remote Host.....	398
3.13.19.	AT#SENDUDPEXT - Send UDP Data to a Specific Remote Host EXTENDED.....	400
3.13.20.	AT#SLASTCLOSURE - Detect the Cause of a Socket Disconnection.....	401
3.13.21.	AT#SS - Socket Status.....	403
3.13.22.	AT#SI - Socket Info.....	405
3.13.23.	AT#ST - Socket Type.....	407
3.13.24.	AT#PADCMD - PAD Command Features.....	409
3.13.25.	AT#PADFWD - PAD Forward Character.....	410
3.13.26.	AT#BASE64 - Base64 Encoding/Decoding of Socket Sent/Received Data.....	411
3.13.27.	AT#FRWL - Firewall Setup.....	414
3.13.28.	AT#E2SLRI - Socket Listen Ring Indicator.....	416
3.13.29.	AT#ICMP - Ping Support.....	417
3.13.30.	AT#PING - Send PING Request.....	418
3.13.31.	AT#QDNS - Query DNS.....	420
3.13.32.	AT#CACHEDNS - DNS Response Caching.....	421
3.13.33.	AT#DNS - Manual DNS Selection.....	423
3.13.34.	AT#NWDNS - DNS from Network.....	425
3.13.35.	AT#NTP - Calculate and Update Date and Time with NTP.....	427
3.13.36.	AT#NTPCFG - Configure NTP Parameters.....	429
3.13.37.	AT#GDATAVOL - PS Data Volume.....	430
3.13.38.	AT#SCFGEXT3 - Socket Configuration Extended 3.....	432
3.14.	FTPEasy.....	434
3.14.1.	AT#FTPAPP - FTP Append.....	434
3.14.2.	AT#FTPAPPEXT - FTP Append Extended.....	435
3.14.3.	AT#FTPCLOSE - FTP Close Command.....	437
3.14.4.	AT#FTPCWD - FTP Change Working Directory.....	438
3.14.5.	AT#FTPDELE - FTP Delete.....	439

3.14.6.	AT#FTPFSIZE - Get File Size from FTP Server.....	440
3.14.7.	AT#FTPGET - FTP Get Command	441
3.14.8.	AT#FTPGETPKT - FTP Get in Command Mode.....	442
3.14.9.	AT#FTPLIST - FTP List.....	444
3.14.10.	AT#FTPMSG - FTP Read Message.....	445
3.14.11.	AT#FTPOPEN - FTP Connection Opening	446
3.14.12.	AT#FTPPUT - FTP Send File.....	447
3.14.13.	AT#FTPPWD - FTP Print Working Directory	448
3.14.14.	AT#FTP_RECV - Receive Data in Command Mode	449
3.14.15.	AT#FTPREST - Set Restart Position for FTP GET	451
3.14.16.	AT#FTPTO - FTP Time Out	452
3.14.17.	AT#FTPTYPE - FTP Type.....	453
3.14.18.	AT#FTPCFG - FTP Configuration	454
3.15.	SMTP	456
3.15.1.	AT#ESMTP - E-mail SMTP Server	456
3.15.2.	AT#EMAILMSG - SMTP Read Message.....	457
3.15.3.	AT#SMTPCFG - Configure SMTP Parameters	458
3.15.4.	AT#ERST - E-mail Parameters Reset.....	460
3.15.5.	AT#ESAV - E-mail Parameters Save	461
3.15.6.	AT#EUSER - E-mail Authentication User Name	462
3.15.7.	AT#EMAILD - E-mail Sending.....	463
3.15.8.	AT#EPASSW - E-mail Authentication Password.....	464
3.15.9.	AT#EADDR - E-mail Sender Address	465
3.16.	HTTP	466
3.16.1.	AT#HTTPCFG - Configure HTTP Parameters	466
3.16.2.	AT#HTTPQRY - Send HTTP GET, HEAD or DELETE Request.....	468
3.16.3.	AT#HTTSPND - Send HTTP POST or PUT request.....	470
3.16.4.	AT#HTTPCRV - Receive HTTP Server Data	472
3.17.	SSL	473
3.17.1.	AT#SSLCFG - Configure General Parameters of a SSL Socket.....	473
3.17.2.	AT#SSLSECCFG - Configure Security Parameters of a SSL Socket	475
3.17.3.	AT#SSLEN - Enable a SSL Socket.....	477
3.17.4.	AT#SSLD - Open a SSL Socket to a Remote Server.....	478
3.17.5.	AT#SSLO - Restore a SSL Socket after a +++	481
3.17.6.	AT#SSLH - Close a SSL Socket	482
3.17.7.	AT#SSLSEND - Send Data through a SSL Socket	483
3.17.8.	AT#SSLRECV - Read Data from a SSL Socket.....	484
3.17.9.	AT#SSLS - Report the Status of a SSL Socket.....	486
3.17.10.	AT#SSLI - Secure Socket Info	488
3.17.11.	AT#SSLSENDEXT - Send Data through a SSL Socket in Command Mode	490
3.17.12.	AT#SSLSECDATA - Manage the Security Data	492
3.17.13.	AT#SSLSECCFG2 - Configure Additional Parameters of a SSL Socket	495
3.18.	Easy Scan	496
3.18.1.	AT#CSURV - Network Survey.....	496
3.18.2.	AT#CSURVC - Network Survey (Numeric Format)	500

3.18.3.	AT#CSURVF - Network Survey Format	503
3.18.4.	AT#CSURVNLF - Network Survey CR LF Removing	504
3.18.5.	AT#CSURVEXT - Extended Network Survey.....	505
3.19.	CloT Optimization	506
3.19.1.	AT+CCIOTOPT - CloT Optimization Configuration	506
3.20.	IoT Portal.....	508
3.20.1.	AT#LWM2MSTAT - Telit LwM2M Client Current Status.....	508
3.20.2.	AT#LWM2MMON - Activate/Deactivate the LwM2M Resource	509
3.20.3.	AT#LWM2MENA - Enable/Disable Telit LwM2M Agent	510
3.20.4.	AT#LWM2MACK - Ack for Telit LwM2M Agent.....	514
3.20.5.	AT#LWM2MR - LWM2M Client Resource Reading	515
3.20.6.	AT#LWM2ME - LWM2M Client Resource Executing	517
3.20.7.	AT#LWM2MW - LWM2M Client Resource Writing.....	519
3.20.8.	AT#LWM2MSTS - LWM2STS Bootstrap Server	521
3.20.9.	AT#LWM2MSET - Set LwM2M Whitelisted Resource	523
3.20.10.	AT#LWM2MNEWINST - Create a New Object Instance.....	525
3.20.11.	AT#LWM2MGET - Get LwM2M Whitelisted Resource.....	526
3.21.	Non-IP Data Delivery (NIDD)	528
3.21.1.	AT#NIPDCFG - Define NIDD Parameters.....	528
3.21.2.	AT#NIPDCONN - Open and Close a NIDD Connection.....	529
3.21.3.	AT#NIPDSEND - Send MO Non-IP Data	530
3.21.4.	AT#NIPDRECV - Retrieve Non-IP Data	531
3.22.	FOTA & OMA	532
3.22.1.	FOTA Legacy	532
3.22.1.1.	AT#OTAUPW - OTA Delta Write.....	532
3.23.	M2M	533
3.23.1.	AT#M2MMKDIR - M2M File System Make Directory	533
3.23.2.	AT#M2MBACKUP - M2M Set Backup Feature	534
3.23.3.	AT#M2MRMDIR - M2M File System Remove Directory.....	535
3.23.4.	AT#M2MRUN - M2M Set Run File Permission	536
3.23.5.	AT+M2M - Enable/disable M2M Application execution	539
3.23.6.	AT#M2MWRITE - Write a File.....	540
3.23.7.	AT#M2MDEL - Delete File	541
3.23.8.	AT#M2MLIST - File System List.....	542
3.23.9.	AT#M2MREAD - Read File	543
3.24.	GNSS	544
3.24.1.	GNSS Configuration.....	544
3.24.1.1.	AT\$LCSSLP - Update SLP Address	544
3.24.1.2.	AT\$LCSTER - Update Terminal Information	545
3.24.1.3.	AT\$LICLS - Enable/Disable Unsolicited Response.....	546
3.24.1.4.	AT\$LTC - LCS Certificate.....	547
3.24.1.5.	AT\$LCSLK - Lock Context for LCS Use.....	548
3.24.1.6.	AT\$GPSQOS - GPS Quality of Service	549
3.24.1.7.	AT\$GPSSTOP - Stop Location Service Request.....	551
3.24.1.8.	AT\$GPSLSR - Start Location Service Request	552

3.24.1.9.	AT\$SUPLV - Set the Version of the Supported SUPL	556
3.24.1.10.	AT\$SLP - Update SLP Address	557
3.24.1.11.	AT\$SLPTYPE - Update SLP Type Address	558
3.24.1.12.	AT\$SUPLCFG - Configure SUPL TLS and Hash	559
3.24.1.13.	AT\$LCSLUI - Update Location Information	560
3.24.1.14.	AT\$SUPLSEC - Set the User Plane Secure Transport	561
3.24.2.	GNSS Receiver	562
3.24.2.1.	AT\$GPSAT - GNSS Antenna LNA Control	562
3.24.2.2.	AT\$GPSSAV - Save GPS Parameters Configuration	563
3.24.2.3.	AT\$GPSRST - Restore Default GPS Parameters	564
3.24.2.4.	AT\$GPSP - GNSS Controller Power Management	565
3.24.3.	GNSS General Management	566
3.24.3.1.	AT\$GPSSW - GNSS Software Version	566
3.24.3.2.	AT\$GPSCLR - Clear GPS Data	567
3.24.3.3.	AT\$GPSR - Reset the GPS Controller	568
3.24.3.4.	AT\$GPSAV - GPS Antenna Supply Voltage Readout	569
3.24.3.5.	AT\$GPSGLO - Set the GNSS (or GLONASS) Capability	570
3.24.4.	GNSS Positioning Information	571
3.24.4.1.	AT\$GPSNMUN - Unsolicited NMEA Data Configuration	571
3.24.4.2.	AT\$GPSACP - Get Acquired Position	574
3.24.4.3.	AT\$GPSNMUNEX - Unsolicited NMEA Extended Data Configuration	576
3.25.	PSM (Power Saving Mode)	579
3.25.1.	AT+CPSMS - Power Saving Mode Setting	579
3.25.2.	AT#CPSMS - Power Saving Mode Setting	582
4.	LIST OF ACRONYMS	584
5.	DOCUMENT HISTORY	586

1. INTRODUCTION

1.1. Scope

This document is aimed in providing a detailed specification and a comprehensive listing as a reference for the whole set of AT command.

1.2. Audience

Readers of this document should be familiar with Telit modules and their ease of controlling by means of AT Commands.

1.3. Contact Information, Support

For general contact, technical support services, technical questions and report documentation errors contact Telit Technical Support at:

- TS-EMEA@telit.com
- TS-AMERICAS@telit.com
- TS-APAC@telit.com

Alternatively, use:

<http://www.telit.com/support>

For detailed information about where you can buy the Telit modules or for recommendations on accessories and components visit:

<http://www.telit.com>

Our aim is to make this guide as helpful as possible. Keep us informed of your comments and suggestions for improvements.

Telit appreciates feedback from the users of our information.

1.4. Icons and Text Conventions



SET section – This section provides all information related to SET functionality of involved AT command. If it has got strictly and relevant SET information, these are located at section end.



READ section – This section provides all information related to READ functionality of involved AT command. If it has got strictly and relevant READ information, these are located at section end.



TEST section – This section provides all information related to TEST functionality of involved AT command. If it has got strictly and relevant TEST information, these are located at section end.



Additional info – This section provides any kind of additional and useful information related to the AT command section as well as command exceptions or special behavior cases.



REFERENCE section – This section provides useful references (standards or normative) related to involved AT command.



EXAMPLE section – This section provides useful examples related to involved AT command.



NOTE section – This section provides all information related to involved AT commands. Each note can provide a different level of information: danger, caution/warning and tip/information.



Danger – This information **MUST** be followed or catastrophic equipment failure or bodily injury may occur.



Caution or Warning – Alerts the user to important points about integrating the module, if these points are not followed, the module and end user equipment may fail or malfunction.



Tip or Information – Provides advice and suggestions that may be useful when integrating the module.

All dates are in ISO 8601 format, i.e. YYYY-MM-DD.

2. AT COMMANDS

The Telit wireless module family can be controlled via the serial interface using the standard AT commands.¹ The Telit wireless module family is compliant with:

1. Hayes standard AT command set, to maintain the compatibility with existing SW programs.
2. 3GPP TS 27.007 specific AT command and GPRS specific commands.
3. 3GPP TS 27.005 specific AT commands for SMS (Short Message Service) and CBS (Cell Broadcast Service)

Moreover, Telit wireless module family supports also Telit proprietary AT commands for special purposes. The following is a description of how to use the AT commands with the Telit wireless module family.

2.1. Definitions

The following syntactical definitions apply:

- <CR>** **Carriage return character**, is the command line and result code terminator character, which value, in decimal ASCII between 0 and 255, is specified within parameter **S3**. The default value is 13.
- <LF>** **Linefeed character**, is the character recognized as line feed character. Its value, in decimal ASCII between 0 and 255, is specified within parameter **S4**. The default value is 10. The line feed character is output after carriage return character if verbose result codes are used (**V1** option used) otherwise, if numeric format result codes are used (**V0** option used) it will not appear in the result codes.
- <...>** Name enclosed in angle brackets is a syntactical element. They do not appear in the command line.
- [...]** Optional sub parameter of a command or an optional part of TA information response is enclosed in square brackets. Brackets themselves do not appear in the command line. When sub parameter is not given in AT commands which have a Read command, new value equals to its previous value. In AT commands which do not store the values of any of their sub parameters, and so have not a Read command, which are called *action type* commands, action should be done based on the recommended default setting of the sub parameter.

2.2. AT Command Syntax

The syntax rules followed by Telit implementation of either Hayes AT commands, GSM commands are very similar to those of standard basic and extended AT commands

There are two types of extended command:

- **Parameter type commands.** This type of commands may be "set" (to store a value or values for later use), "read" (to determine the current value or values stored), or "tested" (to determine ranges of values supported). Each of them has a test command (trailing =?) to give information about the type of its sub parameters; they also have a Read command (trailing?) to check the current values of sub parameters.
- **Action type commands.** This type of command may be "executed" or "tested".
 - "executed" to invoke a function of the equipment, which generally involves more than the simple storage of a value for later use
 - "tested" to determine:
 - if sub parameters are associated with the action, the ranges of sub parameters values that are supported; if the command has no sub parameters, issuing the correspondent Test command (trailing =?) raises the result code **"ERROR"**.
Note: issuing the Read command (trailing?) causes the command to be executed.
 - whether or not the equipment implements the Action Command (in this case issuing the correspondent Test command - trailing =? - returns the **OK** result code), and, if sub

¹ The AT is an ATTENTION command and is used as a prefix to other parameters in a string. The AT command combined with other parameters can be set up in the communications package or typed in manually as a command line instruction combined with other parameters can be set up in the communications package or typed in manually as a command line instruction.

parameters are associated with the action, the ranges of sub parameters values that are supported.

Action commands don't store the values of any of their possible sub parameters.

Moreover:

The response to the Test Command (trailing =?) may be changed in the future by Telit to allow the description of new values/functionalities.

If all the sub parameters of a parameter type command **+CMD** are optional, issuing **AT+CMD=<CR>** causes the **OK** result code to be returned and the previous values of the omitted sub parameters to be retained.

2.2.1. String Type Parameters

A string, either enclosed between quotes or not, is a valid string type parameter input. According to V25.ter space characters are ignored on the command line and may be used freely for formatting purposes, unless they are embedded in numeric or quoted string constants; therefore a string containing a space character has to be enclosed between quotes to be considered a valid string type parameter (e.g. typing **AT+COPS=1,0,"A1"** is the same as typing **AT+COPS=1,0,A1**; typing **AT+COPS=1,0,"A BB"** is different from typing **AT+COPS=1,0,A BB**).

A string is always case sensitive.

A small set of commands requires always to write the input string parameters within quotes: this is explicitly reported in the specific descriptions.

2.2.2. Command Lines

A command line is made up of three elements: the **prefix**, the **body** and the **termination character**.

The **command line prefix** consists of the characters "**AT**" or "**at**", or, to repeat the execution of the previous command line, the characters "**A**" or "**a**" or **AT#** or **at#**.

The **termination character** may be selected by a user option (parameter S3), the default being **<CR>**.

The basic structures of the command line are:

- **ATCMD1<CR>** where **AT** is the command line prefix, **CMD1** is the body of a **basic command** (nb: the name of the command never begins with the character "+") and **<CR>** is the command line terminator character
- **ATCMD2=10<CR>** where 10 is a sub parameter
- **AT+CMD1;+CMD2=,10<CR>** These are two examples of **extended commands** (nb: the name of the command always begins with the character "+"). They are delimited with semicolon. In the second command the sub parameter is omitted.
- **+CMD1?<CR>** This is a Read command for checking current sub parameter values
- **+CMD1=?<CR>** This is a test command for checking possible sub parameter values

These commands might be performed in a single command line as shown below:

ATCMD1 CMD2=10+CMD1;+CMD2=,10;+CMD1?;+CMD1=?<CR>

anyway, it is always preferable to separate into different command lines the basic commands and the extended commands; furthermore, it is suggested to avoid placing several action commands in the same command line, because if one of them fails, then an error message is received but it is not possible to argue which one of them has failed the execution.

² The set of proprietary AT commands differentiates from the standard one because the name of each of them begins with either "@", "#", "\$" or "*". Proprietary AT commands follow the same syntax rules as extended commands

If command **V1** is enabled (verbose responses codes) and all commands in a command line has been performed successfully, result code **<CR><LF>OK<CR><LF>** is sent from the TA to the TE, if sub parameter values of a command are not accepted by the TA or command itself is invalid, or command cannot be performed for some reason, result code **<CR><LF>ERROR<CR><LF>** is sent and no subsequent commands in the command line are processed.

If command **V0** is enabled (numeric responses codes), and all commands in a command line has been performed successfully, result code **0<CR>** is sent from the TA to the TE, if sub-parameter values of a command are not accepted by the TA or command itself is invalid, or command cannot be performed for some reason, result code **4<CR>** and no subsequent commands in the command line are processed.

In case of errors depending on ME operation, **ERROR** (or **4**) response may be replaced by **+CME ERROR: <err>** or **+CMS ERROR: <err>**.



The command line buffer accepts a maximum of 400 characters. If this number is exceeded none of the commands will be executed and TA returns **ERROR**.

2.2.2.1. ME Error Result Code - +CME ERROR: <err>

This is NOT a command, it is the error response to +Cxxx 3GPP TS 27.007 commands.

Syntax: **+CME ERROR: <err>**

Parameter: **<err>** - error code can be either numeric or verbose (see +CMEE). The possible values of **<err>** are reported in the table:

Numeric Format ³	Verbose Format ⁴
0	phone failure
1	no connection to phone
2	phone adaptor link reserved
3	operation not allowed
4	operation not supported
5	PH-SIM PIN required
6	PH-FSIM PIN required
7	PH-FSIM PUK required
10	SIM not inserted
11	SIM PIN required
12	SIM PUK required
13	SIM failure
14	SIM busy
15	SIM wrong
16	incorrect password
17	SIM PIN2 required
18	SIM PUK2 required
20	memory full
21	invalid index
22	not found
23	memory failure
24	text string too long
25	invalid characters in text string
26	dial string too long
27	invalid characters in dial string
30	no network service
31	network timeout
32	network not allowed - emergency calls only
34	numeric parameter instead of text parameter
35	text parameter instead of numeric parameter
36	numeric parameter out of bounds
37	text string too short
38	The GPIO Pin is already used

³ Not all modules support the error codes shown in the table.

⁴ There could be small variations in the message depending on the module in use.

Numeric Format ³	Verbose Format ⁴
40	network personalization PIN required
41	network personalization PUK required
42	network subset personalization PIN required
43	network subset personalization PUK required
44	service provider personalization PIN required
45	service provider personalization PUK required
46	corporate personalization PIN required
47	corporate personalization PUK required
49	EAP method not supported
50	Invalid EAP parameter
51	Parameter length error for all Auth commands
52	Temporary error for all Auth command
53	not verified hidden key
100	unknown
103	Illegal MESSAGE
106	Illegal ME
107	GPRS services not allowed
111	PLMN not allowed
112	Location area not allowed
113	Roaming not allowed in this location area
132	service option not supported
133	requested service option not subscribed
134	service option temporarily out of order
148	unspecified GPRS error
149	PDP authentication failure
150	invalid mobile class
257	network rejected request
258	retry operation
259	invalid deflected to number
260	deflected to own number
261	unknown subscriber
262	service not available
263	unknown class
264	unknown network message
273	Minimum TFT per PDP address error
274	Duplicate TFT eval prec index
275	Invalid TFT param combination
277	Invalid number of parameters
278	Invalid Parameter
320	Call index error
321	Call state error
322	Sys state error
323	Parameters error
550	generic undocumented error
551	wrong state
552	wrong mode
553	context already activated
554	stack already active
555	activation failed
556	context not opened
557	can not setup socket
558	can not resolve DN
559	time-out in opening socket
560	can not open socket
561	remote disconnected or time-out
562	connection failed
563	tx error
564	already listening
565	socket disconnection
566	can not resume socket
567	ip version type incompatible
568	ipv6 not enabled
569	
600	Generic undocumented error
601	wrong state

Numeric Format ³	Verbose Format ⁴
602	Can not activate
603	Can not resolve name
604	Can not allocate control socket
605	Can not connect control socket
606	Bad or no response from server
607	Not connected
608	Already connected
609	Context down
612	Resource used by other instance
<hr/>	
613	Data socket yet opened in cmdmode
614	FTP CmdMode data socket closed
615	FTP not connected
616	FTP disconnected
617	FTP read command closed
618	FTP read command error
619	FTP write command closed
620	FTP write command error
621	FTP read data closed
622	FTP read data error
623	FTP write data closed
624	FTP write data error
625	FTP host not found
626	FTP accept failure
627	FTP listen failure
628	FTP bind failure
629	FTP file create failure
630	FTP file get failure
631	FTP file put failure
632	FTP file not found
633	FTP timed out
634	FTP login incorrect
635	FTP close error
636	FTP server not ready
637	FTP server shutdown
638	FTP unexpected reply
639	FTP user ID and password don't match
640	FTP user ID and password don't match
641	FTP user already logged in
642	FTP open channel timeout
643	FTP communication timeout
644	FTP unknown error
<hr/>	
657	Network survey error (No Carrier)
658	Network survey error (Busy)
659	Network survey error (Wrong request)
660	Network survey error (Aborted)
<hr/>	
680	LU processing
681	Network search aborted
682	PTM mode
683	Network search terminated
684	CSG Search processing
<hr/>	
690	Active call state
691	RR connection established
770	SIM invalid
900	No Response for AT Command
<hr/>	
1000	SSL not activated
1001	SSL certs and keys wrong or not stored
1002	SSL generic error
1003	SSL already activated
1004	SSL error during handshake
1005	SSL socket error
1006	SSL invalid state
1007	SSL cannot activate
1008	SSL not connected
1009	SSL already connected
1010	SSL error enc/dec data
1011	SSL disconnected
<hr/>	
1100	Model not recognized
1101	Model information missing

Numeric Format ³	Verbose Format ⁴
1102	Unable to open the file
1103	Unable to close the file
1104	Unable to read the nv file
1105	Unable to write the nv file
1106	Input pattern is wrong
1113	Call establishment failed
1114	File name already exist

2.2.2.2. Message Service Failure Result Code - +CMS ERROR: <err>

This is NOT a command, it is the error response to +Cxxx 3GPP TS 27.005 commands.

Syntax: **+CMS ERROR: <err>**

Parameter: **<err>** - numeric error code.

The **<err>** values are reported in the table:

Numeric Format	Meaning
According to 3GPP TS 24.011 section 8.2.5.4	
0...127	
According to 3GPP TS 23.040 sub clause 9.2.3.22 values	
128...255	
According to 3GPP TS 27.005 section 3.2.5 - Message Service Failure Result Code +CMS ERROR	
300	ME failure
301	SMS service of ME reserved
302	operation not allowed
303	operation not supported
304	invalid PDU mode parameter
305	invalid text mode parameter
310	SIM not inserted
311	SIM PIN required
312	PH-SIM PIN required
313	SIM failure
314	SIM busy
315	SIM wrong
316	SIM PUK required
317	SIM PIN2 required
318	SIM PUK2 required
320	memory failure
321	invalid memory index
322	memory full
330	SMSC address unknown
331	no network service
332	network time-out
340	no +CNMA acknowledgement expected
500	unknown error
510	msg blocked
<err> 512 and on are manufacturer specific	
512	No SM resources
513	TR1M timeout
514	LL error
515	No response from network

2.2.3. Information Responses and Result Codes

The TA response, in case of verbose response format enabled, for the previous examples command line could be as shown below:

- information response to **+CMD1?**
<CR><LF>+CMD1:2,1,10<CR><LF>
- information response to **+CMD1=?**
<CR><LF>+CMD1(0-2),(0,1),(0-15)<CR><LF>
- result code <CR><LF>OK<CR><LF>

Moreover, there are other two types of result codes:

- *result codes* that inform about progress of TA operation (e.g. connection establishment **CONNECT**)
- *result codes* that indicate occurrence of an event not directly associated with issuance of a command from TE (e.g. ring indication **RING**).

Here the basic result codes according to ITU-T V25Ter recommendation

Numeric form	Verbose form
0	OK
1	CONNECT or CONNECT <text>3F3F5
2	RING
3	NO CARRIER
4	ERROR
6	NO DIALTONE
7	BUSY
8	NO ANSWER
10	CONNECT 24004
11	CONNECT 48004
12	CONNECT 96004
15	CONNECT 144004
23	CONNECT 1200/754

2.2.4. Command Response Time-Out

Every command issued to the Telit modules returns a result response, if response codes are enabled (default). The time needed to process the given command and return the response varies, depending on the command type. Commands that do not interact with the SIM or the network, and only involve internal setups or readings, have an immediate response. Commands that interact with the SIM or the network could take many seconds to send a response, depending on SIM configuration (e.g., number of contacts stored in the phonebook, number of stored SMS), or on the network the command may interact with.

2.2.5. Command Issuing Timing

The chain Command -> Response shall always be respected, and a new command must not be issued before the module has terminated all the sending of its response result code (whatever it may be).

This applies especially to applications that "sense" the **OK** text and therefore may send the next command before the complete code <CR><LF>OK<CR><LF> is sent by the module.

It is advisable anyway to wait for at least 20ms between the end of the reception of the response and the issue of the next AT command.

If the response codes are disabled and therefore the module does not report any response to the command, then at least the 20ms pause time shall be respected.

2.3. Storage

2.3.1. Factory Profile and User Profiles

The Telit wireless modules store the values, set by several commands, in the internal nonvolatile memory (NVM), allowing to remember this setting even after power off. In the NVM, these values are set either as factory profile or as user profiles. There are two customizable user profiles and one factory profile in the NVM of the device: by default, the device will start with user profile 0 equal to factory profile.

⁵ <text> can be "300", "1200", "2400", "4800", "9600", "14400" or "1200/75"

For backward compatibility, each profile is divided into two sections, one base section which was historically the one that was saved and restored in early releases of code, and the extended section which includes all the remaining values.

The **&W** command is used to save the current values of both sections of profiles into the NVM user profile. Commands **&Y** and **&P** are both used to set the profile to be loaded at startup. **&Y** instructs the device to load at startup only the base section. **&P** instructs the device to load at startup the full profile: base + extended sections.

The **&F** command resets to factory profile values only the command of the base section of profile, while the **&F1** resets to factory profile values the full set of base + extended section commands.

The values set by other commands are stored in NVM outside the profile: some of them are stored always, without issuing any **&W**, some other are stored issuing specific commands (**+CSAS**, **#SLEDSAV**, **#SKTSAV**, **#ESAV**); all these values are read at power-up.

In this document, each AT command description begins with a "AT Command short overview table" having the following format:

SIM Presence	Setting saved	Can be aborted	MAX timeout	SELINT
/	see below	/	/	/

This chapter focus on the values that **Setting saved** field can assume and their meaning. The meaning of the other fields will be described in the next chapter. **Setting saved** field can have one of the value listed below (to have information on the AT instance introduced hereafter, see the reference section of the **#PORTCFG** command):

- Specific profile** the parameters values set by the command are stored in the profile base section. The stored values set is associated to the specific AT instance used to enter the command. It is a profile used by the specific AT instances.
 Examples of the AT commands: **+IPR, E, Q, V, X, &Y**, etc.
 The parameters values set by the command are stored in the profile extended section. The stored values set is associated to the specific AT instance used to enter the command. It is a profile used by the specific AT instance.
 Examples of the AT commands: **+FCLASS, +CREG, +CLIP, #STIA**, etc.
- Common profile** the parameters values set by the command are stored in the profile extended section. The stored values set is not associated to the specific AT instance used to enter the command. It is a profile shared between the AT instances.
 Examples of the AT commands: **+CALM, #E2SLRI, #DVI**, etc.
- Auto** the parameters values set by the command are automatically stored in NVM, without issuing any storing AT command, and independently from the profile (unique values). The values are automatically restored at startup.
 AT commands examples: **+COPS, +CGQREQ, #SCFG**, etc.
 In some cases, the parameters values are store in the file system.
 AT commands examples: **#TEMPCFG, #TEMPMON**, etc.
- Other** the parameters values set by the command are stored in NVM issuing a specific command and independently from the profile.
 Examples of the AT commands: **#SLED** setting is saved by **#SLEDSAV**
#BIQUADINEX setting is saved by **#PSAV**
 etc.

2.4. AT Command Short Overview Table

As stated before, each AT command description begins with a "AT Command short overview table" having the following format:

SIM Presence	Setting saved	Can be aborted	MAX timeout	SELINT
Not required	/	No	-	2

Here are the table fields meanings:

SIM Presence indicates if the AT command to be executed needs the SIM presence.

Can be aborted indicates if the AT command can be aborted during its execution.

MAX timeout indicates the time within which the command must be executed.

SELINT indicates on which AT interface type the AT command is available.

3. AT COMMANDS REFERENCES

3.1. General Control and Config

3.1.1. Command Line Prefixes

3.1.1.1. AT - Starting a Command Line

AT is the prefix used to start a command line.



ITU-T Recommendation V.25 ter
3GPP TS 27.007

SIM Presence	Setting saved	Can be aborted	MAX timeout	SELINT
Not required	No	No	-	2



AT

The prefix **AT** is a two-character abbreviation ("ATtention"), always used to start a command line to be sent from TE to TA, with the only exception of AT#/ prefix. As a command, it can be issued just to test if the device is responding to AT commands.

3.1.1.2. **A/** - Last Command Automatic Repetition

The command immediately executes the previously issued command or commands.



ITU-T Recommendation V.25 ter



SIM Presence	Setting saved	Can be aborted	MAX timeout	SELINT
Not required	No	No	-	2



A/

If the prefix **A/** is issued, the device immediately executes once again the body of the preceding command line. No editing is possible, and no termination character is necessary. A command line may be repeated multiple times through this mechanism, if desired.

If **A/** is issued before any command line has been executed, the preceding command line is assumed to have been empty (that results in an **OK** result code).

-  This command works only at fixed IPR.
-  The custom prefix **AT#** has been defined: it causes the last command to be executed again too; but it doesn't need a fixed **+IPR**.

3.1.1.3. AT#/ - Repeat Last Command

The command immediately executes the previously issued command or commands.

SIM Presence	Setting saved	Can be aborted	MAX timeout	SELINT
Not required	No	No	-	2



AT#/

If **AT#/** is issued, the device immediately executes once again the body of the preceding command line. No editing is possible, and no termination character is necessary. A command line may be repeated multiple times through this mechanism, if desired.

If **AT#/** is issued before any command line has been executed, the preceding command line is assumed to have been empty (that results in an **OK** result code).

-  This command is the same as **A/** but does not need a fixed **+IPR**.

3.1.2. Generic Modem Control

3.1.2.1. AT#SELINT - Select Interface Style

This command sets the AT command interface style.

SIM Presence	Setting saved	Can be aborted	MAX timeout	SELINT
Not required	Auto	No	-	2



AT#SELINT=[<v>]

Set command sets the AT command interface style depending on parameter.

Parameter:

Name	Type	Default	Description
<v>	integer	2	AT command interface style

Value:

2 : standard AT parser



AT#SELINT?

Read command reports the current interface style in the format:

#SELINT: <v>



AT#SELINT=?

Test command reports the available range of values for parameter <v>.

3.1.2.2. AT&F - Set to Factory-Defined Configuration

Set configuration parameters to default values.



ITU-T Recommendation V.25 ter

SIM Presence	Setting saved	Can be aborted	MAX timeout	SELINT
Not required	No	No	-	2



AT&F[<value>]

Execution command sets the configuration parameters to default values specified by manufacturer; it takes in consideration hardware configuration switches and other manufacturer-defined criteria.

Parameter:

Name	Type	Default	Description
<value>	integer	0	parameters to reset

Values:

- 0 : only the factory profile base section parameters are considered
- 1 : either the factory profile base section and the extended section are considered (full factory profile)



If parameter <value> is omitted, the command has the same behavior as **AT&F0**.

3.1.2.3. ATZ - Soft Reset

Soft Reset



ITU-T Recommendation V.25 ter

SIM Presence	Setting saved	Can be aborted	MAX timeout	SELINT
Not required	No	No	-	2



ATZ[<n>]

Execution command loads the base section of the specified user profile and the extended section of the default factory profile

Parameter:

Name	Type	Default	Description
<n>	integer	N/A	user profile number

Value:

0,1 : user profile number

- i** If parameter <n> is omitted, the command has the same behavior as **ATZ0**
- i** Any active call is terminated.

3.1.2.4. AT&Y - Default Reset Basic Profile Designation

Basic profile on startup.

SIM Presence	Setting saved	Can be aborted	MAX timeout	SELINT
Not required	Specific profile	No	-	2



AT&Y=[<n>]

Set command defines the basic profile that will be loaded on startup. The wireless module can store 2 complete configurations (see **&W**).

Parameter:

Name	Type	Default	Description
<n>	integer	0	basic profile that will be loaded on startup.

Value:

0,1 : profile index

- i** Differently from command **Z<n>**, which loads just once the desired profile, the one chosen through command **&Y** will be loaded on every startup.
- i** If parameter is omitted the command has the same behavior as **AT&Y0**.

3.1.2.5. AT&P - Default Reset Full Profile Designation

Define which full profile is loaded at startup.

SIM Presence	Setting saved	Can be aborted	MAX timeout	SELINT
Not required	Auto	No	-	2



AT&P[<n>]



Execution command defines which full profile will be loaded at startup.

Parameter:

Name	Type	Default	Description
<n>	integer	0	Configuration parameter

Value:

0,1 : profile number: the wireless module can store 2 full configurations (see command &W).

-  Differently from command **Z<n>**, which loads just once the desired profile, the one chosen through command **&P** will be loaded at every startup.
-  If parameter is omitted, the command has the same behavior as **AT&P0**

3.1.2.6. AT&W - Store Current Configuration

Execution command stores on profile <n> the complete configuration of the device.

SIM Presence	Setting saved	Can be aborted	MAX timeout	SELINT
Not required	No	No	-	2



AT&W[<n>]

Parameter:

Name	Type	Default	Description
<n>	integer	0	profile identifier
Value:			
0,1 : profile identifiers			

- i** If parameter is omitted, the command has the same behavior of **AT&W0**.

3.1.2.7. AT&N - Display Internal Phonebook Stored Numbers

The command displays telephone numbers stored in the internal phonebook.

SIM Presence	Setting saved	Can be aborted	MAX timeout	SELINT
Not required	No	No	-	2



AT&N[<n>]

The module has a built in nonvolatile memory where 10 telephone numbers can be stored, each one having a maximum of 24 digits.

Execution command returns the telephone number stored at the <n> position in the internal memory.

Parameter:

Name	Type	Default	Description
<n>	integer	N/A	phonebook record number

Value:

0÷9 : phonebook record number

- i** If parameter <n> is omitted then all the internal records are shown.

3.1.2.8. AT#Z - Extended Reset

Set command loads both base section and extended section of the specified user profile stored with **AT&W** and selected with **AT&P**.

SIM Presence	Setting saved	Can be aborted	MAX timeout	SELINT
Not required	No	No	-	2



AT#Z=<profile>

Parameter:

Name	Type	Default	Description
<profile>	integer	0	Parameter to select the user profile

Values:

- 0 : user profile 0
- 1 : user profile 1



AT#Z=?

Test command returns **OK** result code.

3.1.2.9. AT&V - Display some Configuration and Profile

The command displays some of the basic modem configuration settings and parameters

SIM Presence	Setting saved	Can be aborted	MAX timeout	SELINT
Not required	No	No	-	2



AT&V

Execution command returns some of the basic modem configuration settings and parameters, one for each row, in the format:

setting/parameter : value

- i** The row of information about **CTS (C106) OPTIONS** is in the output of **&V** for compatibility reasons and represents only a dummy value.



Example of returned values.

- AT&V**
COMMAND ECHO : E1=YES
RESULT MESSAGES : Q0=YES
VERBOSE MESSAGES : V1=YES
EXTENDED MESSAGES : X1=YES
LINE SPEED : F0=autodetect
CONSTANT DTE SPEED : YES
FLOW CONTROL OPTIONS : &K3=HW bidirect.
ERROR CORRECTION MODE : RLP
CTS (C106) OPTIONS : &B2=OFF while disc.
DSR (C107) OPTIONS : &S3=PHONE ready->ON
DTR (C108) OPTIONS : &D0=ignored
DCD (C109) OPTIONS : &C1=follows carrier
RI (C125) OPTIONS : \R1=OFF dur. off-hk
C108/1 OPERATION : &D0=NO
POWER SAVING ON DTR : +CFUN:1=NO
DEFAULT PROFILE : &Y0=user profile 1
OK

3.1.2.10. AT+GCI - Country of Installation

Set command allows to select the installation country code according to ITU-T Annex A.



ITU-T Recommendation V.25 ter

SIM Presence	Setting saved	Can be aborted	MAX timeout	SELINT
Not required	No	No	-	2



AT+GCI=<code>

Parameter:

Name	Type	Default	Description
<code>	integer	59	installation country code

Value:

59 : it currently supports only the Italy country code



AT+GCI?

Read command reports the currently selected country code.



AT+GCI=?

Test command reports the supported values of parameter <code>.

3.1.2.11. AT+GCAP - Capabilities List

This command returns the equipment supported command set list.



ITU-T Recommendation V.25 ter

SIM Presence	Setting saved	Can be aborted	MAX timeout	SELINT
Not required	No	No	-	2



AT+GCAP

Execution command returns the equipment supported command set list:

+GCAP: +CGSM

Additional info:

▶▶ Supported Command Set:

+CGSM: GSM ETSI command set



AT+GCAP=?

Test command returns **OK** result code.

3.1.2.12. AT+GMI - Manufacturer Identification

This command returns the manufacturer identification.



ITU-T Recommendation V.25 ter

SIM Presence	Setting saved	Can be aborted	MAX timeout	SELINT
Not required	No	No	-	2



AT+GMI

Execution command returns the manufacturer identification followed by an <OK> at newline.



AT+GMI=?

Test command returns **OK** result code.

3.1.2.13. AT+GMM - Model Identification

The command returns the model identification.



ITU-T Recommendation V.25 ter

SIM Presence	Setting saved	Can be aborted	MAX timeout	SELINT
Not required	No	No	-	2



AT+GMM

The execution command returns the model identification followed by an <OK> at newline.



AT+GMM=?

Test command returns OK result code.

3.1.2.14. AT+GMR - Revision Identification

The command returns the software revision identification.



ITU-T Recommendation V.25 ter

SIM Presence	Setting saved	Can be aborted	MAX timeout	SELINT
Not required	No	No	-	2



AT+GMR

Execution command returns the software revision identification followed by an <OK> at newline.



AT+GMR=?

Test command returns **OK** result code.

3.1.2.15. AT+GSN - Serial Number

The command reports the device board serial number.



ITU-T Recommendation V.25 ter

SIM Presence	Setting saved	Can be aborted	MAX timeout	SELINT
Not required	No	No	-	2



AT+GSN

Execution command returns the device board serial number.



The number returned is not the IMSI, but it is the board number.



AT+GSN=?

Test command returns **OK** result code.

3.1.2.16. AT+CGMI - Request Manufacturer Identification

The command returns device manufacturer identification code.



3GPP TS 27.007

SIM Presence	Setting saved	Can be aborted	MAX timeout	SELINT
Not required	No	No	-	2



AT+CGMI

Execution command returns the device manufacturer identification code followed by an **OK** at newline.



AT+CGMI=?

Test command returns **OK** result code.

3.1.2.17. AT+CGMM - Request Model Identification

This command returns the device model identification.



3GPP TS 27.007

SIM Presence	Setting saved	Can be aborted	MAX timeout	SELINT
Not required	Auto	No	-	2



AT+CGMM

Execution command returns the device model identification code followed by an **OK** at newline.



AT+CGMM=?

Test command returns **OK** result code.

3.1.2.18. AT+CGMR - Request Revision Identification

The command returns device software revision number.



3GPP TS 27.007

SIM Presence	Setting saved	Can be aborted	MAX timeout	SELINT
Not required	No	No	-	2



AT+CGMR

Execution command returns device software revision number followed by an **OK** at newline.



AT+CGMR=?

Test command returns **OK** result code.

3.1.2.19. AT+CGSN - Request Product Serial Number Identification

This command allows to retrieve the product serial number in form of IMEI of the mobile.



3GPP TS 27.007

SIM Presence	Setting saved	Can be aborted	MAX timeout	SELINT
Not required	No	No	-	2



AT+CGSN

Execution command returns the product serial number in form of IMEI of the mobile followed by an **OK** at newline.



AT+CGSN=?

Test command returns **OK** result code.

3.1.2.20. AT#CGMI - Request Manufacturer Identification

The command returns device manufacturer identification code.

SIM Presence	Setting saved	Can be aborted	MAX timeout	SELINT
Not required	No	No	-	2



AT#CGMI

Execution command returns the device manufacturer identification code, with command echo.

The response is as follows

#CGMI: <code>

OK



AT#CGMI=?

Test command returns **OK** result code.

3.1.2.21. AT#CGMR - Request Revision Identification

The command returns device software revision number.

SIM Presence	Setting saved	Can be aborted	MAX timeout	SELINT
Not required	No	No	-	2



AT#CGMR

Execution command returns device software revision number, with command echo.

The response is as follows

#CGMR: <num>

OK



AT#CGMR=?

Test command returns **OK** result code.

3.1.2.22. AT#CGSN - Product Serial Number Identification

The execution command returns the product serial number, in form of IMEI of the mobile, with **#CGSN:** command echo.

SIM Presence	Setting saved	Can be aborted	MAX timeout	SELINT
Not required	No	No	-	2



AT#CGSN

The command returns the following message:

```
AT#CGSN
#CGSN: <product serial number>
OK
```



AT#CGSN=?

The test command returns the **OK** result code.

3.1.2.23. AT#CGMF - Request Product Code

Execution command returns the device product code without **#CGMF:** command echo.

SIM Presence	Setting saved	Can be aborted	MAX timeout	SELINT
Not required	No	No	-	2



AT#CGMF

The command returns the following message:

```
AT#CGMF  
<productCode>  
  
OK
```



AT#CGMF=?

Test command returns **OK** result code.

3.1.2.24. AT#SWPKGV - Request Software Package Version

This command allows to retrieve the software package version.

SIM Presence	Setting saved	Can be aborted	MAX timeout	SELINT
Not required	No	No	-	2



AT#SWPKGV

Execution command returns the software package version without **#SWPKGV:** command echo. The response is as follows:

```
AT#SWPKGV
<Telit Software Package Version>-<Production Parameters Version>
<Modem Package Version>
<Production Parameters Version>
<Application Software Version>
```

OK



AT#SWPKGV=?

Test command returns **OK** result code.

3.1.2.25. AT+CPAS - Phone Activity Status

Execution command reports the device status in the form shown in Additional info section.



3GPP TS 27.007

SIM Presence	Setting saved	Can be aborted	MAX timeout	SELINT
Not required	No	No	-	2



AT+CPAS

Additional info:

- ▶▶ Message format returned by the execution command:

+CPAS: <pas>

Name	Type	Default	Description
<pas>	integer	0	phone activity status.

Values:

- 0 : ready (device allows commands from TA/TE)
- 3 : ringing (device is ready for commands from TA/TE, but the ringer is active)
- 4 : call in progress (device is ready for commands from TA/TE, but a call is in progress)



AT+CPAS=?

Test command reports the supported range of values for <pas>.

- i** Although **+CPAS** is an execution command, 3GPP TS 27.007 requires the Test command to be defined.

3.1.2.26. AT+CFUN - Set Phone Functionality

This command selects the level of functionality in the ME.



3GPP TS 27.007

SIM Presence	Setting saved	Can be aborted	MAX timeout	SELINT
Not required	Specific profile	No	-	2



AT+CFUN=[<fun>[,<rst>]]

Set command selects the level of functionality in the ME.

Parameters:



Name	Type	Default	Description
<fun>	integer	1	Power saving function mode.
Values:			
0	:	NON-CYCLIC SLEEP mode, see Additional info section.	
1	:	mobile full functionality with power saving disabled.	
2	:	disable TX, not supported	
4	:	disable both TX and RX	
5	:	same as <fun>=1	
6	:	module reboot	
7	:	OFF line mode. This mode cannot be set, can only be read using the read command.	
8	:	FTM. This mode cannot be set, can only be read using the read command.	
<rst>	integer	0	reset flag
Values:			
0	:	do not reset the ME before setting it to <fun> functionality level.	
1	:	reset the ME before setting it to <fun> functionality level, this option works only with <fun> =1, with other it will return an error	

Additional info:

▶▶ <fun>=0

NON-CYCLIC SLEEP mode, minimum functionality: the AT interface is not accessible by UART. Consequently, once you have set <fun>=0, do not send further characters. Otherwise these characters remain in the input buffer and may delay the output of an unsolicited result code. The first wake-up event stops power saving and takes the ME back to full functionality level <fun>=1.

i Issuing **AT+CFUN=4[,0]** causes the module to perform either a network deregistration and a SIM deactivation.

-
-  If power saving is enabled, it reduces the power consumption during the idle time, thus allowing a longer standby time with a given battery capacity.
 -  To place the module in power saving mode, disconnect the USB and set the DTR (RS232) line to OFF. Once in power saving, the CTS line switches to the OFF status to signal that the module is in power saving status. During the power saving, before sending any AT command on the serial line, enable the DTR line and wait for the CTS (RS232) line to go in ON status. While the DTR line is ON, the module will not return back in the power saving condition.
When the module detects USB port is connected, then the power saving mode is not allowed.
 -  The power saving function does not affect the network behavior of the module, even during the power save condition the module remains registered on the network and reachable for incoming calls or SMS. If a call comes during the power save, then the module will wake up and proceed normally with the unsolicited incoming call code.
-

**AT+CFUN?**

Read command reports the current setting of **<fun>** in the format

+CFUN: <fun>

**AT+CFUN=?**

Test command returns the list of supported values for **<fun>** and **<rst>**.

3.1.2.27. AT+CIND - Indicator Control

This command is used to control the registration state of modem indicators.



3GPP TS 27.007

SIM Presence	Setting saved	Can be aborted	MAX timeout	SELINT
Not required	Specific profile	No	-	2



AT+CIND=[<state>[,<state>[,...]]]

Set command is used to control the registration state of ME indicators, in order to automatically send the **+CIEV** URC, whenever the value of the associated indicator changes. The supported indicators (<descr>) and their order appear from test command **AT+CIND=?**

Parameter:

Name	Type	Default	Description
<state>	integer	1	registration state

Values:

- 0 : the indicator is deregistered; there's no unsolicited result code (+CIEV URC) automatically sent by the modem to the application, whenever the value of the associated indicator changes; the value can be directly queried with +CIND?
- 1 : the indicator is registered: an unsolicited result code (+CIEV URC) is automatically sent by the modem to the application, whenever the value of the associated indicator changes; it is still possible to query the value through AT+CIND?

- When the modem is switched on all of the indicators are in registered mode.
- See also command **+CMER**



AT+CIND?

Read command returns the current value of ME indicators, in the format:

+CIND: <ind>[,<ind>[,...]]

Additional info:

- ▶▶ Read command response parameter

Name	Type	Default	Description
<ind>	integer	-	indicator value, which shall be in range of corresponding <descr>. See test command AT+CIND=?

i The order of the values <ind>s is the one returned by test command **AT+CIND=?**



AT+CIND=?

Test command returns pairs, where string value <descr> is a description of the indicator and compound value is the supported values for the indicator, in the format:

+CIND: ((<descr>, (list of supported <ind>s)),(<descr>, (list of supported <ind>s)))[,...]]

Additional info:

▶▶ Test command response parameters

Name	Type	Default	Description
<descr>	string	N/A	indicators names, maximum 16 chars long
Values:			
"battchg"	:	battery charge level; indicator <ind> in the range 0...5, or 99 (not measurable)	
"signal"	:	signal quality; indicator <ind> in the range 0...7, or 99 (not measurable); same as bit error rate (<ber>) in +CSQ command	
"service"	:	service availability; indicator <ind> is 0 (not registered to any network) or 1 (registered)	
"sounder"	:	sounder activity; indicator <ind> is 0 (no sound activity) or 1 (sound activity)	
"message"	:	message received; indicator <ind> is 0 (no unread SMS in memory "SM") or 1 (unread SMS in memory "SM")	
"call"	:	call in progress; indicator <ind> is 0 (no calls in progress) or 1 (at least a call has been established)	
"roam"	:	roaming; indicator <ind> is 0 (registered to home network, or not registered) or 1 (registered to other network)	
"smsfull"	:	SMS memory status; indicator <ind> is 0 (memory locations available) or 1 (an SMS storage in the modem is full)	
"rssi"	:	received signal strength level; indicator <ind> values are 0 (signal strength under -112dBm), from 1 to 4 (signal strength from -97 to -66 dBm, in 15 dBm steps), 5 (signal strength greater than -51 dBm), or 99 (not measurable)	
"GPRS coverage"	:	there is packet service coverage; indicator <ind> is 0 (no packet service) or 1 (module attached to a packet service)	
"callsetup"	:	call setup status indicator; indicator <ind> values are 0 (no active call setup), 1 (MT call is ringing), 2 (MO call was initiated), 3 (MO call ringing at called party)	



Next command causes all the indicators to be registered

AT+CIND=1,1,1,1,1,1,1,1,1

Next command causes all the indicators to be de-registered

AT+CIND=0,0,0,0,0,0,0,0,0

Next command to query the current value of all indicators

AT+CIND?

CIND: 4,0,1,0,0,0,0,2,0

OK

3.1.2.28. AT+CMER - Mobile Equipment Event Reporting

This command configures sending of unsolicited result codes from TA to TE.



3GPP TS 27.007

SIM Presence	Setting saved	Can be aborted	MAX timeout	SELINT
Not required	Specific profile	No	-	2





AT+CMER=[<mode>[,<keyp>[,<disp>[,<ind>[,<bfr>]]]]]

Set command enables/disables sending of unsolicited result codes from TA to TE in the case of indicator state changes.

Parameters:

Name	Type	Default	Description
<mode>	integer	0	controls the processing of unsolicited result codes
Values:			
0	:	buffer +CIEV Unsolicited Result Codes	
1	:	discard +CIEV Unsolicited Result Codes when TA-TE link is reserved (e.g. on-line data mode); otherwise forward them directly to the TE	
2	:	buffer +CIEV Unsolicited Result Codes in the TA when TA-TE link is reserved (e.g. on-line data mode) and flush them to the TE after reservation; otherwise forward them directly to the TE	
3	:	forward +CIEV Unsolicited Result Codes directly to the TE; when TA is in on-line data mode each +CIEV URC is stored in a buffer; once the ME goes into command mode (after +++ was entered), all URCs stored in the buffer will be output	
<keyp>	integer	0	keypad event reporting
Value:			
0	:	No keypad event reporting	
<disp>	integer	0	display event reporting
Value:			
0	:	no display event reporting	
<ind>	integer	0	indicator event reporting
Values:			
0	:	no indicator event reporting	
2	:	indicator event reporting	
<bfr>	integer	0	TA buffer clearing
Values:			
0	:	TA buffer of unsolicited result codes is cleared when <mode> 1..3 is entered	

-
- 1 : TA buffer of unsolicited result codes is flushed to the TE when <mode> 1...3 is entered (OK response shall be given before flushing the codes)
-

-  Sending of URCs in the case of key pressings or display changes are currently not implemented.
 -  After **+CMER** has been switched on with e.g. **AT+CMER=2,0,0,2** command (i.e. <bfr> is 0), URCs for all registered indicators will be issued only first time, if previous <mode> was 0, for backward compatibility. Values shown by the indicators will be current indicators values, not buffered ones. Subsequent **+CMER** commands with <mode> different from 0 and <bfr> equal to 0 will not flush the codes, even if <mode> was set again to 0 before. To flush the codes, <bfr> must be set to 1.
 -  Although it is possible to issue the command when SIM PIN is pending, it will answer **ERROR** if "message" or "smsfull" indicators are enabled in **+CIND**, because with pending PIN it is not possible to give a correct indication about SMS status. To issue the command when SIM PIN is pending you have to disable "message" and "smsfull" indicators in **+CIND** first.
-



AT+CMER?

Read command returns the current setting of parameters, in the format:

+CMER: <mode>,<keyp>,<disp>,<ind>,<bfr>



AT+CMER=?

Test command returns the range of supported values for parameters <mode>, <keyp>, <disp>, <ind>, <bfr>, in the format:

+CMER: (list of supported <mode>s),(list of supported <keyp>s), (list of supported <disp>s),(list of supported <ind>s),(list of supported <bfr>s)

3.1.2.29. AT+CSVM - Set Voice Mail Number

Command to set voice mail server number.

SIM Presence	Setting saved	Can be aborted	MAX timeout	SELINT
Required	Specific profile	No	-	2



AT+CSVM=<mode>[,<number>[,<type>]]

Set command is dummy. It only checks for parameters values validity; it does not send any actual write request to SIM to update voice mail number, nor sends any request to network to enable/disable voice mail.

Parameters:

Name	Type	Default	Description
<mode>	integer	1	enable/disable voice mail number
Values:			
0	:	disable the voice mail number	
1	:	enable the voice mail number	
<number>	string	-	string type phone number of format specified by <type>
<type>	integer	129	type of address octet in integer format
Values:			
129	:	unknown type of number and ISDN/Telephony numbering plan	
145	:	international type of number and ISDN/Telephony numbering plan (contains the character "+")	



AT+CSVM?

Read command returns the currently selected voice mail number and the status (i.e. enabled/disabled) in the format

+CSVM:<mode>,<number>,<type>



AT+CSVM=?

Test command reports the range for the parameters <mode> and <type>.

3.1.2.30. AT#MBN - Mailbox Numbers

This command returns the mailbox numbers stored on SIM.

SIM Presence	Setting saved	Can be aborted	MAX timeout	SELINT
Required	Auto	No	-	2



AT#MBN

Execution command returns the mailbox numbers stored on SIM, if this service is provided by the SIM.

The response is in the format:

```
[#MBN: <index>,<number>,<type>[,<text>][,<mboxtype>][<CR><LF>
#MBN: <index>,<number>,<type>[,<text>][,<mboxtype>][...]]]
```

Additional info:

- ▶▶ The response has its fields described below.

Name	Type	Default	Description
<index>	integer	-	record number
<number>	string	-	string type mailbox number in the format <type>
<type>	integer	N/A	type of mailbox number octet in integer format
Values:			
129	:	national numbering scheme	
145	:	international numbering scheme (contains the character "+")	
<text>	string	-	the alphanumeric text associated to the number; used character set should be the one selected with command +CSCS
<mboxtype>	string	N/A	the message waiting group type of the mailbox, if available
Values:			
VOICE	:	voice	
FAX	:	fax	
EMAIL	:	electronic mail	
OTHER	:	other	

- If all queried locations are empty (but available), no information text lines will be returned.



AT#MBN=?

Test command returns the **OK** result code.

3.1.2.31. AT#MWI - Message Waiting Indication

This command enables/disables the presentation of the Message Waiting Indicator (MWI) URC.

SIM Presence	Setting saved	Can be aborted	MAX timeout	SELINT
Required	Specific profile	No	-	2



AT#MWI=[<enable>]

Set command enables/disables the presentation of the Message Waiting Indicator URC, it can have two formats, as show in Additional info.

Parameter:

Name	Type	Default	Description
<enable>	integer	1	enables/disables the presentation of the #MWI: URC

Values:

- 0 : disables the presentation of the #MWI: URC
- 1 : enables the presentation of the #MWI: URC, see Additional info.

Additional info:

- ▶▶ If **AT#MWI=1** has been entered, the **#MWI: URC** is displayed each time
 - a new message waiting indicator is received from the network, the URC format is:
#MWI: <status>,<indicator>[,<count>]
 - the module is powered on, the URC reports the status of the message waiting indicators, as they are currently stored on SIM, the format is:
**#MWI: <status>[,<indicator>[,<count>]][<CR><LF>
#MWI: <status>,<indicator>[,<count>][...]]]**

The parameters are described in the unsolicited fields section for each URC format.

Unsolicited fields:

Name	Type	Description
<status>	integer	indicates clear or set action when it is received from the network. Values: 0 : clear: has been deleted one of the messages related to the indicator <indicator>. 1 : set: there is a new waiting message related to the indicator <indicator>
<status>	integer	indicates the status when it is read from SIM. Values: 0 : no waiting message indicator is currently set. In this case no other information is reported.

		1 : there are waiting messages related to the message waiting indicator <indicator>
<indicator>	integer	message indicator has the same meaning regardless if it comes from network or it is read from SIM. Values: 1 : either Line 1 (CPHS context) or Voice (3GPP context) 2 : Line 2 (CPHS context only) 3 : Fax 4 : E-mail 5 : Other
<count>	integer	network information reporting the number of pending messages related to the message waiting indicator <indicator>.
<count>	integer	number of pending messages related to the message waiting indicator <indicator> as it is stored on SIM

 Entering **AT#MWI=** returns **OK** but has no effect.



AT#MWI?

Read command reports whether the presentation of the message waiting indicator URC is currently enabled or not, and the status of the message waiting indicators as they are currently stored on SIM. The format is:

```
#MWI: <enable>,<status>[,<indicator>[,<count>]][<CR><LF>
#MWI: <enable>,<status>,<indicator>[,<count>][...]]
```



AT#MWI=?

Test command returns the range of available values for parameter <enable>.

3.1.2.32. AT+CLAC - Available AT Commands

This command shows the available AT commands list.



3GPP TS 27.007

SIM Presence	Setting saved	Can be aborted	MAX timeout	SELINT
Required	No	No	-	2



AT+CLAC

The execution command causes the ME to return one or more lines reporting the AT commands that are available to the user. The format is:

<ATcmd1>[<CR><LF><ATcmd2>[...]]

<ATcmdn> is the AT command.



AT+CLAC=?

Test command returns the OK result code.

3.1.2.33. AT#LANG - Select Language

Set command selects the currently used language for displaying different messages.

SIM Presence	Setting saved	Can be aborted	MAX timeout	SELINT
Not required	No	No	-	2



AT#LANG=<lan>

Parameter:

Name	Type	Default	Description
<lan>	string	en	Selected language

Values:

en : English
it : Italian



AT#LANG?

Read command reports the currently selected <lan> in the format:

#LANG: <lan>



AT#LANG=?

Test command reports the supported range of values for parameter <lan>.

3.1.2.34. AT+CMEE - Report Mobile Equipment Error

The command enables the use of result code.



3GPP TS 27.007

SIM Presence	Setting saved	Can be aborted	MAX timeout	SELINT
Not required	Specific profile	No	-	2



AT+CMEE=[<n>]



Set command disables/enables the use of result code **+CME ERROR: <err>** as an indication of an error relating to the **+Cxxx** command issued. When enabled, device related errors cause the **+CME ERROR: <err>** final result code instead of the default **ERROR** final result code. **ERROR** is returned normally when the error message is related to syntax, invalid parameters or DTE functionality.

Parameter:

Name	Type	Default	Description
<n>	integer	0	enables/disables +CME ERROR: <err> result code and selects the format

Values:

- 0 : disable
- 1 : enable and use numeric<err> values
- 2 : enable and use verbose <err> values

-  The detailed description of <err> is available in section "ME Error Result Code - +CME ERROR: <err>".
-  **+CMEE** has no effect on the final result code **+CMS**.



AT+CMEE?

Read command returns the current value of parameter <n> in the format:

+CMEE: <n>



AT+CMEE=?

Test command returns the supported values of parameter <n>.

3.1.2.35. AT+CEER - Extended Error Report

Reports extended error related to the last unsuccessful call.



3GPP TS 27.007

SIM Presence	Setting saved	Can be aborted	MAX timeout	SELINT
Not required	Auto	No	-	2



AT+CEER

Execution command returns one or more lines of information text **<report>** offering the TA user an extended error report, in the format:

+CEER: <report>

This report regards some error condition that may occur:

- the failure in the last unsuccessful call setup (originating or answering)
- the last call release



If no error condition has occurred since power up, then **"Normal, unspecified"** condition is reported



AT+CEER=?

Test command returns **OK** result code.

3.1.2.36. AT#CEER - Extended Numeric Error Report

The command is related to extended numeric error report.



3GPP TS 24.008

SIM Presence	Setting saved	Can be aborted	MAX timeout	SELINT
Not required	Auto	No	-	2



AT#CEER

Execution command causes the TA to return a numeric code in the intermediate response format:

#CEER: <code>

which offers the user of the TA a report of the reason for

- the last unsuccessful GPRS attach or unsuccessful PDP context activation;
- the last GPRS detach or PDP context deactivation.

Additional info:

- ▶▶ Intermediate response parameters:

Name	Type	Default	Description
<code>	integer	-	error code. Table below show the error codes range and the related meanings.

- ▶▶ [Error codes table](#)

Value	Diagnostic
0	No error
31	Normal, unspecified
	GPRS related errors
224	MS requested detach
225	NWK requested detach
226	Unsuccessful attach cause NO SERVICE
227	Unsuccessful attach cause NO ACCESS
228	Unsuccessful attach cause GPRS SERVICE REFUSED
229	PDP deactivation requested by NWK
230	PDP deactivation cause LLC link activation Failed
231	PDP deactivation cause NWK reactivation with same TI
232	PDP deactivation cause GMM abort
233	PDP deactivation cause LLC or SNDSCP failure
234	PDP unsuccessful activation cause GMM error
235	PDP unsuccessful activation cause NWK reject
236	PDP unsuccessful activation cause NO NSAPI available
237	PDP unsuccessful activation cause SM refuse
238	PDP unsuccessful activation cause MMI ignore
239	PDP unsuccessful activation cause Nb Max Session Reach

256	PDP unsuccessful activation cause wrong APN
257	PDP unsuccessful activation cause unknown PDP address or type
258	PDP unsuccessful activation cause service not supported
259	PDP unsuccessful activation cause QOS not accepted
260	PDP unsuccessful activation cause socket error

-  If none of the previous conditions has occurred since power up, then **<code>=0** is reported (i.e. No error, see table above)

**AT#CEER=?**

Test command returns **OK** result code.

3.1.2.37. AT#PSMRI - Power Saving Mode Ring Indicator

The command enables or disables the Ring Indicator pin response to an URC message while modem is in power saving mode.

SIM Presence	Setting saved	Can be aborted	MAX timeout	SELINT
Required	Common profile	No	-	2



AT#PSMRI=<n>



Set command enables/disables the Ring Indicator pin response to an URC message while modem is in power saving mode. If enabled, a negative going pulse is generated, when URC message for specific event is invoked. The duration of this pulse is determined by the value of <n>.

Parameter:

Name	Type	Default	Description
<n>	integer	0	disables, enables/sets duration of the generated pulse.

Values:

- 0 : disables RI pin response for URC message
- 50÷1150 : enables RI pin response for URC messages with a duration specified in ms

-  When RING signal from incoming call/SMS/socket listen is enabled, the behavior for #PSMRI will be ignored.
-  The behavior for #PSMRI is invoked only when modem is in sleep mode AT+CFUN=5.



AT#PSMRI?

Read command reports the duration in ms of the pulse generated, in the format:

#PSMRI: <n>



AT#PSMRI=?

Test command reports the supported range of values for parameter <n>



The value set by command is stored in the profile extended section and doesn't depend on the specific AT instance used to enter the command.

3.1.2.38. AT+CSCS - Select TE Character Set

The command purpose is to set different character sets that are used by the device.



3GPP TS 27.007

SIM Presence	Setting saved	Can be aborted	MAX timeout	SELINT
Required	Specific profile	No	-	2



AT+CSCS=[<chset>]

Set command sets the current character set used by the device.

Parameter:

Name	Type	Default	Description
<chset>	string	IRA	character set to be used by the device.

Values:

- GSM : GSM default alphabet (3GPP TS 23.038).
- IRA : international reference alphabet (ITU-T T.50).
- 8859-1 : ISO 8859 Latin 1 character set.
- PCCP437 : PC character set Code Page 437.
- UCS2 : 16-bit universal multiple-octet coded character set (ISO/IEC10646).
- HEX : Character strings consist only of hexadecimal numbers from 00 to FF; e.g. "032FE6" equals three 8-bit characters with decimal values 3, 47 and 230; no conversions to the original MT character set shall be done. If MT is using GSM 7 bit default alphabet, its characters shall be padded with 8th bit (zero) before converting them to hexadecimal numbers (i.e. no SMS style packing of 7 bit alphabet).



AT+CSCS?

Read command returns the current value of the active character set.



AT+CSCS=?

Test command returns the supported values for parameter <chset>.

3.1.2.39. AT+CMUX - Multiplexing Mode

This command is used to enable/disable the multiplexing protocol control channel.



3GPP TS 27.007
3GPP TS 27.010

SIM Presence	Setting saved	Can be aborted	MAX timeout	SELINT
Not required	No	No	-	2



AT+CMUX=<mode>[,<subset>[,<port_speed>[,<N1>[,<T1>[,<N2>[,<T2>[,<T3>[,<k>]]]]]]]]]

Set command is used to enable/disable the multiplexing protocol control channel.

Parameters:

Name	Type	Default	Description
<mode>	integer	0	basic option is currently the only supported mode. Value: 0 : basic option mode.
<subset>	integer	0	the way in which the multiplexer control channel is set up Values: 0 : UIH frame 1 : UI frames used only 2 : I frames used only
<port_speed>	integer	N/A	transmission rate. The default value is implementation specific. Values: 1 : 9600 bps 2 : 19200 bps 3 : 38400 bps 4 : 57600 bps 5 : 115200 bps 6 : 230400 bps
<N1>	integer	31	maximum frame size. Value: 1÷32768 : expressed in bytes
<T1>	integer	10	acknowledgement timer in units of ten milliseconds Value: 1÷255 : in units of ten milliseconds
<N2>	integer	3	maximum number of re-transmissions

	Value:		
	0÷100	:	range of re-transmissions number
<T2>	integer	30	response timer for the multiplexer control channel. T2 must be longer than T1.
	Value:		
	2÷255	:	in units of ten milliseconds
<T3>	integer	10	wake up response timer
	Value:		
	1÷255	:	in seconds
<k>	integer	2	window size, for Advanced option with Error-Recovery Mode
	Value:		
	1÷7	:	window size range

**AT+CMUX?**

Read command returns the current value of the parameters, in the format:

+CMUX: <mode>,<subset>,<port_speed>,<N1>,<T1>,<N2>,<T2>,<T3>,<k>

**AT+CMUX=?**

Test command returns the range of supported values for all parameters.

3.1.2.40. AT#USBCFG - USB Configuration

This command sets USB configuration on the modem device.

SIM Presence	Setting saved	Can be aborted	MAX timeout	SELINT
Not required	Auto	No	-	2



AT#USBCFG=<mode>

Parameter:

Name	Type	Default	Description
<mode>	integer	0	USB configuration mode. See #PORTCFG command.

Values:

- 0 : USB Modem Ports, 1 Diag Port, 1 WWAN network adapter; VID 0x1BC7 PID 0x1101
- 3 : USB Modem Ports, 1 Diag Port, 1 ECM network adapter; VID 0x1BC7 PID 0x1102



To make active the configuration the module must be rebooted.



AT#USBCFG?

Read command returns the current <mode> in the following format:

#USBCFG: <mode>



AT#USBCFG=?

Test command returns the list of supported values.

3.1.2.41. AT#PORTCFG - Connect Physical Ports to Service Access Points

This command allows to connect Service Access Points (software anchorage points) to the external physical ports.



[1] Hardware User's Guide of the used module

SIM Presence	Setting saved	Can be aborted	MAX timeout	SELINT
Not required	Auto	No	-	2



AT#PORTCFG=<Variant>

Set command allows to connect Service Access Points to the external physical ports giving a great flexibility. Examples of Service Access Points: AT Parser Instance #1, #2, #3, etc..

Parameter:

Name	Type	Default	Description
<Variant>	integer	0	set port configuration. A short description, for each <Variant> value, is reported in test command section. The range depends on the product.

Value:

0-max : see test command section



To enable the set port configuration, the module must be rebooted.



AT#PORTCFG?

Read command returns the requested and the active port configuration in the format:

#PORTCFG: <requested>,<active>

Additional info:

▶▶ Parameters returned by the read command, in format:

#PORTCFG: <requested>,<active>

Name	Type	Default	Description
<requested>	integer	-	value showing the requested configuration that will be activated on the next power ON.
<active>	integer	-	value showing the actual configuration.



AT#PORTCFG=?

Test command returns a brief description of the supported ports arrangement solutions.

For each <Variant> are reported, on one row, the logical connections between a physical port (USIF0, USB0, etc.) and a Service Access Point (AT#1, AT#2, etc.). Each row reports the logical

connections available in two configurations: USB cable plugged or not plugged in. To have information about the physical ports, refer to document [1].

The test command returns, for example, the following message:

```
AT#PORTCFG=?  
#PORTCFG: Variant=0: AT= USIF0 USB0 USB1  
#PORTCFG: Variant=3: AT= USIF0 USIF1 USB0  
#PORTCFG: Variant=8: AT= USB0 USB1  
#PORTCFG: Variant=13: AT= USIF0 USB0; CMUX
```

OK

The **<Variant>** range depends on the product.

3.1.2.42. AT#ATDELAY - AT Command Delay

Set command sets a delay in second for the execution of successive AT command.

SIM Presence	Setting saved	Can be aborted	MAX timeout	SELINT
Not required	No	No	-	2



AT#ATDELAY=<delay>

Parameter:

Name	Type	Default	Description
<delay>	integer	0	delay interval

Value:

0÷max : delay expressed in 100 milliseconds intervals; 0 means no delay. For max value refer to test command



<delay> is only applied to first command executed after #ATDELAY



AT#ATDELAY=?

Test command returns the supported range of values for parameter <delay>.



Set 5 seconds delay for "AT#GPIO=1,1,1" command

```
AT#GPIO=1,0,1;#ATDELAY=50;#GPIO=1,1,1
OK
```

3.1.2.43. AT&Z - Store Telephone Number in the Internal Phonebook

The command stores a telephone number in the internal phonebook.

SIM Presence	Setting saved	Can be aborted	MAX timeout	SELINT
Not required	No	No	-	2





AT&Z<n>=<nr>

The module has a built in non-volatile memory where 10 telephone numbers can be stored, each one having a maximum of 24 digits. Execution command stores the telephone number <nr> in the record <n>. The records cannot be overwritten; they must be cleared before rewriting.

Parameters:

Name	Type	Default	Description
<n>	integer	N/A	phonebook record
Value:			
	0÷9	:	record number
<nr>	string	-	telephone number (maximum length 24 digits)

-  To delete the record <n> issue the command **AT&Z<n>=<CR>**.
-  The records in the module memory can be viewed with the command **&N**.

3.1.2.44. AT&V2 - Display Last Connection Statistics

The command displays last connection statistics.

SIM Presence	Setting saved	Can be aborted	MAX timeout	SELINT
Not required	No	No	-	2



AT&V2

Execution command returns the last connection statistics and connection failure reason.



Example of connection statistics get with no connection and no error.

- **AT&V2**

```
TOTAL CONNECTION TIME      : 0:00:00
CONNECTION FAILURE REASON  : powered off
```

```
OK
```

3.1.2.45. AT+IMEISV - Request IMEI and Software Version

Execution command returns the International Mobile Station Equipment Identity and Software Version Number (IMEISV) of the module without **+IMEISV:** command echo.



3GPP TS 23.003

SIM Presence	Setting saved	Can be aborted	MAX timeout	SELINT
Not required	No	No	-	2



AT+IMEISV

The command returns the following message:

```
AT+IMEISV
<IMEISV>
```

OK

Additional info:

- ▶▶ The IMEISV is composed of the following elements (each element shall consist of decimal digits only):
 - Type Allocation Code (TAC). Its length is 8 digits
 - Serial Number (SNR) is an individual serial number uniquely identifying each equipment within each TAC. Its length is 6 digits
 - Software Version Number (SVN) identifies the software version number of the mobile equipment. Its length is 2 digits



AT+IMEISV=?

Test command returns **OK** result code.

3.1.2.46. AT#CGMM - Request Model Identification

This command returns the device model identification.

SIM Presence	Setting saved	Can be aborted	MAX timeout	SELINT
Not required	No	No	-	2



AT#CGMM

Execution command returns the device model identification code, with command echo.

```
AT#CGMM
#CGMM: <code>
OK
```



AT#CGMM=?

Test command returns **OK** result code.

3.1.2.47. AT&V0 - Display Current Configuration and Profile



The command displays current modem configuration and profile.

SIM Presence	Setting saved	Can be aborted	MAX timeout	SELINT
Not required	No	No	-	2



AT&V0

Execution command returns all the modem configuration parameters settings.

-  This command is the same as **&V**, it is included only for backwards compatibility.
-  The row of information about CTS (C106) OPTIONS is in the output of **&V0** only for compatibility reasons and represents only a dummy value.

3.1.2.48. AT#FWSWITCH - Set Active Firmware Image

Set command allows enabling a specific firmware image on products embedding 2 or more different firmware images.

SIM Presence	Setting saved	Can be aborted	MAX timeout	SELINT
Not required	Auto	No	-	2



AT#FWSWITCH=<imageNumber>[,<storageConf>]

Parameters:

Name	Type	Default	Description
<imageNumber>	integer	-	To know the <imageNumber> values range refer to the test command. For the relation between <imageNumber> value and the relative customization refer to the table in Additional info section where is also described the default values.
<storageConf>	integer	1	selects storage type

Value:

1 : save the <imageNumber> value in NVM, only this selection is available

Additional info:

▶▶ <imageNumber> identifies the image (customization) as shown in the following table.

Product	Customization	<imageNumber> default value
ME910C1-NA	0 = AT&T, 1 = Verizon	0
ML865C1-NA	0 = AT&T, 1 = Verizon	0
ME910C1-WW	0 = AT&T, 1 = Verizon, 2 = Global	2
All other	no customization	0



This AT command performs a system reboot. All the parameters are set to the factory values.



AT#FWSWITCH?

Read command reports the current active firmware image:

#FWSWITCH: <imageNumber>

**AT#FWSWITCH=?**

Test command reports the range of supported values for parameters **<imageNumber>**, **<storageConf>**



Switch to image 1:
AT#FWSWITCH =1
OK

3.1.2.49. AT#TID - Request Telit ID

The command returns Telit ID and version number.

SIM Presence	Setting saved	Can be aborted	MAX timeout	SELINT
Not required	No	No	-	2



AT#TID

Execution command returns device Telit ID and version number separated by a comma, followed by an **OK** at newline.



AT#TID=?

Test command returns **OK** result code.

3.1.3. S Parameters

3.1.3.1. ATSO - Number of Rings to Auto Answer

The command controls the automatic answering feature of the DCE.



ITU-T Recommendation V.25 ter
3GPP TS 27.007

SIM Presence	Setting saved	Can be aborted	MAX timeout	SELINT
Not required	Specific profile	No	-	2



ATSO=[<n>]

Set command sets the number of rings required before device automatically answers an incoming call.

Parameter:

Name	Type	Default	Description
<n>	integer	0	Number of rings

Values:

- 0 : auto answer disabled
- 1÷255 : number of rings required before automatic answer. The DCE answers when the incoming call indication (ring) has occurred the number of times indicated by the value.



Data only products ignore command setting and auto answer is disabled if incoming call is a voice call.



ATSO?

Read command returns the current value of **S0** parameter.

3.1.3.2. AT^{S1} - Ring Counter

S1 is incremented each time the device detects the ring signal of an incoming call. **S1** is cleared as soon as no ring occur.

SIM Presence	Setting saved	Can be aborted	MAX timeout	SELINT
Not required	Specific profile	No	-	2



AT^{S1}

 The form **AT^{S1}** has no effect, returns **OK** result code.



AT^{S1}?

Read command returns **S1** value.

3.1.3.3. ATS2 - Escape Character

The command manages the ASCII character used as escape character.

SIM Presence	Setting saved	Can be aborted	MAX timeout	SELINT
Not required	Specific profile	No	-	2



ATS2=<char>

Set command sets the ASCII character to be used as escape character.

Parameter:

Name	Type	Default	Description
<char>	integer	43	escape character decimal ASCII

Value:

0=255 : factory default value is '+'

-  The escape sequence consists of three escape characters preceded and followed by **n** ms of idle (see **S12** to set **n**).



ATS2?

Read command returns the current value of **S2** parameter.

-  The format of the numbers in output is always 3 digits, left-filled with 0s.

3.1.3.4. AT S3 - Command Line Termination Character

The command manages the character configured as command line terminator.



ITU-T Recommendation V.25 ter
3GPP TS 27.007

SIM Presence	Setting saved	Can be aborted	MAX timeout	SELINT
Not required	Specific profile	No	-	2



AT S3=[<char>]

Set command sets the value of the character either recognized by the device as command line terminator and generated by the device as part of the header, trailer, and terminator for result codes and information text, along with **S4** parameter.

Parameter:

Name	Type	Default	Description
<char>	integer	13	command line termination character (decimal ASCII)

Value:

0÷127 : command line termination character

- i** The "previous" value of **S3** is used to determine the command line termination character for entering the command line containing the **S3** setting command. However, the result code issued shall use the "new" value of **S3** (as set during the processing of the command line)



AT S3?

Read command returns the current value of **S3** parameter.

- i** The format of the numbers in output is always 3 digits, left-filled with 0s

3.1.3.5. ATS4 - Response Formatting Character

The command manages the character generated by the device as part of the header, trailer, and terminator for result codes and information text.



ITU-T Recommendation V.25 ter
3GPP TS 27.007

SIM Presence	Setting saved	Can be aborted	MAX timeout	SELINT
Not required	Specific profile	No	-	2



ATS4=[<char>]

Set command sets the value of the character generated by the device as part of the header, trailer, and terminator for result codes and information text, along with the **S3** parameter.

Parameter:

Name	Type	Default	Description
<char>	integer	10	response formatting character (decimal ASCII)

Value:

0÷127 : response formatting character

- i** If the value of **S4** is changed in a command line the result code issued in response of that command line will use the new value of **S4**.



ATS4?

Read command returns the current value of **S4** parameter.

- i** The format of the numbers in output is always 3 digits, left-filled with 0s.

3.1.3.6. AT55 - Command Line Editing Character

The command manages the value of the character recognized by the DCE as a request to delete from the command line the immediately preceding character.



ITU-T Recommendation V.25 ter
3GPP TS 27.007

SIM Presence	Setting saved	Can be aborted	MAX timeout	SELINT
Not required	Specific profile	No	-	2



AT55=<char>

Set command sets the value of the character recognized by the device as a request to delete from the command line the immediately preceding character.

Parameter:

Name	Type	Default	Description
<char>	integer	8	command line editing character (decimal ASCII)

Value:

0÷127 : command line editing character



AT55?

Read command returns the current value of **S5** parameter.

- The format of the numbers in output is always 3 digits, left-filled with 0s.

3.1.3.7. AT S7 - Connection Completion Time-Out

This set command specifies the amount of time that the DCE shall allow between either answering a call (automatically or by the **ATA** command) or completion of signaling of call addressing information to network (dialing), and establishment of a connection with the remote DCE. If no connection is established during this time, the DCE disconnects from the line and returns a result code indicating the cause of the disconnection.



ITU-T Recommendation V.25 ter
3GPP TS 27.007

SIM Presence	Setting saved	Can be aborted	MAX timeout	SELINT
Not required	Specific profile	No	-	2



AT S7=<tout>

Parameter:

Name	Type	Default	Description
<tout>	integer	60	defines time interval expressed in seconds

Value:

1÷255 : available range



AT S7?

Read command returns the current value of **S7** parameter.

- The format of the numbers in output is always 3 digits, left-filled with 0s.

3.1.3.8. ATS12 - Escaper Prompt Delay

The command manages the prompt delay between two different escape characters.

SIM Presence	Setting saved	Can be aborted	MAX timeout	SELINT
Not required	Specific profile	No	-	2



ATS12=<time>

Set command sets:

- the minimum period, before receipt of the first character of the three escape character sequence, during which no other character has to be detected in order to accept it as valid first character;
- the maximum period allowed between receipt of first or second character of the three escape character sequence and receipt of the next;
- the minimum period, after receipt of the last character of the three escape character sequence, during which no other character has to be detected in order to accept the escape sequence as a valid one.

Parameter:

Name	Type	Default	Description
<time>	integer	50	delay expressed in fiftieth of a second

Value:

2÷255 : expressed in fiftieth of a second

- The minimum period **S12** has to pass after **CONNECT** result code too, before a received character is accepted as valid first character of the three escape character sequence.



ATS12?

Read command returns the current value of **S12** parameter.

- The format of the numbers in output is always 3 digits, left-filled with 0s

3.1.3.9. ATS25 - Delay to DTR Off

The command manages the amount of time that the device will ignore the **DTR**.

SIM Presence	Setting saved	Can be aborted	MAX timeout	SELINT
Not required	Specific profile	No	-	2



ATS25=<time>

Set command defines the amount of time, in hundredths of second, that the device will ignore the **DTR** for taking the action specified by command **&D**.

Parameter:

Name	Type	Default	Description
<time>	integer	5	expressed in hundredths of a second

Value:

0-255 : expressed in hundredths of a second

- i** The delay is effective only if its value is greater than 5. To be recognized as valid, the **DTR** transition must be greater than **S25**. Low values could require a transition increased of a factor 1.5 to be correctly handled (e.g., to be sure that **S25=5** works, use a **DTR** toggle of 75ms to be detected).
- i** In power saving (e.g. **+CFUN=5** with **DTR** low) **DTR** must be off at least 3 seconds for taking the action specified by command **&D**, independently of **S25** parameter.



ATS25?

Read command returns the current value of **S25** parameter.

- i** The format of the numbers in output is always 3 digits, left-filled with 0s.

3.1.3.10. AT&V1 - S Registers Display

The command displays the S registers values.

SIM Presence	Setting saved	Can be aborted	MAX timeout	SELINT
Not required	No	No	-	2



AT&V1

Execution command returns the S registers values in both decimal and hexadecimal format. The response is in the form:

REG (S register)	DEC (value in dec. notation)	HEX (value in hex notation)
<reg0>	<dec>	<hex>
<reg1>	<dec>	<hex>
...
<regN>	<dec>	<hex>



Here is a generic example showing the format.

AT&V1

```

REG DEC HEX
000 000 000
001 000 000
002 043 02B
003 013 00D
004 010 00A
005 008 008
007 060 03C
012 050 032
... ..
... ..
OK

```

3.1.3.11. ATs10 - Carrier Off with Firm Time

The command is available only for backward compatibility

SIM Presence	Setting saved	Can be aborted	MAX timeout	SELINT
Not required	Specific profile	No	-	2



ATs10=<n>

Execution command has no effect and is available only for backward compatibility with landline modems.

Parameter:

Name	Type	Default	Description
<n>	integer	N/A	dummy

Value:

1÷255 : dummy parameter

3.1.3.12. AT&V3 - Extended S Registers Display

The command displays the extended S registers values.

SIM Presence	Setting saved	Can be aborted	MAX timeout	SELINT
Not required	No	No	-	2



AT&V3

Execution command returns the extended S registers values in both decimal and hexadecimal format. The response is in the form as shown in **AT&V1** command.



Here is a generic example showing the format.

AT&V3

```

REG  DEC  HEX
000  000  000
001  000  000
002  043  02B
003  013  00D
004  010  00A
005  008  008
007  060  03C
012  050  032
025  005  005
...   ...  ...
...   ...  ...

OK

```

3.1.4. DTE - Modem Interface Control

3.1.4.1. ATE - Command Echo

This command allows to enable or disable the command echo.



ITU-T Recommendation V.25 ter

SIM Presence	Setting saved	Can be aborted	MAX timeout	SELINT
Not required	Specific profile	No	-	2



ATE[<n>]

The execution command allows to enable/disable the command echo.

Parameter:

Name	Type	Default	Description
<n>	integer	1	Configuration value

Values:

- 0 : disables command echo
- 1 : enables command echo, hence command sent to the device are echoed back to the DTE before the response is given.

i If parameter is omitted, the command has the same behavior of **ATE0**

3.1.4.2. ATQ - Quiet Result Codes

This command allows to enable or disable the result code.



ITU-T Recommendation V.25 ter

SIM Presence	Setting saved	Can be aborted	MAX timeout	SELINT
Not required	Specific profile	No	-	2



ATQ[<n>]

Set command enables or disables the result codes.

Parameter:

Name	Type	Default	Description
<n>	integer	0	enables/disables result codes

Values:

- 0 : enables result codes
- 1 : disables result codes. The commands entered after ATQ1 do not return the result code.
- 2 : disables result codes (only for backward compatibility). The commands entered after ATQ2 do not return the result code.



If parameter is omitted, the command has the same behavior of **ATQ0**.



After issuing **ATQ0** the **OK** result code is returned
AT+CGACT=?
+CGACT: (0-1)
OK

After issuing **ATQ1** or **ATQ2** the **OK** result code is not returned.
AT+CGACT=?
+CGACT: (0-1)

3.1.4.3. ATV - Response Format

Set command determines the contents of the header and trailer transmitted with result codes and information responses. It also determines if result codes are transmitted in a numeric form or an alphanumeric form (according to [1]).



[1] ITU-T Recommendation V.25 ter

SIM Presence	Setting saved	Can be aborted	MAX timeout	SELINT
Not required	Specific profile	No	-	2



ATV[<n>]

Parameter:

Name	Type	Default	Description
<n>	integer	1	format of information responses and result codes. See Additional info section.

Values:

- 0 : limited headers and trailers and numeric format of result codes
- 1 : full headers and trailers and verbose format of result codes

Additional info:

<n>=0	
information responses	<text><CR><LF>
result codes	<numericCode><CR>
<n>=1	
information responses	<CR><LF> <text><CR><LF>
result codes	<CR><LF> <verboseCode><CR><LF>

- i** the <text> portion of information responses is not affected by this setting.
- i** if parameter is omitted, the command has the same behavior of **ATV0**

3.1.4.4. ATI - Identification Information

This command returns identification information.



ITU-T Recommendation V.25 ter

SIM Presence	Setting saved	Can be aborted	MAX timeout	SELINT
Not required	No	No	-	2



ATI[<n>]

Execution command returns one or more lines of information text followed by a result code.

Parameter:

Name	Type	Default	Description
<n>	integer	0	information request

Values:

- 0 : numerical identifier
- 1 : module checksum
- 2 : checksum check result
- 3 : manufacturer
- 4 : product name
- 5 : DOB version



If parameter is omitted, the command has the same behavior of **ATI0**

3.1.4.5. AT&C - Data Carrier Detect (DCD) Control

This set command controls the DCD output behavior of the AT commands serial port.



ITU-T Recommendation V25 ter

SIM Presence	Setting saved	Can be aborted	MAX timeout	SELINT
Not required	No	No	-	2



AT&C[<n>]

Parameter:

Name	Type	Default	Description
<n>	integer	1	DCD output behavior

Values:

- 0 : DCD remains always High
- 1 : DCD follows the Carrier detect status: if carrier is detected DCD goes High, otherwise DCD is Low
- 2 : DCD is always High except for 1 sec "wink" when a data call is disconnected



If parameter is omitted, the command has the same behavior of **AT&C0**

3.1.4.6. AT&D - Data Terminal Ready (DTR) Control

This set command configures the behavior of the module according to the DTR control line transitions (RS232).

SIM Presence	Setting saved	Can be aborted	MAX timeout	SELINT
Not required	Specific profile	No	-	2



AT&D[<n>]

Parameter:

Name	Type	Default	Description
<n>	integer	0	defines the module behavior according to the DTR control line transitions

Values:

- 0 : module ignores DTR control line transitions
- 1 : when the module is connected, the high to low transition of DTR line sets the module in command mode, the current connection is not closed
- 2 : when the module is connected, the high to low transition of DTR line sets the module in command mode and the current connection is closed
- 3 : C108/1 operation is enabled
- 4 : C108/1 operation is disabled

- i** If **AT&D2** has been issued, and the DTR line has been tied Low, auto-answering is inhibited and it is possible to answer only issuing command **ATA**.
- i** If parameter is omitted, the command has the same behavior of **AT&D0**.

3.1.4.7. AT&K - Flow Control

Flow Control settings.

SIM Presence	Setting saved	Can be aborted	MAX timeout	SELINT
Not required	Specific profile	No	-	2



AT&K[<n>]

Set command controls the serial port flow control behavior.

Parameter:

Name	Type	Default	Description
<n>	integer	3	flow control behavior

Values:

- 0 : no flow control
- 3 : hardware bi-directional flow control (both RTS/CTS active)

- i** If parameter is omitted, the command has the same behavior as **AT&K0**
- i** **&K** has no Read Command. To verify the current setting of **&K**, simply check the settings of the active profile issuing **AT&V**.

3.1.4.8. AT&S - Data Set Ready (DSR) Control

Set DSR pin behavior.

SIM Presence	Setting saved	Can be aborted	MAX timeout	SELINT
Not required	Specific profile	No	-	2



AT&S[<n>]



Set command controls the RS232 DSR pin behavior.

Parameter:

Name	Type	Default	Description
<n>	integer	3	Configuration parameter

Values:

- 0 : always High
- 1 : DSR is tied High when the device receives from the network the GSM traffic channel indication
- 2 : High when connected
- 3 : High when device is ready to receive commands

-  If parameter is omitted, the command has the same behavior of **AT&S0**
-  In power saving mode the **DSR** pin is always tied Low.

3.1.4.9. AT+IPR - UART DCE Interface Data Rate Speed

The command sets the speed of the USIF0 serial port, see document [1].



- [1] Hardware User's Guide of the used module
[2] ITU-T Recommendation V25 ter

SIM Presence	Setting saved	Can be aborted	MAX timeout	SELINT
Not required	Specific profile	No	-	2



AT+IPR=<rate>

The command sets the UART speed of the USIF0 port during command mode operations.

Parameter:

Name	Type	Default	Description
<rate>	integer	115200	speed of the serial USIF0 port expressed in bit per second.

Values:

300	: bps
600	: bps
1200	: bps
2400	: bps
4800	: bps
9600	: bps
19200	: bps
38400	: bps
57600	: bps
115200	: bps
230400	: bps
460800	: bps
921600	: bps
2900000	: bps
3200000	: bps
3686400	: bps
4000000	: bps



AT+IPR?

Read command returns the current value of <rate> parameter.



AT+IPR=?

Test command returns the list of <rate> values in the format:

+IPR: (list of <rate> values)



This command has no effect if it is sent on **USB** interface or **CMUX** instances: the DCE sends the **OK** result but the settings are ignored.

 Test command example

```
AT+IPR=?  
+IPR:  
(300,600,1200,2400,4800,9600,19200,38400,57600,115200,230400,460800,921600,2900000,3200000,  
3686400,4000000)  
OK
```

3.1.4.10. AT+IFC - DTE-Modem Local Flow Control

This set command selects the flow control of the serial port in both directions.



ITU-T Recommendation V25 ter

SIM Presence	Setting saved	Can be aborted	MAX timeout	SELINT
Not required	Specific profile	No	-	2



AT+IFC=<byDTE>,<byDCE>

Parameters:

Name	Type	Default	Description
<byDTE>	integer	2	specifies the method used by the DTE to control the flow of data received from the device (DCE)

Values:

- 0 : no flow control
- 2 : flow control by RTS control line (C105, Request to Send)

<byDCE>	integer	2	specifies the method used by the device (DCE) to control the flow of data received from the DTE
---------	---------	---	---

Values:

- 0 : no flow control
- 2 : flow control by CTS control line (C105, Clear to Send)

i The only possible commands are **AT+IFC=0,0** and **AT+IFC=2,2**.



AT+IFC?

Read command returns active flow control settings.



AT+IFC=?

Test command returns all supported values of the parameters <byDTE> and <byDCE>.

3.1.4.11. AT+ICF - DTE-Modem Character Framing

This set command defines the asynchronous character framing.



ITU-T Recommendation V.25 ter

SIM Presence	Setting saved	Can be aborted	MAX timeout	SELINT
Not required	Specific profile	No	-	2



AT+ICF=<format>[,<parity>]

Parameters:

Name	Type	Default	Description
<format>	string	3	sets the number of Data bits and Stop bits. Only the <format>=3 is supported.
Value:			
3 : 8 Data, 1 Stop			
<parity>	string	0	setting this sub parameter has no meaning.
Values:			
0 : odd, not supported			
1 : even, not supported			



AT+ICF?

Read command returns current settings for parameters **<format>** and **<parity>**. The setting of parameter **<parity>** is always 0.



AT+ICF=?

Test command returns the ranges of values for the parameters **<format>** and **<parity>**.



```
AT+ICF=3
OK
```

```
AT+ICF=?
+ICF: (3),(0,1)
OK
```

3.1.4.12. AT#SKIPESC - Skip Escape Sequence

This command enables/disables skipping the escape sequence.

SIM Presence	Setting saved	Can be aborted	MAX timeout	SELINT
Required	Specific profile	No	-	2



AT#SKIPESC=[<mode>]

Set command enables/disables skipping the escape sequence (+++) while transmitting during a data connection.

Parameter:

Name	Type	Default	Description
<mode>	integer	0	enable/disable skipping the escape sequence (+++)

Values:

- 0 : does not skip the escape sequence; its transmission is enabled.
- 1 : skips the escape sequence; its transmission is not enabled.



In FTP connection the escape sequence is not transmitted, regardless of the command setting.



AT#SKIPESC?

Read command returns the current value of the parameter <mode> in the format:

#SKIPESC: <mode>



AT#SKIPESC=?

Test command returns the supported values of parameter <mode>.

3.1.4.13. AT#E2ESC - Escape Sequence Guard Time

This set command sets a guard time in seconds for the escape sequence in PS to be considered a valid one, and return to on-line command mode.

SIM Presence	Setting saved	Can be aborted	MAX timeout	SELINT
Required	Auto	No	-	2



AT#E2ESC=[<gt;]

Parameter:

Name	Type	Default	Description
<gt;	string	0	sets a guard time in seconds

Values:

- 0 : guard time is defined by S12 command
- 1÷10 : guard time in seconds. It overrides the one set with S12 command



AT#E2ESC?

Read command returns current value of the escape sequence guard time, in the format:

#E2ESC: <gt;



AT#E2ESC=?

Test command returns the range of supported values for parameter <gt;.

3.1.4.14. ATX - Extended Result Codes

Set command selects the subset of result code messages the modem uses to reply to the DTE upon AT commands execution.



ITU-T Recommendation V.25 ter

SIM Presence	Setting saved	Can be aborted	MAX timeout	SELINT
Required	Specific profile	No	-	2



ATX[<n>]

Parameter:

Name	Type	Default	Description
<n>	integer	1	configuration value

Values:

- 0 : when entering in dial mode a **CONNECT** result code is relayed; see Additional info.
- 1÷4 : when entering in dial mode a **CONNECT <text>** result code is relayed, see Additional info.

Additional info:

- ▶▶ <n>=0
OK, CONNECT, RING, NO CARRIER, ERROR, NO ANSWER result codes are enabled.
Dial tone and busy detection (**NO DIALTONE** and **BUSY** result codes) are disabled.

<n>=1÷4
all the remaining result codes are enabled.

- ❗ When the <n> parameter is omitted, the command acts like **ATX0**.

3.1.5. Call (Voice and Data) Control

3.1.5.1. ATD - Dialup Connection

This command establishes a GPRS communication between the TE and the external PDN.



3GPP TS 27.007

SIM Presence	Setting saved	Can be aborted	MAX timeout	SELINT
Required	No	Yes	-	2



ATD

The **ATD** execution command, used for GPRS functionality, assumes the format shown in Additional info section. It causes the MT to perform whatever actions are necessary to establish communication between the TE and the external PDN.

Additional info:

▶▶ **ATD**<gprs_sc>*[**<addr>*][**<L2P>*][**<cid>*]]#**

Name	Type	Default	Description
<i><gprs_sc></i>	integer	N/A	is the GPRS Service Code, which identifies a request to use the GPRS communication
Value:			
	99	:	GPRS Service Code
<i><addr></i>	string	-	identifies the called party in the address space applicable to the PDP.
<i><L2P></i>	string	-	indicates the layer 2 protocol to be used (see +CGDATA). For communications software that does not support arbitrary characters in the dial string, the following numeric equivalents shall be used: 1 is equivalent to PPP.
<i><cid></i>	integer	-	PDP context definition, see +CGDCONT command

3.1.5.2. ATH - Hang Up/Disconnect the Current Call

This execution command hangs up/disconnects the current voice/data call or dial-up.



ITU-T Recommendation V.25 ter

SIM Presence	Setting saved	Can be aborted	MAX timeout	SELINT
Not required	No	No	-	2



ATH



When a data call or a dial-up is active the device is in on-line mode hence, to execute **ATH** command the device must be previously turned in command mode using the escape sequence or, if **&D1** option is active, tying Low the DTR pin.

3.1.5.3. ATO - Return to ON-Line Mode

This execution command is used, during a suspended data conversation, to return in on-line mode from command mode. If there is no suspended conversation, it returns **NO CARRIER**.



ITU-T Recommendation V. 25 ter

SIM Presence	Setting saved	Can be aborted	MAX timeout	SELINT
Not required	No	No	-	2



ATO



After issuing **ATO** command, the device returns in on-line mode. To enter again command-mode you must issue the escape sequence, see register **S2**.

3.1.6. Modulation & Compression Control

3.1.6.1. AT%E - Line Quality and Auto Retrain

This command is used for line quality monitoring and auto retrain or fall back/fall forward.

SIM Presence	Setting saved	Can be aborted	MAX timeout	SELINT
Not required	No	No	-	2



AT%E[<n>]

Execution command has no effect and is included only for backward compatibility with landline modems.

Parameter:

Name	Type	Default	Description
<n>	integer	-	this parameter is not really used, and it is present only for backward compatibility

-  If <n> parameter is not specified, the default value is considered

3.2. Network

3.2.1. AT+CNUM - Subscriber Number

Execution command returns the MSISDN (if the phone number of the device has been stored in the SIM card)



3GPP TS 27.007

SIM Presence	Setting saved	Can be aborted	MAX timeout	SELINT
Required	No	No	-	2



AT+CNUM

Execution command returns the MSISDN (if the phone number of the device has been stored in the SIM card) using the following format:

+CNUM: <alpha>,<number>,<type>[<CR><LF>

+CNUM: <alpha>,<number>,<type>[...]

The parameters are described in the Additional info section.

Additional info:

- ▶▶ List of the parameters meaning.

Name	Type	Default	Description
<alpha>	string	-	alphanumeric string associated to <number>; the character set depends on the value set with +CSCS .
<number>	string	-	numeric string containing the phone number in the format <type>.
<type>	integer	N/A	type of number.

Values:

129 : national numbering scheme

145 : international numbering scheme (contains the character "+")



AT+CNUM=?

Test command returns the **OK** result code.

3.2.2. AT+COPN - Read Operator Names

This command read operator names.



3GPP TS 27.007

SIM Presence	Setting saved	Can be aborted	MAX timeout	SELINT
Required	Auto	No	-	2



AT+COPN

Execution command returns the list of operator names from the ME in the format:

+COPN: <numeric1>,<alpha1>[<CR>

+COPN: <numeric2>,<alpha2>[...]]

The parameters are described in the Additional info section.

Additional info:

- ▶▶ List of the parameters meaning.

Name	Type	Default	Description
<numeric>	string	-	operator in numeric format, see +COPS .
<alphan>	string	-	operator in long alphanumeric format, see +COPS .

- i** Each operator code <numeric> that has an alphanumeric equivalent <alphan> in the ME memory is returned.



AT+COPN=?

Test command returns the **OK** result code.

3.2.3. AT+CREG - Network Registration Status

The command enables/disables the network registration unsolicited result code (URC) and selects its presentation format.



3GPP TS 27.007

SIM Presence	Setting saved	Can be aborted	MAX timeout	SELINT
Not required	Specific profile	No	-	2



AT+CREG=[<mode>]

Set command enables/disables the network registration unsolicited result code and selects one of the two available formats:

short format: **+CREG: <stat>**

long format: **+CREG: <stat>[,<lac>,<ci>[,<AcT>]]**

The parameter meanings are shown in Unsolicited code value section.

Parameter:

Name	Type	Default	Description
<mode>	integer	0	enables/disables the network registration unsolicited result code and selects one of the two formats: short or long format. <ul style="list-style-type: none"> • URC short format is displayed every time there is a change in the network registration status • URC long format is displayed every time there is a change of the network cell

Values:

- 0 : disable the network registration unsolicited result code
- 1 : enable the network registration unsolicited result code, and selects the short format
- 2 : enable the network registration unsolicited result code, and selects the long format (includes the network cell identification data)

Unsolicited fields:

Name	Type	Description
<stat>	integer	network registration status of the module

Values:

- 0 : not registered, terminal is not currently searching a new operator to register to
- 1 : registered, home network
- 2 : not registered, but terminal is currently searching a new operator to register to
- 3 : registration denied
- 4 : unknown
- 5 : registered, roaming

<lac>	string	the parameter reports: <ul style="list-style-type: none"> Local Area Code when <AcT>=0 Tracking Area Code when <AcT>=8 or 9 									
<ci>	string	Cell Id for the currently registered on cell									
<AcT>	integer	access technology of the registered network Values: <table border="0"> <tr> <td>0</td> <td>:</td> <td>GSM</td> </tr> <tr> <td>8</td> <td>:</td> <td>CAT M1</td> </tr> <tr> <td>9</td> <td>:</td> <td>NB IoT</td> </tr> </table>	0	:	GSM	8	:	CAT M1	9	:	NB IoT
0	:	GSM									
8	:	CAT M1									
9	:	NB IoT									

i **<lac>**, **<ci>** and **<AcT>** network information is reported by URC only if **<mode>**=2, and the module is registered on some network cell.



AT+CREG?

Read command returns the current value of **<mode>**, the registration status **<stat>**, and the network information (**<lac>**, **<ci>** and **<AcT>**) according to the used **<mode>** parameter value.

+CREG: <mode>,<stat>[,<lac>,<ci>[,<AcT>]]

<lac>, **<ci>**, and **<AcT>** network information is reported only if **<mode>**=2 and the module is registered on some network cell.



AT+CREG=?

Test command returns supported values for parameter **<mode>**.



Check the registration status of the module.

AT+CREG?

+CREG: 0,2

OK

The module is in network searching state

...

...

Check again module status

AT+CREG?

+CREG: 0,1

OK

The module is registered

3.2.4. AT+COPS - Operator Selection

The command selects a network operator and registers the module.



3GPP TS 27.007

SIM Presence	Setting saved	Can be aborted	MAX timeout	SELINT
Required	Auto	No	-	2



AT+COPS=[<mode>,<format>,<oper>,<act>]]]

The set command attempts to select a network operator and registers the module on the just chosen operator; the selection can be automatic or manual.

Parameters:

Name	Type	Default	Description
<mode>	integer	0	defines the operator selection: automatic or manual.
Values:			
0	:	automatic selection, the parameter <oper> is ignored	
1	:	manual selection, the parameter <oper> must be present	
2	:	deregister from network. The module is unregistered until a +COPS with <mode>=0, 1 or 4 is issued	
3	:	set only <format> parameter, the parameter <oper> is ignored	
4	:	manual/automatic, <oper> parameter must be present. If manual selection fails, the module will tray automatic mode (<mode>=0)	
<format>	integer	0	specifies the operator name format, see <oper> parameter
Values:			
0	:	alphanumeric long form (max length 16 digits)	
1	:	alphanumeric short form	
2	:	numeric 5 or 6 digits [country code (3) + network code (2 or 3)]	
<oper>	mixed	-	network operator in format defined by <format> parameter
<act>	integer	N/A	selects access technology.
Values:			
0	:	GSM	
8	:	CAT M1	
9	:	NB IoT	

i <mode> parameter setting is stored in NVM and available at next reboot. <mode>=3 is not saved.

If <mode>=1 or 4, the selected network is stored in NVM too and is available at next reboot (this will happen also after inserting another SIM).

- <format>** parameter setting is never stored in NVM.
- If **AT+COPS=0** is issued after the switch-on, it causes a new attempt to select a network operator and registers the module on the selected operator.



AT+COPS?

Read command returns current value of **<mode>**, **<format>**, **<oper>** and **<AcT>** in format **<format>**. If no operator is selected, **<format>**, **<oper>** and **<AcT>** are omitted.

+COPS: <mode>[, <format>, <oper>,< act>]

If the module is deregistered, **<format>**, **<oper>**, and **<act>** parameters are omitted.



AT+COPS=?

Test command returns a list of quadruplets, each representing an operator present in the network. The quadruplets list is ended with the range values of the **<mode>** and **<formats>** parameters.

The quadruplets in the list are closed between round brackets, separated by commas, the **<oper>** parameter is returned in both formats.

+COPS: [quadruplets list (<stat>,<oper (in <format>=0)>,,<oper (in <format>=2)>,< act>), (<stat>,<oper (in <format>=0)>,,<oper (in <format>=2)>,< act>), ...] [, (range of <mode>), (range of <format>)]

<stat> parameter is described in the Additional info section.

Additional info:

- ▶▶ Meaning of the **<stat>** parameter.

Name	Type	Default	Description
<stat>	integer	N/A	operator availability

Values:

- 0 : unknown
- 1 : available
- 2 : current
- 3 : forbidden

- Since with this command a network scan is done, this command may require some seconds before the output is given.

3.2.5. AT+CLCK - Facility Lock/Unlock

This command is used to lock or unlock a **ME** on a network facility.



3GPP TS 27.007

SIM Presence	Setting saved	Can be aborted	MAX timeout	SELINT
Not required	No	No	-	2



AT+CLCK=<fac>,<mode>[,<password>[,<class>]]

Set command is used to lock, unlock or interrogate a modem or a network lock facility. Password is normally needed to do such actions

Parameters:

Name	Type	Default	Description
<fac>	string	N/A	facility to lock, unlock or interrogate
Values:			
"SC"	:	SIM (PIN request) (device asks SIM password at power-up and when this lock command issued)	
"FD"	:	SIM fixed dialing memory feature (if PIN2 authentication has not been done as during the current session, PIN2 is required as <passwd>)	
<mode>	integer	N/A	defines the operation to be done on the facility
Values:			
0	:	unlock facility	
1	:	lock facility	
2	:	query status	
<password>	string	-	shall be the same as password specified for the facility from the DTE user interface or with command Change Password +CPWD
<class>	integer	N/A	is a sum of integers, each representing an information class of which the command refers to; default is 7 (voice + data + fax).
Values:			
1	:	voice (telephony)	
2	:	data (refers to all bearer services)	
4	:	fax (facsimile services) (not supported by LTE)	
8	:	short message service	
16	:	data circuit sync	
32	:	data circuit async	
64	:	dedicated packet access	
128	:	dedicated PAD access	

Additional info:

▶▶ When **<mode>=2** and command is successful, it returns:

+CLCK: <status>

Name	Type	Default	Description
<status>	integer	N/A	the current status of the facility

Values:

0 : not active

1 : active



AT+CLCK=?

Test command reports all the facilities supported by the device.

3.2.6. AT+CPWD - Change Facility Password

This command changes the password for the facility lock function defined by command Facility Lock **+CLCK** command.



3GPP TS 27.007

SIM Presence	Setting saved	Can be aborted	MAX timeout	SELINT
Required	Other	Yes	-	2



AT+CPWD=<fac>,<oldpwd>,<newpwd>

Execution command changes the password for the facility lock function defined by command Facility Lock **+CLCK** command.

Parameters:

Name	Type	Default	Description
<fac>	string	N/A	facility lock function.
Values:			
"SC"	:	SIM (PIN request)	
"P2"	:	SIM PIN2	
<oldpwd>	string	-	it shall be the same as password specified for the facility from the ME user interface or with command +CPWD .
<newpwd>	string	-	new password.

i Parameter **<oldpwd>** is the old password while **<newpwd>** is the new one.



AT+CPWD=?

Test command returns a list of pairs (<fac>,<pwdlength>) which represents the available facilities and the maximum length of their password (<pwdlength>).

3.2.7. AT+CUSD - Unstructured Supplementary Service Data

Set command allows control of the Unstructured Supplementary Service Data (USSD 3GPP TS 22.090).



3GPP TS 27.007
 3GPP TS 22.090
 3GPP TS 23.038

SIM Presence	Setting saved	Can be aborted	MAX timeout	SELINT
Required	Specific profile	No	-	2



AT+CUSD=[<n>[,<str>[,<dc>]]]

The unsolicited result code enabled by parameter <n> is in the format:

+CUSD: <m>[,<str>,<dc>]

Parameters:

Name	Type	Default	Description
<n>	integer	0	disable/enable the presentation of an unsolicited result code
Values:			
0	:	disable the result code presentation	
1	:	enable the result code presentation	
2	:	cancel an ongoing USSD session (not applicable to read command response)	
<str>	string	-	USSD-string (when <str> parameter is not given, network is not interrogated)
<ul style="list-style-type: none"> If <dc> indicates that GSM338 default alphabet is used ME/TA converts GSM alphabet into current TE character set (see +CSCS). If <dc> indicates that 8-bit data coding scheme is used: ME/TA converts each 8-bit octet into two IRA character long hexadecimal number; e.g. octet with integer value 42 is presented to TE as two characters 2A (IRA 50 and 65). 			
<dc>	integer	-	3GPP TS 23.038 Cell Broadcast Data Coding Scheme in integer format (default is 0).

Unsolicited field:

Name	Type	Description
<m>	integer	Status service value
Values:		
0	:	no further user action required (network initiated USSD-Notify, or no further information needed after mobile initiated operation)

-
- | | | |
|---|---|---|
| 1 | : | further user action required (network initiated USSD-Request, or further information needed after mobile initiated operation) |
| 2 | : | USSD terminated by the network |
| 3 | : | other local client has responded |
| 4 | : | operation not supported |
| 5 | : | network time out |
-

**AT+CUSD?**

Read command reports the current value of the parameter <n>

**AT+CUSD=?**

Test command reports the supported values for the parameter <n>

3.2.8. AT+CPOL - Preferred Operator List

The command is used to edit or update the UICC preferred list of networks. The list is read in the UICC file selected by the command **+CPLS**.



3GPP TS 27.007

SIM Presence	Setting saved	Can be aborted	MAX timeout	SELINT
Required	No	No	-	2



AT+CPOL=[<index>] [,<format>[,<oper>[,<GSM_Act>,<GSM_Compact_Act>,<UTRAN_Act>,<E_UTRAN_ActN>]]]



Execution command writes an entry in the UICC list of preferred operators.

Parameters:

Name	Type	Default	Description
<index>	integer	N/A	the order number of operator in the UICC preferred operator list.
Value:			
1÷n : order number in the list			
<format>	integer	2	format for <oper> parameter.
Value:			
2 : numeric. Only 2 is allowed up to now			
<oper>	string	-	Operator Identifier.
<GSM_Act>	integer	N/A	GSM access technology.
Values:			
0 : access technology not selected			
1 : access technology selected			
<GSM_Compact_Act>	integer	N/A	GSM compact access technology. Currently the parameter is not supported but set value is accepted.
Values:			
0 : access technology not selected			
1 : access technology selected			
<UTRAN_Act>	integer	N/A	UTRAN access technology. Currently the parameter is not supported but set value is accepted.
Values:			
0 : access technology not selected			
1 : access technology selected			
<E_UTRAN_ActN>	integer	N/A	E-UTRAN access technology

Values:

0 : access technology not selected
1 : access technology selected

-  If **<index>** is used, and **<oper>** is not entered, the entry is deleted from the list of preferred operators.
-  If **<oper>** is used, and **<index>** is not used, **<oper>** is put in the next free location.
-  If only **<format>** is entered, the format of the **<oper>** in the read command is changed.



AT+CPOL?

Read command returns all used entries from the UICC list of preferred operators.



AT+CPOL=?

Test command returns the **<index>** range supported by the UICC and the range for the **<format>** parameter.



Entry 3 in the preferred list of the operators is deleted.

```
AT+CPOL=3
OK
```

Operator identifier 22603 is inserted in the next free location of the list.

```
AT+CPOL=,2,22603
OK
```

Format of **<oper>** in the read command is changed (only 2 is allowed up to now).

```
AT+CPOL=,2
OK
```

Operator Identifier 22603 is inserted in the 4th position of the list.

```
AT+CPOL=4,2,22603
OK
```

Available range for **<index>** is 1 to 20, for **<format>= 2**.

```
AT+CPOL=?
+CPOL: (1-20),(2)
```

3.2.9. AT+CPLS - Selection of Preferred PLMN List

The command is used to select a list of preferred PLMNs in the SIM/USIM card.



3GPP TS 27.007

SIM Presence	Setting saved	Can be aborted	MAX timeout	SELINT
Required	Auto	No	-	2



AT+CPLS=<list>

Set command select one PLMN selector with Access Technology list in the SIM card or active application in the UICC (GSM or USIM), that is used by **+CPOL** command.

Parameter:

Name	Type	Default	Description
<list>	integer	0	PLMNs list selector

Values:

- 0 : User controlled PLMN selector with Access Technology EFPLMNwAcT, if not found in the SIM/UICC then PLMN preferred list EFPLMNsel (this file is only available in SIM card or GSM application selected in UICC)
- 1 : Operator controlled PLMN selector with Access Technology EFOPLMNwAcT
- 2 : HPLMN selector with Access Technology EFHPLMNwAcT



The value set by command is directly stored in NVM and doesn't depend on the specific CMUX instance.



AT+CPLS?

Read command returns the selected PLMN selector **<list>** from the SIM/USIM.



AT+CPLS=?

Test command returns the whole index range supported **<list>s** by the SIM/USIM.

3.2.10. AT+CSQ - Signal Quality

Execution command returns received signal strength indication **<rssi>** and channel bit error rate **<ber>** from the MT.



- [1] 3GPP TS 27.007
- [2] 3GPP TS 07.07
- [3] 3GPP TS 25.133

SIM Presence	Setting saved	Can be aborted	MAX timeout	SELINT
Required	No	No	-	2



AT+CSQ

See Additional info sections.

Additional info:

▶▶ 2G Networks

The execution command returns the following message:

+CSQ: <rssi>,<ber>

Name	Type	Default	Description
<rssi>	integer	N/A	measurements of the radio signal power, expressed in dBm, are mapped to <rssi> as shown below
Values:			
0	:	-113 dBm or less	
1	:	-111 dBm	
2÷30	:	-109 dBm ... -53 dBm; 2 dBm per step	
31	:	-51 dBm or greater	
99	:	not known or not detectable	
<ber>	integer	N/A	measurements of the channel bit error rate, expressed in %, are mapped to <ber> as shown below
Values:			
0	:	less than 0.2%	
1	:	0.2% to 0.4%	
2	:	0.4% to 0.8%	
3	:	0.8% to 1.6%	
4	:	1.6% to 3.2%	
5	:	3.2% to 6.4%	
6	:	6.4% to 12.8%	
7	:	more than 12.8%	
99	:	not known or not detectable	

►► 4G Networks

The execution command returns the following message:

+CSQ: <rss>,<rsrq>

Name	Type	Default	Description
<rss>	integer	N/A	Received Signal Strength Indication. For <rss> to be compliant with 3GPP TS27.007 specification, levels are mapped to range 0...31.
Values:			
0	:	-113 dBm or less	
1	:	-111 dBm	
2÷30	:	-109...-53 dBm	
31	:	- 51 dBm or greater	
99	:	not known or not detectable	
<rsrq>	integer	N/A	Reference Signal Received Quality. For <rsrq> levels are mapped to range 0...7.
Values:			
0	:	-4...-3 dBm	
1	:	-6...-5 dBm	
2	:	-8...-7 dBm	
3	:	-10...-9 dBm	
4	:	-13...-11 dBm	
5	:	-15...-14 dBm	
6	:	-17...-16 dBm	
7	:	-19...-18 dBm	
99	:	not known or not detectable	



AT+CSQ=?

Test command returns values supported as compound values.

3.2.11. AT#SERVINFO - Serving Cell Information

This command reports information about the serving cell.

SIM Presence	Setting saved	Can be aborted	MAX timeout	SELINT
Not required	No	No	-	2



AT#SERVINFO

Execution command reports information about serving cell. The information and the format of the returned message depends on the network type.

GSM network

#SERVINFO:<BARFCN>,<dBM>,[<NetNameAsc>],<NetCode>,<BSIC>,<LAC>,<TA>,<GPRS>[,<PBARFCN>],[<NOM>],<RAC>,[PAT]]

LTE network

#SERVINFO:<EARFCN>,<dBM>,[<NetNameAsc>],<NetCode>,<PhysicalCellId>,<TAC>,<DRX>,<SD>,<RSRP>

The parameters are described in the Additional info sections.

Additional info:

- ▶▶ Parameters meaning.

Name	Type	Default	Description
<dBM>	integer	-	received signal strength in dBm.
<NetNameAsc>	string	-	operator name, quoted string or "" if network name is unknown.
<NetCode>	hex	-	country code and operator code.
<LAC>	integer	-	Localization Area Code
<BSIC>	string	-	Base Station Identification Code
<TA>	integer	-	Time Advance: it is available only if a GSM or GPRS is running.
<GPRS>	integer	0	GPRS supported in the cell
Values:			
	0	:	not supported
	1	:	supported
<BARFCN>	integer	-	BCCH ARFCN of the serving cell

- ▶▶ Parameters meaning.

Name	Type	Default	Description
<NOM>	string	N/A	Network Operator Mode.
Values:			

I : Network Mode I
 II : Network Mode II
 III : Network Mode III

<RAC> integer - Routing Area Color Code.

►► Parameters meaning.

Name	Type	Default	Description
<DRX>	integer	-	Discontinuous reception cycle length.
<SD>	integer	N/A	Service Domain
Values:			
	0		No Service
	1		CS only
	2		PS only
	3		CS & PS
<RSCP>	integer	-	Received Signal Code Power in dBm.
<EARFCN>	integer	-	LTE Assigned Radio Channel
<PhysicalCellId>	integer	-	Physical Cell ID
<TAC>	integer	-	Tracking Area Code
<RSRP>	integer	-	Reference Signal Received Power

►► Parameters meaning.

Name	Type	Default	Description
<PBARFCN>	integer	-	Not supported by 3GPP. PBCCH ARFCN of the serving cell; it is printed only if PBCCH is supported by the cell, otherwise the label " hopping " will be printed
<PAT>	integer	N/A	Priority Access Threshold.
Values:			
	0		Priority Access Threshold
	3-6		Priority Access Threshold

AT#SERVINFO=?

Test command returns **OK** result code.

3.2.12. AT#NWEN - Network Emergency Number Update

This command enables the unsolicited result code of emergency number update.

SIM Presence	Setting saved	Can be aborted	MAX timeout	SELINT
Not required	Specific profile	No	-	2



AT#NWEN=[<en>]

Set command enables/disables the URC for emergency number update. The URC format is:

#NWEN: <type>

The parameter is described in the Unsolicited field section.

Parameter:

Name	Type	Default	Description
<en>	integer	0	enables/disables unsolicited indication of emergency number update

Values:

- 0 : disable
- 1 : enable

Unsolicited field:

Name	Type	Description
<type>	integer	unsolicited indication of emergency number update

Values:

- 1 : number list update from internal ME
- 2 : number list update from SIM
- 3 : number list update from network

 Entering **AT#NWEN=** returns **OK** but has no effect.



AT#NWEN?

Read command reports whether the unsolicited indication of network emergency number update is currently enabled or not, in the format:

#NWEN: <en>



AT#NWEN=?

Test command reports the range for the parameter <en>

3.2.13. AT#PLMNUPDATE - Update PLMN List

This set command adds a new entry, or updates an already present one, in the module PLMN list stored in file system.

SIM Presence	Setting saved	Can be aborted	MAX timeout	SELINT
Required	Auto	No	-	2



AT#PLMNUPDATE[<action>,<MCC>,<MNC>[,<PLMNname>]]

Parameters:

Name	Type	Default	Description
<action>	integer	0	remove/update PLMN list items
Values:			
0	:		remove the entry with selected <MCC> and <MNC>. Parameter <PLMNname> is ignored
1	:		update the entry with selected <MCC> and <MNC> if it is already present, otherwise add it
<MCC>	integer	-	Mobile Country Code
<MNC>	integer	-	Mobile Network Code
<PLMNname>	string	-	name of the PLMN; string value, max length 30 characters.



#PLMNUPDATE command is accepted only if #PLMNMODE is set to 2.



AT#PLMNUPDATE?

Read command returns the list of entries added or updated with set command, in the format:

```
#PLMNUPDATE: <MCC>,<MNC>,<PLMNname>
#PLMNUPDATE: <MCC>,<MNC>,<PLMNname>
...
OK
```

The entries are listed in increasing order by MCC and MNC.



AT#PLMNUPDATE=?

Test command returns the range of <action> parameter and the maximum length of <MCC>, <MNC> and <PLMNname> parameters.

3.2.14. AT#PLMNMODE - PLMN List Selection

Set command is used to select the list of operator names to be used in **+COPN** command, and in internal researches for operator name matching given MCC and MNC.

SIM Presence	Setting saved	Can be aborted	MAX timeout	SELINT
Not required	Auto	No	-	2



AT#PLMNMODE=<mode>

Parameter:

Name	Type	Default	Description
<mode>	integer	1	list of operator names to be used for internal search

Values:

- 1 : internal hard coded list
- 2 : list is retrieved from a file in the file system



AT#PLMNMODE?

Read command reports whether the currently used list of PLMN names is fixed or not, in the format:

#PLMNMODE: <mode>



AT#PLMNMODE=?

Test command returns the supported range of values for parameter <mode>.

3.2.15. AT#BND - Select Band

This command selects RF bands

SIM Presence	Setting saved	Can be aborted	MAX timeout	SELINT
Not required	Auto	No	-	2



AT#BND=<band>[,<UMTS_band>[,<LTE_band>]]

Set command selects the current GSM, and LTE bands.

Parameters:

Name	Type	Default	Description
<band>	integer	N/A	GSM band selection. The default value depends on the product, therefore the default field shows a generic N/A.

Values:

- 0 : for 4G only products
- 5 : for 4G/2G products supporting: GSM 900 MHz + DCS 1800 MHz + PCS 1900 MHz + GSM 850 MHz

<UMTS_band>	integer	0	this parameter is used for backward compatibility.
-------------	---------	---	--

Value:

- 0 : for both 4G only and 4G/2G products.

<LTE_band>	integer	N/A	indicates the LTE supported bands expressed as the sum of Band number (1+2+8 ...) calculated as shown in the table (mask of 32 bits):
------------	---------	-----	---

Band number	Band i
1	B1
2	B2
4	B3
8	B4
...	...
(2exp(i-1))	Bi
...	...
2147483648	B32

Value:

- 1÷4294967295 : range of the sum of Band number (1+2+8 ...)



AT#BND?

Read command returns the current selected band in the format:

#BND: <band>,<UMTS_band>,<LTE_band>

**AT#BND=?**

Test command returns the supported range of values of parameters **<band>**, **<UMTS_band>** and **<LTE_band>**.



Test command

```
AT#BND=?  
#BND: (0-5),(0),(4-524420)  
OK
```

Read command

```
AT#BND?  
#BND: 5,0,524420  
OK
```

Read command shows that the supported LTE bands are: B3, B8, and B20

3.2.16. AT#AUTOBND - Automatic Band Selection

This command has no effect and is included only for backward compatibility.

SIM Presence	Setting saved	Can be aborted	MAX timeout	SELINT
Not required	Auto	No	-	2



AT#AUTOBND=[<value>]

Parameter:

Name	Type	Default	Description
<value>	integer	0	only for backward compatibility.

Values:

- 0 : only for backward compatibility.
- 1 : only for backward compatibility.
- 2 : only for backward compatibility.



AT#AUTOBND?

Read command returns the current value of the parameter <value> in the format:

#AUTOBND: <value>



AT#AUTOBND=?

Test command returns the supported values for parameter <value>.

3.2.17. AT#SNUM - Subscriber Number

This set command writes the MSISDN information related to the subscriber (own number) in the EFmsisdn SIM file.



3GPP TS 51.011

SIM Presence	Setting saved	Can be aborted	MAX timeout	SELINT
Required	No	No	-	2



AT#SNUM=<index>[,<number>[,<alpha>]]

Parameters:

Name	Type	Default	Description
<index>	integer	-	the number of the record in the EFmsisdn file in SIM where the number must be stored; its range goes from 1 to a maximum value that varies from SIM to SIM. If only <index> value is given, then the EFmsisdn record in location <index> is deleted.
<number>	string	-	string containing the phone number
<alpha>	string	-	alphanumeric string associated to <number> ; its maximum length varies from SIM to SIM. Default value is empty string (""), otherwise the used character set should be the one selected with +CSCS . The string could be written between quotes; the number of characters depends on the SIM. If empty string is given (""), the corresponding <alpha> will be an empty string.

- i** The command returns **ERROR** if EFmsisdn file is not present in the SIM, or if MSISDN service is not allocated and activated in the SIM Service Table, see 3GPP TS 51.011.



AT#SNUM=?

Test command returns the **OK** result code

3.2.18. AT#CEERNET - Extended Numeric Error Report for Network Reject Cause

The command is related to extended numeric error report.



3GPP TS 24.008
3GPP TS 24.301

SIM Presence	Setting saved	Can be aborted	MAX timeout	SELINT
Not required	Auto	No	-	2



AT#CEERNET

Execution command causes the TA to return a numeric code in the intermediate response format:

#CEERNET: <code>

which should offer the user of the TA a report for the last mobility management (MMGMM/EMM) or session management (SM/ESM) procedure not accepted by the network.

Additional info:

- ▶▶ • The following error codes are valid for mobility management (MM/GMM) or session management (SM), i.e. for 2G and 3G networks.
- In 4G network the <code>s meanings are included in tables 9.9.4.4.1 (for ESM causes) and 9.9.3.9.1 (for EMM cause) of 3GPP TS 24.301 Release 9.

Name	Type	Default	Description
<code>	integer	N/A	error code

Values:

- 2 : IMSI unknown in HLR
- 3 : illegal MS
- 4 : IMSI unknown in VISITOR LR
- 5 : IMEI not accepted
- 6 : illegal ME
- 7 : GPRS not allowed
- 8 : Operator determined barring (SM cause failure)/ GPRS and not GPRS not allowed (GMM cause failure)
- 9 : MS identity cannot be derived by network
- 10 : implicitly detached
- 11 : PLMN not allowed
- 12 : LA not allowed
- 13 : roaming not allowed
- 14 : GPRS not allowed in this PLMN

15	:	no suitable cells in LA
16	:	MSC TEMP not reachable
17	:	network failure
20	:	MAC failure
21	:	SYNCH failure
22	:	congestion
23	:	GSM authentication unacceptable
24	:	MBMS bearer capabilities insufficient for the service
25	:	LLC or SMDCP failure
26	:	insufficient resources
27	:	missing or unknown APN
28	:	unknown PDP address or PDP type
29	:	user authentication failed
30	:	activation rejected by GGSN
31	:	activation rejected unspecified
32	:	service option not supported
33	:	req. service option not subscribed
34	:	serv. option temporarily out of order
35	:	NSAPI already used
36	:	regular deactivation
37	:	QOS not accepted
38	:	call cannot be identified (MM cause failure) / SMN network failure (SM cause failure)
39	:	reactivation required
40	:	no PDP context activated (GMM cause failure) / feature not supported (SM cause failure)
41	:	semantic error in TFT operation
42	:	syntactical error in TFT operation
43	:	unknown PDP context
44	:	semantic err in PKT filter
45	:	syntactical err in PKT filter
46	:	PDP context without TFT activated
47	:	multicast group membership timeout
48	:	retry on new cell begin (if MM cause failure) / activation rejected BCM violation (if SM cause failure)
50	:	PDP type IPV4 only allowed
51	:	PDP type IPV6 only allowed
52	:	single address bearers only allowed
63	:	retry on new cell end
81	:	invalid transaction identifier

95	:	semantically incorrect message
96	:	invalid mandatory information
97	:	MSG type non-existent or not implemented
98	:	MSG type not compatible with protocol state
99	:	IE non-existent or not implemented
100	:	conditional IE error
101	:	MSG not compatible with protocol state
111	:	protocol error unspecified
112	:	APN restriction value incompatible with active PDP context

-  Telit recommends that the host controlling the modem defines the proper retry/reboot scheme for reject causes 2, 7, 11, 14, 30, 33, 34, 38.



AT#CEERNET=?

Test command returns **OK** result code.

3.2.19. AT#CEERNETEXT - Extended Error Report for Network Reject Cause

This command is both a set and an execution command.

SIM Presence	Setting saved	Can be aborted	MAX timeout	SELINT
Not required	No	No	-	2



AT#CEERNETEXT[=[<func>]]

Set command enables/disables the URC presentation or deletes the last network information. The execution command (**AT#CEERNETEXT<CR><LF>**) gets the last reject error information from the network and returns the following message:

#CEERNETEXT: <code>,<AcT>,<MCC>,<MNC>

If no error information is present, the execution command returns **OK**

When URC is enabled, it will occur every time a mobility management (MM/GMM/EMM) or session management (SM/ESM) procedure is not accepted by the network.

The URC message is equal to the message returned by the execution command.

Parameter:

Name	Type	Default	Description
<func>	integer	0	enable/disable the URC or delete the last network info

Values:

- 0 : disable the #CEERNETEXT URC
- 1 : enable the #CEERNETEXT URC
- 2 : delete last info of <code>, <AcT>, <MCC> and <MNC>

Unsolicited fields:

Name	Type	Description
<code>	integer	last numeric Network Reject Cause from network, see <code> in #CEERNET
<AcT>	integer	access technology of the registered network
		Values:
	0	: GSM
	8	: CAT-M
	9	: NB-IoT
<MCC>	string	Mobile Country Code of the used network when last numeric code was received
<MNC>	string	Mobile Network Code of the used network when last numeric code was received



AT#CEERNETEXT?

The read command returns the current value of parameter <func> in the format:

#CEERNETEXT: <func>

Additional info:

▶▶ Parameters returned by the read command.

Name	Type	Default	Description
<func>	integer	N/A	can assume the following values:

Values:

0 : #CEERTEXT URC is disabled

1 : #CEERTEXT URC is enabled



AT#CEERTEXT=?

Test command reports the supported range of values for the <func> parameter.

3.2.20. AT#CIPHIND - Ciphering Indication

This command enables/disables unsolicited result code for cipher indication.

SIM Presence	Setting saved	Can be aborted	MAX timeout	SELINT
Required	Auto	No	-	2



AT#CIPHIND=[<mode>]

Set command enables/disables unsolicited result code for cipher indication. The ciphering indicator feature allows to detect that ciphering is not switched on and to indicate this to the user. The ciphering indicator feature may be disabled by the home network operator setting data in the SIM/USIM. If this feature is not disabled by the SIM/USIM, then whenever a connection is in place, which is unenciphered, or changes from ciphered to unenciphered or vice versa, an unsolicited indication shall be given to the user. The format is:

#CIPHIND: <mode>

Parameter:

Name	Type	Default	Description
<mode>	integer	0	enable/disable #CIPHIND: unsolicited result code

Values:

- 0 : disable
- 1 : enable



AT#CIPHIND?

Read command reports the <mode>,<cipher> and <SIM/USIM flag>:

#CIPHIND: <mode>,<cipher>,<SIM/USIM flag>

Additional info:

- ▶▶ Here is the list of the parameters meaning returned by the read command.

Name	Type	Default	Description
<cipher>	integer	0	shows cipher status

Values:

- 0 : cipher off
- 1 : cipher on
- 2 : unknown (missing network information)

<SIM/USIM flag>	integer	0	SIM/USIM cipher status indication
-----------------	---------	---	-----------------------------------

Values:

- 0 : disabled
- 1 : enabled

2 : unknown (flag not read yet)



AT#CIPHIND=?

Test command reports the range for the parameter <mode>

3.2.21. AT#PSNT - Packet Service Network Type

The command enables/disables unsolicited result code for packet service network type (PSNT)

SIM Presence	Setting saved	Can be aborted	MAX timeout	SELINT
Required	Auto	No	-	2



AT#PSNT=[<mode>]

Set command enables/disables unsolicited result code for packet service network type (PSNT) having the following format:

#PSNT:<nt>

Parameter:

Name	Type	Default	Description
<mode>	integer	0	enables/disables PSNT unsolicited result code.

Values:

- 0 : disables PSNT unsolicited result code
- 1 : enables PSNT unsolicited result code
- 2 : PSNT unsolicited result code is enabled, and read command returns the message shown in the read section.

Unsolicited field:

Name	Type	Description
<nt>	integer	network type

Values:

- 0 : GPRS network
- 4 : LTE network
- 5 : unknown or not registered



AT#PSNT?

If <mode> is set to 0 or 1, read command returns the current values of the <mode> and <nt> parameters in the format:

#PSNT: <mode>,<nt>

If <mode> is set to 2, read command returns the current values of <mode> and <nt> parameters followed by four dummy parameters set to 0.

#PSNT:<mode>,<nt>,0,0,0,0



AT#PSNT=?

Test command reports the range for the parameter <mode>

3.2.22. AT#ENCALG - Set Encryption Algorithm

This command enables or disables the GSM and/or GPRS encryption algorithms supported by the module.

SIM Presence	Setting saved	Can be aborted	MAX timeout	SELINT
Not required	Auto	No	-	2





AT#ENCALG=[<encGSM>][,<encGPRS>]

Set command enables or disables the GSM and/or GPRS encryption algorithms supported by the module.

Parameters:

Name	Type	Default	Description
<encGSM>	integer	5	<p>The <encGSM> (one byte long) is a bit mask where each bit, when set, indicates the corresponding GSM encryption algorithm</p> <ul style="list-style-type: none"> • bit 0 = A5/1 • bit 1 = A5/2 • bit 2 = A5/3 • bits 3 - 7 = reserved for future use <p>Values:</p> <p>0 : no GSM encryption algorithm</p> <p>1÷7 : sum of integers each representing a specific GSM encryption algorithm: 1 – A5/1 2 – A5/2 4 – A5/3</p> <p>255 : reset the default values</p>
<encGPRS>	integer	7	<p>The <encGPRS> (one byte long) is a bit mask where each bit, when set, indicates the corresponding GPRS encryption algorithm</p> <ul style="list-style-type: none"> • bit 0 = GEA1 • bit 1 = GEA2 • bit 2 = GEA3 • bits 3 - 7 = reserved for future use <p>Values:</p> <p>0 : no GPRS encryption algorithm</p> <p>1÷7 : sum of integers each representing a specific GPRS encryption algorithm: 1 – GEA1 2 – GEA2 4 – GEA3</p> <p>255 : reset the default values</p>

-  The values are stored in NVM and available on following reboot.
-  For possible <encGSM> and <encGPRS> encryptions see test command response.
-  If no parameter is issued, the set command returns **ERROR**.



AT#ENCALG?

Read command reports the currently selected **<encGSM>** and **<encGPRS>**, and the last used **<usedGSM>** and **<usedGPRS>** in the format:

#ENCALG: <encGSM>,<encGPRS>,<usedGSM>,<usedGPRS>

Additional info:

►► Last used **<useGSM>** and **<useGPRS>** are expressed in the format:

Name	Type	Default	Description
<usedGSM>	integer	1	GSM encryption algorithm
Values:			
0	:	no GSM encryption algorithm	
1	:	A5/1	
2	:	A5/2	
3	:	A5/3	
255	:	not available	
<usedGPRS>	integer	3	GPRS encryption algorithms
Values:			
0	:	no GPRS encryption algorithm	
1,2	:	GEA1, GEA2	
4	:	GEA3	
255	:	not available	



AT#ENCALG=?

Test command reports the supported range of values for parameters in the format:
<encGSM> and **<encGPRS>**.



```
AT#ENCALG?  
#ENCALG: 5,2,1,1  
OK
```

```
AT#ENCALG=5,1  
OK
```

Sets the GSM encryption algorithm A5/1 and A5/3, and the GPRS encryption algorithm GEA1. It will be available at the next reboot.

```
AT#ENCALG?  
#ENCALG: 5,2,1,1
```

The last two values indicate that the last used GSM encryption algorithm is A5/1 and the last used GPRS encryption algorithm is GEA1

After reboot

```
AT#ENCALG?  
#ENCALG: 5,1,1,1
```

3.2.23. AT+CEMODE - Set Mode of Operation for EPS

This set command configures the mode of operation for EPS.



[1] 3GPP TS 24.301

SIM Presence	Setting saved	Can be aborted	MAX timeout	SELINT
Not required	Auto	No	-	2



AT+CEMODE=<mode>

Parameter:

Name	Type	Default	Description
<mode>	integer	0	mode of operation. The default value depends on product and the support of VoLTE. UE modes of operation can be found in standard [1]. Other values are reserved and will result in an ERROR response to the set command.

Values:

- 0 : PS mode 2 of operation
- 1 : CS/PS mode 1 of operation
- 2 : CS/PS mode 2 of operation
- 3 : PS mode 1 of operation



AT+CEMODE?

Read command returns the current value of parameter <mode> in the format:

+CEMODE: < mode >

-  The read command will return right values after set command, but effectively the mode of operation changes after power cycle.



AT+CEMODE=?

Test command returns the supported range of values of parameters <mode>.



```
Set EPS mode
AT+CEMODE=1
OK
```

```
Check EPS mode
AT+CEMODE?
+CEMODE: 1
OK
```

3.2.24. AT+CESQ - Extended Signal Quality

Execution command returns received signal quality parameters according to the network on which the module is registered.



- [1] 3GPP TS 27.007
- [2] 3GPP TS 45.008
- [3] 3GPP TS 25.133
- [4] 3GPP TS 36.133

SIM Presence	Setting saved	Can be aborted	MAX timeout	SELINT
Required	No	No	-	2



AT+CESQ

See Additional info section for networks on which the module can be registered.

Additional info:

- ▶▶ The execution command returns the following message. Its format depends on the network on which the module is registered.

2G Networks

+CESQ: <rxlev>,<ber>,255,255,255,255

LTE Networks

+CESQ: 99,99,255,255,<rsrq>,<rsrp>

Name	Type	Default	Description
<rxlev>	integer	N/A	received signal strength level, see 3GPP TS 45.008 subclause 8.1.4.

Values:

- 0 : rssi < -110 dBm
- 1 : -110 dBm ≤ rssi < -109 dBm
- 2 : -109 dBm ≤ rssi < -108 dBm
- ... : ...
- 61 : - 50 dBm ≤ rssi < - 49 dBm
- 62 : - 49 dBm ≤ rssi < -48 dBm
- 63 : - 48 dBm ≤ rssi
- 99 : not known or not detectable or if the current serving cell is not a GERAN cell

<ber>	integer	N/A	channel bit error rate.
-------	---------	-----	-------------------------

Values:

- 0÷7 : as RXQUAL values, see 3GPP TS 45.008 subclause 8.2.4

99 : not known or not detectable or if the current serving cell is not a GERAN cell

<rsrq>	integer	N/A	reference signal received quality, see 3GPP TS 36.133 subclause 9.1.7.
---------------------	---------	-----	--

Values:

0 : $\text{rsrq} < -19.5 \text{ dB}$

1 : $-19.5 \text{ dB} \leq \text{rsrq} < -19.0 \text{ dB}$

2 : $-19.0 \text{ dB} \leq \text{rsrq} < -18.5 \text{ dB}$

... : ...

32 : $-4 \text{ dB} \leq \text{rsrq} < -3.5 \text{ dB}$

33 : $-3.5 \text{ dB} \leq \text{rsrq} < -3 \text{ dB}$

34 : $-3 \text{ dB} \leq \text{rsrq}$

255 : not known or not detectable or if the current serving cell is not a E-UTRA cell

<rsrp>	integer	N/A	reference signal received power, see 3GPP TS 36.133 subclause 9.1.4.
---------------------	---------	-----	--

Values:

0 : $\text{rsrp} < -140 \text{ dBm}$

1 : $-140 \text{ dBm} \leq \text{rsrp} < -139 \text{ dBm}$

2 : $-139 \text{ dBm} \leq \text{rsrp} < -138 \text{ dBm}$

... : ...

95 : $-46 \text{ dBm} \leq \text{rsrp} < -45 \text{ dBm}$

96 : $-45 \text{ dBm} \leq \text{rsrp} < -44 \text{ dBm}$

97 : $-44 \text{ dBm} \leq \text{rsrp}$

255 : not known or not detectable or if the current serving cell is not a E-UTRA cell



AT+CESQ=?

Test command returns values supported as compound values.

3.2.25. AT#ENS - Enhanced Network Selection

Set command is used to activate the Enhanced Network Selection (ENS) functionality.



Cingular Wireless LLC Requirement

SIM Presence	Setting saved	Can be aborted	MAX timeout	SELINT
Not required	Auto	No	-	2



AT#ENS=[<mode>]

Parameter:

Name	Type	Default	Description
<mode>	integer	0	enable/disable ENS functionality

Values:

- 0 : disable
- 1 : enable

Additional info:

- ▶▶ If **AT#ENS=1** has been issued, at every next power-up SIM Application Toolkit will be enabled on user interface 0 if not previously enabled on a different user interface (**AT#STIA=2**).

The new setting will be available at the next power-up.



AT#ENS?

Read command reports whether the ENS functionality is currently enabled or not, in the format:

#ENS: <mode>



AT#ENS=?

Test command reports the available range of values for parameter **<mode>**

3.2.26. AT+WS46 - PCCA STD-101 Select Wireless Network

This command selects the cellular network (Wireless Data Service, WDS).



3GPP TS 27.007

SIM Presence	Setting saved	Can be aborted	MAX timeout	SELINT
Not required	Auto	No	-	2



AT+WS46=[<n>]

Set command selects the cellular network (Wireless Data Service, WDS) to operate with the **TA** (WDS-Side Stack Selection).

Parameter:

Name	Type	Default	Description
<n>	integer	N/A	WDS-Side Stack to be used by the TA .

- 4G/2G products support <n> parameter values 12, 28 and 30. 30 is factory default
- 4G only products support <n> parameter value 28

Values:

- 12 : GSM Digital Cellular Systems, GERAN only
- 28 : E-UTRAN only
- 30 : GERAN and E-UTRAN



<n> parameter setting is stored in NVM, and available at next reboot.



For NA (North America) products supporting AT&T requirement 13340 about RAT Balancing and EF-RAT Mode, the value <n> stored with **+WS46** command can be changed and overwritten in case of full SIM read, examples: power on; **AT+CFUN=4, AT+CFUN=1** sequence; SIM ejection, SIM insertion sequence.



AT+WS46?

Read command reports the currently selected cellular network, in the format:

+WS46: <n>



AT+WS46=?

Test command reports the range for the parameter <n>.

3.2.27. AT+CEDRXS - eDRX Setting

This command controls the setting of the UEs eDRX parameters.



3GPP TS 27.007
3GPP TS 24.008

SIM Presence	Setting saved	Can be aborted	MAX timeout	SELINT
Not required	Auto	No	-	2



AT+CEDRXS=[<mode>[,<AcTtype>[,<Req_eDRX>]]]

Set command controls the setting of the UEs eDRX parameters. The command controls whether the UE wants to apply eDRX or not, as well as the requested eDRX value for each specified type of access technology.

Parameters:

Name	Type	Default	Description
<mode>	integer	0	disable or enable the use of eDRX in the UE. This parameter is applicable to all specified types of access technology, i.e. the most recent setting of <mode> will take effect for all specified values of <AcTtype>.
Values:			
0	:	disable the use of eDRX	
1	:	enable the use of eDRX	
2	:	enable the use of eDRX and enable the unsolicited result code, see Additional info.	
3	:	disable the use of eDRX and discard all parameters for eDRX or, if available, reset to the manufacturer specific default values	
<AcTtype>	integer	N/A	type of access technology.
Values:			
0	:	Access technology is not using eDRX. This parameter value is only used in the unsolicited result code, it cannot be used in the set command.	
2	:	GSM (A/Gb mode)	
4	:	E-UTRAN (CAT M1 mode)	
5	:	E-UTRAN (NB1 mode)	
<Req_eDRX>	string	-	half a byte in a 4-bit format. The eDRX value refers to bit 4 to 1 of octet 3 of the Extended DRX parameters information element (see subclause 10.5.5.32 of 3GPP TS 24.008). For the coding and the value range, see Extended DRX parameters information element in 3GPP TS 24.008, Table 10.5.5.32/3GPP TS 24.008. Default value is "0000".

Additional info:

- If **<mode>=2** and there is a change in the eDRX parameters provided by the network, the unsolicited result code reports:

+CEDRXS: <AcTtype>[,<Req_eDRX>[,<NW_prove_DRX>[,<PagTimeWindow>]]]

Name	Type	Default	Description
<NW_prove_DRX>	string	-	half a byte in a 4-bit format. The eDRX value refers to bit 4 to 1 of octet 3 of the Extended DRX parameters information element (see subclause 10.5.5.32 of 3GPP TS 24.008). For the coding and the value range, see Extended DRX parameters information element in 3GPP TS 24.008 Table 10.5.5.32/3GPP TS 24.008.
<PagTimeWindow>	string	-	half a byte in a 4-bit format. The paging time window refers to bit 8 to 5 of octet 3 of the Extended DRX parameters information element (see subclause 10.5.5.32 of 3GPP TS 24.008). For the coding and the value range, see the Extended DRX parameters information element in 3GPP TS 24.008 Table 10.5.5.32/3GPP TS 24.008.



AT+CEDRXS?

Read command returns the current settings for each defined value of **<AcTtype>**, in format:

```
+CEDRXS: <AcTtype>,<Req_eDRX>[<CR><LF>
+CEDRXS: <AcTtype>,<Req_eDRX>[...]]
```



AT+CEDRXS=?

Test command returns the supported **<mode>**s and the value ranges for the access technology and the requested eDRX value as compound values.



```
AT+CEDRXS?
+CEDRXS: 4,"0000"
+CEDRXS: 5,"0000"
OK
```

3.2.28. AT#WS46 - Select IoT Technology

This command selects the IoT technology.

SIM Presence	Setting saved	Can be aborted	MAX timeout	SELINT
Not required	Auto	No	-	2



AT#WS46=<n>

Set command selects the IoT technology to operate with.

Parameter:

Name	Type	Default	Description
<n>	integer	0	select the technology to be used

Values:

- 0 : CAT-M1
- 1 : NB-IoT
- 2 : CAT-M1 (preferred) and NB-IoT
- 3 : CAT-M1 and NB-IoT (preferred)



The command takes effect after the module reboot.



AT#WS46?

Read command reports the currently selected technology, in the format:

#WS46: <n>



AT#WS46=?

Test command reports the range for the parameter <n>.

3.2.29. AT+CEDRXP - eDRX Read Dynamic Parameters

This command returns a message related to Extended Discontinuous Reception (eDRX).



3GPP TS 27.007
3GPP TS 24.008

SIM Presence	Setting saved	Can be aborted	MAX timeout	SELINT
Not required	No	No	-	2



AT+CEDRXP

Execution command returns the following message if eDRX is used for the cell that the MS is currently registered to, in the format:

+CEDRXP:<AcTtype>[,<Req_eDRX>[,<NW_prov_eDRX>[,<PagTimeWindow>]]]

If the cell that the MS is currently registered to is not using eDRX, **<AcTtype>=0** is returned.

Additional info:

- ▶▶ Here is the list of the meanings of the parameter returned by the **+CEDRXP** command.

Name	Type	Default	Description
<AcTtype>	integer	0	type of access technology.
Values:			
0	:		access technology is not using eDRX
2	:		see +CEDRXS.
4	:		see +CEDRXS.
5	:		see +CEDRXS.
<Req_eDRX>	string	-	see +CEDRXS.
<NW_prov_eDRX>	string	-	see +CEDRXS.
<PagTimeWindow>	string	-	see +CEDRXS.



AT+CEDRXP=?

Test command returns **OK** result code.

3.2.30. AT+CEREG - EPS Network Registration Status

This command monitors the Evolved Packet System (EPS) network registration status in LTE.



- [1] 3GPP TS 24.008
- [2] 3GPP TS 24.301
- [3] 3GPP TS 25.331

SIM Presence	Setting saved	Can be aborted	MAX timeout	SELINT
Not required	Specific profile	No	-	2



AT+CEREG=[<mode>]

Set command enables/disables the EPS network registration unsolicited result code (URC) in LTE, and selects one of the available formats:

short format: **+CEREG: <stat>**
 long format: **+CEREG: <stat>[,<tac>],[<ci>],[<AcT>]]**

<tac>, <ci>, and <AcT> are reported by the command only if available.

In case of error, possible response(s): **+CME ERROR: <err>**

Parameter:

Name	Type	Default	Description
<mode>	integer	0	enables/disables the network registration unsolicited result code (URC), and selects one of the available formats. The following events triggers the URC: <ul style="list-style-type: none"> • URC short format is displayed every time there is a change in the EPS network registration status • URC long format is displayed every time there is a change of network cell in LTE

Values:

- 0 : disable the network registration unsolicited result code
- 1 : enable the network registration unsolicited result code, and select the short format
- 2 : enable the network registration unsolicited result code, and selects the long format (includes the network cell identification data)

Unsolicited fields:

Name	Type	Description
<stat>	integer	EPS registration status

Values:

- 0 : not registered, terminal is not currently searching a new operator to register to
- 1 : registered, home network
- 2 : not registered, but terminal is currently searching a new operator to register to

		3	:	registration denied
		4	:	unknown. Example, out of LTE coverage
		5	:	registered, roaming
		6	:	registered for "SMS only", home network (not applicable)
		7	:	registered for "SMS only", roaming (not applicable).
		8	:	attached for emergency bearer services only. 3GPP TS 24.008 [8] and 3GPP TS 24.301 [83] specify the condition when the MS is considered as attached for emergency bearer services.
		9	:	registered for "CSFB not preferred", home network (not applicable).
		10	:	registered for "CSFB not preferred", roaming (not applicable).
<tac>	string	tracking area code (two bytes) in hexadecimal format (e.g. "00C3" equals 195 in decimal)		
<ci>	string	LTE cell ID (four bytes) in hexadecimal format		
<AcT>	integer	indicates the access technology of the serving cell.		
		Values:		
		0	:	GSM
		8	:	CAT M1
		9	:	NB IoT

**AT+CEREG?**

Read command returns the current value of **<mode>**, the registration status **<stat>**, and the information **<tac>**, **<ci>**, **<AcT>** according to the current **<mode>** parameter value.

+CEREG: <mode>,<stat>,[<tac>],[<ci>],[<AcT>]

**AT+CEREG=?**

Test command returns supported values for parameter **<mode>**.

3.2.31. AT#RFSTS - Read Current Network Status

Command reads current network status.

SIM Presence	Setting saved	Can be aborted	MAX timeout	SELINT
Required	No	No	-	2



AT#RFSTS

Execution command returns the current network status. The format of the returned message is according to the network on which the module is registered.

GSM network

#RFSTS:<PLMN>,<ARFCN>,<RSSI>,<LAC>,<RAC>,<TXPWR>,<MM>,<RR>,<NOM>,<CID>,<IMSI>,<NetNameAsc>,<SD>,<ABND>

Parameters	Description
<PLMN>	Country code and operator code (MCC, MNC)
<ARFCN>	GSM Assigned Radio Channel
<RSSI>	Received Signal Strength Indication
<LAC>	Localization Area Code
<RAC>	Routing Area Code
<TXPWR>	Tx Power

Parameter/values	Description
<MM>	Mobility Management state (for debug purpose only)
0	NULL
3	LOCATION UPDATING INITIATED
5	WAIT FOR OUTGOING MM CONNECTION
6	CONNECTION ACTIVE
7	IMSI DETACH INITIATED
8	PROCESS CM SERVICE PROMPT
9	WAIT FOR NETWORK COMMAND
10	LOCATION UPDATE REJECTED
13	WAIT FOR RR CONNECTION LOCATION UPDATE
14	WAIT FOR RR CONNECTION MM
15	WAIT FOR RR CONNECTION IMSI DETACH
17	WAIT FOR REESTABLISHMENT
18	WAIT FOR RR ACTIVE
19	IDLE
20	WAIT FOR ADDITIONAL OUTGOING MM CONNECTION
21	CONNECTION ACTIVE GROUP TRANSMIT
22	WAIT RR CONNECTION GROUP TRANSMIT
23	LOCATION UPDATING PENDING
24	IMSI DETACH PENDING
25	RR CONNECTION RELEASE NOT ALLOWED
255	UNKNOWN

Parameter/values	Description
<RR>	Radio Resource state (for debug purpose only)
2	CELL SELECTION

3	WAIT CELL SELECTION
4	DEACTIVATION CELL SELECTION
5	SELECT ANY CELL
6	WAIT SELECT ANY CELL
7	DEACTIVATION SELECT ANY CELL
8	WAIT INACTIVE
9	INACTIVE
10	WAIT IDLE
11	IDLE
12	PLMN SEARCH
13	CELL RESELECTION
14	WAIT CELL RESELECTION
15	DEACTIVATION PLMN SEARCH
16	CELL CHANGE
17	CS CELL CHANGE
18	WAIT CELL CHANGE
19	SINGLE BLOCK ASSIGNMENT
20	DOWNLINK TBF ESTABLISH
21	UPLINK TBF ESTABLISH
22	WAIT TBF
23	TRANSFER
24	WAIT SYNC
25	DTM ENHANCED CALL ESTABLISH
25	DTM
27	DTM ENHANCED MO CALL ESTABLISH
28	MO CONNECTION ESTABLISH
29	MT CONNECTION ESTABLISH
30	RR CONNECTION
31	DTM ESTABLISH
32	DTM RELEASE
33	CALL REESTABLISH
34	DEACTIVATION CALL REESTABLISH
35	NORMAL CHANNEL RELEASE
36	LOCAL CHANNEL RELEASE
37	DEACTIVATION
38	ENHANCED DTM CS CALL ESTABLISH
39	CELL RESELECTION TO UTRAN
40	DTM ENHANCED CS CALL ESTABLISH
41	INTER RAT ACTIVE ON HOLD
42	INTER RAT RESEL ABORT
43	INTER RAT WAIT INTER RAT
44	INTER RAT WAIT FOR RSRC
45	DSIM SUSPEND
46	DSIM WAIT SUSPEND
47	DSIM WAIT SUSPEND IDLE

Parameters	Descriptions
<NOM>	Network Operator Mode
<CID>	Cell ID
<IMSI>	International Mobile Subscriber Identity
<NetNameAsc>	Operator name

Parameter/values	Description
<SD>	Service Domain
0	No Service
1	CS only
2	PS only
3	CS+PS

Parameter/values	Description
<ABND>	Active Band
1	GSM 850
2	GSM 900
3	DCS 1800
4	PCS 1900

LTE network

#RFSTS:<PLMN>,<EARFCN>,<RSRP>,<RSSI>,<RSRQ>,<TAC>,<RAC>,[<TXPWR>],<DRX>,<MM>,<RRC>,<CID>,<IMSI>,[<NetNameAsc>],<SD>,<ABND>,<T3402>,<T3412>,<SINR>

Parameters	Description
<PLMN>	Country code and operator code(MCC, MNC)
<EARFCN>	E-UTRA Assigned Radio Channel
<RSRP>	Reference Signal Received Power
<RSSI>	Received Signal Strength Indication
<RSRQ>	Reference Signal Received Quality
<TAC>	Tracking Area Code
<RAC>	Routing Area Code
<TXPWR>	Tx Power (In traffic only)
<DRX>	Discontinuous reception cycle Length (cycle length in ms)

Parameter/values	Description
<MM>	Mobility Management state (for debug purpose only)
0	NULL
1	DEREGISTERED
2	REGISTRATION INITIATED
3	REGISTERED
4	TRACKING AREA UPDATE INITIATED
5	SERVICE REQUEST INITIATED
6	DEREGISTRATION INITIATED

Parameters	Description
<RRC>	Radio Resource state (for debug purpose only; see above)
<CID>	Cell ID

Parameter/values	Description
<IMSI>	International Mobile Station ID<SD> - Service Domain
0	No Service
1	CS only
2	PS only

3	CS+PS
---	-------

Parameters/values	Description
<ABND>	Active Band
1..63	According to 3GPP TS 36.101

Parameters	Description
<T3402>	Timer T3402 in seconds
<T3412>	Timer T3412 in seconds
<SINR>	Signal-to-Interface plus Noise Ratio

**AT#RFSTS=?**

Test command tests for command existence.

3.2.32. AT#SPN - Read SIM Field SPN

This command reads SIM fields SPN.

SIM Presence	Setting saved	Can be aborted	MAX timeout	SELINT
Required	Auto	No	-	2



AT#SPN

Execution command returns the service provider string contained in the SIM field SPN, in the format:

#SPN: <spn>

Unsolicited field:

Name	Type	Description
<spn>	string	service provider string contained in the SIM field SPN, represented in the currently selected character set, see +CSCS .



If the SIM field SPN is empty, the command returns the **OK** result code.



AT#SPN=?

Test command returns the **OK** result code.

3.2.33. AT#CEDRXS - Extended eDRX Setting

This command controls the setting of the UEs eDRX parameters.



3GPP TS 27.007
3GPP TS 24.008

SIM Presence	Setting saved	Can be aborted	MAX timeout	SELINT
Required	Auto	No	-	2



AT#CEDRXS=[<mode>[,<AcTtype>[,<Req_eDRX>[,<ReqPagTimeWindow>]]]]

Set command controls the setting of the UEs eDRX parameters. The command controls whether the UE wants to apply eDRX or not, as well as the requested eDRX value for each specified type of access technology.

Parameters:

Name	Type	Default	Description
<mode>	integer	0	disable or enable the use of eDRX in the UE. This parameter is applicable to all specified types of access technology, i.e. the most recent setting of <mode> will take effect for all specified values of <AcT>.
Values:			
0	:	disable the use of eDRX	
1	:	enable the use of eDRX	
2	:	enable the use of eDRX and enable the unsolicited result code, see Additional info.	
3	:	disable the use of eDRX and discard all parameters for eDRX or, if available, reset to the manufacturer specific default values	
<AcTtype>	integer	N/A	type of access technology.
Values:			
0	:	Access technology is not using eDRX. This parameter value is only used in the unsolicited result code, it cannot be used in the set command.	
2	:	GSM (A/Gb mode)	
4	:	E-UTRAN (CAT M1 mode)	
5	:	E-UTRAN (NB1 mode)	
<Req_eDRX>	string	-	half a byte in a 4 bit format. The eDRX value refers to bit-4 to 1 of octet 3 of the Extended DRX parameters information element (see subclause 10.5.5.32 of 3GPP TS 24.008). For the coding and the value range, see Extended DRX parameters information element in 3GPP TS 24.008, Table 10.5.5.32/3GPP TS 24.008. Default value is "0000"
<ReqPagTimeWindow>	string	-	half a byte in a 4-bit format. The paging time window refers to bit 8 to 5 of octet 3 of the

Extended DRX parameters information element (see subclause 10.5.5.32 of 3GPP TS 24.008). For the coding and the value range, see the Extended DRX parameters information element in 3GPP TS 24.008 Table 10.5.5.32/3GPP TS 24.008. Default value is "0000"

Additional info:

- ▶▶ If **<mode>=2** and there is a change in the eDRX parameters provided by the network, the unsolicited result code reports:

#CEDRXP:<AcTtype>[,<Req_eDRX>[,<NW_prov_eDRX>[,<ReqPagTimeWindow>[,<NW_prov_PagTimeWindow>]]]]]

Name	Type	Default	Description
<NW_prov_eDRX>	string	-	half a byte in a 4-bit format. The eDRX value refers to bit 4 to 1 of octet 3 of the Extended DRX parameters information element (see subclause 10.5.5.32 of 3GPP TS 24.008). For the coding and the value range, see Extended DRX parameters information element in 3GPP TS 24.008 Table 10.5.5.32/3GPP TS 24.008.
<NW_prov_PagTimeWindow>	string	-	half a byte in a 4-bit format. The paging time window refers to bit 8 to 5 of octet 3 of the Extended DRX parameters information element (see subclause 10.5.5.32 of 3GPP TS 24.008). For the coding and the value range, see the Extended DRX parameters information element in 3GPP TS 24.008 Table 10.5.5.32/3GPP TS 24.008



AT#CEDRXS?

Read command returns the current settings for each defined value of **<AcTtype>** in the format:

**#CEDRXS:<AcTtype>,<eDRX_act_state>,<Req_eDRX>,<ReqPagTimeWindow>[<CR><LF>
#CEDRXS:<AcTtype>,<eDRX_act_state>,<Req_eDRX>,<ReqPagTimeWindow>[...]]]**

Additional info:

- ▶▶ Meaning of the **<eDRX_act_state>** parameter.

Name	Type	Default	Description
<eDRX_act_state>	integer	0	eDRX status

Values:

0 : eDRX disabled

1 : eDRX enabled



AT#CEDRXS=?

Test command returns the supported **<mode>**s and the value ranges for the access technology, requested eDRX value and requested Paging Time Window as compound values.



AT#CEDRXS?

#CEDRXS: 2,0,"0000","0000"

#CEDRXS: 4,0,"0000","0000"

#CEDRXS: 5,0,"0000","0000"

OK

3.2.34. AT#MONI - Cell Monitor

This command is both a set and an execution command.

SIM Presence	Setting saved	Can be aborted	MAX timeout	SELINT
Required	No	No	-	2



AT#MONI[=[<number>]]

Set command sets one cell out of seven, in a neighbor list of the serving cell including it, from which extract GSM/LTE related information.

After entering the set command, enter the execution command **AT#MONI<CR>** to get the GSM/LTE related information for the selected cell and dedicated channel (if exists) in the format shown, for each network, in the Additional info section.

Parameter:

Name	Type	Default	Description
<number>	integer	-	the parameter meaning depends on the network, see Additional info section.

Additional info:

▶▶ GSM network

Name	Type	Default	Description
<number>	integer	0	GSM network

Values:

- 0÷6 : it is the ordinal number of the cell, in the neighbor list of the serving cell.
- 7 : it is a special request to obtain GSM-related information from the whole set of seven cells in the neighbor list of the serving cell

▶▶ LTE network

Name	Type	Default	Description
<number>	integer	0	LTE network

Values:

- 0 : it is the serving cell
- 1 : it is the intra-frequency cells
- 2 : it is the inter-frequency cells
- 3 : it is the W-CDMA neighbor cells, the report message is empty.
- 4 : it is the GSM neighbor cells
- 5,6 : it is not available

7 : it is a special request to obtain LTE-related information from the all available neighbor cells.

►► Execution command **AT#MONI**<CR> reports GSM/LTE related information for selected cell and dedicated channel (if exists) in the following formats:

a) When extracting data for the serving cell and the network name is known the format is:

GSM network

#MONI: <netname> **BSIC:**<bsic> **RxQual:**<qual> **LAC:**<lac> **Id:**<id> **ARFCN:**<arfcn> **PWR:**<dBm> **dBm TA:** <timadv>

LTE network

#MONI: <netname> **RSRP:**<rsrp> **RSRQ:**<rsrq> **TAC:**<tac> **Id:**<id> **EARFCN:**<earfcn> **PWR:**<dBm> **DRX:**<drx> **pci:**<physicalCellId> **QRxLevMin:**<QRxLevMin>

b) When the network name is unknown, the format is:

GSM network

#MONI: <cc> <nc> **BSIC:**<bsic> **RxQual:**<qual> **LAC:**<lac> **Id:**<id> **ARFCN:**<arfcn> **PWR:**<dBm> **dBm TA:** <timadv>

LTE network

#MONI: **Cc:**<cc> **Nc:**<nc> **RSRP:**<rsrp> **RSRQ:**<rsrq> **TAC:**<tac> **Id:**<id> **EARFCN:**<earfcn> **PWR:**<dBm> **DRX:**<drx> **pci:**<physicalCellId> **QRxLevMin:**<QRxLevMin>

c) When extracting data for an adjacent cell, the format is:

GSM network

#MONI: **Adj Cell**<n> [**LAC:**<lac> **Id:**<id>] **ARFCN:**<arfcn> **PWR:**<dBm>

LTE network

LTE intra-frequency and inter-frequency cells



#MONI: **RSRP:**<rsrp> **RSRQ:**<rsrq> **PhysCellId:**<physicalCellId> **EARFCN:**<earfcn> **PWR:**<dBm>

LTE GSM neighbor cells

#MONI: **Adj Cell**<n> **BSIC:**<bsic> **ARFCN:**<arfcn> **PWR:**<dBm>

Name	Type	Default	Description
<netname>	string	-	name of network operator
<cc>	string	-	country code
<nc>	string	-	network operator code
<n>	integer	-	progressive number of adjacent cell
<bsic>	string	-	base station identification code

<qual>	integer	-	quality of reception: 0..7
<lac>	string	-	localization area code
<id>	integer	-	cell identifier
<arfcn>	integer	-	assigned radio channel
<dBm>	integer	-	received signal strength in dBm.
<timadv>	integer	-	timing advance
<rscp>	integer	-	Received Signal Code Power in dBm.
<drx>	string	-	Discontinuous reception cycle length
<physicalCellId>	integer	-	physical cell identifier
<rsrp>	integer	-	Reference Signal Received Power
<rsrq>	integer	-	Reference Signal Received Quality
<tac>	integer	-	Tracking Area Code
<earfcn>	integer	-	E-UTRA Assigned Radio Channel
<QRxLevMin>	integer	-	minimum required RX level in the cell

-  TA: **<timadv>** reported only for the serving cell.
-  When **AT#MONI=7** is the last setting entered, the execution command **AT#MONI<CR>** reports the information previously listed for each of the cells in the neighbor of the serving cell. The information is formatting in a sequence of **<CR><LF>**-terminated strings.
-  The timing advance value is meaningful only during calls or GPRS transfers active.



AT#MONI=?

Test command reports the maximum number of cells, in a neighbor of the serving cell excluding it, from which we can extract GSM/LTE related information, along with the ordinal number of the current selected cell, in the format:

#MONI: (<MaxCellNo>,<CellSet>)

Additional info:

- ▶▶ Parameters meaning.

Name	Type	Default	Description
<MaxCellNo>	integer	-	maximum number of cells in a neighbor of the serving cell and excluding it from which we can extract GSM/LTE related information. This value is always 6 .
<CellSet>	integer	-	last setting done with command #MONI .



The module supports GSM network

```

AT+WS46?
+WS46: 30
OK
AT+CREG?
+CREG: 0,1
OK
AT#MONI=1
OK
AT#MONI=?
#MONI: (6,1)
OK
AT#MONI
#MONI: I TIM BSIC:25 RxQual:0 LAC:D5BD Id:3A27 ARFCN:1018 PWR:-72dbm TA:-1
OK
AT#MONI=7
OK
AT#MONI=?
#MONI: (6,7)
OK
AT#MONI
#MONI: Cell BSIC LAC CellId ARFCN Power C1 C2 TA RxQual PLMN
#MONI: S 25 D5BD 3A27 1018 -74dbm 31 31 4 7 I TIM
#MONI: N1 26 D5BD 3A26 1023 -79dbm -1 -1
#MONI: N2 21 D5BD 5265 1009 -78dbm -1 -1
#MONI: N3 27 D5BD 5266 13 -87dbm -1 -1
#MONI: N4 25 D5BD 5251 1020 -88dbm -1 -1
#MONI: N5 27 D5BD 5286 1011 -95dbm -1 -1
#MONI: N6 30 00D2 C5A0 16 -99dbm -1 -1

OK

```

3.3. Time & Alarm

3.3.1. AT+CCLK - Clock Management

The command is related to real time clock management.



3GPP TS 27.007

SIM Presence	Setting saved	Can be aborted	MAX timeout	SELINT
Not required	Auto	No	-	2



AT+CCLK=<time>

Set command sets the real-time clock of the module.

Parameter:

Name	Type	Default	Description
<time>	string	N/A	Current time as quoted string in the format: "yy/MM/dd, hh:mm:ss±zz,d"

Values:

- yy : year (two last digits are mandatory), range is 00..99
- MM : month (two digits are mandatory), range is 01..12
- dd : day (two digits are mandatory) The range for dd(day) depends either on the month and on the year it refers to. Available ranges are: (01..28) (01..29) (01..30) (01..31). Trying to enter an out of range value will raise an ERROR message.
- hh : hour (two digits are mandatory), range is 00..23
- mm : minute (two digits are mandatory), range is 00..59
- ss : seconds (two digits are mandatory), range is 00..59
- ±zz : time zone (indicates the difference, expressed in quarter of an hour, between the local time and GMT; two digits are mandatory), range is -96...+96



AT+CCLK?

Read command returns the current setting <time> of the real-time clock, in the format:

+CCLK: <time>

- i** The three last characters of <time>, i.e. the time zone information, are returned by AT+CCLK? only if the #NITZ URC 'extended' format has been enabled (see #NITZ).



AT+CCLK=?

Test command returns the OK result code.



Set date and time:
AT+CCLK="02/09/07,22:30:00+00"
OK

Read date and time:
AT+CCLK?
+CCLK: "02/09/07,22:30:25"
OK

3.3.2. AT+CALA - Alarm Management

This command is related to the alarm management.



3GPP TS 27.007

SIM Presence	Setting saved	Can be aborted	MAX timeout	SELINT
Not required	Auto	No	-	2



AT+CALA=<time>[,<n>[,<type>[,<text>[,<recurr>[,<silent>]]]]]

Set command stores in the internal Real Time Clock of the module an alarm time with respective settings.

It is possible to set up a recurrent alarm for one or more days in the week.

- Currently just one alarm can be set.
- Alarms are not supported after disconnecting from power. Coin cell are supported. In case of a power cut, alarm will be deleted and needs to be re-set.

When the RTC time reaches the alarm time then the alarm starts, the behavior of the module depends on the setting **<type>** and if the module was already ON at the moment when the alarm time had come.

Parameters:

Name	Type	Default	Description
<time>	string	-	current alarm time as quoted string in the format: "yy/MM/dd,hh:mm:ss±zz" Refer to +CCLK for the string meaning. Empty string (+CALA="") deletes the current alarm and resets all the +CALA parameters to the factory default configuration. "hh:mm:ss±zz" string must be used only when issuing +CALA with parameter <recurr> .
<n>	integer	0	index of the alarm Value: 0 : the only value supported
<type>	integer	1	alarm behavior type Values: 0 : reserved 1 : the module wakes up fully operative as if the ON/OFF button has been pressed. If the module is already ON when the alarm times out, then it does nothing. 2÷8 : see Additional info section.
<text>	string	-	alarm code text string used in the URC +CALA . It has meaning only if <type> is equal to 2, 5 or 6.
<recurr>	string	N/A	sets a recurrent alarm for one or more days in the week in the following format:

"X[,Y[,...]]"

where X, Y, ... can assume the following values:

Values:

- 0 : all days in the week
- 1 : Monday
- 2 : Tuesday
- 3 : Wednesday
- 4 : Thursday
- 5 : Friday
- 6 : Saturday
- 7 : Sunday

<silent> integer N/A indicates if the alarm is silent or not

Values:

- 0 : the alarm is not silent
 - 1 : the alarm is silent
-

Additional info:

▶▶ **<type>=2**

The module wakes up in "alarm mode" if at the alarm time it was powered OFF, otherwise it remains fully operative. In both cases the module issues an unsolicited code every 3 s:

+CALA: <text>

Where **<text>** is the **+CALA** optional parameter previously set.

The module keeps on sending the unsolicited code every 3 s until a **#WAKE** or **#SHDN** command is received or a 90 seconds timer expires. If the module is in "alarm mode" and it does not receive the **#WAKE** command within 90s then it shuts down.

▶▶ **<type>=3**

The module wakes up in "alarm mode" if at the alarm time it was powered OFF, otherwise it remains fully operative. In both cases the module starts playing the alarm tone on the selected path for the ringer (see command **#SRP**).

The module keeps on playing the alarm tone until a **#WAKE** or **#SHDN** command is received or a 90 s time-out occurs. If the device is in "alarm mode" and it does not receive the **#WAKE** command within 90s then it shuts down.

If alarm expires during a call alarm sound will stop when the call is disconnected.

▶▶ **<type>=4**

The module wakes up in "alarm mode" if at the alarm time it was off, otherwise it remains fully operative. In both cases the module brings the alarm pin high, provided that one has been set (using **#ALARMPIN** or **#GPIO**) and keeps it in this state until a **#WAKE** or **#SHDN** command is received or a 90 seconds timer expires. If the device is in "alarm mode" and it does not receive the **#WAKE** command within 90s then it shuts down.

▶▶ **<type>=5**

The module will make both the actions as for **<type>=2** and **<type>=3**.

▶▶ **<type>=6**

The module will make both the actions as for **<type>=2** and **<type>=4**.

▶▶ **<type>=7**

The module will make both the actions as for **<type>=3** and **<type>=4**.

▶▶ **<type>=8**

The module wakes up in "alarm mode" if at the alarm time it was off, otherwise it remains fully operative. In both cases the module sets high the RI output pin. The RI output pin remains high until next **#WAKE** issue or until a 90s timer expires. If the device is in "alarm mode" and it does not receive the **#WAKE** command within 90s. After that it shuts down.

-  The "alarm mode" is indicated by hardware pin CTS to the ON status and DSR to the OFF status, while the "power saving" status is indicated by a CTS - OFF, DSR - OFF and USB_VBUS - OFF status. The normal operating status is indicated by DSR - ON or USB_VBUS - ON status.

During the "alarm mode" the device will not make any network scan and will not register to any network and therefore is not able to dial or receive any call or SMS.

The only commands that can be issued to the module in this state are the **#WAKE** and **#SHDN**, every other command must not be issued during this state.



AT+CALA?

Read command returns the list of current active alarm settings in the device, in the following format:

[+CALA: <time>,<n>,<type>,<[text]>,<recurr>,<silent>]

Note: on READ command <time> does not include the time zone.



AT+CALA=?

Test command returns the list of supported index values, alarm types, maximum length of the text to be displayed in the URC **+CALA**, maximum length of **<recurr>** and supported **<silent>**s, in the format:

+CALA: (list of supported <n>s),(list of supported <type>s),<tlength>,<rlength>,(list of supported <silent>s)

Additional info:

►► Parameters:

Name	Type	Default	Description
<length>	string	-	maximum length of <text> parameter
<rlength>	string	-	maximum length of <recurr> parameter

</> AT+CALA="02/09/07,23:30:00+00"
OK

3.3.3. AT+CAPD - Postpone Alarm

Set command postpones or dismisses a currently active alarm.

SIM Presence	Setting saved	Can be aborted	MAX timeout	SELINT
Not required	Specific profile	No	-	2



AT+CAPD=[<sec>]

Parameter:

Name	Type	Default	Description
<sec>	integer	0	time in seconds to postpone the alarm.

Values:

- 0 : alarm is dismissed
- 1÷60 : postpone time

 Entering **AT+CAPS=** returns **OK** but has no effect.



AT+CAPD=?

Test command reports the supported range of values for parameter <sec>.

3.3.4. AT+CSDF - Setting Date Format

This command sets the date format of the date information presented to the user.

SIM Presence	Setting saved	Can be aborted	MAX timeout	SELINT
Not required	Specific profile	No	-	2



AT+CSDF=[<mode>[,<auxmode>]]

This command sets the date format of the date information presented to the user, which is specified by use of the **<mode>** parameter. The **<mode>** affects the date format on the phone display and doesn't affect the date format of the AT command serial interface, so it has no effect on our device.

The command also sets the date format of the TE-TA interface, which is specified by use of the **<auxmode>** parameter (i.e., the **<auxmode>** affects the **<time>** of **+CCLK** and **+CALA**).

Parameters:

Name	Type	Default	Description
<mode>	integer	1	phone display data format.
Values:			
1	:	DD-MMM-YYYY	
2	:	DD-MM-YY	
3	:	MM/DD/YY	
4	:	DD/MM/YY	
5	:	DD.MM.YY	
6	:	YYMMDD	
7	:	YY-MM-DD	
<auxmode>	integer	1	TE-TA interface data format.
Values:			
1	:	yy/MM/dd	
2	:	yyyy/MM/dd	

- i** The **<time>** format of **+CCLK** and **+CALA** is:
 - "yy/MM/dd,hh:mm:ss+zz" when **<auxmode>=1**
 - "yyyy/MM/dd,hh:mm:ss+zz" when **<auxmode>=2**
- i** If the parameters are omitted (**AT+CSDF=**), then this command sets the default value of **<mode>**.



AT+CSDF?

Read command reports the currently selected **<mode>** and **<auxmode>** in the format:

+CSDF: <mode>,<auxmode>

**AT+CSDF=?**

Test command reports the supported range of values for parameters **<mode>** and **<auxmode>**.



- **AT+CSDF?**
+CSDF: 1,1
OK

AT+CCLK?
+CCLK: "00/01/02,03:42:08+00"
OK
- **AT+CSDF=1,2**
OK

AT+CCLK?
+CCLK: "2000/01/02,03:42:23+00"
OK

3.3.5. AT+CTZR - Time Zone Reporting

This command enables and disables the time zone change event reporting.

SIM Presence	Setting saved	Can be aborted	MAX timeout	SELINT
Not required	Specific profile	No	-	2



AT+CTZR=<onoff>

Set command permits to enable/disable the time zone change event reporting.

If the reporting is enabled and whenever the time zone is changed, the MT returns the unsolicited result code:

+CTZV: <tz>

Parameter:

Name	Type	Default	Description
<onoff>	string	0	enable/disable the time zone change event reporting.

Values:

- 0 : Disable time zone change event reporting
- 1 : Enable time zone change event reporting

Unsolicited field:

Name	Type	Description
<tz>	string	New time zone.



AT+CTZR?

Read command reports the currently selected <onoff> in the format:

+CTZR: <onoff>



AT+CTZR=?

Test command reports the supported range of values for parameter <onoff>

3.3.6. AT+CTZU - Automatic Time Zone Update

Set command enables/disables the automatic time zone update via NITZ.



3GPP TS 27.007

SIM Presence	Setting saved	Can be aborted	MAX timeout	SELINT
Required	Specific profile	No	-	2





AT+CTZU=<onoff>

Parameter:

Name	Type	Default	Description
<onoff>	integer	0	enables/disables the automatic time zone update via NITZ

Values:

- 0 : disable
- 1 : enable

-  The command **+CTZU** is the ETSI standard equivalent of Telit custom command **#NITZ** (for the date and time update functionality).
-  Despite of the name, the command **+CTZU** enables automatic update of the date and time set by **+CCLK** command (not only time zone). This happens when a Network Identity and Time Zone (NITZ) message is sent by the network.
If the automatic date and time update functionality has been enabled by **+CTZU** or **#NITZ** (or both), NITZ message will cause a date and time update.



AT+CTZU?

Read command reports the current setting of <onoff> in the format:

+CTZU: <onoff>



AT+CTZU=?

Test command returns the supported values of parameter <onoff>.

3.3.7. AT#NITZ - Network Identity and Time Zone

This command handles Network Identity and Time Zone.

SIM Presence	Setting saved	Can be aborted	MAX timeout	SELINT
Required	Other	No	-	2



AT#NITZ=[<val>[,<mode>]]

Set command enables/disables the automatic date/time updating and the Full Network Name applying. It enables also the #NITZ URC in the format:

#NITZ: <datetime>

and permits to change its format.

Parameters:

Name	Type	Default	Description
<val>	integer	7	<p>identifies the functionalities to enable. The <val> parameter is a sum of integer values, where every value corresponds to a functionality:</p> <ul style="list-style-type: none"> • 1 - enables automatic date/time updating • 2 - enables Full Network Name applying • 4 - sets the #NITZ URC 'extended' format (see <datetime> below) • 8 - sets the #NITZ URC 'extended' format with Daylight Saving Time (DST) support (see <datetime> below)

Values:

- 0 : disables every functionality
- 1÷15 : sum of integer values

<mode>	integer	0	enables/disables the #NITZ URC
--------	---------	---	--------------------------------

Values:

- 0 : disables the URC
- 1 : enables the URC

Unsolicited field:

Name	Type	Description
<datetime>	string	<p>string format depends on parameter <val></p> <ul style="list-style-type: none"> • "yy/MM/dd, hh:mm:ss" - 'basic' format, if <val> is in (0..3) • "yy/MM/dd, hh:mm:ss±zz" - 'extended' format, if <val> is in (4..7) • "yy/MM/dd, hh:mm:ss±zz,d" - 'extended' format with DST support, if <val> is in (8..15)

For the meaning of the <datetime> subfields, please check +CCLK and #CCLK commands

-
- If the DST information isn't sent by the network, then the **<datetime>** parameter will have the format "**yy/MM/dd, hh:mm:ss±zz**".
 - Date and time information can be sent by the network after GSM registration or after PS attach.
-

**AT#NITZ?**

Read command reports whether

- automatic date/time updating
- Full Network Name applying
- **#NITZ** URC (as well as its format)

are currently enabled or not in the format:

#NITZ: <val>, <mode>

**AT#NITZ=?**

Test command returns supported values of parameters **<val>** and **<mode>**.



The command parameters are stored in two different profiles:

- **<val>** must be valid for all AT instances, so its value is entered in Common profile (extended section).
- **<mode>** must be valid only for the AT instance where it has been set, so its value is entered in Specific profile (extended section).

Use the **#W[<n>]** command to store the updated profiles in NVM.

3.3.8. AT#CCLK - Clock Management

The command is related to real time clock management.

SIM Presence	Setting saved	Can be aborted	MAX timeout	SELINT
Not required	Auto	No	-	2



AT#CCLK=<time>

Set command sets the real-time clock of the module.

Parameter:

Name	Type	Default	Description
<time>	string	N/A	Current time as quoted string in the format: "yy/MM/dd,hh:mm:ss±zz,d"

Values:

- yy : year (two last digits are mandatory), range is 00..99
- MM : month (two digits are mandatory), range is 01..12
- dd : day (two digits are mandatory) The range for dd(day) depends either on the month and on the year, it refers to. Available ranges are: (01..28) (01..29) (01..30) (01..31). Trying to enter an out of range value will raise an ERROR message.
- hh : hour (two digits are mandatory), range is 00..23
- mm : minute (two digits are mandatory), range is 00..59
- ss : seconds (two digits are mandatory), range is 00..59
- ±zz : time zone (indicates the difference, expressed in quarter of an hour, between the local time and GMT; two digits are mandatory), range is: -96..+96
- d : number of hours added to the local TZ because of Daylight Saving Time (summertime) adjustment; range is 0-2.



AT#CCLK?

Read command returns the current setting of the real-time clock, in the format <time>.

If the time is set by the network but the DST information is missing, or the time is set by +CCLK command, then the <time> format is:

"yy/MM/dd,hh:mm:ss±zz"



If the time is set by the network but the Daylight-Saving Time (DST) information is missing, or the time is set by +CCLK command, then the <time> format is:

"yy/MM/dd,hh:mm:ss±zz"



AT#CCLK=?

Test command returns the **OK** result code.



Set command:
AT#CCLK="02/09/07,22:30:00+04,1"
OK

Read command:
AT#CCLK?
#CCLK: "02/09/07,22:30:25+04,1"
OK

3.3.9. AT#CCLKMODE - Clock Mode

This command allows to enable the local time or the UTC time.

SIM Presence	Setting saved	Can be aborted	MAX timeout	SELINT
Not required	Auto	No	-	2



AT#CCLKMODE=<mode>

Set command enables the local time or the UTC time in **+CCLK** and **#CCLK** commands and in **#NITZ URC**

Parameter:

Name	Type	Default	Description
<mode>	integer	0	Time and date mode

Values:

- 0 : Local time + local time zone offset
- 1 : UTC time + local time zone offset



AT#CCLKMODE?

Read command reports whether the local time or the UTC time is enabled, in the format:

#CCLKMODE: <mode>



AT#CCLKMODE=?

Test command reports the supported range of values for parameter **<mode>**



Example of the two clock mode settings:

```
AT#CCLKMODE?  
#CCLKMODE: 0  
OK  
#NITZ: 13/03/05,15:20:33+04,0  
AT+CCLK?  
+CCLK: "13/03/05,15:20:37+04"  
OK  
AT#CCLKMODE=1  
OK  
AT+CCLK?  
+CCLK: "13/03/05,14:20:45+04"  
OK  
AT#CCLKMODE?  
#CCLKMODE: 1  
OK  
#NITZ: 13/03/05,14:20:53+04,0  
AT+CCLK?  
+CCLK: "13/03/05,14:20:55+04"  
OK  
AT#CCLKMODE=0  
OK  
AT+CCLK?  
+CCLK: "13/03/05,15:20:59+04"  
OK
```

3.3.10. AT#WAKE - Wake from Alarm Mode

Stop any alarm activity

SIM Presence	Setting saved	Can be aborted	MAX timeout	SELINT
Not required	No	No	-	2



AT#WAKE=<opmode>

Execution command stops any eventually present alarm activity and, if the module is in alarm mode, it exits the alarm mode and enters the normal operating mode.

Parameter:

Name	Type	Default	Description
<opmode>	integer	0	operating mode

Value:

- 0 : normal operating mode; the module exits the alarm mode and enters the normal operating mode, any alarm activity is stopped (e.g. alarm tone playing) and an OK result code is returned.

-  If **#WAKE=0** command is issued after an alarm has been set with **+CALA** command, but before the alarm has expired, it will answer **OK** but have no effect.



AT#WAKE?

Read command returns the operating status of the device in the format:

#WAKE: <status>

where:

<status>

0 - normal operating mode



1 - alarm mode or normal operating mode with some alarm activity.



AT#WAKE=?

Test command returns **OK** result code.



-  The alarm mode is indicated by status ON of hardware pin CTS and by status ON of pin DSR; the power saving status is indicated by a CTS - OFF and DSR - OFF status; the normal operating status is indicated by DSR - ON.
-  During the alarm mode the device will not make any network scan and will not register to any network and therefore is not able to dial or receive any call or SM, the only commands that can be issued to the MODULE in this state are the **#WAKE** and **#SHDN**, every other command must not be issued during this state.

3.3.11. AT+CSTF - Setting Time Format

Set command sets the time format of the time information presented to the user, which is specified by use of the **<mode>** parameter.



3GPP TS 27.007

SIM Presence	Setting saved	Can be aborted	MAX timeout	SELINT
Not required	Specific profile	No	-	2



AT+CSTF=[<mode>]

Parameter:

Name	Type	Default	Description
<mode>	integer	1	<mode> affects the time format on the phone display and doesn't affect the time format of the AT command serial interface, so it not actually not used

Values:

- 1 : [hh]:[mm] (24 hour clock)
- 2 : [hh]:[mm] (a.m./p.m.)



Entering **AT+CSTF=** returns **OK** but has no effect.



AT+CSTF?

Read command reports the currently selected **<mode>** in the format:

+CSTF: <mode>.



AT+CSTF=?

Test command reports the supported range of values for parameter **<mode>**.

3.3.12. AT+CALD - Delete Alarm

This command deletes an alarm in the ME.



3GPP TS 27.007

SIM Presence	Setting saved	Can be aborted	MAX timeout	SELINT
Not required	No	No	-	2



AT+CALD=<n>

Parameter:

Name	Type	Default	Description
<n>	integer	N/A	alarm index

Value:

0 : alarm index



AT+CALD=?

Test command reports the range of supported values for <n> parameter.

3.4. SMS & CB

3.4.1. AT+CSMS - Select Message Service

Set command selects messaging service <service>



3GPP TS 27.005
3GPP TS 23.040
3GPP TS 23.041

SIM Presence	Setting saved	Can be aborted	MAX timeout	SELINT
Required	Auto	No	-	2



AT+CSMS=[<service>]

Set command selects messaging service <service>. It returns the types of messages supported by the ME:

+CSMS: <mt>,<mo>,<bm>

For parameters meaning see Additional info section.

Parameter:

Name	Type	Default	Description
<service>	integer	0	Select Message Service

Values:

- 0 : 3GPP TS 23.040 and 3GPP TS 23.041. The syntax of SMS AT commands is compatible with 3GPP TS 27.005
- 1 : 3GPP TS 23.040 and 3GPP TS 23.041. The syntax of SMS AT commands is compatible with 3GPP TS 27.005. The requirement of <service> setting 1 is mentioned under corresponding command descriptions

Additional info:

- ▶▶ Parameters meaning of the returned message.

Name	Type	Default	Description
<mt>	integer	0	mobile terminated messages support:

Values:

- 0 : type not supported
- 1 : type supported

<mo>	integer	0	mobile originated messages support
------	---------	---	------------------------------------

Values:

0 : type not supported
 1 : type supported

<bm>	integer	0	broadcast type messages support
-------------------	---------	---	---------------------------------

Values:

0 : type not supported
 1 : type supported



AT+CSMS?

Read command reports current service setting along with supported message types in the format:

+CSMS: <service>, <mt>, <mo>, <bm>



AT+CSMS=?

Test command reports the supported value of the parameter **<service>**

3.4.2. AT+CPMS - Preferred Message Storage

The command selects the memory storage used by SMS (Short Messages).



3GPP TS 27.005

SIM Presence	Setting saved	Can be aborted	MAX timeout	SELINT
Required	Auto	No	-	2



AT+CPMS=<memr>[,<memw>[,<mems>]]

Set command selects memory storages <memr>, <memw> and <mems> to be used for reading, writing, sending and storing SMS

The command returns the memory storage status in the format:

+CPMS: <usedr>,<totalr>,<usedw>,<totalw>,<useds>,<totals>

The returned parameters are described in the Additional info section.

Parameters:

Name	Type	Default	Description
<memr>	string	SE	memory from which messages are read and deleted
Values:			
ME	:	SMS memory storage in Flash	
SE	:	SIM SMS memory storage	
<memw>	string	SM	memory to which writing and sending operations are made
Values:			
ME	:	SMS memory storage in Flash	
SM	:	SIM SMS memory storage	
<mems>	string	SM	memory to which received SMS are preferred to be stored
Values:			
ME	:	SMS memory storage in Flash	
SM	:	SIM SMS memory storage	

Additional info:

- ▶▶ Here is the meaning of the parameters returned by the command.

Name	Type	Default	Description
<usedr>	integer	-	number of SMS stored in <memr>
<totalr>	integer	-	max number of SMS that <memr> can contain
<usedw>	integer	-	number of SMS stored in <memw>
<totalw>	integer	-	max number of SMS that <memw> can contain

<useds>	integer	-	number of SMs stored in <mems>
<totals>	integer	-	max number of SMs that <memw> can contain

**AT+CPMS?**

Read command reports the message storage status.

+CPMS:<memr>,<usedr>,<totalr>,<memw>,<usedw>,<totalw>,<mems>,<useds>,<totals>

The parameters are described in previous sections.

**AT+CPMS=?**

Test command reports the supported values for parameters **<memr>**, **<memw>** and **<mems>**.



```
AT+CPMS="SM","ME","SM"
+CPMS: 1,20,27, 50,1,20
OK
```

```
AT+CPMS?
+CPMS: "SM",1,20,"ME",27, 50,"SM",1,20
OK
```

You have 1 out of 20 SMS SIM positions occupied

3.4.3. AT+CMGF - Message Format

Selects the format of SMS messages to be used in following SMS commands.



- 3GPP TS 27.005

SIM Presence	Setting saved	Can be aborted	MAX timeout	SELINT
Required	Specific profile	No	-	2



AT+CMGF=[<mode>]

Set command selects the format of SMS messages used with send, list, read and write commands.

Parameter:

Name	Type	Default	Description
<mode>	integer	0	format to use for SMS operations

Values:

- 0 : PDU mode
- 1 : text mode



AT+CMGF?

Read command reports the current value of the parameter <mode> in the format:

+CMGF: <mode>



AT+CMGF=?

Test command returns the supported values of parameter <mode>.

3.4.4. AT+CSCA - Service Center Address

This command allows to set the Service Center Address for SMS transmissions.



3GPP TS 27.005

SIM Presence	Setting saved	Can be aborted	MAX timeout	SELINT
Required	Other	No	-	2



AT+CSCA=<number>[,<type>]

Set command sets the Service Center Address to be used for mobile originated SMS transmissions

Parameters:

Name	Type	Default	Description
<number>	string	-	String type phone number of forwarding address in format specified by <type> parameter
<type>	integer	145	The type of number

Values:

129	:	National numbering scheme
145	:	International numbering scheme (contains the character "+")



AT+CSCA?

Read command reports the current value of the SCA in the format:

+CSCA: <number>,<type>



-  If SCA is not present the device reports an error message.



AT+CSCA=?

Test command returns the **OK** result code.



-  To use the SM service, is mandatory to set a Service Center Address at which service requests will be directed.
-  In Text mode, this setting is used by send and write commands; in PDU mode, setting is used by the same commands, but only when the length of the SMSC address coded into the <pdu> parameter equals zero.
-  The current settings are stored through **+CSAS**



```
AT+CSCA="+821029190903",145  
OK
```

```
AT+CSCA?  
+CSCA: "+821029190903",145  
OK
```

3.4.5. AT+CSMP - Set Text Mode Parameters

This command is used to select values for additional parameters for storing and sending SMS when the text mode is used (**AT+CMGF=1**).



3GPP TS 27.005
 3GPP TS 03.40/23.040
 3GPP TS 03.38/23.038

SIM Presence	Setting saved	Can be aborted	MAX timeout	SELINT
Required	Other	No	-	2



AT+CSMP=[<fo>[,<vp>[,<pid>[,<dcs>]]]]

Set command is used to select values for additional parameters for storing and sending SMS when the text mode is used (**AT+CMGF=1**).

Parameters:

Name	Type	Default	Description
<fo>	integer	-	depending on the command or result code: first octet of 3GPP TS 03.40/23.040 SMS-DELIVER, SMS-SUBMIT (default 17), SMS-STATUS-REPORT, or SMS-COMMAND (default 2) in integer format.
<vp>	mixed	-	depending on SMS-SUBMIT <fo> setting: 3GPP TS 03.40/23.040 TP-Validity-Period either in integer format (default 167) or in quoted time-string format.
<pid>	integer	-	3GPP TS 03.40/23.040 TP-Protocol-Identifier in integer format.
<dcs>	integer	-	depending on the command or result code: 3GPP TS 03.38/23.038 SMS Data Coding Scheme (default 0), or Cell Broadcast Data Coding Scheme.



AT+CSMP?

Read command returns the current setting in the format:

+CSMP: <fo>,<vp>,<pid>,<dcs>



AT+CSMP=?

Test command returns the **OK** result code.



The current settings are stored through **+CSAS**



Set the parameters for an outgoing message with 24 hours of validity period and default properties:

```
AT+CSMP=17,167,0,0  
OK
```

3.4.6. AT+CSDH - Show Text Mode Parameters

This command controls whether detailed header information is shown in text mode.



3GPP TS 27.005

SIM Presence	Setting saved	Can be aborted	MAX timeout	SELINT
Required	Specific profile	No	-	2



AT+CSDH=[<show>]

Set command controls whether detailed header information is shown in text mode (**AT+CMGF=1**) result codes.

Parameter:

Name	Type	Default	Description
<show>	integer	0	control the display of the result codes.

Values:

- 0 : see Additional info section
- 1 : show the values in result codes

Additional info:

▶▶ If <show>=0

do not show header values defined in commands **+CSCA** and **+CSMP** (<sca>,<tosca>,<fo>,<vp>,<pid> and <dcs>) nor <length>,<toda> or <toa> in **+CMT**, **+CMGL**, **+CMGR** result codes for SMS-DELIVERs and SMS-SUBMITs in text mode.

For SMS-COMMANDs in **+CMGR** result code do not show <pid>,<mn>,<da>,<toda>,<length> or <cdata>



AT+CSDH?

Read command reports the current setting in the format:

+CSDH: <show>



AT+CSDH=?

Test command reports the supported range of values for parameter <show>.

3.4.7. AT+CSAS - Save Settings

Execution command saves settings which have been made by the **+CSCA**, **+CSMP** and **+CSCB** commands in local non-volatile memory.



3GPP TS 27.005

SIM Presence	Setting saved	Can be aborted	MAX timeout	SELINT
Required	No	No	-	2





AT+CSAS[=<profile>]

Parameter:

Name	Type	Default	Description
<profile>	integer	0	Index of the profile where the settings are saved

Values:

- 0 : it saves the settings to NVM
- 1÷n : SIM profile number; the value of <n> depends on the SIM.

-  Certain settings may not be supported by the SIM and therefore they are always saved to NVM, regardless the value of <profile>.
-  If parameter is omitted (**AT+CSAS<CR>** is given) the settings are saved in the non-volatile memory.



AT+CSAS=?

Test command returns the possible range of values for the parameter <profile>.

3.4.8. AT+CRES - Restore Settings

Execution command restores message service settings saved by **+CSAS** command from either NVM or SIM.



3GPP TS 27.005

SIM Presence	Setting saved	Can be aborted	MAX timeout	SELINT
Not required	No	No	-	2





AT+CRES[=<profile>]

Parameter:

Name	Type	Default	Description
<profile>	integer	N/A	Defines which message service profiles to restore.

Values:

- 0 : restores message service settings from NVM
- 1÷n : restores message service settings from SIM. The n value depends on the SIM.

-  Certain settings may not be supported by the SIM and therefore they are always restored from NVM, regardless the value of **<profile>**
-  If parameter is omitted the command restores message service settings from NVM.



AT+CRES=?

Test command returns the possible range of values for the parameter **<profile>**.

3.4.9. AT+CMMS - More Message to Send

Set command controls the continuity of SMS relay protocol link. When feature is enabled (and supported by network) multiple messages can be sent much faster as link is kept open.



3GPP TS 27.005

SIM Presence	Setting saved	Can be aborted	MAX timeout	SELINT
Required	No	No	-	2



AT+CMMS=[<n>]

Parameter:

Name	Type	Default	Description
<n>	integer	0	enables/disables the relay protocol link continuity.

Values:

- 0 : disable
- 1 : keep enabled until the time between the response of the latest message send command (+CMGS, +CMSS, etc.) and the next send command exceeds 5 seconds, then the link is closed and the parameter <n> is automatically reset to 0
- 2 : enable (if the time between the response of the latest message send command and the next send command exceeds 5 seconds, the link is closed but the parameter <n> remains set to 2)

 Entering **AT+CMMS=** returns **OK** but has no effect.



AT+CMMS?

Read command reports the current value of the parameter <n> in the format:

+CMMS: <n>



AT+CMMS=?

Test command returns the range of supported <n>

3.4.10. AT+CNMI - New Message Indications to Terminal Equipment

This command sets the parameters for receiving SMS messages.



3GPP TS 27.005

SIM Presence	Setting saved	Can be aborted	MAX timeout	SELINT
Not required	Specific profile	No	-	2



AT+CNMI=[<mode>[,<mt>[,<bm>[,<ds>[,<bfr>]]]]]

Set command selects the behavior of the device on how the receiving of new messages from the network is indicated to the DTE.

Parameters:

Name	Type	Default	Description
<mode>	integer	0	unsolicited result codes buffering option.

Values:

- 0 : Buffer unsolicited result codes in the TA. If TA result code buffer is full, indications can be buffered in some other place or the oldest indications may be discarded and replaced with the new received indications.
- 1 : Discard indication and reject new received message unsolicited result codes when TA-TE link is reserved, otherwise forward them directly to the TE.
- 2 : Buffer unsolicited result codes in the TA in case the DTE is busy and flush them to the TE after reservation. Otherwise forward them directly to the TE.
- 3 : if <mt> is set to 1, it enables the hardware ring line for 1 sec.

<mt>	integer	0	result code indication reporting for SMS-DELIVER.
------	---------	---	---

Values:

- 0 : No SMS-DELIVER indications are routed to the TE and message is stored.
- 1 : If SMS-DELIVER is stored into ME/TA, indication of the memory location is routed to the TE using the URC described in Additional info section.
- 2 : SMS-DELIVERs (except class 2 messages and messages in the message waiting indication group) are routed directly to the TE using the URC described in the Additional info section.
- 3 : Class 3 SMS-DELIVERs are routed directly to TE using unsolicited result codes defined in <mt>=2. Messages of other data coding schemes result in indication as defined in <mt>=1.

<bm>	integer	0	broadcast reporting option
------	---------	---	----------------------------

Values:

- 0 : Cell Broadcast Messages are not sent to the DTE
- 2 : New Cell Broadcast Messages are sent to the DTE with the URC described in Additional info section.

<ds>	integer	0	SMS-STATUS-REPORTs reporting option
Values:			
0	:		status report receiving is not reported to the DTE and is not stored
1	:		the status report is sent to the DTE with the URC described in the Additional info section.
2	:		if a status report is stored, then the unsolicited result code, described in Additional info section, is sent.
<bfr>	integer	0	buffered result codes handling method
Values:			
0	:		TA buffer of unsolicited result codes defined within this command is flushed to the TE when <mode>=1..3 is entered (OK response shall be given before flushing the codes)
1	:		TA buffer of unsolicited result codes defined within this command is cleared when <mode>=1..3 is entered.

Additional info:

▶▶ **<mt>=1:**

+CMTI: <mems>,<index>

▶▶ **<mt>=2:**

PDU mode

+CMT: <alpha>,<length><CR><LF><PDU>

TEXT mode

+CMT:<oa>,<alpha>,<scts>[,<tooa>,<fo>,<pid>,<dcs>,<sca>,<tosca>,<length>]<CR><LF><data>

The parameters written in italics will be present depending on **+CSDH** last setting.

Class 2 messages and messages in the message waiting indication group (stored message) result in indication as defined in **<mt>=1**.

Acknowledge for the received SMS-DELIVER SM is sent to network immediately when **+CSMS <service>** is set to '0' or when **+CSMS <service>** is set to '1', acknowledge is sent via **+CNMA** command during predefine time-out, an error is sent to network in case timeout expire, next **+CMT** response is depend on acknowledge of current received **+CMT** response in case **+CSMS <service>** parameter set to '1'.

▶▶ **<bm>=2:**

PDU mode

+CBM: <length><CR><LF><PDU>

Text mode

+CBM: <sn>,<mid>,<dc>,<pag>,<pags><CR><LF><data>

▶▶ <ds>=1:

PDU mode

+CDS: <length><CR><LF><PDU>

TEXT mode

+CDS: <fo>,<mr>,<ra>,<tora>,<scts>,<dt>,<st>

Acknowledge for the received SMS-STATUS-REPORT SM is sent to network immediately when **+CSMS <service>** is set to '0' or when **+CSMS <service>** is set to '1', acknowledge is sent via **+CNMA** command during pre-defined timeout, an error is sent to network in case timeout expire, next **+CDS** response is depend on acknowledge of current received **+CDS** response in case **+CSMS <service>** parameter set to '1'.

▶▶ <ds>=2:

+CDSI: <mems>,<index>

Unsolicited fields:

Name	Type	Description
<mems>	string	memory storage where the new message is stored: "SM", "ME".
<index>	integer	location on the memory where SMS is stored.
<alpha>	string	alphanumeric representation of originator/destination number corresponding to the entry found in MT phonebook; used character set should be the one selected with command +CSCS .
<lenght>	integer	PDU length
<PDU>	string	PDU message
<oa>	string	originating address, string type converted in the currently selected character set (see +CSCS)
<alpha>	string	alphanumeric representation of <oa>; used character set should be the one selected with command +CSCS .
<scts>	string	arrival time of the message to the SC
<tooa>	integer	type of number <oa>: 129 - number in national format 145 - number in international format (contains the "+")
<fo>	string	first octet of message PDU, see 3GPP TS 03.40/23.040
<pid>	string	Protocol Identifier
<dc>	string	Data Coding Scheme

<sca>	string	Service Centre address, string type, converted in the currently selected character set (see +CSCS)
<tosca>	integer	type of number <sca> : 129 - number in national format 145 - number in international format (contains the "+")
<length>	integer	text length
<data>	string	TP-User-Data <ul style="list-style-type: none"> If <dcs> indicates that GSM 03.38 default alphabet is used and <fo> indicates that GSM 03.40 TP-User-Data-Header-Indication is not set (bit 6 of <fo> is 0), each character of GSM alphabet will be converted into current TE character set (see +CSCS). If <dcs> indicates that 8-bit or UCS2 data coding scheme is used or <fo> indicates that GSM 03.40 TP-User-Data-Header-Indication is set (bit 6 of <fo> is 1), each 8-bit octet will be converted into two IRA character long hexadecimal number (e.g. octet 0x2A will be converted as two characters 0x32 0x41). <p>Class 2 messages and messages in the "store" message waiting indication group result in indication as defined in <mt>=1.</p>
<sn>	integer	message serial number
<mid>	integer	message ID
<dcs>	string	Data Coding Scheme
<pag>	integer	page number
<pags>	integer	total number of pages of the message
<data>	string	CBM Content of Message <ul style="list-style-type: none"> If <dcs> indicates that GSM 03.38 default alphabet is used, each character of GSM alphabet will be converted into current TE character set (see +CSCS) If <dcs> indicates that 8-bit or UCS2 data coding scheme is used, each 8-bit octet will be converted into two IRA character long hexadecimal number (e.g. octet 0x2A will be converted as two characters 0x32 0x41)
<mr>	integer	message reference number; 3GPP TS 23.040 TP-Message-Reference in integer format
<ra>	string	recipient address, string type, represented in the currently selected character set (see +CSCS)
<tora>	integer	type of number <ra> : 129 - number in national format 145 - number in international format (contains the "+")
<scts>	string	arrival time of the message to the SC
<dt>	string	sending time of the message
<st>	string	message status as coded in the PDU

-
-  DTR signal is ignored, hence the indication is sent even if the DTE is inactive (DTR signal is Low). In this case the unsolicited result code may be lost so if MODULE remains active while DTE is not, at DTE startup is suggested to check whether new messages have reached the device meanwhile with command **AT+CMGL=0** that lists the new messages received.
-

**AT+CNMI?**

Read command returns the current parameter settings for +CNMI command in the form:

+CNMI: <mode>,<mt>,<bm>,<ds>,<bfr>

**AT+CNMI=?**

Test command reports the supported range of values for the +CNMI command parameters



```
AT+CMGF=1
```

```
OK
```

```
AT+CNMI=1,2,0,1,0
```

```
OK
```

```
Received message from network
```

```
+CMT: "+821020955219",,"07/07/26,20:09:07+36"
```

```
TEST MESSAGE
```

3.4.11. AT+CNMA - New Message Acknowledgement

This command is used to confirm the correct reception of a new message.



3GPP TS 27.005

SIM Presence	Setting saved	Can be aborted	MAX timeout	SELINT
Not required	No	No	-	2



AT+CNMA

Execution command confirms correct reception of a new message (SMS-DELIVER or SMS-STATUS-REPORT) which is routed directly to the TE.

Acknowledge with **+CNMA** is possible only if the **+CSMS** parameter is set to 1 (**+CSMS=1**) when a **+CMT** or **+CDS** indication is shown.

If no acknowledgement is given within the network timeout (17 seconds), an **RP-ERROR** is sent to the network, the **<mt>** and **<ds>** parameters of the **+CNMI** command are then reset to zero (do not show new message indication).

If command is executed, but no acknowledgement is expected, or some other ME related error occurs, result code **+CMS ERROR: <err>** is returned.

The AT command syntax and functionalities are different between SMS PDU Mode and SMS Text Mode, as explained in Additional info sections.

Additional info:

▶▶ PDU Mode

AT+CNMA[=<n>[,<length>[<CR>PDU is given<ctrl-Z/ESC>]]]

Either positive (**RP-ACK**) or negative (**RP-ERROR**) acknowledgement to the network is possible. Parameter **<n>** defines which one will be sent. Optionally (when **<length>** is greater than zero) an acknowledgement TPDU (**SMS-DELIVER-REPORT** for **RP-ACK** or **RP-ERROR**) may be sent to the network. The entering of PDU is done similarly as specified in command Send Message **+CMGS**, except that the SMSC address field is not present.

Name	Type	Default	Description
<n>	integer	N/A	type of acknowledgement in PDU mode
Values:			
0	:	send RP-ACK without PDU (same as TEXT mode)	
1	:	send RP-ACK with optional PDU message	
2	:	send RP-ERROR with optional PDU message	
<length>	integer	-	length of the PDU message

▶▶ Text Mode

AT+CNMA

Only positive acknowledgement to network (**RP-ACK**) is possible.



AT+CNMA=?

Test command returned information are different between SMS PDU Mode and SMS Text Mode, as explained below.

Additional info:

- ▶▶ PDU Mode
Test command returns the possible range of values for the parameter <n>.

- ▶▶ Text Mode
Test command returns the **OK** result code.



-  In case that a directly routed message must be buffered in ME/TA (possible when **+CNMI** parameter <mode> equals 0 or 2) or AT interpreter remains too long in a state where result codes cannot be sent to TE (e.g. user is entering a message using **+CMGS**), acknowledgement (**RP-ACK**) is sent to the network without waiting **+CNMA** command from TE.

-  It has been necessary to take the following decision to get over any incoherence problem, due to the possibility to have contemporaneous different settings of parameter <mt> and <ds> of the **+CNMI** command in different sessions (see **#PORTCFG** and **+CMUX**): only the <mt> and <ds> setting for session "0" are considered as valid to decide if **+CNMA** acknowledgment is expected or not.



- PDU Mode

```
AT+CSMS=1
+CSMS: 1,1,1
OK
```

```
Set PDU mode.
AT+CMGF=0
OK
```

```
AT+CNMI=2,2,0,0,0
OK
```

```
Message is received from network.
+CMT: "",70
06816000585426000480980600F170110370537284...
```

```
Send positive acknowledgement to the network.
AT+CNMA=0
OK
```

```
Message is received from network.
+CMT: "",70
06816000585426000480980600F170110370537284...
```

```
Send negative acknowledgment (Unspecified error) to the network.
AT+CNMA=2,3<CR>
> 00FF00 <Ctrl-Z>
OK
```

- Text Mode

```
AT+CSMS=1
+CSMS: 1,1,1
OK
```

```
Set Text mode.
AT+CMGF=1
OK
```

```
AT+CNMI=2,2,0,0,0
OK
```

```
Message is received from network.
+CMT: "+821020955219",,"07/07/26,20:09:07+36"
TEST MESSAGE
```

```
Send positive acknowledgement to the network.
AT+CNMA
OK
```

3.4.12. AT+CMGL - List Messages

This command is used to list the messages.



3GPP TS 27.005
 3GPP TS 23.040
 3GPP TS 23.038

SIM Presence	Setting saved	Can be aborted	MAX timeout	SELINT
Required	No	No	-	2



AT+CMGL[=<stat>]

Execution command reports the list of all the messages with status value <stat> stored into <memr> message storage (<memr> is the message storage for read and delete SMS as last settings of command +CPMS).

Parameter:

Name	Type	Default	Description
<stat>	mixed	-	<stat> parameter type and the command output depend on the last settings of the +CMGF command (message format to be used). There are two modes: <ul style="list-style-type: none"> • PDU mode • Text mode See the following Additional info sections.

Additional info:

▶▶ When message format is PDU mode, the <stat> parameter is:

Name	Type	Default	Description
<stat>	integer	N/A	status value

Values:

- 0 : new message
- 1 : read message
- 2 : stored message not sent yet
- 3 : stored message already sent
- 4 : all messages

▶▶ In case of PDU mode the representation format (see +CMGF) is:

+CMGL: <index>,<stat>,<alpha>,<length><CR><LF><pdu>[<CR><LF>
 +CMGL: <index>,<stat>,<alpha>,<length><CR><LF><pdu>[...]]

Name	Type	Default	Description
<index>	integer	-	message position in the storage list.
<stat>	integer	-	message status. See the above <stat> parameter description.
<alpha>	string	-	String type alphanumeric representation of <da> or <oa>, corresponding to an entry found in the phonebook; used character set is the one selected with command +CSCS .
<length>	integer	-	PDU length in bytes
<pdu>	string	-	message in PDU format, according to 3GPP TS 23.040

►► When message format is TEXT mode, the <stat> parameter is:

Name	Type	Default	Description
<stat>	string	N/A	status value
Values:			
	"REC UNREAD"	:	new message
	"REC READ"	:	read message
	"STO UNSENT"	:	stored message not sent yet
	"STO SENT"	:	stored message already sent
	"ALL"	:	all messages

►► In case of TEXT mode, the representation format for stored messages (either sent or unsent) or received messages (either read or unread, not message delivery confirm) is:

```
+CMGL: <index>,<stat>,<oa/da>,<alpha>,<scts>[,<toa/toda>,<length>]-<CR><LF>
<data>[<CR><LF>
+CMGL: <index>,<stat>,<oa/da>,<alpha>,<scts>[,<toa/toda>,<length>]-<CR><LF>
<data>[...]]
```

The information written in italics will be present depending on **+CSDH** last setting.

Name	Type	Default	Description
<index>	integer	-	message position in the storage list.
<stat>	string	-	message status. See the above <stat> parameter description.
<oa/da>	string	-	originator/destination address, represented in the currently selected character set (see +CSCS).
<alpha>	string	-	The alphanumeric representation of <da> or <oa>, corresponding to an entry found in the phonebook; used character set is the one selected with command +CSCS .
<scts>	string	-	TP-Service Centre Time Stamp in Time String Format.

<tooa/toda>	integer	N/A	type of number <oa/da>
Values:			
129	:	number in national format	
145	:	number in international format (contains the "+")	
<length>	integer	-	text length
<data>	string	-	TP-User-Data If <dcs> indicates that 3GPP TS 23.038 default alphabet is used, each character of GSM alphabet will be converted into current TE character set (see +CSCS) If <dcs> indicates that 8-bit or UCS2 data coding scheme is used, each 8-bit octet will be converted into two IRA character long hexadecimal number (e.g. octet 0x2A will be converted as two characters 0x32 0x41) If <fo> indicates that a UDH is present each 8-bit octet will be converted into two IRA character long hexadecimal number. The <length> indicates text length in characters without UDH length.

►► In case of TEXT mode, the representation format for delivery confirm messages is:

+CMGL: <index>,<stat>,<fo>,<mr>,<ra>,<tora>,<scts>,<dt>,<st>[<CR><LF>
+CMGL: <index>,<stat>,<fo>,<mr>,<ra>,<tora>,<scts>,<dt>,<st>[...]]

Name	Type	Default	Description
<index>	integer	-	message position in the storage list.
<stat>	string	-	Message status. See the last <stat> parameter description.
<fo>	integer	-	first octet of the message PDU
<mr>	integer	-	message reference number; 3GPP TS 23.040 TP-Message-Reference in integer format
<ra>	string	-	recipient address, represented in the currently selected character set (see +CSCS)
<tora>	string	-	type of number <ra>
<scts>	string	-	arrival time of the message to the SC
<dt>	string	-	sending time of the message
<st>	integer	-	message status as coded in the PDU

i If parameter is omitted the command returns the list of SMS with "REC UNREAD" status.

-
-  The order in which the messages are reported by **+CMGL** corresponds to their position in the memory storage

 **AT+CMGL=?**
Test command returns a list of supported **<stat>s**

3.4.13. AT+CMGR - Read Message

This command is used to read a message.



3GPP TS 27.005
 3GPP TS 23.040
 3GPP TS 23.038

SIM Presence	Setting saved	Can be aborted	MAX timeout	SELINT
Required	No	No	-	2



AT+CMGR=<index>

Execution command reports the message with location value <index> from <memr> message storage (<memr> is the message storage for read and delete SMs as last settings of command +CPMS).

Parameter:

Name	Type	Default	Description
<index>	integer	-	message index. The command output depends on the last settings of command +CMGF (message format to be used). There are two modes: <ul style="list-style-type: none"> • PDU mode • Text mode

See the following Additional info sections.

Additional info:

- ▶▶ In case of PDU mode, if there is a message in location <index>, the output has the following format:

+CMGR: <stat>,<alpha>,<length><CR><LF><pdu>

Name	Type	Default	Description
<stat>	integer	N/A	status of the message
Values:			
	0	:	new message
	1	:	read message
	2	:	stored message not yet sent
	3	:	stored message already sent
<alpha>	string	-	string type alphanumeric representation of <da> or <oa>, corresponding to an entry found in the phonebook; used character set is the one selected with command +CSCS
<length>	integer	-	PDU length in bytes

<PDU>	string	-	message in PDU format, according to 3GPP TS 23.040
--------------------	--------	---	--

- In case of Text mode, if there is a received message in location **<index>**, the output has the following format (the information written in *italics* will be present depending on **+CSDH** last setting):

+CMGR:<stat>,<oa>,<alpha>,<scts>
[,<tooa>,<fo>,<pid>,<dcS>,<sca>,<tosca>,<length>]<CR><LF><data>

In case of Text mode, if there is either a sent or an unsent message in location **<index>** the output format is:

+CMGR:<stat>,<da>,<alpha>
[,<toda>,<fo>,<pid>,<dcS>,<vp>,<sca>,<tosca>,<length>]<CR><LF><data>

In case of Text mode, if there is a Message Delivery Confirm message in location **<index>** the output format is:

+CMGR: <stat>,<fo>,<mr>,<ra>,<tora>,<scts>,<dt>,<st>

Name	Type	Default	Description
<stat>	string	N/A	status of the message
	Values:		
	"REC UNREAD"	:	new received message
	"REC READ"	:	received message read
	"STO UNSENT"	:	message stored not yet sent
	"STO SENT"	:	message stored already sent
<fo>	integer	-	first octet of the message PDU
<mr>	integer	-	message reference number; 3GPP TS 23.040 TP-Message-Reference in integer format
<ra>	string	-	recipient address, represented in the currently selected character set (see +CSCS)
<tora>	string	-	type of number <ra>
<scts>	string	-	arrival time of the message to the SC
<dt>	string	-	sending time of the message
<st>	integer	-	message status as coded in the PDU
<pid>	integer	-	Protocol Identifier
<dcS>	integer	-	Data Coding Scheme
<vp>	mixed	-	Validity Period; its format depends on SMS-SUBMIT <fo> setting (see +CPMS): <ol style="list-style-type: none"> 1. Not present: if <fo> tells that Validity Period Format is not present 2. Integer: if <fo> tells that Validity Period Format is relative

			<ol style="list-style-type: none"> 3. Quoted time-string type: if <fo> tells that Validity Period Format is absolute 4. Quoted hexadecimal representation of 7 octets: if <fo> tells that Validity Period Format is enhanced
<oa>	string	-	Originator address, represented in the currently selected character set (see +CSCS).
<da>	string	-	Destination address, represented in the currently selected character set (see +CSCS).
<alpha>	string	-	The alphanumeric representation of <da> or <oa> , corresponding to an entry found in the phonebook; used character set is the one selected with command +CSCS .
<sca>	string	-	Service Centre Address
<toa>	integer	N/A	type of number of <oa>
	Values:		
	129	:	number in national format
	145	:	number in international format (contains the "+")
<toda>	integer	N/A	type of number of <da>
	Values:		
	129	:	number in national format
	145	:	number in international format (contains the "+")
<tosca>	integer	N/A	type of number of <sca>
	Values:		
	129	:	number in national format
	145	:	number in international format (contains the "+")
<length>	integer	-	text length
<data>	string	-	<p>TP-User-Data</p> <p>If <dcS> indicates that 3GPP TS 23.038 default alphabet is used, each character of GSM alphabet will be converted into current TE character set (see +CSCS)</p> <p>If <dcS> indicates that 8-bit or UCS2 data coding scheme is used, each 8-bit octet will be converted into two IRA character long hexadecimal number (e.g. octet 0x2A will be converted as two characters 0x32 0x41)</p> <p>If <fo> indicates that a UDH is present each 8-bit octet will be converted into two IRA character long hexadecimal number. The <length> indicates text length in characters without UDH length.</p>

 Both in PDU and Text Mode, if status of the message was 'received unread' before reading, then status in the storage changes to 'received read'



AT+CMGR=?

Test command returns the **OK** result code

3.4.14. AT+CMGS - Send Short Message

The command is related to sending short messages.



3GPP TS 27.005
3GPP TS 23.040
3GPP TS 23.038

SIM Presence	Setting saved	Can be aborted	MAX timeout	SELINT
Required	Auto	No	-	2



AT+CMGS

Execution command sends a short message to the network. It can have two syntax formats according to the SMS format: PDU or Text mode (see **+CMGF** command). If short message is successfully sent to the network, the result is shown with the following URC:

+CMGS: <mr>[,<scts>]

Additional info:

- ▶▶ In PDU mode the **+CMGS** command has the following syntax:

AT+CMGS=<length>

After command line is terminated with <CR>, the module responds sending a four-character sequence prompt:

<CR><LF><greater_than><space> (IRA 13, 10, 62, 32)

and waits for the specified number of bytes. the PDU shall be hexadecimal format (each octet of the PDU is given as two IRA character long hexadecimal number) and given in one line.

To send the message issue Ctrl-Z char (0x1A hex). To exit without sending the message issue ESC char (0x1B hex).

Name	Type	Default	Description
<length>	integer	N/A	length in bytes of the PDU to be sent (excluding the SMSC address octets)

Value:

7÷164 : number of bytes

- ▶▶ In Text mode the **+CMGS** command has the following syntax:

AT+CMGS=<da>[,<toda>]

After command line is terminated with <CR>, the module responds sending a four-character sequence prompt:

<CR><LF><greater_than><space> (IRA 13, 10, 62, 32)

After this prompt, you can enter text that should be formatted as follows:

- if current **<dcs>** (see **+CSMP**) indicates that GSM03.38 default alphabet is used and current **<fo>** (see **+CSMP**) indicates that 3GPP TS 23.040 TP-User-Data-Header-Indication is not set, then ME/TA converts the entered text into GSM alphabet, according to 3GPP TS 27.005, Annex A; backspace can be used to delete last character and carriage returns can be used; after every **<CR>** entered by the user the sequence **<CR><LF><greater_than><space>** is sent to the TE.
- if current **<dcs>** (see **+CSMP**) indicates that 8-bit or UCS2 data coding scheme is used or current **<fo>** (see **+CSMP**) indicates that 3GPP TS 23.040 TP-User-Data-Header-Indication is set, the entered text should consist of two IRA character long hexadecimal numbers which ME/TA converts into 8-bit octet (e.g. the 'asterisk' will be entered as 2A (IRA50 and IRA65) and this will be converted to an octet with integer value 0x2A)

To send the message issue Ctrl-Z char (0x1A hex). To exit without sending the message issue ESC char (0x1B hex).

Name	Type	Default	Description
<da>	string	-	destination address, string type represented in the currently selected character set (see +CSCS).
<toda>	string	129	type of destination address

Values:

129 : number in national format

145 : number in international format (contains the "+")

Unsolicited fields:

Name	Type	Description
<mr>	integer	TP-Message-Reference number as per 3GPP TS 23.040
<scts>	string	TP-Service Centre Time Stamp in Time String Format. <scts> is returned when +CSMS <service> value is 1 and network supports.

- i** The DCD signal shall be in **ON** state while data is entered. The echoing of data is controlled by echo command **E**.
- i** in PDU mode: when the length of the SMSC address equals 0, then the SMSC address set with command **+CSCA** is used; in this case the SMSC Type of Address octet shall not be present in the data.
- i** To ensure that during the command execution, which may take several seconds, no other SIM interacting commands issued, care must take.

i It is possible to send a concatenation of at most 10 SMS; the maximum number of chars depends on the **<dc>**:

- 2448 chars
- 2144 chars if 8-bit is used
- 1072 chars if UCS2 is used

i If message sending fails for some reason, then an error code is reported.



AT+CMGS=?

Test command returns the **OK** result code.

i To avoid malfunctions is suggested to wait for the **+CMGS: <mr>** or **+CMS ERROR: <err>** response before issuing further commands.



To avoid malfunctions it is suggested to wait for the **+CMGS: <mr>** or **+CMS ERROR: <err>** response before issuing further commands.



Set PDU mode

AT+CMGF=0

AT+CMGS=18

> 088128010099010259115507811020905512F90000A704F4F29C0E

+CMGS: 124

OK

Set text mode

AT+CMGF=1

AT+CSMP=17,167,0,0

AT+CMGS="01090255219",129

>TEST MESSAGE

+CMGS:125

OK

3.4.15. AT+CMGW - Write Short Message to Memory

The command is related to writing short messages.



3GPP TS 27.005
3GPP TS 23.040
3GPP TS 23.038

SIM Presence	Setting saved	Can be aborted	MAX timeout	SELINT
Required	Auto	No	-	2



AT+CMGW

Execution command writes a new short message in the **<memw>** memory storage (see **+CPMS**). It can have two syntax formats according to the SMS format: PDU or Text mode (see **+CMGF** command). If short message is successfully written the following URC is displayed:

+CMGW: <index>

Additional info:

- ▶▶ In PDU mode the **+CMGW** command has the following syntax:

AT+CMGW=<length>[,<stat>]

After command line is terminated with <CR>, the module responds sending a four-character sequence prompt:

<CR><LF><greater_than><space> (IRA 13, 10, 62, 32)

and waits for the specified number of bytes.

To write the message issue Ctrl-Z char (0x1A hex). To exit without sending the message issue ESC char (0x1B hex).

Name	Type	Default	Description
<length>	integer	N/A	length in bytes of the PDU to be written
Value:			
7÷164 : number of bytes			
<stat>	integer	N/A	message status
Values:			
0 : new message new message (received unread message; default for DELIVER messages (3GPP TS 23.040 SMS-DELIVER messages))			
1 : read message			
2 : stored message not sent yet (default for SUBMIT messages (3GPP TS 23.040 SMS-SUBMIT messages))			
3 : stored message already sent			

<data>	hex	-	PDU bytes, given in online mode
---------------------	-----	---	---------------------------------

►► In Text mode the **+CMGW** command has the following syntax:

AT+CMGW[=<da>[,<toda>[,<stat>]]]

After command line is terminated with <CR>, the module responds sending a four-character sequence prompt:

<CR><LF><greater_than><space> (IRA 13, 10, 62, 32)

After this prompt, you can enter text that should be formatted as follows:

- if current **<dcs>** (see **+CSMP**) indicates that GSM03.38/23.038 default alphabet is used and current **<fo>** (see **+CSMP**) indicates that 3GPP TS 03.40/23.040 TP-User-Data-Header-Indication is not set, then ME/TA converts the entered text into GSM alphabet, according to 3GPP TS 27.005, Annex A; backspace can be used to delete last character and carriage returns can be used..
- if current **<dcs>** (see **+CSMP**) indicates that 8-bit or UCS2 data coding scheme is used or current **<fo>** (see **+CSMP**) indicates that 3GPP TS 23.040 TP-User-Data-Header-Indication is set, the entered text should consist of two IRA character long hexadecimal numbers which ME/TA converts into 8-bit octet (e.g. the 'asterisk' will be entered as 2A (IRA50 and IRA65) and this will be converted to an octet with integer value 0x2A)





The command waits for the specified number of bytes.

To write the message issue Ctrl-Z char (0x1A hex). To exit without writing the message issue ESC char (0x1B hex).

Name	Type	Default	Description
<da>	string	-	destination address, string type represented in the currently selected character set (see +CSCS).
<toda>	integer	N/A	type of destination address
Values:			
129	:	number in national format	
145	:	number in international format (contains the character "+")	
<stat>	string	N/A	message status
Values:			
"REC UNREAD"	:	new received message unread	
"REC READ"	:	received message read	
"STO UNSENT"	:	message stored not yet sent (default)	
"STO SENT"	:	message stored already sent	

Unsolicited field:

Name	Type	Description
<index>	integer	message location index in the memory <memw> (see +CPMS). If message storing fails for some reason, an error code is reported.

-  The DCD signal shall be in **ON** state while <data> is entered. The echoing of <data> is controlled by echo command **E**.
-  In PDU mode, not only SUBMIT messages can be stored in SIM, but also DELIVER and STATUS REPORT messages (3GPP TS 23.040 SMS-STATUS-REPORT messages). SUBMIT messages can only be stored with status 2 or 3; DELIVER and STATUS REPORT messages can only be stored with status 0 or 1.
-  Care must be taken to ensure that during the command execution, which may take several seconds, no other SIM interacting commands are issued.
-  It is possible to save a concatenation of at most 10 SMS; the maximum number of chars depends on <dc>:
 - 2448 chars
 - 2144 chars if 8-bit is used
 - 1072 chars if UCS2 is used
-  In text mode, not only SUBMIT messages can be stored in SIM, but also DELIVER messages.

The type of saved message depends upon the current <fo> parameter (see **+CSMP**). For a DELIVER message, current <vp> parameter (see **+CSMP**) is used to set the message Service Centre Time Stamp <scts>, so it must be an absolute time string, e.g. "09/01/12,11:15:00+04".

SUBMIT messages can only be stored with status "STO UNSENT" or "STO SENT"; DELIVER messages can only be stored with status "REC UNREAD" or "REC READ".

-  If message writing fails for some reason, then an error code is reported.



AT+CMGW=?

Test command returns the **OK** result code.



To avoid malfunctions it is suggested to wait for the **+CMGW: <index>** or **+CMS ERROR: <err>** response before issuing further commands.



AT+CMGF=0 set PDU mode
OK

AT+CMGW=18
> 088128010099010259115507811020905512F90000A704F4F29C0E
+CMGW: 29
OK

AT+CMGF=1 set text mode
OK

AT+CSMP=17,167,0,0
OK

AT+CSCA="821029190903",145
OK

AT+CMGW="0165872928"
> test message...
+CMGW: 28

3.4.16. AT+CMGD - Delete Message

This command allows to delete from memory messages.



3GPP TS 27.005

SIM Presence	Setting saved	Can be aborted	MAX timeout	SELINT
Required	No	No	-	2



AT+CMGD=<index>[,<delflag>]

Execution command deletes SMS message(s) from a selected memory storage. Storage is selected by command **+CPMS**.

Parameters:

Name	Type	Default	Description
<index>	integer	-	Message index in the selected storage; it can have values from 1 to N, where N depends on the available space in the selected storage (see +CPMS)
<delflag>	integer	0	Type of multiple message deletion

Values:

- 0 : delete message specified in <index>
- 1 : delete all read messages from selected storage, leaving unread messages and stored mobile originated messages (whether sent or not) untouched
- 2 : delete all read messages from selected storage and sent mobile originated messages, leaving unread messages and unsent mobile originated messages untouched
- 3 : delete all read messages from selected storage, sent and unsent mobile originated messages, leaving unread messages untouched
- 4 : delete all messages from selected storage.

- i** If <delflag> is present and not set to 0 then, if <index> is greater than 0, <index> is ignored and the command follows the rules for <delflag> shown above.



AT+CMGD=?

Test command shows the valid memory locations <index> and the supported values of <delflag>.



```
AT+CMGD=?
+CMGD: (1,2,3,6,7,17,18,19,20,37,38,39,47),(0-4)
OK
```

3.4.17. AT+CGSMS - Select Service for MO SMS Messages

Set command is used to specify the service or service preference that the MT will use to send MO SMS messages.



3GPP TS 27.005

SIM Presence	Setting saved	Can be aborted	MAX timeout	SELINT
Required	Auto	No	-	2



AT+CGSMS=[<service>]

Parameter:

Name	Type	Default	Description
<service>	integer	1	indicates the service or service preference to be used

Values:

- 0 : GPRS
- 1 : circuit switched
- 2 : GPRS preferred. Use circuit switched if SMS via GPRS service not available or GPRS not registered.
- 3 : circuit switched preferred. Use GPRS if SMS via circuit switched not available.



Entering **AT+CGSMS=** returns **OK** but has no effect.



AT+CGSMS?

The read command returns the currently selected service or service preference in the format:

+CGSMS: <service>



AT+CGSMS=?

Test command reports the supported list of currently available <service>.



The <service> value is saved on NVM as global parameter.

3.4.18. AT#SMSMODE - SMS Commands Operation Mode

SMS Commands Operation Mode.

SIM Presence	Setting saved	Can be aborted	MAX timeout	SELINT
Not required	Auto	No	-	2



AT#SMSMODE=<mode>

Set command enables/disables the check for presence of SMS Service Centre Address (SCA) in the Fixed Dialing Number (FDN) phonebook.

Parameter:

Name	Type	Default	Description
<mode>	integer	1	Enables/disables the check for presence of SCA in FDN phonebook.

Values:

- 1 : Disables the check for presence of SCA in FDN phonebook.
- 2 : Enables the check for presence of SMS SCA in the FDN phonebook when FDN are enabled. If the SMS SCA is not present a SMS cannot be sent.



AT#SMSMODE?

Read command reports whether the check of SMS SCA in FDN phonebook is enabled or not, in the format:

#SMSMODE: <mode>



AT#SMSMODE=?

Test command reports the range of <mode> parameter values.

3.4.19. AT#CMGLCONCINDEX - Report Concatenated SMS Indexes

The command reports list of all concatenated SMS

SIM Presence	Setting saved	Can be aborted	MAX timeout	SELINT
Required	No	No	-	2



AT#CMGLCONCINDEX

The command reports a line for each concatenated SMS containing:

#CMGLCONCINDEX: <N>,<i>,<j>,<k>,...

If no concatenated SMS is present on the SIM, only **OK** result code will be returned.

The parameters are described in the Additional info section.

Additional info:

- ▶▶ Here is the meaning of the parameters returned by the command.

Name	Type	Default	Description
<N>	integer	-	Number of segments that form the whole concatenated SMS.
<i>	integer	-	index of the first SMS segment. 0 if segment has not been received.
<j>	integer	-	index of the second SMS segment. 0 if segment has not been received.
<k>	integer	-	index of the third SMS segment 0 if segment has not been received
<...>	integer	-	index of the next SMS segment ...



AT#CMGLCONCINDEX=?

Test command returns **OK** result code.



- Example of 2 concatenated SMS:
First composed by 3 segments: 1,2,3, but segment 0 not received yet.
Secondo composed by segments: 4,5,6,7,8, but segment 7 not received yet.
AT#CMGLCONCINDEX
#CMGLCONCINDEX: 3,0,2,3
#CMGLCONCINDEX: 5,4,5,6,0,8
OK

3.4.20. AT#E2SMSRI - SMS Ring Indicator

This set command enables/disables the Ring Indicator pin response to an incoming SMS message. If enabled, a negative going pulse is generated when receiving an incoming SMS message.

SIM Presence	Setting saved	Can be aborted	MAX timeout	SELINT
Required	Common profile	No	-	2



AT#E2SMSRI=[<n>]

Parameter:

Name	Type	Default	Description
<n>	integer	0	RI enabling

Values:

- 0 : disables RI pin response for incoming SMS messages
- 50÷1150 : enables RI pin response for incoming SMS. The value of <n> is the duration in ms of the pulse generated on receipt of an incoming SMS.

- i** If **+CNMI=3,1** command is issued, and the module is in a GPRS connection, a 100 ms break signal is sent and a 1 sec. pulse is generated on RI pin, no matter if the RI pin response is either enabled or not.



AT#E2SMSRI?

Read command reports the duration in ms of the pulse generated on receipt of an SMS, in the format:

#E2SMSRI: <n>

- i** **<n>=0** means that the RI pin response to an incoming SMS is disabled



AT#E2SMSRI=?

Reports the range of supported values for parameter <n>

3.4.21. AT#SMOV - SMS Overflow

The command is used to enable the SMS overflow signaling functionality.

SIM Presence	Setting saved	Can be aborted	MAX timeout	SELINT
Required	Specific profile	No	-	2



AT#SMOV=[<mode>]

Set command enables the SMS overflow signaling function. If enabled, URC code is:

#SMOV: <memo>

Parameter:

Name	Type	Default	Description
<mode>	integer	0	signaling functionality mode

Values:

- 0 : disables SMS overflow signaling function
- 1 : enables SMS overflow signaling function

Unsolicited field:

Name	Type	Description
<memo>	string	<memo> is a string indicating the SMS storage that has reached the maximum capacity

Values:

- "SM" : SIM Memory
- "ME" : NVM SMS Storage



When the maximum storage capacity has been reached, if enabled, a network-initiated notification is sent.



AT#SMOV?

Read command reports whether the SMS overflow signaling function is currently enabled or not, in the format:

#SMOV: <mode>



AT#SMOV=?

Test command returns the supported range of values of parameter <mode>.

3.4.22. AT#SMSMOVE - Move Short Message to other Memory

This command moves selected Short Message from current memory to destination memory.

SIM Presence	Setting saved	Can be aborted	MAX timeout	SELINT
Required	Auto	No	-	2



AT#SMSMOVE=<index>

Execution command moves selected Short Message from current memory to destination memory.

Parameter:

Name	Type	Default	Description
<index>	string	-	message index in the memory selected by +CPMS command. It can have values form 1 to N, where N depends on the available space, see +CPMS .

If the destination memory is full, an error is returned



AT#SMSMOVE?

Read command reports the message storage status of the current memory and the destination memory in the format:

#SMSMOVE:<curr_mem>,<used_curr_mem>,<total_curr_mem>,<dest_mem>,<used_dest_mem>,<total_dest_mem>

Additional info:

▶▶ Parameters:

Name	Type	Default	Description
<curr_mem>	string	N/A	current memory, selected by +CPMS command
Values:			
SM	:		SIM SMS memory storage
ME	:		NVM SMS storage
<used_curr_mem>	integer	-	number of SMS stored in the current memory
<total_curr_mem>	integer	-	max number of SMS that the current memory can contain
<dest_mem>	string	SM	destination memory
Values:			
SM	:		SIM memory
ME	:		device memory

<used_dest_mem>	integer	-	number of SMS stored in the destination memory
<total_dest_mem>	integer	-	max number of SMS that the destination memory can contain

**AT#SMSMOVE=?**

Test command reports the supported values for parameter **<index>**

**AT#SMSMOVE?**

```
#SMSMOVE: "ME",3,100,"SM",0,50
```

OK

The current memory is ME where 3 SMS are stored; the destination memory is SIM that is empty

```
AT+CMGL=ALL
```

```
+CMGL: 1,"STO UNSENT","32XXXXXXXXX","",
```

Test 1

```
+CMGL: 2,"STO UNSENT","32XXXXXXXXX","",
```

Test 2

```
+CMGL: 3,"STO UNSENT","32XXXXXXXXX","",
```

Test 3

OK

List the SMS to discover the memory index

```
AT#SMSMOVE=1
```

OK

Move the SM in the first position of ME to SIM

```
AT#SMSMOVE?
```

```
#SMSMOVE: "ME",2,100,"SM",1,50
```

OK

Now we have 2 SMS in ME and 1 in SIM

3.5. Phonebook

3.5.1. AT+CPBS - Select Phonebook Memory Storage

This set command selects phonebook memory storage, which will be used by other phonebook commands.



3GPP TS 27.007

SIM Presence	Setting saved	Can be aborted	MAX timeout	SELINT
Required	Specific profile	No	-	2



AT+CPBS=<storage>[,<password>]

Parameters:

Name	Type	Default	Description
<storage>	string	"SM"	specify the phonebook memory storage
Values:			
"SM"	:	SIM phonebook	
"FD"	:	SIM fixed dialing-phonebook (FDN)(only phase 2/2+ SIM)	
"LD"	:	SIM last-dialing-phonebook (+CPBF is not applicable for this storage)	
"MC"	:	device missed (unanswered received) calls list (+CPBF is not applicable for this storage)	
"RC"	:	ME received calls list (+CPBF is not applicable for this storage)	
"MB"	:	mailbox numbers stored on SIM; it is possible to select this storage only if the mailbox service is provided by the SIM (see #MBN)	
"DC"	:	ME last-dialing-phonebook (+CPBF is not applicable for this storage)	
"ME"	:	ME phonebook	
"EN"	:	SIM emergency numbers phonebook (+CPBW and +CPBF not applicable for this storage)	
"ON"	:	SIM own numbers (MSISDNs) phonebook (+CPBF is not applicable for this storage)	
"SD"	:	SIM Service Dialing Numbers (SDN) phonebook (+CPBW is not applicable for this storage)	
<password>	string	-	string type value representing the PIN2-code required when selecting PIN2-code locked <storage> above "FD". if <password> parameter is given, PIN2 will be verified, even if it is not required, i.e. PIN2 is verified even if it has already been inserted and verified during current session.

- i** If "SM" is the currently selected phonebook, selecting "FD" phonebook with **AT+CPBS="FD"** command simply selects the FDN as the phonebook upon which all subsequent **+CPBW**, **+CPBF** and **+CPBR** commands act. The command does not deactivate "SM" phonebook, and does not activate FDN.

**AT+CPBS?**

Read command returns the actual values of the parameter **<storage>**, the number of occupied records **<used>** and the maximum index number **<total>**, in the format:

+CPBS: <storage>,<used>,<total>

-  For **<storage>="MC"**: if there are more than one missed calls from the same number the read command will return only the last call.

**AT+CPBS=?**

Test command returns the supported range of values for the parameter **<storage>**

3.5.2. AT+CPBR - Read Phonebook Entries

The command reads phonebook entries.



3GPP TS 27.007

SIM Presence	Setting saved	Can be aborted	MAX timeout	SELINT
Required	No	No	-	2



AT+CPBR=<index1>[,<index2>]

Execution command returns phonebook entries in location number range <index1>..<index2> from the current phonebook memory storage selected with **+CPBS**. If <index2> is omitted, only location <index1> is returned.

The intermediate response format is:

```
[+CPBR:<index1>,<number>,<type>,<text>[,<hidden>]][,<group>]
[,<adnumber>][,<adtype>][,<secondtext>][,<email>]]
```

...

```
[<CR><LF> +CPBR:<index2>,<number>,<type>,<text>[,<hidden>]
[,<group>][,<adnumber>] [,<adtype>][,<secondtext>][,<email>]]]
```

Parameters:

Name	Type	Default	Description
<index1>	integer	-	value in the range of location numbers of the currently selected phonebook memory storage (see +CPBS).
<index2>	integer	-	value in the range of location numbers of the currently selected phonebook memory storage (see +CPBS).

Additional info:

►► Intermediate response parameters

Name	Type	Default	Description
<indexn>	integer	-	the location number of the phonebook entry
<number>	string	-	phone number of format <type>
<type>	integer	N/A	type of phone number octet
Values:			
	129	:	national numbering scheme
	145	:	international numbering scheme (contains the character "+")
<test>	string	-	the alphanumeric text associated to the number; character set as specified by command Select TE Character Set +CSCS
<hidden>	integer	0	indicates if the entry is hidden or not

Values:

- 0 : phonebook entry not hidden
- 1 : phonebook entry hidden

<group>	string	-	the group the entry may belong to; character set as specified by command Select TE Character Set +CSCS
<adnumber>	string	-	additional phone number of format <adtype>
<adtype>	integer	-	type of address octet
<secondtext>	string	-	second text field associated with the number; character set as specified by command Select TE Character Set +CSCS
<email>	string	-	email address; character set as specified by command Select TE Character Set +CSCS

- i** If "MC" is the currently selected phonebook memory storage, a sequence of missed calls coming from the same number will be saved as one missed call and **+CPBR** will show just one line of information.
- i** If all queried locations are empty (but available), no information text lines will be returned, while if listing fails in an ME error, **+CME ERROR: <err>** is returned.



AT+CPBR=?

Test command returns the supported range of values for parameters **<indexn>** and the maximum lengths of **<number>**, **<text>**, **<group>**, **<secondtext>** and **<email>** string parameters, in the format:

+CPBR: (<minIndex> - <maxIndex>),<nlength>,<tlength>,<glength>,<slength>,<elength>

Additional info:

- ▶▶ Test command response parameters

Name	Type	Default	Description
<minIndex>	integer	-	the minimum <index> number
<maxIndex>	integer	-	the maximum <index> number
<nlength>	integer	-	maximum <number> field length
<tlength>	integer	-	maximum <name> field length
<glength>	integer	-	maximum <group> field length
<slength>	integer	-	maximum <secondtext> field length
<elength>	integer	-	maximum <email> field length

-
-  The value of **<nlength>** could vary, depending on the availability of Extension service, in the following situations:
1. if "SM" memory storage has been selected (see **+CPBS**) and the SIM supports the Extension1 service
 2. if "FD" memory storage has been selected (see **+CPBS**) and the SIM supports the Extension2 service
 3. if "MB" memory storage has been selected (see **+CPBS**) and the SIM supports the Extension6 service
-



-  Remember to select the PB storage with **+CPBS** command before issuing PB commands.

3.5.3. AT+CPBF - Find Phonebook Entries

This command returns phonebook entries.



3GPP TS 27.007

SIM Presence	Setting saved	Can be aborted	MAX timeout	SELINT
Required	Other	No	-	2



AT+CPBF=<findtext>

Execution command returns phonebook entries (from the current phonebook memory storage selected with **+CPBS**) which alphanumeric field start with string **<findtext>**.

Parameter:

Name	Type	Default	Description
<findtext>	string	-	string to be searched among the phonebook entries; used character set should be the one selected with command +CSCS .

Additional info:

►► The command returns a report in the form:

```
[+CPBF:<index1>,<number>,<type>,<text>[,<hidden>][,<group>][,<adnumber>]
[,<adtype>][,<secondtext>][,<email>]<CR><LF>
+CPBF:<index2>,<number>,<type>,<text>[,<hidden>][,<group>][,<adnumber>]
[,<adtype>][,<secondtext>][,<email>][...]]
```

Name	Type	Default	Description
<indexn>	integer	-	The location number of the phonebook entry
<number>	string	-	Phone number of format <type>
<type>	integer	N/A	type of phone number octet
Values:			
	129	:	national numbering scheme
	145	:	international numbering scheme (contains the character "+")
<text>	string	-	The alphanumeric text associated to the number; the character set used should be the one selected with command +CSCS
<group>	string	-	Field of maximum length <glength> indicating a group the entry may belong to; character set as specified by command Select TE Character Set +CSCS
<adnumber>	string	-	additional number; phone number of format <adtype>
<adtype>	integer	-	type of address octet

<secondtext>	string	-	Field of maximum length <slength> indicating a second text field associated with the number; character set as specified by command Select TE Character Set +CSCS
<email>	string	-	field of maximum length <elength> indicating an email address; character set as specified by command Select TE Character Set +CSCS
<hidden>	string	N/A	indicates if the entry is hidden or not

Values:

- 0 : phonebook entry not hidden
- 1 : phonebook entry hidden

- i** **+CPBF** is not applicable if the current selected storage (see **+CPBS**) is either "MC", "RC" or "LD".
- i** If **<findtext>=""** the command returns all the phonebook records.
- i** If no PB records satisfy the search criteria then an **ERROR** message is reported.



AT+CPBF=?

Test command reports the maximum lengths of **<number>** and **<text>** fields, in the format:

+CPBF: <nlength>,<tlength>,<glength>,<slength>,<elength>

Additional info:

▶▶ Test command response fields

Name	Type	Default	Description
<nlength>	integer	-	Maximum length of field <number>
<tlength>	integer	-	Maximum length of field <text>
<glength>	integer	-	Maximum length of field <group>
<slength>	integer	-	Maximum length of field <secondtext>
<elength>	integer	-	Maximum length of field <email>

- i** The value of **<nlength>** could vary, depending on the availability of Extension service, in the following situations:
 1. if "SM" memory storage has been selected (see **+CPBS**) and the SIM supports the **Extension1** service
 2. if "FD" memory storage has been selected (see **+CPBS**) and the SIM supports the **Extension2** service
 3. if "MB" memory storage has been selected (see **+CPBS**) and the SIM supports the **Extension6** service



Remember to select the PB storage with **+CPBS** command before issuing PB commands.

3.5.4. AT+CPBW - Write Phonebook Entry

This command writes phonebook entry in the current phonebook memory.



3GPP TS 27.007

SIM Presence	Setting saved	Can be aborted	MAX timeout	SELINT
Required	Other	No	-	2



AT+CPBW=[<index>][,<number>[,<type>[,<text>[,<group>[,<adnumber>[,<adtype>[,<secondtext>[,<email>[,<hidden>]]]]]]]]]

Execution command writes phonebook entry in location number <index> in the current phonebook memory storage selected with **+CPBS**.

Parameters:

Name	Type	Default	Description
<index>	integer	-	value in the range of location numbers of the currently selected phonebook memory storage (see +CPBS)
<number>	string	-	phone number in the format <type>
<type>	integer	129	type of number
Values:			
	129	:	national numbering scheme
	145	:	international numbering scheme (contains the character "+")
<text>	string	-	text associated to the number; used character set should be the one selected with command +CSCS
<group>	string	-	string type field of maximum length <glength> indicating a group the entry may belong to; character set as specified by command Select TE Character Set +CSCS
<adnumber>	string	-	additional number; string type phone number of format <adtype>
<adtype>	integer	-	type of address octet
<secondtext>	string	-	string type field of maximum length <slength> indicating a second text field associated with the number; character set as specified by command Select TE Character Set +CSCS
<email>	string	-	field of maximum length <elength> indicating an email address; character set as specified by command Select TE Character Set +CSCS
<hidden>	integer	0	indicates if the entry is hidden or not
Values:			
	0	:	phonebook entry not hidden
	1	:	phonebook entry hidden



If record number <index> already exists, it will be overwritten.

- i** If either **<number>**, **<type>** and **<text>** are omitted, the phonebook entry in location **<index>** is deleted.
- i** If either "LD", "MC" or "RC" memory storage has been selected (see **+CPBS**) it is possible just to delete the phonebook entry in location **<index>**, therefore parameters **<number>**, **<type>** and **<text>** must be omitted.
- i** Before defining **<group>** string, it is recommended to check, with **#CPBGR** command, the predefined group names, that could be already stored in USIM in Grouping information Alpha String (GAS) file. If all records in such file are already occupied, **+CPBW** command will return ERROR when trying to use a new group name that is not in the predefined GAS names. To define a new custom group string, it is necessary to overwrite with it one of the old predefined strings, using **#CPBGW** command.

? AT+CPBW=?

Test command returns location range supported by the current storage as a compound value, the maximum length of **<number>** field, supported number format of the storage and maximum length of **<text>** field. The format is:

+CPBW: (list of supported **<index>s**),**<nlength>**,(list of supported **<type>s**),**<tlength>**,**<glength>**,**<slength>**,**<elength>**

Additional info:

▶▶ Test command response fields

Name	Type	Default	Description
<nlength>	integer	-	Maximum length of field <number>
<tlength>	integer	-	Maximum length of field <text>
<glength>	integer	-	Maximum length of field <group>
<slength>	integer	-	Maximum length of field <secondtext>
<elength>	integer	-	Maximum length of field <email>

- i** the value of **<nlength>** could vary, depending on the availability of Extension service, in the following situations:
 1. if "SM" memory storage has been selected (see **+CPBS**) and the SIM supports the **Extension1** service
 2. if "FD" memory storage has been selected (see **+CPBS**) and the SIM supports the **Extension2** service
 3. if "MB" memory storage has been selected (see **+CPBS**) and the SIM supports the **Extension6** service



Remember to select the PB storage with **+CPBS** command before issuing PB commands.



if **<index>** is omitted or **<index>=0**, the number **<number>** is stored in the first free phonebook location.

```
AT+CPBW=0,"+39040X192YZ1",129,"Text"
```

```
AT+CPBW=,"+39040X192YZ1",129,"Text"
```

3.5.5. AT#CPBGR - Read Group Entries

This command returns Grouping information Alpha String (GAS) USIM file entries.

SIM Presence	Setting saved	Can be aborted	MAX timeout	SELINT
Required	No	No	-	2



AT#CPBGR=<indexFirst>[,<indexLast>]

Set command returns Grouping information Alpha String (GAS) USIM file entries in location number range <indexFirst>...<indexLast>. If <indexLast> is omitted, only location <indexFirst> is returned. The response, for each location, is a string. This string is a name used for a group the ADN entries can belong to.

The response format is:

```
[#CPBGR: <index1>,<text1>[<CR><LF>
#CPBGR: <index2>,<text2>[...]]]
```

Parameters:

Name	Type	Default	Description
<indexFirst>	integer	NA	first location to be read
Value:			
minIndex÷maxIndex		:	range of location numbers of GAS, where "minIndex" and "maxIndex" can be obtained by issuing the test command
<indexLast>	integer	NA	last location to be read
Value:			
minIndex÷maxIndex		:	range of location numbers of GAS, where "minIndex" and "maxIndex" can be obtained by issuing the test command

Additional info:

▶▶ Response parameters:

Name	Type	Default	Description
<index>	integer	N/A	location number of the GAS entry
Value:			
indexFirst÷indexLast		:	range of location numbers of GAS returned in the response
<text>	string	-	alphanumeric text associated to the entry



AT#CPBGR=?

Test command returns the supported values of the parameters <index_n> and the maximum length of <text_n> field, in the format:

#CPBGR: (<minIndex> - <maxIndex>),<tlength>

Additional info:

▶▶ Parameters:

Name	Type	Default	Description
<minIndex>	integer	-	minimum <index> number
<maxIndex>	integer	-	maximum <index> number
<tlength>	integer	-	maximum <text> field length

3.5.6. AT#CPBGW - Write Group Entry

Set command writes the name of a phonebook group <text> in the Grouping information Alpha String (GAS) USIM file in a specified location number <index>.

SIM Presence	Setting saved	Can be aborted	MAX timeout	SELINT
Required	No	No	-	2



AT#CPBGW=<index>,<text>

Parameters:

Name	Type	Default	Description
<index>	integer	-	number of the record in the GAS file to be written; value ranges from 1 to the number of records of the GAS file, that varies from USIM to USIM
<text>	string	-	text to be stored in the record

 If record number <index> already exists, it will be overwritten



AT#CPBGW=?

Test command returns location range supported by the current storage as a compound value, and maximum length of <text> field. The format is:

+CPBGW: (list of supported <index>s),<tlength>

Additional info:

▶▶ Parameter:

Name	Type	Default	Description
<tlength>	integer	-	maximum length of field <text> in bytes; actual maximum number of characters that can be stored depends upon <text> coding (see +CSCS)

3.5.7. AT#CPBD - Delete All Phonebook Entries

This command deletes all phonebook entries.

SIM Presence	Setting saved	Can be aborted	MAX timeout	SELINT
Required	Auto	No	-	2



AT#CPBD

This execution command deletes all phonebook entries in the current phonebook memory storage selected with **+CPBS**.



AT#CPBD=?

Test command returns **OK** result code.

3.6. Jamming Detection and Report

3.6.1. AT#JDRENH2 - Enhanced Jamming Detection and Report

This command enables/disable jamming detection, and reports the relative result to the user.



[1] Hardware User's Guide of the used module

SIM Presence	Setting saved	Can be aborted	MAX timeout	SELINT
Required	Auto	No	-	2



AT#JDRENH2=<mode>[,<sat2G>,<unused>,<carrNum2G>,<pRxLevT2G>,<unused>,<unused>,<unused>[,<P_RSSI_T4G>[,<P_RSRQ_T4G>[,<unused>]]]]

The set command performs the following activities:

- enables/disables the detection of the presence of jamming in the module coverage.
- selects one of the following two reports mode or both: on dedicated GPIO, by means of the URC, or GPIO + URC.

Parameters:

Name	Type	Default	Description
<mode>	integer	0	enable/disable jamming detection and select reporting mode
Values:			
0	:	disable jamming detection	
1	:	enable jamming detection, and report its condition on a GPIO pin, see Additional info section	
2	:	enable jamming detection, and report its condition with an URC, see Additional info section	
3	:	enable jamming detection, and report its condition as <mode>=1 and <mode>=2	
4	:	enable jamming detection, and report its condition with an URC every 3 sec, see <mode>=2	
5	:	enable jamming detection, and report its condition as <mode>=1 and <mode>=4	
6	:	not used	
<sat2G>	integer	45	is the starting absolute threshold of RSSI 2G Network. After a frequency scan in 2G bands, if the measured power of a carrier is greater than <sat2G> threshold, that carrier is counted as possible jammed carrier.
Value:			
0÷63	:	threshold values	
<unused>	integer	N/A	unused parameter
Value:			

		0	: dummy value
<carrNum2G>	integer	100	is the minimum number of possible jammed carriers to consider that the module is under jamming condition
	Value:		
		0÷200	: number of carriers
<pRxLev2G>	integer	15	set the threshold of RxLev in 2G Network. The RxLev_Thr threshold is calculated as shown below: $\text{RxLev_Thr} = \text{RxLev_Av} * (1 + (\text{<pRxLev2G>/100}))$ where RxLev_Av is the average of the last 10 RxLev measures.
	Value:		
		0÷100	: values used to compute RxLev_Thr threshold
<unused>	integer	N/A	unused parameter
	Value:		
		0	: dummy value
<unused>	integer	N/A	unused parameter
	Value:		
		0	: dummy value
<unused>	integer	N/A	unused parameter
	Value:		
		0	: dummy value
<P_RSSI_T4G>	integer	20	Set the threshold of RSSI. The threshold (T_RSSI_MAX/T_RSSI_MIN) is calculated as: $\text{T_RSSI_MAX} = \text{RSSI_Avg} * (1 + (\text{<P_RSSI_T4G>/100}))$ $\text{T_RSSI_MIN} = \text{RSSI_Avg} * (1 - (\text{<P_RSSI_T4G>/100}))$ where RSSI_Avg is the average of the last 50 RSSI measures.
	Value:		
		0÷100	: RSSI threshold values
<P_RSRQ_T4G>	integer	20	Set the threshold of RSRQ. The threshold (RSRQ_Thr) is calculated as $\text{RSRQ_Thr} = \text{RSRQ_Avg} * (1 - (\text{<P_RSRQ_T4G>/100}))$ where RSRQ_Avg is the average of the last 50 RSRQ measures.
	Value:		
		0÷100	: RSRQ threshold values
<unused>	integer	0	unused parameter

Value:

0 : dummy value

Additional info:

▶▶ **<mode>=1**

The jamming condition is reported on pin GPIO_02 (JDR):

- GPIO_02 (JDR) = Low, Normal Operating Condition
- GPIO_02 (JDR) = High, Jammed Condition

To have information on GPIO_02 pin, refer to document [1]. GPIO_02 pin can be used also by other functionality, see **#GPIO** command.

▶▶ **<mode>=2**

the jamming condition is reported with a single URC on serial line, in the format:

#JDR: <status>

Unsolicited field:

Name	Type	Description
<status>	string	jamming condition status, <mode>=2

Values:

JAMMED RAT	:	jamming condition detected, <RAT> is the Radio Access Technology for operates: GSM or LTE.
OPERATIVE RAT	:	Normal Operating condition restored. Status shown only after a jamming condition has occurred.



AT#JDRENH2?

Read command reports the current parameters values, in the format:

#JDRENH2:<mode>,<sat2G>,0,<carrNum2G>,<pRxLevT2G>,0,0,0,<P_RSSI_T4G>,<P_RSRQ_T4G>,0



AT#JDRENH2=?

Test command reports the supported range of the parameters values.

3.6.2. AT#JDR4GCFG - LTE Jamming Detection Threshold Configuration

The command configures the LTE Jamming Detection thresholds.

SIM Presence	Setting saved	Can be aborted	MAX timeout	SELINT
Not required	Auto	No	-	2

```

➡ AT#JDR4GCFG=<P_RSRP_T4G>,<P_RSRQ_T4G>,<UNUSED_1>[,<UNUSED_2>[,<UNUSED_3>[,<
UNUSED_4>[,<UNUSED_5>[,<UNUSED_6>[,<UNUSED_7>]]]]]]
    
```

Set command allows to configure the LTE Jamming Detection thresholds. After configuration, use the #JDRENH2 command to enable/disable LTE jamming detection and select reporting mode.

Parameters:

Name	Type	Default	Description
<P_RSRP_T4G>	integer	20	set the threshold of RSRP. The threshold (RSRP_Thr) is calculated as: $RSRP_Thr = RSRP_Av * (1 + (<P_RSRP_T4G> / 100))$ where RSRP_Av is the average of the last 8 RSRP measures Value: 0÷100 : threshold of RSRP
<P_RSRQ_T4G>	integer	20	set the threshold of RSRQ. The threshold (RSRQ_Thr) is calculated as: $RSRQ_Thr = RSRQ_Av * (1 - (<P_RSRQ_T4G> / 100))$ where RSRQ_Av is the average of the last 8 RSRQ measures Value: 0÷100 : threshold of RSRQ
<UNUSED_1>	integer	-	reserved for future use, must be 0
<UNUSED_2>	mixed	-	reserved for future use
<UNUSED_3>	mixed	-	reserved for future use
<UNUSED_4>	mixed	-	reserved for future use
<UNUSED_5>	mixed	-	reserved for future use
<UNUSED_6>	mixed	-	reserved for future use
<UNUSED_7>	mixed	-	reserved for future use

```

← AT#JDR4GCFG?
    
```

Read command returns the current settings in the format:

```

#JDR4GCFG: <P_RSRP_T4G>,<P_RSRQ_T4G>,0,0,0,0,0,0
    
```

Regardless the values used for parameters <UNUSED_2> ... <UNUSED_7>, the read command returns always 0.

 **AT#JDR4GCFG=?**

Test command returns the range of supported values for all the parameters.

3.7. Packet Domain

3.7.1. AT+CGQREQ - Quality of Service Profile (Requested)

Set command allows to specify a Quality of Service Profile (requested) that is used when the terminal sends an Activate PDP Context Request message to the network. It specifies a profile for the context identified by the (local) context identification parameter, <cid>.



3GPP TS 27.007
3GPP TS 03.060
3GPP TS 23.060

SIM Presence	Setting saved	Can be aborted	MAX timeout	SELINT
Required	Auto	No	-	2



AT+CGQREQ=

- If a value is omitted for a particular class then this class, is not checked
- AT+CGQREQ=<cid>** is a special set command syntax that delates the PDP context identified by <cid> index.



AT+CGQREQ?

Read command returns the current settings for each defined context in the format:

**+CGQREQ:<cid>,<precedence>,<delay>,<reliability>,<peak>,<mean>[<CR><LF>
+CGQREQ:<cid>,<precedence>,<delay>,<reliability>,<peak>,<mean>[...]]**

- If no PDP context has been defined, it has no effect and **OK** result code is returned.



AT+CGQREQ=?

Test command returns as a compound value the type of the current PDP context and the supported values for the sub parameters in the format:

**+CGQREQ: <PDP_Type>,
(list of supported <precedence>s),(list of supported <delay>s),
(list of supported <reliability>s),(list of supported <peak>s),
(list of supported <mean>s)**

Additional info:

- ▶▶ PDP type meaning.

Name	Type	Default	Description
<PDP_Type>	string	-	specifies the type of packet data protocol (see +CGDCONT command)



```
AT+CGQREQ?  
+CGQREQ: 1,0,0,3,0,0  
OK
```

```
AT+CGQREQ=1,0,0,3,0,0  
OK
```

```
AT+CGQREQ=?  
+CGQREQ: "IP",(0-3),(0-4),(0-5),(0-9),(0-18,31)  
+CGQREQ: "PPP",(0-3),(0-4),(0-5),(0-9),(0-18,31)  
+CGQREQ: "IPV6",(0-3),(0-4),(0-5),(0-9),(0-18,31)  
OK
```

3.7.2. AT+CGDCONT - Define PDP Context

Define PDP Context.



3GPP TS 27.007

SIM Presence	Setting saved	Can be aborted	MAX timeout	SELINT
Required	Auto	No	-	2



AT+CGDCONT=[<cid>,<PDP_type>,<APN>,<PDP_addr>,<d-comp>,<h_comp>,<pd1>[,...,<pdN>]]]]]]]]]]

Set command specifies PDP context parameter values for a PDP context identified by the (local) context identification parameter, <cid>.

Parameters:

Name	Type	Default	Description
<cid>	integer	-	(PDP Context Identifier) numeric parameter which specifies a particular PDP context definition. 1..max - where the value of max is returned by the Test command.
<PDP_type>	string	N/A	(Packet Data Protocol type) a string parameter which specifies the type of packet data protocol. Values: "IP" : Internet Protocol "IPV6" : Internet Protocol version 6 "IPV4V6" : Virtual introduced to handle dual IP stack UE capability. "PPP" : Point to Point Protocol Non-IP : Transfer of Non-IP data to external packet data network
<APN>	string	-	(Access Point Name) a string parameter which is a logical name that is used to select the GGSN or the external packet data network. If the value is empty ("") or omitted, then the subscription value will be requested.
<PDP_addr>	string	-	A string parameter that identifies the terminal in the address space applicable to the PDP. The allocated address may be read using the +CGPADDR command.
<d-comp>	integer	0	Numeric parameter that controls PDP data compression. Values: 0 : PDP data compression off (default if value is omitted) 1 : PDP data compression on 2 : V.42bis (applicable only for products supporting GSM)
<h_comp>	integer	0	Numeric parameter that controls PDP header compression. Values: 0 : PDP header compression off (default if value is omitted) 1 : PDP header compression on

- 2 : RFC1144 (applicable only for products supporting GSM; applicable for SDCP only)
- 3 : RFC2507 (applicable only for products supporting GSM)
- 4 : RFC3095 (applicable only for products supporting GSM; applicable for PDCP only)

 A special form of the Set command, **AT+CGDCONT=<cid>**, causes the values for context number <cid> to become undefined.

AT+CGDCONT?

Read command returns the current settings for each defined context in the format:

```
+CGDCONT: <cid>,<PDP_type>,<APN>,<PDP_addr>,<d_comp>,<h_comp>,<IPv4AddrAlloc>,<emergency_indication><CR><LF>
```

```
+CGDCONT: <cid>,<PDP_type>,<APN>,<PDP_addr>,<d_comp>,<h_comp>,<IPv4AddrAlloc>,<emergency_indication>[...]
```

AT+CGDCONT=?

Test command returns values supported as a compound value.

```
</> AT+CGDCONT=1,"IP","APN","10.10.10.10",0,0
OK
AT+CGDCONT?
+CGDCONT: 1,"IP","APN","10.10.10.10",0,0,0,0
OK
AT+CGDCONT=?
+CGDCONT: (1-6),"IP",,(0-2),(0-4),(0,1),(0,1)
+CGDCONT: (1-6),"PPP",,(0-2),(0-4),(0,1),(0,1)
+CGDCONT: (1-6),"IPV6",,(0-2),(0-4),(0,1),(0,1)
+CGDCONT: (1-6),"IPV4V6",,(0-2),(0-4),(0,1),(0,1)
OK
```

3.7.3. AT+CGDSCONT - Define Secondary PDP Context

Define secondary PDP Context.



- [1] 3GPP TS 44.065
- [2] 3GPP TS 25.323
- [3] RFC1144
- [4] RFC2507
- [5] RFC3095

SIM Presence	Setting saved	Can be aborted	MAX timeout	SELINT
Not required	Auto	No	-	2



AT+CGDSCONT[<cid>,<p_cid>[,<d_comp>[,<h_comp>]]]

Set command specifies PDP context parameter values for a Secondary PDP context identified by the (local) context Identification parameter, <cid>.

Parameters:

Name	Type	Default	Description
<cid>	integer	-	specifies a particular PDP Context Identifier, see +CGDSCONT command.
<p_cid>	integer	-	specifies a particular PDP context definition which has been specified by use of the +CGDSCONT command. The parameter is local to the TE-MT interface.
<d_comp>	integer	0	controls PDP data compression (applicable for SNDCPonly) (refer 3GPP TS 44.065 [61])

Values:

- 0 : off (default if value is omitted)
- 1 : on (manufacturer preferred compression)
- 2 : V.42 bis

<h_comp>	integer	0	controls PDP header compression (refer 3GPP TS 44.065 [61] and 3GPP TS 25.323 [62]).
----------	---------	---	--

Values:

- 0 : off (default if value is omitted)
- 1 : on (manufacturer preferred compression)
- 2 : RFC1144 (applicable for SNDCP only)
- 3 : RFC2507
- 4 : RFC3095 (applicable for PDCP only)



AT+CGDSCONT?

The read command returns the current settings for each defined context in the format:

```
+CGDSCONT: <cid>,<p_cid>,<d_comp>,<h_comp>[<CR><LF>
+CGDSCONT: <cid>,<p_cid>,<d_comp>,<h_comp> [...]]
```



AT+CGDSCONT=?

Test command returns the supported range of values of parameters.

3.7.4. AT+CGSCONTRDP - Secondary PDP Context Read Dynamic Parameters

This command returns parameters for a given <cid>.

SIM Presence	Setting saved	Can be aborted	MAX timeout	SELINT
Not required	No	No	-	2



AT+CGSCONTRDP[=<cid>]

The execution command returns <p_cid> and <bearer_id> parameters for a given <cid>. If the context cannot be found an **ERROR** response is returned. If the parameter <cid> is omitted, the <cid>, <p_cid> and <bearer_id> are returned for all established PDP contexts. Format of the returned message:

```
+CGSCONTRDP:<cid>,<p_cid>,<bearer_id>[<CR><LF>
+CGSCONTRDP: <cid>,<p_cid>,<bearer_id> [...]]
```

Parameter:

Name	Type	Default	Description
<cid>	integer	-	specifies a particular PDP context or Traffic Flows definition. The parameter is local to the TE-MT interface and is used in other PDP context-related commands.

Additional info:

▶▶ Here is the list of the parameters meanings returned by the **+CGSCONTRDP** command.

Name	Type	Default	Description
<p_cid>	integer	-	specifies a particular PDP context definition or default EPS context Identifier which has been specified by use of the +CGDCONT command. The parameter is local to the TE-MT interface.
<bearer_id>	integer	-	identifies the bearer, EPS Bearer in EPS and NSAPI in GPRS.



AT+CGSCONTRDP=?

The test command returns a list of <cid>s associated with active contexts:

+CGSCONTRDP: (list of <cid>s associated with active contexts)

- i** Parameters for network-initiated PDP contexts returned as well. The dynamic part of the PDP context will only exist if established by the network.

3.7.5. AT+CGQMIN - Quality of Service Profile (Minimum Acceptable)

Set command allows to specify a minimum acceptable profile which is checked by the terminal against the negotiated profile returned in the Activate PDP Context Accept message.



3GPP TS 27.007
3GPP TS 03.060
3GPP TS 23.060



SIM Presence	Setting saved	Can be aborted	MAX timeout	SELINT
Required	Auto	No	-	2



AT+CGQMIN=[<cid>[,<precedence>[,<delay>[,<reliability>[,<peak>[,<mean>]]]]]]]

Parameters:

Name	Type	Default	Description
<cid>	integer	-	PDP context identification (see +CGDCONT command)
<precedence>	integer	0	precedence class
	Value:		
	0÷max	:	use test command to know the values range
<delay>	integer	0	delay class
	Value:		
	0÷max	:	use test command to know the values range
<reliability>	integer	0	reliability class
	Value:		
	0÷max	:	use test command to know the values range
<peak>	integer	0	peak throughput class
	Value:		
	0÷max	:	use test command to know the values range
<mean>	integer	0	mean throughput class
	Value:		
	0÷max	:	use test command to know the values range

-  If a value is omitted for a class, then this class is not checked.
-  A special form of the set command, **AT+CGQMIN=<cid>** causes the requested profile for context number <cid> to become undefined.

**AT+CGQMIN?**

Read command returns the current settings for each defined context in the format:

+CGQMIN: <cid>,<precedence>,<delay>,<reliability>,<peak>,<mean>[<CR><LF>

+CGQMIN: <cid>,<precedence>,<delay>,<reliability>,<peak>,<mean>[...]]



If no PDP context has been defined, it has no effect and **OK** result code is returned

**AT+CGQMIN=?**

Test command returns as a compound value the type of the current PDP context and the supported values for the sub parameters in the format:

**+CGQMIN: <PDP_Type>,
(list of supported <precedence>s),(list of supported <delay>s),
(list of supported <reliability>s),(list of supported <peak>s),
(list of supported <mean>s)**

Additional info:

▶▶ PDP type meaning.

Name	Type	Default	Description
<PDP_Type>	string	-	specifies the type of packet data protocol, see +CGDCONT command Only the "IP" <PDP_Type> is currently supported.

3.7.6. AT+CGPADDR - Show PDP Address

This command returns a list of PDP addresses for the specified context identifiers.



3GPP TS 27.007

SIM Presence	Setting saved	Can be aborted	MAX timeout	SELINT
Required	No	No	-	2



AT+CGPADDR=[<cid>[,...]]

Execution command returns a list of PDP addresses for the specified context identifiers.

Parameter:

Name	Type	Default	Description
<cid>	integer	-	specifies a PDP context definition, see +CGDCONT command. If no <cid> specified, the addresses for all defined contexts are returned.

Additional info:

- ▶▶ The command returns a row of information for every <cid> whose context has been defined. No row is returned for a <cid> whose context has not been defined. Here is the response format:

```
+CGPADDR: <cid>,<PDP_addr><CR><LF>
+CGPADDR: <cid>,<PDP_addr><CR><LF>
...
```

Name	Type	Default	Description
<PDP_addr>	string	-	identifies the terminal in an address space applicable to the PDP. The address may be static or dynamic:

- for a static address, it will be the one set by the **+CGDCONT** command when the context was defined
- for a dynamic address it will be the one assigned during the last PDP context activation that used the context definition referred to by <cid>; <PDP_addr> is omitted if none is available



AT+CGPADDR=?

Test command returns a list of defined <cid>.



```
AT#SGACT=3,1
#SGACT: xxx.yyy.zzz.www
OK
```

```
AT+CGPADDR=3
+CGPADDR: 3,"xxx.yyy.zzz.www"
OK
```

```
AT+CGPADDR=?
+CGPADDR: (3)
OK
```

3.7.7. AT+CGCMOD - Modify PDP Context

The execution command is used to modify the specified PDP context(s) with respect to QoS profiles and TFTs.

SIM Presence	Setting saved	Can be aborted	MAX timeout	SELINT
Required	No	No	-	2



AT+CGCMOD=[<cid_n>[,...]]

After command has completed, the MT returns to V.250 online data state. If the requested modification for any specified context cannot be achieved, an **ERROR** or **+CME: ERROR** response is returned. Extended error responses are enabled by the **+CMEE** command.

For EPS, the modification request for an EPS bearer resource will be answered by the network by an EPS bearer Modification request. The request must be accepted by the MT before the PDP context effectively changed.

Parameter:

Name	Type	Default	Description
<cid_n>	integer	-	generic PDP context identifier.

-  If no parameters are specified (no <cid_n> specified), the command modifies all active contexts.



AT+CGCMOD=?

Test command returns a list of <cid_n>s associated with active contexts.

+CGCMOD: (list of <cid_n>s associated with active contexts)

3.7.8. AT#AUTOATT - Auto-Attach Property

Execution command has no effect and is included only for backward compatibility.

SIM Presence	Setting saved	Can be aborted	MAX timeout	SELINT
Required	Auto	No	-	2



AT#AUTOATT=[<auto>]

Parameter:

Name	Type	Default	Description
<auto>	integer	0	dummy parameter

Values:

- 0 : dummy parameter
- 1 : dummy parameter



Entering **AT#AUTOATT=** returns **OK** but has no effect.



AT#AUTOATT?

Read command reports <auto> value, in the format:

#AUTOATT: <auto>



AT#AUTOATT=?

Test command reports available values for parameter <auto>.

3.7.9. AT#MSCLASS - Multislot Class Control

Set command sets the GPRS multislot class.

SIM Presence	Setting saved	Can be aborted	MAX timeout	SELINT
Required	Auto	No	-	2



AT#MSCLASS=[<class>[,<autoattach>]]

Parameters:

Name	Type	Default	Description
<class>	integer	33	GPRS multislot class.
Values:			
1÷12	:	class	
30÷33	:	class	
<autoattach>	integer	0	specify when the new multislot class will be enabled.
Values:			
0	:	the new multislot class is enabled only at the next detach/attach or after a reboot.	
1	:	the new multislot class is enabled immediately, automatically forcing a detach / attach procedure only in case of GSM network registered	



AT#MSCLASS?

Read command reports the current value of the multislot class in the format:

#MSCLASS: <class>



AT#MSCLASS=?

Test command reports the range of available values for both parameters **<class>** and **<autoattach>**.

3.7.10. AT#GAUTH - PPP Data Connection Authentication Type

This command sets the authentication type used in PDP Context Activation during PPP-PS connections.

SIM Presence	Setting saved	Can be aborted	MAX timeout	SELINT
Required	No	No	-	2



AT#GAUTH=[<type>]

Set command sets the authentication type used in PDP Context Activation during PPP-PS connections.

Parameter:

Name	Type	Default	Description
<type>	integer	3	authentication type used in PDP Context Activation during PPP-PS connections

Values:

- 0 : no authentication
- 1 : PAP authentication
- 2 : CHAP authentication
- 3 : AUTO authentication (PAP or CHAP or no authentication according to host application)

-  if the settings on the server side (the host application) of the PPP are not compatible with the #GAUTH setting, then the PDP Context Activation will use no authentication.



AT#GAUTH?

Read command reports the current authentication type, in the format:

#GAUTH: <type>



AT#GAUTH=?

Test command returns the range of supported values for parameter <type>.

3.7.11. AT+CGAUTH - Define PDP Context Authentication Parameters

This command allows the TE to specify authentication parameters for a PDP context.



3GPP TS 27.007

SIM Presence	Setting saved	Can be aborted	MAX timeout	SELINT
Not required	Auto	No	-	2



AT+CGAUTH=<cid>,<auth_type>,<username>,<password>

Set command allows the TE to specify authentication parameters for a PDP context identified by the (local) context identification parameter <cid>, used during the PDP context activation and the PDP context modification procedures.

Parameters:

Name	Type	Default	Description
<cid>	integer	-	specifies a particular PDP context definition, see the +CGDCONT command.
<auth_type>	integer	0	selects the authentication protocol used for this PDP context.
Values:			
	0	:	no authentication
	1	:	PAP authentication
	2	:	CHAP authentication
<username>	string	-	User name for access to the IP network
<password>	string	-	Password for access to the IP network



AT+CGAUTH?

Read command returns the PDP authentication parameters, excluding <password>, for every defined PDP context, in the format:

```
+CGAUTH: <cid1>,< auth_type1 >,<username1><CR><LF>
...
+CGAUTH:<cidmax>,<auth_ttypemax >,<username_max><CR><LF>
```



AT+CGAUTH=?

Test command reports the supported range of values for parameters <cid> and <auth_type> .

3.7.12. AT+CGCONTRDP - PDP Context Read Dynamic Parameters

The execution command returns the relevant information for a PDP Context established by the network.



3GPP TS 27.007

SIM Presence	Setting saved	Can be aborted	MAX timeout	SELINT
Required	Auto	No	-	2



AT+CGCONTRDP[=<cid>]

The execution command returns the relevant information on a PDP Context established by the network with the context identifier <cid>. If the parameter <cid> is omitted, the information for all established PDP contexts is returned. The response message has the following format:

```
+CGCONTRDP:<cid>,<bearerId>,<apn>[,<ip&subnet>[,<gw_addr>[,<DNS_prim>
[,<DNS_sec>[, <P_CSCF_prim>[,<P_CSCF_sec>]]]]]]][<CR><LF>
+CGCONTRDP:<cid>,<bearerId>,<apn>[, <ip&subnet_mask>[,<gw_addr>[,<DNS_prim>
[,<DNS_sec>[, <P_CSCF_prim>[,<P_CSCF_sec>]]]]]] [...]]
```

If the context cannot be found an **ERROR** response is returned.
 The response message parameters are described in the Additional info section.

Parameter:

Name	Type	Default	Description
<cid>	integer	-	identifies a non secondary PDP context definition. The parameter is local to the TE-MT interface and is used in other PDP context-related commands.

Additional info:

- ▶▶ List of the meaning of the response message parameters.

Name	Type	Default	Description
<berrerrId>	integer	-	identifies the bearer, EPS Bearer in EPS and NSAPI in UMTS/GPRS.
<apn>	string	-	logical name used to select the GGSN or the external packet data network.
<ip&subnet>	string	-	IP address and subnet mask of the MT. The string is given as dot-separated numeric (0-255) parameters on the form. For more information, see next Additional info section.
<gw_addr>	string	-	Gateway address of the MT. The string is given as dot-separated numeric (0-255) parameters.
<DNS_prim>	string	-	IP address of the primary DNS Server.
<DNS_sec>	string	-	IP address of the secondary DNS Server.
<P_CSCF_prim>	string	-	IP address of the primary P-CSCF Server.
<P_CSCF_sec>	string	-	IP address of the secondary P-CSCF Server.

-
- Referring to **<ip&subnet>** parameter:
the string is given as dot-separated numeric (0-255) parameters. The format is:



for IPv4:

"a1.a2.a3.a4.m1.m2.m3.m4"

for IPv6:

"a1.a2.a3.a4.a5.a6.a7.a8.a9.a10.a11.a12.a13.a14.a15.a16.
m1.m2.m3.m4.m5.m6.m7.m8.m9.m10.m11.m12. m13.m14.m15.m16"

When **+CGPIAF** is supported, its settings can influence the format of this parameter returned with the execute form of **+CGCONTRDP**.

-  The dynamic part of the PDP context will only exist if established by the network. The test command returns a list of **<cid>**s associated with active contexts.
-  If the MT has dual stack capabilities, two lines of information are returned per **<cid>**. First one line with the IPv4 parameters followed by one line with the IPv6 parameters.



AT+CGCONTRDP=?

Return the list of **<cid>**s associated with active contexts.

3.7.13. AT+CGPIAF - Printing IP Address Format

This command selects the printout format of the IPv6 address.



3GPP TS 27.007

SIM Presence	Setting saved	Can be aborted	MAX timeout	SELINT
Not required	No	No	-	2



AT+CGPIAF=[<IPv6_AddressFormat>[,<IPv6_SubnetNotation>[,<IPv6_LeadingZeros>[,<Pv6_CompressZeros>]]]]

Parameters:

Name	Type	Default	Description
<IPv6_AddressFormat>	integer	0	selects the IPv6 address format. Relevant for all AT command parameters that can hold an IPv6 address.
Values:			
0	:	use IPv4-like dot-notation. IP addresses, and subnetwork mask if applicable, are dot-separated.	
1	:	use IPv6-like colon-notation. IP address, and subnetwork mask if applicable and when given explicitly, are separated by a space.	
<IPv6_SubnetNotation>	integer	0	selects the subnet-notation for remote address and subnet mask. Setting does not apply if IPv6 address format <IPv6_AddressFormat>=0 .
Values:			
0	:	both IP address, and subnet mask are started explicitly, separated by a space.	
1	:	the printout format is applying /(forward slash) subnet-prefix Classless Inter-Domain Routing (CIDR) notation.	
<IPv6_LeadingZeros>	integer	0	selects whether leading zeros are omitted or not. Setting does not apply if IPv6 address format <IPv6_AddressFormat>=0 .
Values:			
0	:	leading zeros are omitted.	
1	:	leading zeros are included.	
<Pv6_CompressZeros>	integer	0	selects whether 1-n instances of 16-bit- zero values are replaced by only "::". This applies only once. Setting does not apply if IPv6 address format <IPv6_AddressFormat>=0 .
Values:			
0	:	no zero compression.	
1	:	use zero compression.	

**AT+CGPIAF?**

Read command returns the current parameter setting.

**AT+CGPIAF=?**

Test command returns values supported as compound values.



```
AT+CGPIAF=0,0,0,0
OK
```

```
AT#SGACT=1,1
#SGACT: 252.1.171.171.205.205.239.224.0.0.0.0.0.1
OK
```

```
AT+CGPIAF=1,0,0,0
OK
```

```
AT#SGACT=1,1
#SGACT: FC01:ABAB:CD:CD:EFE0:0:0:0:1
OK
```

3.7.14. AT+CGACT - PDP Context Activate or Deactivate

This command activates or deactivates the specified PDP context(s).



3GPP TS 27.007



SIM Presence	Setting saved	Can be aborted	MAX timeout	SELINT
Required	No	No	-	2



AT+CGACT=[<state>[,<cid>[,<cid>][,...]]]

Parameters:

Name	Type	Default	Description
<state>	integer	N/A	activate/deactivate the PDP context
Values:			
0	:	deactivate	
1	:	activate	
<cid>	integer	-	specifies a PDP context definition (see +CGDCONT command)

-  Only three <cid>s can be activated at the same time.
-  if no <cid>s are specified, the activation form of the command activates the first three defined contexts. The deactivation form deactivates all the active contexts.



AT+CGACT?

Read command returns the current activation state for all the defined PDP contexts in the format:

```
+CGACT: <cid>,<state>[<CR><LF>
+CGACT: <cid>,<state>[...]]
```



AT+CGACT=?

Test command reports information on the supported PDP context activation states <state>.



```
AT+CGACT=1,1
OK
```

```
AT+CGACT?
+CGACT: 1,1
OK
```

3.7.15. AT+CGEREP - Packet Domain Event Reporting

This command enables or disables the presentation of unsolicited result codes.



3GPP TS 27.007

SIM Presence	Setting saved	Can be aborted	MAX timeout	SELINT
Required	Specific profile	No	-	2



AT+CGEREP=[<mode>[,<bfr>]]

Set command enables/disables sending of unsolicited result codes in case of certain events occurring in the module or in the network. The URC formats and related events are shown in the Additional info sections.

Parameters:

Name	Type	Default	Description
<mode>	integer	0	controls the processing of URCs specified with this command.
Values:			
0	:	buffer unsolicited result codes in the TA. If TA result code buffer is full, the oldest one can be discarded. No codes are forwarded to the TE.	
1	:	discard unsolicited result codes when TA-TE link is reserved (e.g. in on-line data mode); otherwise forward them directly to the TE.	
2	:	buffer unsolicited result codes in the TA when TA-TE link is reserved (e.g. in on-line data mode) and flush them to the TE when TA-TE link becomes available; otherwise forward them directly to the TE.	
<bfr>	integer	0	controls the effect on buffered codes when <mode> 1 or 2 is entered.

Values:

- 0 : TA buffer of unsolicited result codes defined within this command is cleared when <mode> 1 or 2 is entered.
- 1 : TA buffer of unsolicited result codes defined within this command is flushed to the TE when <mode> 1 or 2 is entered (OK response shall be given before flushing the codes)

Additional info:

- ▶▶ A network request for PDP context activation occurred when the TA was unable to report it to the TE with a **+CRING** unsolicited result code and was automatically rejected.

+CGEV: REJECT <PDP_type>, <PDP_addr>

- ▶▶ The network has requested a context reactivation. The <cid> that was used to reactivate the context is provided if known to TA.

+CGEV: NW REACT <PDP_type>, <PDP_addr>, [<cid>]

- ▶▶ The network has forced a context deactivation. The **<cid>** that was used to activate the context is provided if known to TA.

+CGEV: NW_DEACT <PDP_type>, <PDP_addr>, [<cid>]

- ▶▶ The mobile equipment has forced a PS detach. This implies that all active contexts have been deactivated. These are not reported separately.

+CGEV: ME_DETACH

- ▶▶ The network has forced a PS detach. This implies that all active contexts have been deactivated. These are not reported separately.

+CGEV: NW_DETACH

- ▶▶ The mobile equipment has forced a change of MS class. The highest available class is reported (see **+CGCLASS**).

+CGEV: ME CLASS <class>

Unsolicited fields:

Name	Type	Description
<PDP_type>	string	Packet Data Protocol type, which specifies the type of packet data protocol
<PDP_addr>	string	identifies the terminal in the address space applicable to the PDP
<cid>	integer	PDP Context Identifier



AT+CGEREP?

Read command returns the current **<mode>** and **<bfr>** settings, in the format:

+CGEREP: <mode>,<bfr>



AT+CGEREP=?

Test command reports the supported range of values for the **+CGEREP** command parameters.

3.7.16. AT#PPPCFG - PPP Configuration

This command configures the PPP mode.

SIM Presence	Setting saved	Can be aborted	MAX timeout	SELINT
Not required	Auto	No	-	2



AT#PPPCFG=<mode>

Set command sets the active/passive PPP mode

Parameter:

Name	Type	Default	Description
<mode>	integer	1	sets PPP mode

Values:

- 0 : passive mode
- 1 : active mode



AT#PPPCFG?

Read command returns the current <mode>, in the format:

#PPPCFG: <mode>



AT#PPPCFG=?

Test command returns the range of available values for parameters <mode> .

3.7.17. AT+CGREG - GPRS Network Registration Status

Set command controls the presentation of the **+CGREG**: unsolicited result code



3GPP TS 27.007
3GPP TS 24.008

SIM Presence	Setting saved	Can be aborted	MAX timeout	SELINT
Not required	No	No	-	2



AT+CGREG=[<mode>]

Set command enables/disables the **+CGREG**: unsolicited result code, and selects one of the available formats:

short format:

+CGREG:<stat>

long format:

+CGREG:<stat>[,<lac>,<ci>[,<AcT>,<rac>]]

extra long format:

+CGREG:<stat>[, [<lac>], [<ci>], [<AcT>], [<rac>][, [, [<ActiveTime>], [<PeriodicRAU>], [<GPRSREADYtimer>]]]

Parameter:

Name	Type	Default	Description
<mode>	integer	0	enables/disables the network registration unsolicited result code (URC), and selects one of the available formats. The following events triggers the URC: <ul style="list-style-type: none"> • URC short format is displayed every time there is a change in the network registration status • URC long or extra long format is displayed, according to <mode> value, every time there is a change of the network cell.

Values:

- 0 : disable the network registration unsolicited result code
- 1 : enable the network registration unsolicited result code, and selects the short format
- 2 : enable the network registration unsolicited result code, and selects the long format (includes the network cell identification data)
- 4 : enable the network registration and location information unsolicited result code (extra long format)

Unsolicited fields:

Name	Type	Description
<stat>	integer	registration status of the module

Values:

		0	: not registered, terminal is not currently searching a new operator to register to									
		1	: registered, home network									
		2	: not registered, but terminal is currently searching a new operator to register to									
		3	: registration denied									
		4	: unknown									
		5	: registered, roaming									
<lac>	string	the parameter reports: <ul style="list-style-type: none"> Local Area Code when <AcT>=0 Tracking Area Code when <AcT>=8 or 9 										
<ci>	string	cell ID in hexadecimal format										
<AcT>	integer	access technology of the registered network. Values: <table border="0" style="margin-left: 20px;"> <tr> <td>0</td> <td>:</td> <td>GSM</td> </tr> <tr> <td>8</td> <td>:</td> <td>CAT M1</td> </tr> <tr> <td>9</td> <td>:</td> <td>NB IoT</td> </tr> </table>		0	:	GSM	8	:	CAT M1	9	:	NB IoT
0	:	GSM										
8	:	CAT M1										
9	:	NB IoT										
<rac>	string	routing area code (one byte) in hexadecimal format										
<ActiveTime>	string	one byte in an 8 bit format. Indicates the Active Time value (T3324) allocated to the UE. The Active Time value is coded as one byte (octet 3) of the GPRS Timer 2 information element coded as bit format (e.g. "00100100" equals 4 minutes). For the coding and the value range, see the GPRS Timer 2 IE in 3GPP TS 24.008.										
<PeriodicRAU>	string	one byte in an 8 bit format. Indicates the extended periodic RAU value (T3312) allocated to the UE. The extended periodic RAU value s coded as one byte (octet 3) of the GPRS Timer 3 information element coded as bit format (e.g. "01000111" equals 70 hours). For the coding and the value range, see the GPRS Timer 3 IE in 3GPP TS 24.008.										
<GPRSREADYtimer>	string	one byte in an 8 bit format. Indicates the GPRS READY timer value (T3314) allocated to the UE. The GPRS READY timer value is coded as one byte (octet 2) of the GPRS Timer information element coded as bit format (e.g. "01000011" equals 3 decihours or 18 minutes). For the coding and the value range, see the GPRS Timer IE in 3GPP TS 24.008.										

i **<lac>**, **<ci>**, **<AcT>**, and **<rac>** network information is reported by URC only if **<mode>**=2 or 4, and the module is registered on some network cell.



AT+CGREG?

Read command returns the current value of **<mode>**, the registration status **<stat>**, and the network information (**<lac>**, **<ci>**, **<AcT>**, and **<rac>**) according to the used **<mode>** parameter value.

+CGREG: <mode>,<stat>[,<lac>,<ci>[,<AcT>,<rac>]]

<lac>, **<ci>**, **<AcT>**, and **<rac>** network information is reported only if **<mode>**=2 or 4 and the module is registered on some network cell.

**AT+CGREG=?**

Test command returns supported values for parameter **<mode>**.

3.7.18. AT+CGATT - PS Attach or Detach

This execution command is used to register (attach) the terminal to or deregister (detach) the terminal from the Packet Domain service.



3GPP TS 27.007

SIM Presence	Setting saved	Can be aborted	MAX timeout	SELINT
Required	No	No	-	2



AT+CGATT=<state>

Parameter:

Name	Type	Default	Description
<state>	integer	N/A	state of PS attachment

Values:

- 0 : detached
- 1 : attached



AT+CGATT?

Read command returns the current PS state in the format:

+CGATT: <state>



AT+CGATT=?

Test command returns the values range of the <state> parameter.



```
AT+CGATT?
+CGATT: 0
OK
```

```
AT+CGATT=?
+CGATT: (0,1)
OK
```

```
AT+CGATT=1
OK
```

3.8. SIM

3.8.1. AT+CPIN - Enter the PIN

The command sends to the device a password which is necessary before it can be operated.



3GPP TS 27.007

SIM Presence	Setting saved	Can be aborted	MAX timeout	SELINT
Not required	Other	No	-	2



AT+CPIN=<pin>[,<newpin>]

Set command sends to the device a password which is necessary before it can be operated (SIM PIN, SIM PUK, PH-SIM PIN, etc.).

If the PIN required is SIM PUK or SIM PUK2, the <newpin> is required. This <newpin>, will replace the old pin in the SIM.

The command may be used to change the SIM PIN by sending it with both parameters <pin> and <newpin>.

Parameters:

Name	Type	Default	Description
<pin>	string	-	PIN required or old PIN if the command is used to change the SIM PIN
<newpin>	string	-	new PIN that will replace old pin



AT+CPIN?

Read command reports the PIN/PUK/PUK2 request status of the device in the form:

+CPIN: <code>

Additional info:

▶▶ Parameters:

Name	Type	Default	Description
<code>	string	N/A	PIN/PUK/PUK2 request status code

Values:

READY	:	ME is not pending for any password
SIM PIN	:	ME is waiting SIM PIN to be given
SIM PUK	:	ME is waiting SIM PUK to be given
PH-SIM PIN	:	ME is waiting phone-to-SIM card password to be given

PH-FSIM PIN	:	ME is waiting phone-to-very first SIM card password to be given
PH-FSIM PUK	:	ME is waiting phone-to-very first SIM card unblocking password to be given
SIM PIN2	:	ME is waiting SIM PIN2 to be given; this <code> is returned only when the last executed command resulted in PIN2 authentication failure (i.e. +CME ERROR: 17)
SIM PUK2	:	ME is waiting SIM PUK2 to be given; this <code> is returned only when the last executed command resulted in PUK2 authentication failure (i.e. +CME ERROR: 18)
PH-NET PIN	:	ME is waiting network personalization password to be given
PH-NET PUK	:	ME is waiting network personalization unblocking password to be given
PH-NETSUB PIN	:	ME is waiting network subset personalization password to be given
PH-NETSUB PUK	:	ME is waiting network subset personalization unblocking password to be given
PH-SP PIN	:	ME is waiting service provider personalization password to be given
PH-SP PUK	:	ME is waiting service provider personalization unblocking password to be given
PH-CORP PIN	:	ME is waiting corporate personalization password to be given
PH-CORP PUK	:	ME is waiting corporate personalization unblocking password to be given

-  Pin pending status at startup depends on PIN facility setting; to change or query the default power up setting use the command **AT+CLCK**.



AT+CPIN=?

Test command returns **OK** result code.



```
AT+CME=1
OK
```

```
AT+CPIN?
+CME ERROR: 10
error: you have to insert the SIM
```

```
AT+CPIN?
+CPIN: READY
OK
you inserted the SIM and module is not waiting for PIN
```

3.8.2. AT#PCT - Display PIN Counter

This command reports the PIN/PUK or PIN2/PUK2 input remaining attempts, if **+CPIN** password is required.

SIM Presence	Setting saved	Can be aborted	MAX timeout	SELINT
Not required	No	No	-	2



AT#PCT

Execution command reports the PIN/PUK or PIN2/PUK2 input remaining attempts, depending on **+CPIN** requested password, in the format:

#PCT: <n>

Additional info:

▶▶ Here is shown the parameter meaning.

Name	Type	Default	Description
<n>	integer	N/A	remaining attempts.

Values:

- 0 : the SIM is blocked
- 1÷3 : if the device is waiting either SIM PIN or SIM PIN2 to be given.
- 1÷10 : if the device is waiting either SIM PUK or SIM PUK2 to be given.



AT#PCT=?

Test command returns the **OK** result code.



```
AT+CPIN?
+CPIN: SIM PIN
OK
```

```
AT#PCT          Check PIN remained counter
#PCT: 3
OK
```

```
AT+CPIN=1111   Input incorrect PIN number
+CME ERROR: incorrect password
```

```
AT#PCT
#PCT: 2
OK
```

3.8.3. AT+CCID - Read ICCID

Execution command reads on SIM the Integrated Circuit Card Identification (ICCID). It is the card identification number that provides a unique identification number for the SIM.

SIM Presence	Setting saved	Can be aborted	MAX timeout	SELINT
Required	Other	No	-	2



AT+CCID

The command returns the following message:

```
+CCID: <ICCID>
OK
```



AT+CCID=?

Test command returns the **OK** result code.



```
AT+CCID
+CCID: 89861109091740011006
OK
```

3.8.4. AT+CIMI - International Mobile Subscriber Identity (IMSI)

This command returns the International Mobile Subscriber Identity (IMSI number).



3GPP TS 27.007

SIM Presence	Setting saved	Can be aborted	MAX timeout	SELINT
Required	No	No	-	2



AT+CIMI

Execution command returns the value of the International Mobile Subscriber Identity stored in the SIM, the returned message has the following format (with command no echoed):

```
<IMSI value>
OK
```

 If the SIM is not inserted, the command returns **ERROR**.



AT+CIMI=?

Test command returns **OK** result code



```
AT+CIMI
22201701202507
OK
```

3.8.5. AT#CIMI - International Mobile Subscriber Identity (IMSI)

This command returns the International Mobile Subscriber Identity (IMSI number).

SIM Presence	Setting saved	Can be aborted	MAX timeout	SELINT
Required	No	No	-	2



AT#CIMI

Execution command returns the value of the International Mobile Subscriber Identity stored in the SIM, the returned message has the following format (with command echoed):

```
#CIMI: <IMSI value>
OK
```



If the SIM is not inserted, the command returns **ERROR**.



AT#CIMI=?

Test command returns the **OK** result code.



```
AT#CIMI
#CIMI: 450050209516643
OK
```

3.8.6. AT#SIMDET - SIM Detection Mode

The command manages the SIM Detection mode.



[1] Telit Hardware Design Guide of the used module.

SIM Presence	Setting saved	Can be aborted	MAX timeout	SELINT
Not required	Common profile	No	-	2



AT#SIMDET=<mode>

Set command simulates the SIM status or selects the automatic SIM Detection status. This command is used by modules providing the dedicated SIMIN pin. Refer to document [1] to have information on dedicated SIMIN pin.

Parameter:

Name	Type	Default	Description
<mode>	integer	2	the <mode> parameter can be used as shown in Values section.

Values:

- 0 : ignores dedicated SIMIN pin, and simulate the status "SIM Not Inserted"
- 1 : ignores dedicated SIMIN pin, and simulate the status "SIM Inserted"
- 2 : selects automatic SIM detection using dedicated SIMIN Pin



When #SIMDET=1 (that simulates "SIM Inserted") is issued, a query to detect the presence of the SIM is forced, regardless of SIMIN pin status. If SIM is not responding (for example, because it is not present) then, after a timeout, the modem gives up and sets the SIM status to SIM NOT INSERTED. If SIM is correctly answering to queries then SIM status becomes SIM READY.



AT#SIMDET?

Read command returns the currently selected Sim Detection Mode in the format:

#SIMDET: <mode>,<simIn>

Additional info:

▶▶ The values for <simIn> are:

Name	Type	Default	Description
<simIn>	integer	0	SIMIN pin status.

Values:

- 0 : SIM not inserted
- 1 : SIM inserted



AT#SIMDET=?

Test command reports the supported range of values for parameter <mode>.

3.8.7. AT#SIMPR - SIM Presence Status

The command enables/disables the SIM Presence Status unsolicited indication.

SIM Presence	Setting saved	Can be aborted	MAX timeout	SELINT
Not required	Specific profile	No	-	2



AT#SIMPR=[<mode>]

Set command enables/disables the SIM Presence Status unsolicited indication in the ME. This command reports also the status of the remote SIM, if the SIM Access Profile (SAP) functionality is supported and has been enabled.

If notification is enabled, the ME informs about every (local and remote) SIM status change through the following URC:

#SIMPR: <SIM>,<status>

Parameter:

Name	Type	Default	Description
<mode>	integer	0	Specifies if notification must be enabled or disabled.

Values:

- 0 : notification disabled
- 1 : notification enabled

Unsolicited fields:

Name	Type	Description
<SIM>	integer	Reports local or remote SIM
Values:		
0	:	local SIM
1	:	remote SIM
<status>	integer	Reports current SIM status
Values:		
0	:	SIM not inserted
1	:	SIM inserted



Entering **AT#SIMPR=** returns **OK** but has no effect.



AT#SIMPR?

Read command reports whether the unsolicited indication **#SIMPR:** is currently enabled or not, along with the local and remote SIM status, in the format:

#SIMPR: <mode>,0,<status><CR><LF>
#SIMPR: <mode>,1,<status>

 If SAP functionality is not supported or enabled the remote SIM status will always be 0



AT#SIMPR=?

Test command reports the range for the parameter **<mode>**

3.8.8. AT#CCID - Read ICCID

Execution command reads on SIM the Integrated Circuit Card Identification (ICCID). It is the card identification number that provides a unique identification number for the SIM.

SIM Presence	Setting saved	Can be aborted	MAX timeout	SELINT
Required	No	No	-	2



AT#CCID

The command returns the following message:

```
#CCID: <ICCID>
OK
```



AT#CCID=?

Test command returns the **OK** result code.



```
AT#CCID
#CCID: 89861109091740011006
OK
```

3.8.9. AT#QSS - Query SIM Status

Query SIM Status.

SIM Presence	Setting saved	Can be aborted	MAX timeout	SELINT
Not required	Specific profile	No	-	2



AT#QSS=[<mode>]

Enables/disables the Query SIM Status unsolicited indication in the ME. The format of the unsolicited indication is the following:

#QSS: <status>

The parameter is described in the Unsolicited field section.

Parameter:

Name	Type	Default	Description
<mode>	integer	0	Type of notification

Values:

- 0 : disabled. It is only possible to query the current SIM status through read command AT#QSS?
- 1 : enabled. The ME informs at every SIM status change through the basic unsolicited indication where <status> range is 0...1
- 2 : enabled. The ME informs at every SIM status change through the basic unsolicited indication where <status> range is 0...3

Unsolicited field:

Name	Type	Description
<status>	integer	current SIM status

Values:

- 0 : SIM not inserted
- 1 : SIM inserted
- 2 : SIM inserted, and PIN unlocked
- 3 : SIM inserted and READY (SMS and Phonebook access are possible)



The command reports the SIM status change after the <mode> has been set to 2. It is strongly suggested to set <mode>=2 and save the value in the user profile, then power off the module. The proper SIM status will be available at the next power on.



AT#QSS?

Read command reports whether the unsolicited indication #QSS is currently enabled or not, along with the SIM status, in the format:

#QSS: <mode>,<status>

The parameters are described in the previous sections.



AT#QSS=?

Test command returns the supported range of values for parameter **<mode>**.

3.8.10. AT+CRSM - Restricted SIM access

The command transmits to the UICC some specific commands and their required parameters.



3GPP TS 11.11
3GPP TS 31.101
3GPP TS 31.102

SIM Presence	Setting saved	Can be aborted	MAX timeout	SELINT
Required	No	No	-	2



AT+CRSM=<command>[,<fileId>[,<P1>[,<P2>[,<P3>[,<data>]]]]]

Set command transmits to the UICC the specific command and its required parameters. The command response shows the status words and response data returned by the UICC in the format:

+CRSM: <sw1>,<sw2>[,<response>]

For parameters meanings see Additional info section.

Parameters:

Name	Type	Default	Description
<command>	integer	176	command passed on to the UICC
Values:			
176	:	READ BINARY	
178	:	READ RECORD	
192	:	GET RESPONSE	
214	:	UPDATE BINARY	
220	:	UPDATE RECORD	
242	:	STATUS	
<fileId>	integer	-	identifier of an elementary data file on UICC; mandatory for every command except STATUS
<P1>	integer	0	parameter passed on to the UICC; it is mandatory for every command except GET RESPONSE and STATUS
Value:			
0÷255	:	parameter P1 passed on to the UICC in a command APDU	
<P2>	integer	0	parameter passed on to the UICC; it is mandatory for every command except GET RESPONSE and STATUS
Value:			
0÷255	:	parameter P2 passed on to the UICC in a command APDU	
<P3>	integer	0	parameter passed on to the UICC; it is mandatory for every command except GET RESPONSE and STATUS
Value:			

	0÷255	:	parameter P3 passed on to the UICC in a command APDU
<data>	string	-	information to be read from UICC or written to the UICC (hexadecimal character format).

Additional info:

▶▶ Response data fields:

Name	Type	Default	Description
<sw1>	integer	-	information from the UICC about the execution of the actual command (successful or failed)
<sw2>	integer	-	information from the UICC about the execution of the actual command (successful or failed)
<response>	hex	-	on a successful completion of the previously issued command it shows the response data. It is not returned after a successful UPDATE BINARY or UPDATE RECORD command



AT+CRSM=?

Test command returns the **OK** result code



Read binary, ICCID(2FE2)

AT+CRSM=176,12258,0,0,10
+CRSM: 144,0,982850702001107686F4
OK

Read record, ADN(6F3A)

AT+CRSM=178,28474,1,4,40
+CRSM: 144,0,42434A554EFFFFFFFFFFFFFFFFFFFFFFFF06811056789282FFFFFFFFFFFFFFFF
OK

Update Binary, KcGPRS(6F52)

AT+CRSM=214,28539,0,0,8,C69018C7958C87
+CRSM: 144,0
OK

Update Record, ADN(6F3A)

AT+CRSM=220,28474,9,4,30,657469FF
FFFFFFFFFFFF
+CRSM: 144,0
OK

Status, FPLMN(6F7B)

AT+CRSM=242,28539
+CRSM:144,0,623C820238218410A0000000871002FFFFFFFF89040300FFA51180013181030
10A3282011E8304000030E08A01058B032F0609C6099001C0830101830181
OK

3.8.11. AT+CSIM - Generic SIM Access

This command sends a generic command to the UICC.



- [1] 3GPP TS 11.11
- [2] 3GPP TS 31.101
- [3] 3GPP TS 31.102

SIM Presence	Setting saved	Can be aborted	MAX timeout	SELINT
Required	No	No	-	2



AT+CSIM=<length>,<command>

Set command transmits to the MT the <command>, it then shall send as it is to the UICC. As response to the command, MT sends back the actual UICC <response> to the TA as it is. The response message of the command is in the format:

+CSIM: <length>,<response>

Error case:

+CME ERROR: <err>

The response messages parameters are described in the Additional info section.

Parameters:

Name	Type	Default	Description
<length>	integer	-	characters number of the <command> sent to UICC (two times the actual length of the command)
<command>	string	-	command passed on by the MT to the UICC in the format as described in standard [1] or [2] (hexadecimal character format, refer to +CSCS)

Additional info:

- ▶▶ List of the meaning of the response messages parameters.

Name	Type	Default	Description
<length>	integer	-	characters number of the <response> sent to TE (two times the actual length of the response)
<response>	string	-	response to the command passed on by the UICC to the TE in the format as described in standard [1] or [2] (hexadecimal character format)
<err>	string	-	error values (numeric format followed by verbose format)



AT+CSIM=?

Test command returns the **OK** result code.



AT+CSIM=<lock>

This special form of the command has no effect and is kept only for backward compatibility.

Parameters:

- <lock>=1 locking of the interface
- <lock>=0 unlocking of the interface



- 2G SIM, see standard [1]:
 STATUS
AT+CSIM=10,A0F2000016
+CSIM:48,"000002A87F20020000000000099300220800838A838A9000"
OK

- SELECT EF 6F07
AT+CSIM=14,A0A40000026F07
+CSIM: 4,"9F0F"
OK

- GET RESPONSE
AT+CSIM=10,A0C000000F
+CSIM: 34,"00000096F0704001A001A010200009000"
OK

- SELECT EF 6F30
AT+CSIM=14,A0A40000026F30
+CSIM: 4,"9F0F"
OK

- READ BINARY
AT+CSIM=10,A0B00000FC
+CSIM:508,"FFFFFF1300831300901300541300301300651300381300801301801
3000113110913013013009813007713005913004313008113009513014013002313
0016330420130041FFFFFFFFF21436542F41922F28822F201FFFFFFFFFFFFF
FF
FF
FF
FF
FF
FF
FF
FFFFFFFFFFFFFFFFFFFFFFFF9000"
OK

3.8.12. AT+CCHO - Open Logical Channel

Open Logical Channel



3GPP TS 31.101

SIM Presence	Setting saved	Can be aborted	MAX timeout	SELINT
Required	No	No	-	2



AT+CCHO=<dfname>

Execution of the command causes the MT to return <sessionId> to allow the TE to identify a channel that is being allocated by the currently selected UICC, which is attached to ME.

The currently selected UICC will open a new logical channel; select the application identified by the <dfname> received with this command and return a <sessionId> as the response.

The ME shall restrict the communication between the TE and the UICC to this logical channel.

The response message of the command is in the format:

+CCHO: < sessionId >

The <sessionId> is described in the Additional info section.

Error case:

+CME ERROR: <err>

Parameter:

Name	Type	Default	Description
<dfname>	string	-	all selectable applications in the UICC are referenced by a DF name coded on 1 to 16 bytes (hexadecimal character format; refer +CSCS).

Additional info:

▶▶ <sessionId> returned by the **+CCHO** command.

Name	Type	Default	Description
<sessionId>	integer	-	session Id to be used to target a specific application on the smart card (e.g. (U)SIM, WIM, ISIM) using logical channels mechanism. Session Id is used when sending commands with Restricted UICC Logical Channel access +CRLA , or Generic UICC Logical Channel access +CGLA commands.

-
-  The logical channel number is contained in the CLASS byte of an APDU command, thus implicitly contained in all APDU commands sent to a UICC.
In this case it will be up to the MT to manage the logical channel part of the APDU CLASS byte and to ensure that the chosen logical channel is relevant to the **<sessionId>** indicated in the AT command. Refer to 3GPP TS 31.101.
-

**AT+CCHO=?**

Returns the **OK** result code.

3.8.13. AT+CCHC - Close Logical Channel

Close a communication session.



3GPP TS 31.101

SIM Presence	Setting saved	Can be aborted	MAX timeout	SELINT
Required	No	No	-	2



AT+CCHC=<sessionId>

Set command asks the ME to close a communication session with the active UICC. The ME shall close the previously opened logical channel. The TE will no longer be able to send commands on this logical channel. The UICC will close the logical channel when receiving this command.

Error case:

+CME ERROR: <err>

Parameter:

Name	Type	Default	Description
<sessionId>	integer	-	a session Id to be used to target a specific application on the smart card (e.g. (U)SIM, WIM, ISIM) using logical channels mechanism. <sessionId> is returned by the +CCHO command.



AT+CCHC=?

Test command returns the **OK** result code.

3.8.14. AT+CGLA - Generic UICC Logical Channel Access

This command is used to control the currently selected UICC on the TE.



- [1] 3GPP TS 11.11
- [2] 3GPP TS 31.101
- [3] 3GPP TS 31.102

SIM Presence	Setting saved	Can be aborted	MAX timeout	SELINT
Required	No	No	-	2



AT+CGLA=<sessionId>,<length>,<command>

Set command transmits to the MT the **<command>** it then shall send as it is to the selected UICC. In the same manner the UICC **<response>** shall be sent back by the MT to the TA as it is. This command allows a direct control of the currently selected UICC by a distant application on the TE. The TE shall then take care of processing the received UICC information. The response of the command is in the format:

+CGLA: <length>,<response>

Error case:

+CME ERROR: <err>

The response messages parameters are described in the Additional info section.

Parameters:

Name	Type	Default	Description
<sessionId>	integer	-	this parameter is the identifier of the session to be used in order to send the APDU commands to the UICC. It is mandatory to send commands to the UICC when targeting applications on the smart card using a logical channel other than the default channel (channel "0"). <sessionId> is returned by the +CCHO command.
<length>	integer	-	characters number of the <command> sent to UICC (two times the actual length of the command)
<command>	string	-	command passed on by the MT to the UICC in the format as described in standard [1] or [2] (hexadecimal character format; refer to +CSCS).

Additional info:

- ▶▶ List of the meaning of the response messages parameters.

Name	Type	Default	Description
<length>	integer	-	characters number of the <response> sent to TE (two times the actual length of the response)

<response>	string	-	response to the command passed on by the UICC to the TE in the format as described in standard [1] or [2] (hexadecimal character format)
<err>	string	-	error values (numeric format followed by verbose format)

**AT+CGLA=?**

Test command returns the **OK** result code.

3.8.15. AT#VSIMSETPROF - Set Virtual SIM profile

This command selects and activates a Virtual SIM profile.

SIM Presence	Setting saved	Can be aborted	MAX timeout	SELINT
Not required	Auto	No	-	2



AT#VSIMSETPROF=<profilid>

Execution command selects and activates a Virtual SIM profile or deactivates the Virtual SIM profile and instructs the device to use the UICC, using the unconditional activation (i.e. without any possibility to fall back).

Parameter:

Name	Type	Default	Description
<profilid>	integer	0	indicates the profile identifier.

Values:

- 0 : the profile 0 represents the UICC
- 1 : refer to the secured storage table that includes all the subscription data



AT#VSIMSETPROF?

Read command reports the current value of parameter in the format:

#VSIMSETPROF: <profilid>



AT#VSIMSETPROF=?

Test command reports the supported range of values for the input parameter.

3.8.16. AT+ICCID - Read ICCID

Execution command reads on SIM the Integrated Circuit Card Identification (ICCID). It is the card identification number that provides a unique identification number for the SIM.

SIM Presence	Setting saved	Can be aborted	MAX timeout	SELINT
Not required	No	No	-	2



AT+ICCID

The command returns the following message:

```
+ICCID: <ICCID>
```



AT+ICCID=?

Test command returns the **OK** result code.



AT#CCID

```
#CCID: 89861109091740011006  
OK
```

3.9. SIM Toolkit

3.9.1. AT#STIA - SIM/USIM Toolkit Interface Action

The SIM/USIM Application Toolkit (SAT/USAT) provides an interface to the applications existing in the SIM/USIM device. The module must support the mechanisms required by the SIM/USIM applications.



- [1] 3GPP TS 23.038
- [2] 3GPP TS 31.111
- [3] Telit SIM/USIM Application Toolkit Application Note

SIM Presence	Setting saved	Can be aborted	MAX timeout	SELINT
Required	Specific profile	No	-	2



AT#STIA=[<mode>[,<timeout>]]

Set command is used to enable/disable the SIM/USIM Application Toolkit (SAT/USAT). In addition, the command can enable the URCs sending.

Parameters:

Name	Type	Default	Description
<mode>	integer	1	enables/disables SAT/USAT.

In addition, <mode> parameter enables the:

- **#STN** URCs notifying the user that the SIM/USIM application has issued a proactive command. Some proactive commands require a user response
- **#STN** URCs that are the SIM/USIM device responses concerning actions initiated by the user, refer to Additional info section.

If <mode>=2, the URC format depends on the <cmdType> as described in the Additional info sections. For <cmdType>, and all other URC parameters refer to **#STGI** command. The <mode> parameter values are listed below.

Values:

- 0 : disable SAT/USAT
- 1 : enable SAT/USAT without #STN URC
- 2 : enable SAT/USAT and extended #STN URC
- 3 : enable SAT/USAT and reduced #STN URC
- 17 : enable SAT/USAT without #STN URC and the alphabet used
- 18 : enable SAT/USAT, extended #STN URC, and the alphabet used
- 19 : enable SAT/USAT, reduced #STN URC, and the alphabet used
- 33 : enable SAT/USAT without #STN URC and the UCS2 alphabet used
- 34 : enable SAT/USAT, extended #STN URC, and the UCS2 alphabet used
- 35 : enable SAT/USAT, reduced #STN URC, and the UCS2 alphabet used

<timeout>	integer	2	When an ongoing proactive command, requiring a user response, is not answered before <timeout> minutes, it is automatically aborted. In this case, the terminal response from the module is either "ME currently unable to process command" or, if applicable, "No response from user". In addition, the following URC is sent on the AT interface. For parameter meaning of the URC refer to Unsolicited fields section. #STN:<cmdTerminateValue>
------------------------	---------	---	---

Follows the **<timeout>** range.

Value:

1,2 : timeout expressed in minutes

Additional info:

- ▶▶ **<mode>=3**, the URC has the following reduced format: **#STN: <cmdType>**

- ▶▶ **<mode>=2**, and **<cmdType>=1** (REFRESH proactive command), the URC has the following extended format:
#STN: 1,<refreshType>

- ▶▶ **<mode>=2**, and **<cmdType>=5** (SET UP EVENT LIST proactive command), the URC has the following extended format:
#STN: 5[,<eventListMask>]

- ▶▶ **<mode>=2**, and **<cmdType>=16** (SET UP CALL proactive command), the URC has the following extended format:
#STN: 16,<cmdDetails>,[<confirmationText>],<calledNumber>

- ▶▶ **<mode>=2**, and one of the following proactive command:
 - <cmdType>=17** (SEND SS)
 - <cmdType>=18** (SEND USSD)
 - <cmdType>=19** (SEND SHORT MESSAGE)
 - <cmdType>=20** (SEND DTMF)
 - <cmdType>=32** (PLAY TONE)

Here are the commands that can be executed only if **AT#STTA=1** has been previously set

 - <cmdType>=52** (RUN AT COMMAND)
 - <cmdType>=64** (OPEN CHANNEL)
 - <cmdType>=65** (CLOSE CHANNEL)
 - <cmdType>=66** (RECEIVE DATA)
 - <cmdType>=67** (SEND DATA)

the URC has the following extended format:

#STN: <cmdType>[,<alphaIdentifier>]

If **<cmdType>=19** (SEND SHORT MESSAGE proactive command) fails, the **#STN: 119** URC is sent to the module.

- ▶▶ **<mode>=2**, and **<cmdType>=33** (DISPLAY TEXT proactive command), the URC is sent if allowed by SIM/USIM, the extended format is:
#STN: 33[,<cmdDetails>[,<alphaIdentifier>]]
 If bit 7 of **<cmdDetails>=1**, the response with the **#STSR** command is required.

- ▶▶ **<mode>=2**, and **<cmdType>=34** (GET INKEY proactive command), the URC has the following extended format:
#STN: 34,<cmdDetails>,<text>

- ▶▶ **<mode>=2**, and **<cmdType>=35** (GET INPUT proactive command), the URC has the following extended format:
#STN: 35,<cmdDetails>,<text>,<responseMin>,<responseMax>[,<defaultText>]

- ▶▶ **<mode>=2**, and **<cmdType>=36** (SELECT ITEM proactive command), the URC has the following extended format:
 the first line of output is:
#STN: 36,<cmdDetails>,<numOfItem>[,<titleText>]<CR><LF>
 one line follows for every item, repeated **<numOfItems>** times:
#STN: 36,<itemId>,<itemText>[,<nextActionId>]

- ▶▶ **<mode>=2**, and **<cmdType>=37** (SET UP MENU proactive command), the URC has the following extended format:
 the first line of output is:
#STN: 37,<cmdDetails>,<numOfItem>,<titleText><CR><LF>
 one line follows for every item, repeated for **<numOfItems>**:
#STN: 37,<itemId>,<itemText>[,<nextActionId>]

- ▶▶ **<mode>=2**, and **<cmdType>=40** (SET UP IDLE MODE TEXT proactive command), the URC has the following extended format:
#STN: 40[,<idleModeTextString>]

- ▶▶ This Additional info section deals with the action initiated by the user (no proactive commands activated by the SIM/USIM device).
 If the call control or SMS control facility present in the SIM/USIM device is activated, when the user application makes an outgoing call, or sends a SS or USSD, or a SMS, the following **#STN** URC could be sent to indicate whether the outgoing call has been accepted, rejected or modified by the SIM, or if the SMS service center address or destination has been changed. For parameters meaning refer to Unsolicited fields section.
#STN:
<cmdControlResponse>,<Result>[,<alphaIdentifier>[,<Number>[,<MODestAddr>]]]

Unsolicited fields:

Name	Type	Description
<cmdTerminateValue>	integer	is defined as <cmdType> + terminate offset. Terminate offset = 100
<cmdControlResponse>	integer	response of the SIM/USIM device Values: 150 : SMS control response 160 : call/SS/USSD response
<Result>	integer	identify the result of the Call or SMS control performed by SIM/USIM device Values: 0 : Call/SMS not allowed 1 : Call/SMS allowed 2 : Call/SMS allowed with modification
<alphaIdentifier>	string	optional text provided by the SIM/USIM device in ASCII format
<Number>	string	Called number, Service Center Address or SS String in ASCII format
<MODestAddr>	string	MO destination address in ASCII format

- The settings are saved on user profile and available on following reboot. SIM/USIM Toolkit activation/deactivation is only performed at power on according to the saved setting.
- If **AT#ENS=1**, the <mode> parameter is set to 2.
- Just one instance at a time, the one which first issued **AT#STIA=<mode>** (with <mode> not equal to 0), is allowed to issue SAT/USAT commands, and this is valid till the same instance issues **AT#STIA=0**. After reboot, SAT/USAT can be used on another instance.



AT#STIA?

Read command can be used to get information about the SAT/USAT interface. The message format is:

#STIA: <state>,<mode>,<timeout>,<SatProfile>

Additional info:

- ▶▶ Returned parameters.

Name	Type	Default	Description
<state>	integer	0	state of the sending of the SET UP MENU proactive command (37)

Values:

- 0 : SIM/USIM has not sent the SET UP MENU proactive command (37)
- 1 : SIM/USIM has sent the SET UP MENU proactive command (37)

<mode>	integer	-	refer to Set section
<timeout>	integer	-	refer to Set section
<SatProfile>	string	-	SAT/USAT Terminal Profile. Is the list of SIM/USIM Application Toolkit facilities supported by the ME. The profile cannot be changed by the TA.

-  In SAT/USAT applications an SMS message is usually sent to the network provider containing service requests, e.g. to send the latest news. The provider returns a message with the requested information. Before activating SAT/USAT, it is recommended to set the SMS text mode with the **AT+CMGF=1** command and enable URC for incoming SMS messages with **+CNMI** command.



AT#STIA=?

Test command returns the range of available values for the parameters **<mode>** and **<timeout>**.

3.9.2. AT#STGI - SIM Toolkit Get Information

The **#STGI** command interfaces to the SIM/USIM Application Toolkit to get information on the ongoing *proactive command*.



3GPP TS 31.111
Telit SIM/USIM Application Toolkit Application Note

SIM Presence	Setting saved	Can be aborted	MAX timeout	SELINT
Not required	No	No	-	2



AT#STGI=[<cmdType>]

Set command gets parameters of the ongoing *proactive command*. The command can be used after the reception of the **#STN: <cmdType>** URC. If no proactive command is ongoing, **#STGI** returns an **ERROR** message.

Parameter:

Name	Type	Default	Description
<cmdType>	integer	N/A	proactive command code. For each proactive command listed below, its #STGI response format is described in the Additional info sections.

Values:

- 1 : REFRESH
- 5 : SET UP EVENT LIST
- 16 : SET UP CALL
- 17 : SEND SS
- 18 : SEND USSD
- 19 : SEND SHORT MESSAGE
- 20 : SEND DTMF
- 32 : PLAY TONE
- 33 : DISPLAY TEXT
- 34 : GET INKEY
- 35 : GET INPUT
- 36 : SELECT ITEM
- 37 : SET UP MENU
- 40 : SET UP IDLE MODE TEXT

Additional info:

- ▶▶ <cmdType>=1 (REFRESH proactive command)
#STGI response format:
#STGI: 1,<refreshType>

Name	Type	Default	Description
------	------	---------	-------------

<refreshType>	integer	N/A	identifies the refresh type
----------------------------	---------	-----	-----------------------------

Values:

- 0 : SIM Initialization and Full File Change Notification
 - 1 : File Change Notification
 - 2 : SIM Initialization and File Change Notification
 - 3 : SIM Initialization
 - 4 : SIM Reset
 - 5 : NAA Application Reset
 - 6 : NAA Session Reset
 - 7 : Steering of Roaming
 - 8 : Steering of Roaming WLAN
-

▶▶ **<cmdType>=5** (SET UP EVENT LIST proactive command)

#STGI response format:

#STGI: 5,<eventListMask>

Name	Type	Default	Description
<eventListMask>	hex	N/A	identifies the list of events to monitor. The <eventListMask> (two bytes long) is a bit mask where each bit, when set, indicates that the corresponding event must be monitored (e.g. if <eventListMask> is 0x0001, it means that MT call must be monitored). <ul style="list-style-type: none"> • bit 0 = MT call • bit 1 = Call connected • bit 2 = Call disconnected • bit 3 = Location status • bit 4 = User activity • bit 5 = Idle screen available • bit 6 = Card reader status (if class "a" is supported) • bit 7 = Language selection • bit 8 = Browser Termination (if class "c" is supported) • bit 9 = Data available (if class "e" is supported) • bit 10 = Channel status (if class "e" is supported) • bits 11 - 15 = reserved for future use

Value:

0x0001÷0x01FF : mask

▶▶ **<cmdType>=16** (SET UP CALL proactive command)

#STGI response format:

#STGI: 16,<cmdDetails>,[<confirmationText>],<calledNumber>

Name	Type	Default	Description
<cmdDetails>	integer	N/A	identifies the command details
Values:			
0	:	set up call, but only if not currently busy on another call	
1	:	set up call, but only if not currently busy on another call, with redial	
2	:	set up call, putting all other calls (if any) on hold	
3	:	set up call, putting all other calls (if any) on hold, with redial	
4	:	set up call, disconnecting all other calls (if any)	
5	:	set up call, disconnecting all other calls (if any), with redial	
<confirmationText>	string	-	string for user confirmation stage
<calledNumber>	string	-	string containing called numbers

►► This section is dedicated to the following proactive commands:

- <cmdType>=17 (SEND SS)
- <cmdType>=18 (SEND USSD)
- <cmdType>=19 (SEND SHORT MESSAGE)
- <cmdType>=20 (SEND DTMF)
- <cmdType>=32 (PLAY TONE)

#STGI response format:

#STGI: <cmdType>[,<alphalIdentifier>]

Name	Type	Default	Description
<alphalIdentifier>	string	-	optional text provided by the SIM/USIM device in ASCII format

►► <cmdType>=33 (DISPLAY TEXT proactive command)

#STGI response format:

#STGI: 33,<cmdDetails>[,<text>]

Name	Type	Default	Description
<cmdDetails>	hex	N/A	a bit mask where each bit position, according to its value, has a specific meaning: bit 0: 0 - normal priority 1 - high priority bits 1-6: reserved for future use bit 7: 0 - clear message after a delay 1 - wait for user to clear message

Value:

0x00÷0xFF : mask

<text>	string	-	text provided by the SIM/USIM device in ASCII format
---------------------	--------	---	--

▶▶ **<cmdType>=34** (GET INKEY proactive command)

#STGI response format:

#STGI: 34,<cmdDetails>,<text>

Name	Type	Default	Description
<cmdDetails>	hex	N/A	a bit mask where each bit position, according to its value, has a specific meaning: bit 0: 0 - digits only (0-9, *, # and +) 1 - alphabet set bit 1: 0 - SMS default alphabet (GSM character set) 1 - UCS2 alphabet bit 2: 0 - character sets defined by bit 0 and bit 1 are enabled 1 - character sets defined by bit 0 and bit 1 are disabled and the "Yes/No" response is requested bits 3-6: 0 bit 7: 0 - no help information available 1 - help information available

Value:

0x00-0x87 : mask

<text>	string	-	string as prompt for test
---------------------	--------	---	---------------------------

▶▶ **<cmdType>=35** (GET INPUT proactive command)

#STGI response format:

#STGI: 35,<cmdDetails>,<text>,<responseMin>,<responseMax>[,<defaultText>]

Name	Type	Default	Description
<cmdDetails>	hex	N/A	a bit mask where each bit position, according to its value, has a specific meaning: bit 0: 0 - digits only (0-9, *, #, and +) 1 - alphabet set bit 1: 0 - SMS default alphabet (GSM character set) 1 - UCS2 alphabet bit 2: 0 - ME may echo user input on the display 1 - user input shall not be revealed in any way. Hidden entry mode is only available when using digit input. In hidden entry mode only characters ('0'-'9', '*' and '#') are allowed.

bit 3:
 0 - user input to be in unpacked format
 1 - user input to be in SMS packed format
bits 4-6:
 0
bit 7:
 0 - no help information available
 1 - help information available

Value:

0x00÷0x8F : mask

<text>	string	-	string as prompt for text
<responseMin>	integer	N/A	minimum number of characters of the user input

Value:

0÷255 : minimum length of user input.

<responseMax>	integer	N/A	maximum number of characters of the user input.
----------------------------	---------	-----	---

Value:

0÷255 : maximum length of user input

<defaultText>	string	-	string supplied as default response text
----------------------------	--------	---	--

▶▶ **<cmdType>=36** (SELECT ITEM proactive command)

#STGI response format:

the first line of output is:

#STGI: 36,<cmdDetails>,<numOfItem>[,<titleText>]<CR><LF>

one line follows for every item, repeated **<numOfItems>** times:

#STGI: 36,<itemId>,<itemText>[,<nextActionId>]

Name	Type	Default	Description
<cmdDetails>	hex	N/A	a bit mask where each bit position, according to its value, has a specific meaning: bit 0: 0 - presentation type is not specified 1 - presentation type is specified in bit 1 bit 1: 0 - presentation as a choice of data values if bit 0 = 1 1 - presentation as a choice of navigation options if bit 0 is 1 bit 2: 0 - no selection preference 1 - selection using soft key preferred bits 3-6: 0

			bit 7: 0 - no help information available 1 - help information available
	Value:		
	0x00÷0x87	:	mask
<numOfItems>	integer	-	number of items in the list
<titleText>	string	-	menu title string
<itemId>	integer	N/A	item identifier
	Value:		
	1÷numOfItems	:	item identifier range
<itemText>	string	-	item title string
<nextActionId>	integer	-	is the code of next proactive command to be issued upon execution of the menu item. If <nextActionId> =0, no next action information available.

- ▶▶ **<cmdType>**=37 (SET UP MENU proactive command)
#STGI response format:
 the first line of output is:
#STGI: 37,<cmdDetails>,<numOfItem>,<titleText><CR><LF>
 one line follows for every item, repeated for **<numOfItems>**:
#STGI: 37,<itemId>,<itemText>[,<nextActionId>]

Name	Type	Default	Description
<cmdDetails>	hex	N/A	a bit mask where each bit position, according to its value, has a specific meaning: bit 0: 0 - no selection preference 1 - selection using soft key preferred bit 1-6: 0 bit 7: 0 - no help information available 1 - help information available
	Value:		
	0x00÷0x81	:	mask
<numOfItems>	integer	-	number of items in the list
<titleText>	string	-	menu title string
<itemId>	integer	N/A	item identifier
	Value:		
	1÷numOfItems	:	item identifier range
<itemText>	string	-	item title

<nextActionId>	integer	-	numerical code of next proactive command type to be issued upon execution of the menu item. If <nextActionId>=0 , no next action information available.
-----------------------------	---------	---	---

▶▶ **<cmdType>=40** (SET UP IDLE MODE TEXT proactive command)

#STGI response format:

#STGI: 40,<idleModeTextString>

Name	Type	Default	Description
<idleModeTextString>	string	-	text provided by the SIM/USIM device in ASCII format

The proactive commands are only those command types that use the AT interface. SAT/USAT commands which are not using the AT interface (not MMI related SAT commands, e.g. PROVIDE LOCAL INFORMATION) are executed without sending any indication to the user.



AT#STGI?

The read command returns the ongoing proactive command and the SAT/USAT state. The message format is:

#STGI: <state>,<cmdType>

Additional info:

▶▶ Returned parameters:

Name	Type	Default	Description
<state>	integer	-	state of the sending of the SET UP MENU proactive command (37), refer to AT#STIA? command
<cmdType>	integer	-	ongoing proactive command code



AT#STGI=?

Test command returns the supported values of parameters **<state>** and **<cmdType>**.



- A typical SAT/USAT session, running on AT interface, starts when the user receives the **#STN: 37** URC. The unsolicited result code must be previously enabled by the **#STIA** command. The **#STN: 37** notifies the user that the main menu of the SIM/USIM Application has been sent to TA, and TA has stored the just received menu. Later, at any time, you can type in the **AT#STGI=37** command to display the main menu of the SIM/USIM Application on TE.

Upon receiving the **#STGI** response, you must enter the **#STSR** command to confirm the execution of the *proactive command* and provide any required user response. In this case, you must enter the **AT#STSR=37,0,x** command to select the **x** item of the SIM/USIM Application menu.

The **#STN: 237** URC indicates that the main menu of the SIM/USIM Application has been removed from TA, and it is no longer available. In this case, **AT#STGI=37** command returns **ERROR** message.

3.9.3. AT#STSR - SIM Toolkit Send Response

This command allows the user to provide a response to confirm the execution of the ongoing proactive command.



3GPP TS 31.111
Telit SIM/USIM Toolkit Application Note

SIM Presence	Setting saved	Can be aborted	MAX timeout	SELINT
Required	No	No	-	2



AT#STSR=[<cmdType>[,<userAction>[,<data>]]]

The set command allows the user to provide a response action to the ongoing proactive command when the action is required by the command itself.

Parameters:

Name	Type	Default	Description
<cmdType>	integer	-	proactive command code, refer to #STGI command to have information on the <cmdType>

<userAction>	integer	0	identify the user action
--------------	---------	---	--------------------------

Values:

- 0 : the user accepts the ongoing proactive command
- 16 : proactive SIM/USIM session terminated by user
- 17 : backward move in the proactive SIM/USIM session requested by the user
- 18 : no response from user
- 19 : help information required by the user
- 20 : USSD/SS Transaction terminated by user
- 32 : TA currently unable to process command
- 34 : user has denied SIM/USIM call setup request
- 35 : user cleared down SIM/USIM call before connection or network release

<data>	string	-	data entered by user, see Additional info section
--------	--------	---	---

Additional info:

▶▶ <data> parameter is used according to <cmdType>, and when <userAction>=0:

- <cmdType>=34 (GET INKEY proactive command)
<data> contains the key pressed by the user. The character set is selected by +CSCS command.

If the ongoing proactive command requires to the user a binary choice (yes/no), the valid content of <data> is:

- "Y" or "y" (positive answer) and "N" or "n" (negative answer) for "IRA", "8859-1", "PCCP437" character sets

- "0079" or "0059" (positive answer) and "006E" or "004E" (negative answer) for UCS2 alphabet

The ongoing proactive command to require a binary choice sets bit 2 of the **<cmdDetails>** parameter to 1, see **#STGI** command.

- **<cmdType>=35** (GET INPUT proactive command).
<data> contains the string of characters entered by the user.
- **<cmdType>=36** (SELECT ITEM proactive command).
<data> contains the item identifier selected by the user.

 **<userAction>=0** is used, for example, to

- accept a call when the ongoing proactive command is SET UP CALL, **<cmdType>=16**
- start a connection when the ongoing proactive command is OPEN CHANNEL, **<cmdType>=64**

 Use of icons is not supported. All icon related actions will respond with no icon available.



AT#STSR?

The read command returns the ongoing proactive command and the SAT/USAT interface state. The format message is:

#STSR: <state>,<cmdType>

If there is no ongoing proactive command, an **ERROR** message is returned.

Additional info:

- ▶▶ Returned parameters.

Name	Type	Default	Description
<state>	integer	-	state of the sending of the SET UP MENU proactive command (37), refer to AT#STIA? command
<cmdType>	integer	-	proactive command code, refer to #STGI command to have information on the <cmdType>



AT#STSR=?

The test command returns the range for the parameters **<state>** and **<cmdType>**.

3.10. Power Down

3.10.1. AT#REBOOT - Module Reboot

Immediate module reboot.

SIM Presence	Setting saved	Can be aborted	MAX timeout	SELINT
Not required	No	No	-	2



AT#REBOOT

Execution command reboots immediately the unit.

It can be used to reboot the system after a remote update of the script in order to have the new one running.

- i** If **#REBOOT** follows an AT command that stores some parameters in NVM, it is recommended to insert a delay of at least 5 seconds before to issue **#REBOOT**, to permit the complete NVM storing.
- i** **#REBOOT** is an obsolete AT command; please refer to **#ENHRST** to perform a module reboot.



AT#REBOOT=?

Test command returns **OK** result code.



- Reboot the module
AT#REBOOT
OK
(the module reboots)

3.10.2. AT#ENHRST - Periodic Reset

Enable or Disable the one shot or periodic unit reset

SIM Presence	Setting saved	Can be aborted	MAX timeout	SELINT
Not required	Auto	No	-	2



AT#ENHRST=<mode>,<delay>

Set commands enables/disables the unit reset after the specified <delay> in minutes



Parameters:

Name	Type	Default	Description
<mode>	integer	0	Enable\Disable mode

Values:

- 0 : disables the unit reset
- 1 : enables the unit reset only one time (one shot reset)
- 2 : enables periodically unit reset

<delay>	integer	-	time interval in minutes after that the unit reboots
---------	---------	---	--

-  The settings are saved automatically in NVM only if old or new <mode> value is 2, i.e. unit set in periodic reset mode. Therefore, any change from 0 to 1 or conversely is not stored in NVM.
-  The command **AT#ENHRST=1,0** causes the immediate module reboot. If it follows an AT command that stores some parameters in NVM, it is strongly recommended to insert a delay of at least 5 sec before issuing it, to permit the complete NVM storing process.



AT#ENHRST?

Read command reports the current parameter settings in the following format:

#ENHRST: <mode>[,<delay>,<remainingTime>]

Additional info:

- ▶▶ Read command parameter for <mode> =1 or 2.

Name	Type	Default	Description
<remainingTime>	integer	-	time in minutes remaining before next reset



AT#ENHRST=?

Test command reports supported range of values for parameters <mode> and <delay>.



Example of **#ENHRST** usage and expected unit behavior.

- **AT#ENHRST=1,60**
...
Module reboots after 60 minutes
- **AT#ENHRST=1,0**
Module reboots immediately
- **AT#ENHRST=2,40**
...
Module reboots after 40 minutes, and after every following power on, it will continue to reboot always after 40 minutes.

3.10.3. AT#SHDN - Software Shutdown

This command turns the module OFF.

SIM Presence	Setting saved	Can be aborted	MAX timeout	SELINT
Not required	No	No	-	2



AT#SHDN

Execution command causes device to detach from the network and shut down. Before definitive shut down an **OK** response is returned.

When issuing the command any previous activity terminated and the device will not respond to any further command.

To turn it on again hardware pin ON/OFF must be tied low.

The maximum time to shut down the device, completely is 25 seconds.



AT#SHDN=?

Test command returns **OK** result code.

3.10.4. AT#FASTSHDN - Fast Shutdown Configuration

This command can be used as a set command to configure a GPIO pin performing a fast shutdown when on it is forced a High to Low level transition. Or can be used as an execute command to force immediately a fast shutdown.

SIM Presence	Setting saved	Can be aborted	MAX timeout	SELINT
Not required	Auto	No	-	2



AT#FASTSHDN[=<enable>[,<GPIO>]]

Parameters:

Name	Type	Default	Description
<enable>	integer	0	enable/disable the fast shutdown execution via a GPIO pin.
Values:			
	0	:	disabled
	1	:	enabled
<GPIO>	integer	-	selects the GPIO to execute the fast shutdown. When the selected <GPIO> pin goes from High to Low level and the <enable> is set to 1, the module execute immediately the fast shutdown.

Additional info:

- ▶▶ The execution command **#FASTSHDN**<CR><LF> forces the module to execute immediately the fast shutdown.

- i** The GPIO pin selected by the **#FASTSHDN** command must be used for this purpose only. If you need to use the selected GPIO pin for different activities, it must be free with the following command:

```
#FASTSHDN=0,<GPIO>
```



AT#FASTSHDN?

Read command reports the currently selected configuration in the format:

```
AT#FASTSHDN: <enable>,<GPIO>
```



AT#FASTSHDN=?

Test command returns the supported range of values for all the parameters.



Enable fast shutdown on GPIO_05

```
AT#FASTSHDN=1,5  
OK
```

```
AT#FASTSHDN?
```

```
#FASTSHDN: 1,5  
OK
```

Force immediate fast shutdown

```
AT#FASTSHDN  
OK
```

3.11. HW and Radio Control

3.11.1. AT#CBC - Battery and Charger Status

This command returns the current Battery and Charger state.

SIM Presence	Setting saved	Can be aborted	MAX timeout	SELINT
Not required	Auto	No	-	2



AT#CBC

Execution command returns the current Battery and Charger state. The response is in the format:

#CBC: <ChargerState>,<BatteryVoltage>

Additional info:

- ▶▶ The response has its fields described below.

Name	Type	Default	Description
<ChargerState>	integer	0	Battery charger state
Values:			
0	:	charger not connected	
1	:	charger connected and charging	
2	:	charger connected and charge completed	
<BatteryVoltage>	integer	-	battery voltage in units of 10 mV: it is the real battery voltage only if charger is not connected; if the charger is connected this value depends on the charger voltage



AT#CBC=?

Test command returns the **OK** result code.

3.11.2. AT#TEMPCFG - Temperature Monitor Configuration

Set command sets the temperature zones shown in Note section. Use #TEMPMON command to get the current internal temperature of the module.



SIM Presence	Setting saved	Can be aborted	MAX timeout	SELINT
Not required	Auto	No	-	2



AT#TEMPCFG=<etlz_clr>,<etlz>,<etlz_act_in>,<otlz_clr>,<otlz>,<otlz_act_in >,<otnz_clr>,<otnz>,<otnz_act_in>,<otuz_clr>,<otuz>,<otuz_act_in>,<etuz_clr>,<etuz>,<etuz_act_in>

Parameters:

Name	Type	Default	Description
<etlz_clr>	integer	-	extreme low zone temperature threshold clear. It has only one valid value: -273 °C. See note.
<etlz>	integer	-	extreme low zone temperature threshold. Default value - 33 °C.
<etlz_act_in>	integer	-	extreme low zone action info. Default value 0.
<otlz_clr>	integer	-	operate low zone temperature threshold clear. Default value -35 °C.
<otlz>	integer	-	operate low zone temperature threshold. Default value - 28 °C.
<otlz_act_in>	integer	-	operate low zone action info. Default value 0.
<otnz_clr>	integer	-	operate normal zone temperature threshold clear. Default value -30 °C.
<otnz>	integer	-	operate normal zone temperature threshold. Default value 95 °C.
<otnz_act_in>	integer	-	operate normal zone action info. Default value 0.
<otuz_clr>	integer	-	operate up zone temperature threshold clear. Default value 93 °C.
<otuz>	integer	-	operate up zone temperature threshold. Default value 100 °C.
<otuz_act_in>	integer	-	operate up zone action info. Default value 3.
<etuz_clr>	integer	-	extreme up zone temperature threshold clear. Default value 98 °C.
<etuz>	integer	-	extreme up zone temperature threshold. It has only one valid value: 528 °C. See note.
<etuz_act_in>	integer	-	extreme up zone action info. Default value 3.

-  The temperature correctly set are saved in a configuration file in the module file system.
-  **etlz_clr**: extreme low zone threshold clear is enforced to have value of -273 °C. Module doesn't operate in such temperature, but this value is logically set to define clearly 'thermal state' to temperatures below -40 °C.
-  **etuz**: extreme up zone threshold is enforced to have value of 528 °C. Module doesn't operate in such temperature, but this value is logically set to define clearly 'thermal state' to temperatures above 100 °C.

-
-  The user must not set `<otnz_act_in>=5` (**Operate normal zone**). This comes to prevent setting "automatic shutdown" by mistake to the normal operating temperature range. Error will be received as a response:

+CME ERROR: operation not supported



AT#TEMPCFG?

Read command reports the current parameter setting for **#TEMPCFG** command in the format:

#TEMPCFG:<etlz_clr>,<etlz>,<etlz_act_in>,<otlz_clr>,<otlz>,<otlz_act_in>,<otnz_clr>,<otnz>,<otnz_act_in>,<otuz_clr>,<otuz>,<otuz_act_in>,<etuz_clr>,<etuz>,<etuz_act_in>



AT#TEMPCFG=?

Test command reports the supported range values for parameters `<x_clr>`, `<x>`, `<x_act_in>`, where "x" is substitute for **etlz**, **otlz**, **otnz**, **otuz**, **etuz**.

Values are:

#TEMPCFG: (-40-100),(-40-100),(0-5)



Thermal mitigation mechanism

After setting new values, the mitigation algorithm operates with them if a power cycle or a **#REBOOT** command is executed. Thermal mitigation mechanism works like this:

- the whole temperature scale is divided into 5 states (zones).
- each measured temperature should belong to a state called the **current state**.

Each state is defined by the following fields:

threshold	upper temperature boundary of the state. Values are in Celsius degrees.
threshold_clr	lower temperature boundary of the state. Values are in Celsius degrees.
action_in	indicator that indicates if an action should be taken or not in the current state .

action_in can be: **none** or **mitigate**, their values are shown in the table below.

none	mitigate	mitigation action
0		no mitigation
	1	data throttling (reducing uplink baud rate)
	2	TX back off (reducing MTPL - Max Tx Power Limit)
	3	emergency calls only
	4	RF OFF. RX and TX circuits automatically disabled (using +CFUN=4)
	5	automatic shutdown. Module is powered OFF

When temperature exceeds the **current state threshold**, the thermal mitigation algorithm searches the next state when this temperature is **lower** than **threshold**. After it finds it, the **current state** is updated to that **state** and then it checks whether **action** is **mitigate**. If yes, then it activates the mitigation according to the **action_in** of the **current state**.

When temperature decreases below **threshold_clr** then it does the same algorithm as above, but in the opposite direction. It searches the next state when this temperature is greater than **threshold_clr**, updates the **current state** to that state, and activates mitigation as described above.

In the state definitions there are the following two rules:

- rule 1: overlap between 2 adjacent states of at least 2 °C, i.e.:
 $\text{thr of state}(x) - \text{thr_clr of state}(x+1) \geq 2$
- rule 2: every state shall have free temperature range which has no part in any overlap range. This range should be at least 2 °C, i.e.:
 $\text{thre_clr state}(x+2) - \text{thre state}(x) \geq 2$

Rule 1 comes to ensure hysteresis in the transition between two states.

Rule 2 comes to ensure a minimum range for a stable state.



Referring to the figure below:

State 0 is **Extreme low zone**

State 1 is **Operate low zone**

State 2 is **Operate normal zone**

State 3 is **Operate up zone**

State 4 is **Extreme up zone**

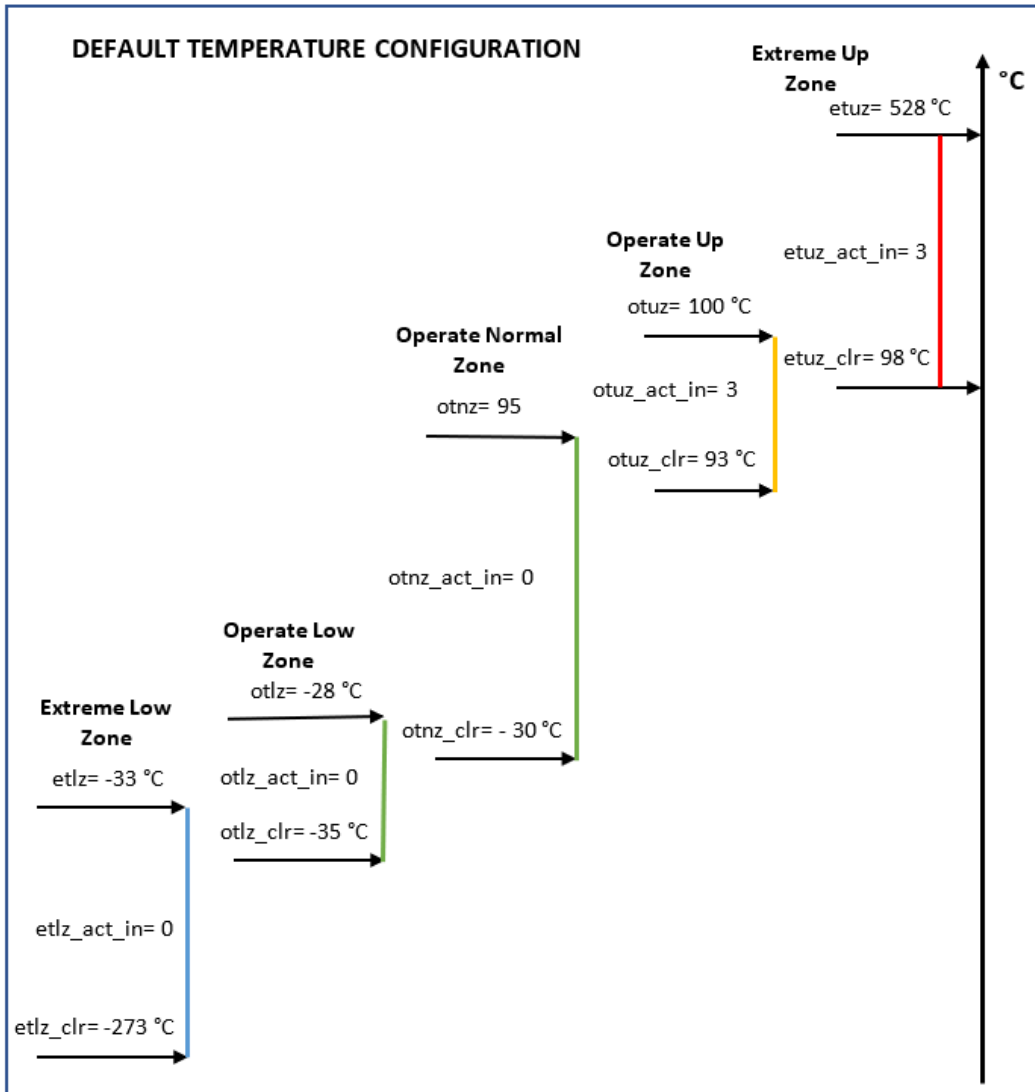



- AT#TEMPCFG= -273,-33,3,-35,-28,2,-30,80,0,78,90,3,88,528,3
OK

Rules 1 and 2 are respected.

zone	thr_clr	thr	action_in
Extreme low zone	-273	-33	3: emergency call only
Operate low zone	-35	-28	2: TX back off
Operate normal zone	-30	80	0: no mitigation
Operate up zone	78	90	3: emergency call only
Extreme up zone	88	528	3: emergency call only

- AT#TEMPCFG=-273,-33,3,-35,-28,2,-30,**80**,0,**79**,90,3,88,528,3
+CME ERROR: operation not supported

Rule 1 is not respected:

(thr of Operate normal zone) - (thr_clr of Operate up zone) = 1 < 2

zone	thr_clr	thr	action_in
Extreme low zone	-273	-33	3: emergency call only
Operate low zone	-35	-28	2: TX back off
Operate normal zone	-30	80	0: no mitigation
Operate up zone	79	90	3: emergency call only
Extreme up zone	88	528	3: emergency call only

- AT#TEMPCFG=-273,-33,3,-35,-28,2,-30,**80**,0,78,90,3,**81**,528,3
+CME ERROR: operation not supported

Rule 2 is not respected:

(thr_clr of Extreme up zone) - (thr of Operate normal zone) = 1 < 2

zone	thr_clr	thr	action_in
Extreme low zone	-273	-33	3: emergency call only
Operate low zone	-35	-28	2: TX back off
Operate normal zone	-30	80	0: no mitigation
Operate up zone	78	90	3: emergency call only
Extreme up zone	81	528	3: emergency call only

3.11.3. AT#GPIO - General Purpose Input/Output Pin Control

Set the value of the general-purpose input/output GPIO pins.

SIM Presence	Setting saved	Can be aborted	MAX timeout	SELINT
Not required	Other	No	-	2



AT#GPIO=[<pin>,<mode>[,<dir>[,<save>]]]

Execution command sets the value of the general purpose GPIO pin.

Parameters:

Name	Type	Default	Description
<pin>	integer	N/A	GPIO pin number. The supported range goes from 1 to Max value that is hardware dependent. Use AT#GPIO=? test command to know Max value.
Value:			
1÷Max	:	GPIO pin identifier	
<mode>	integer	0	sets GPIO pin configuration, its action depends on <dir> value. Refer to Additional info sections.
Value:			
0÷4	:	mode identifier	
<dir>	integer	0	sets the GPIO pin in input, output, or alternate functions. Refer to Additional info sections.
Values:			
0	:	pin set as input	
1	:	pin set as output	
2÷10	:	pin set in alternate functions.	
<save>	integer	0	GPIO pin save configuration. If <save> is omitted, the configuration is stored in NVM only if user set ALTx function.
Values:			
0	:	GPIO pin configuration is not saved	
1	:	GPIO pin configuration is saved	

Additional info:

- ▶▶ This table shows the GPIOs configurations set by **<dir>=0** and **<mode>** values ranging from 0 to 4.

AT#GPIO=<pin>,<mode>,0

<mode>	Description
0	Set INPUT, any internal pull up/pull down removed.
1	Set INPUT, any internal pull up/pull down removed.
2	Read mode, <dir> can be omitted, see Additional info section below
3	Set INPUT, and internal pull up.

4	Set INPUT, and internal pull down.
---	------------------------------------

- This table shows the GPIOs configurations set by `<dir>=1` and `<mode>` values ranging from 0 to 4.

AT#GPIO=<pin>,<mode>,1

<code><mode></code>	Description
0	Set OUTPUT, and GPIO logical value to zero (Low).
1	Set OUTPUT, and GPIO logical value to one (High).
2	Read mode, <code><dir></code> can be omitted, see Additional info section below
3	<code><mode></code> has no meaning.
4	<code><mode></code> has no meaning.

- `<mode>=2` selects the read mode. In read mode, `<dir>` can be omitted.

AT#GPIO=<pin>,2

Name	Type	Default	Description
<code><stat></code>	integer	-	the parameter can be: <ul style="list-style-type: none"> logic value read from pin GPIO<pin> in the case the pin <code><dir></code> is set to input. logic value present in output of the pin GPIO<pin> in the case the pin <code><dir></code> is currently set to output. no meaning value for the pin GPIO<pin> in the case the pin <code><dir></code> is set to alternate function or tristate pull down.

- `<dir>` values from 2 to 9 select an alternate function ranging respectively from ALT1 to ALT5. `<mode>` must be set to 0 or 1 when an alternate function is selected. The table shows the relationship between ALTx, `<dir>` and the name of the associated function.

AT#GPIO=<pin>,0,<dir>

ALTx	Functions names (between quotes) associated to ALTx
ALT1 (<code><dir>=2</code>)	<code>#GPIO</code> maps "STAT_LED" on: GPIO_01 for ME910C1 and NE910C1 families: AT#GPIO=1,0,2 GPIO_08 for ML865C1 family: AT#GPIO=8,0,2 see <code>#SLED</code> to configure the STAT_LED GPIO_x behavior.
ALT2 (<code><dir>=3</code>)	<code>#GPIO</code> or <code>#ALARMPIN</code> can map "ALARM" on one of the available GPIO. Example: AT#GPIO=<pin>,0,3
ALT3 (<code><dir>=4</code>)	<code>#GPIO</code> maps "TEMPMON" on one of the available GPIO. Example: AT#GPIO=<pin>,0,4

ALT4 (<dir>=5)	Reserved
ALT5 (<dir>=6)	Reserved
ALT6 (<dir>=7)	#GPIO maps "FASTSHDN" on one of the available GPIO. Example: AT#GPIO=4,0,7
ALT7 (<dir>=8)	Reserved
ALT8 (<dir>=9)	Reserved
ALT9 (<dir>=10)	Reserved

- i** While using the pins in the alternate function, the GPIO read/write access to that pin is not accessible and must be avoided.



AT#GPIO?

Read command reports, for any GPIO pin, a row showing the current parameters values. Row one shows GPIO pin one, row two shows GPIO pin two, and so on.

```
#GPIO: <dir>,<stat><CR><LF>
#GPIO: <dir>,<stat><CR><LF>
```

...

If GPIO was previously set to <mode>= 3 or 4, the format of the returned message is:

```
#GPIO:<dir>,<stat>,<mode><CR><LF>
#GPIO:<dir>,<stat>,<mode><CR><LF>
```

...



AT#GPIO=?

Test command reports the supported range of values of the command parameters <pin>, <mode>, <dir>, and <save>.



Check the available values ranges

```
AT#GPIO=?  
#GPIO: (1-6),(0-4),(0-1),(0,1)  
OK
```

Set GPIO_3 in output, and set logical value HIGH

```
AT#GPIO=3,1,1  
OK
```

Set GPIO_4 as output, value HIGH a save setting

```
AT#GPIO=4,1,1,1  
#GPIO: 1,0  
OK
```

Report GPIO_3 state

```
AT#GPIO=3,2  
#GPIO: 1,1  
OK
```

Read command

```
AT#GPIO?  
#GPIO: 1,1      GPIO_1 is output, value is HIGH  
#GPIO: 0,0  
#GPIO: 1,1  
#GPIO: 0,0  
#GPIO: 0,1      GPIO_5 is input, value is HIGH  
#GPIO: 1,0  
OK
```

3.11.4. AT#ALARMPIN - Alarm Pin Configuration

This command allows to configure the ALARM Pin.



[1] Hardware User's Guide of the used module

SIM Presence	Setting saved	Can be aborted	MAX timeout	SELINT
Not required	Auto	No	-	2



AT#ALARMPIN=<pin>

Set command allows to set a GPIO pin as ALARM pin.

Configuring a GPIO pin as ALARM pin is equivalent to setting it up with the ALT2 alternate function. Therefore, a GPIO pin can be configured as ALARM pin also through the #GPIO command. To have information on GPIO pins refer to document [1].

Parameter:

Name	Type	Default	Description
<pin>	integer	0	GPIO pin number. Max is the number of GPIO pins provided by the module. For information on the available GPIO pins use the test command.

Values:

0 : no ALARM pin set
1÷Max : GPIO pin number



AT#ALARMPIN?

Read command returns the current value of the parameter <pin> in the format:

#ALARMPIN: <pin>



AT#ALARMPIN=?

Test command returns the supported values of parameter <pin>.

3.11.5. AT#SLED - STAT_LED GPIO Setting

The command configures the behavior of the STAT_LED GPIO.

SIM Presence	Setting saved	Can be aborted	MAX timeout	SELINT
Not required	Other	No	-	2



AT#SLED=<mode>[,<onDuration>[,<offDuration>]]

Set command sets the STAT_LED GPIO behavior. The GPIO pin, so configured, gives information on the module registration status.

To configure a GPIO pin as STAT_LED GPIO, the user must enter **AT#GPIO=x,0,2** command to set the GPIO_x pin as ALT1 alternate function. At the next power ON, the GPIO pin is low until the control reads the saved setting in NVM and configures the GPIO_x as STAT_LED GPIO. Not all GPIOs can be configured as STAT_LED pin. See #GPIO description to know the available GPIOs for this function.

Parameters:

Name	Type	Default	Description
<mode>	integer	2	defines the STAT_LED GPIO behavior.
Values:			
0	:	GPIO tied low	
1	:	GPIO tied high	
2	:	GPIO is handled with specific timings. See Additional info section	
3	:	GPIO is turned ON/OFF alternatively, with period defined by the sum <onDuration> + <offDuration>	
4	:	GPIO is handled with specific timings. See Additional info section	
5	:	status led disabled	
<onDuration>	integer	10	duration of period in which STAT_LED GPIO is tied high while <mode>=3
Value:			
1÷100	:	in tenth of seconds	
<offDuration>	integer	10	duration of period in which STAT_LED GPIO is tied low while <mode>=3
Value:			
1÷100	:	in tenth of seconds	

Additional info:

▶▶ <mode>=2, the timings of STAT_LED GPIO are:

- not registered: always ON
- registered in idle: blinking 1 s ON and 2 s OFF
- registered in idle with power saving: blinking time depends on network condition to minimize power consumption

▶▶ **<mode>=4**, the timings of STAT_LED GPIO are:

- not registered: blinking 0,5 s ON and 0,5 s OFF
- registered in idle: blinking 300 ms ON and 2,7 s OFF
- registered in idle with power saving: blinking time depends on network condition to minimize power consumption



AT#SLED?

Read command returns the STAT_LED GPIO current setting, in the format:

#SLED: <mode>,<onDuration>,<offDuration>



AT#SLED=?

Test command returns the range of available values for parameters **<mode>**, **<onDuration>** and **<offDuration>**.



The setting is saved using the **#SLEDSAV** command.

3.11.6. AT#SLEDSAV - Save STAT_LED GPIO Setting

This command allows to save the current **STAT_LED** GPIO setting.

SIM Presence	Setting saved	Can be aborted	MAX timeout	SELINT
Not required	No	No	-	2



AT#SLEDSAV

Execution command saves the **STAT_LED** GPIO setting in NVM.



AT#SLEDSAV=?

Test command returns **OK** result code.

3.11.7. AT#ADC - Read Analog/Digital Converter Input

This command returns the current voltage value of the specified ADC inputs, expressed in mV.



[1] Hardware User's Guide of the used module

SIM Presence	Setting saved	Can be aborted	MAX timeout	SELINT
Not required	No	No	-	2



AT#ADC=[<adc>,<mode>[,<dir>]]

Execution command reads selected <adc> pin voltage, converts it by baseband internal ADC and prints out the result as shown in Additional info section.

Parameters:

Name	Type	Default	Description
<adc>	integer	1	index of input pin
Value:			
1÷n : input pin index. For the number of available ADCs see document [1]			
<mode>	integer	2	required action
Value:			
2 : query ADC value			
<dir>	integer	0	direction. Its interpretation is currently not implemented.
Value:			
0 : no effect			

Additional info:

►► Format of the message printed out by the execution command:

#ADC:<value>

Name	Type	Default	Description
<adc>	integer	-	pin voltage expressed in mV.



The command returns the last valid measure.



AT#ADC?

Read command reports all pins input voltage in the format:

#ADC:<value>[<CR><LF>#ADC:<value>[...]]



AT#ADC=?

Test command reports the supported range of values of the command parameters **<adc>**, **<mode>** and **<dir>**.

3.11.8. AT#V24CFG - V24 Output Pins Configuration

This command sets the AT commands serial port interface output pins mode.

SIM Presence	Setting saved	Can be aborted	MAX timeout	SELINT
Not required	No	No	-	2



AT#V24CFG=<pin>,<mode>

Set command sets the AT commands serial port interface output pins mode.

Parameters:

Name	Type	Default	Description
<pin>	integer	0	AT commands serial port interface hardware pin

Values:

- 0 : DCD (Data Carrier Detect)
- 1 : CTS (Clear To Send)
- 2 : RI (Ring Indicator)
- 3 : DSR (Data Set Ready)

<mode>	integer	0	AT commands serial port interface hardware pins mode
--------	---------	---	--

Values:

- 0 : AT commands serial port mode: the V24 pins are controlled by the serial port device driver
- 1 : GPIO mode: the V24 output pins can be managed through the AT#V24 command



Changing V24 pins configuration may affect the cellular module functionality set through **+CFUN**.



AT#V24CFG?

Read command returns the current configuration for all the pins (both output and input) in the format:

```
#V24CFG: <pin1>,<mode1>[<CR><LF><CR><LF>
#V24CFG: <pin2>,<mode2>[...]]
```



AT#V24CFG=?

Test command reports supported range of values for parameters <pin>, and <mode>.

3.11.9. AT#V24 - V24 Output Pins Control

This command sets the state of the output pins of the AT commands serial port interface.

SIM Presence	Setting saved	Can be aborted	MAX timeout	SELINT
Not required	No	No	-	2



AT#V24=<pin>[,<state>]

Set command sets the AT commands serial port interface output pins state.

Parameters:

Name	Type	Default	Description
<pin>	integer	0	AT commands serial port interface hardware pin:
Values:			
0	:	DCD (Data Carrier Detect)	
1	:	CTS (Clear To Send)	
2	:	RI (Ring Indicator)	
3	:	DSR (Data Set Ready)	
4	:	DTR (Data Terminal Ready). This is not an output pin: this value is used only for backward compatibility. Trying to set its state raises the result code "ERROR" (not yet implemented)	
5	:	RTS (Request To Send). This is not an output pin: this value is used only for backward compatibility. Trying to set its state raises the result code "ERROR" (not yet implemented)	
<state>	integer	0	State of AT commands serial port interface output hardware pins (0, 1, 2, 3) when pins are in GPIO mode (see AT#V24CFG):
Values:			
0	:	Low state	
1	:	High state	

 If <state> is omitted the command returns the actual state of the pin <pin>.



AT#V24?

Read command returns actual state for all the pins (either output and input) in the format:

```
#V24: <pin1>,<state1>[<CR><LF>
```

```
#V24: <pin2>,<state2>[...]]
```



AT#V24=?

Test command returns the supported values of parameters <pin> and <state>.

3.11.10. AT#I2CWR - Write to I2C

This command is used to send data to an I2C peripheral connected to module.



[1] Hardware User's Guide of the used module

SIM Presence	Setting saved	Can be aborted	MAX timeout	SELINT
Not required	No	No	-	2



AT#I2CWR=<sdaPin>,<sciPin>,<deviceId>,<registerId>,<len>

Execution command sends data to an I2C peripheral connected to module GPIOs. After the writing activity has been accomplished, the GPIOs will not be restored to the original setting. Use **#GPIO** command to see the status of the used GPIOs. To have information on GPIO pins refer to document [1].

Parameters:

Name	Type	Default	Description
<sdaPin>	integer	-	GPIO number for SDA. To know the range use #I2CWR test command.
<sciPin>	integer	-	GPIO number for SCL. To know the range use #I2CWR test command.
<deviceId>	hex	N/A	address of the I2C device (7 bits). The Least Significant Bit is used for read/write command, but in this #I2CWR implementation, it doesn't matter if the LSB is set to 0 or 1. Address must be written in hexadecimal form without 0x. 10 bit address is also supported.
Value:			
0÷3FF : addressing range extended to 10 bit			
<registerId>	hex	N/A	register to write data to
Value:			
0÷FF : value must be written in hexadecimal form without 0x			
<len>	integer	N/A	number of data to send
Value:			
1÷254 : number of data to send			

Additional info:

- ▶▶ After entering the command, the module returns the prompt ">" and waits for the data to send. To complete the operation, send **Ctrl-Z** char (**0x1A** hex); to exit without writing the message send **ESC** char (**0x1B** hex). Data must be written in hexadecimal form.

If data are successfully sent, the response is **OK**, otherwise an error code is reported.

**AT#I2CWR=?**

Test command returns the range of available values for parameters <sdPin>, <scIPin>, <deviceld>, <registerld>, <len>.



Set GPIO_2 as SDA, and GPIO_3 as SCL. Device I2C address is 0x20; 0x10 is the address of the first register where to write I2C data; 14 data bytes will be written starting from register 0x10.

```
AT#I2CWR=2,3,20,10,14
> 00112233445566778899AABBCCDD<ctrl-z>
OK
```

3.11.11. AT#I2CRD - Read from I2C

This command is used to read data from an I2C peripheral connected to module.



[1] Hardware User's Guide of the used module

SIM Presence	Setting saved	Can be aborted	MAX timeout	SELINT
Not required	No	No	-	2



AT#I2CRD=<sdaPin>,<sciPin>,<devicId>,<registerId>,<len>

Execution command reads data from an I2C peripheral connected to module GPIOs. After the reading activity has been accomplished, the GPIOs will not be restored to the original setting. Use #GPIO command to see the status of the used GPIOs. To have information on GPIO pins refer to document [1].

Parameters:

Name	Type	Default	Description
<sdaPin>	integer	-	GPIO number for SDA. To know the range use #I2CRD test command.
<sciPin>	integer	-	GPIO number for SCL. To know the range use #I2CRD test command.
<devicId>	hex	N/A	address of the I2C device (7 bits). The Least Significant Bit is used for read/write command, but in this #I2CCF implementation, it doesn't matter if the LSB is set to 0 or 1. Address must be written in hexadecimal form without 0x. 10 bit address is also supported

Value:

0÷3FF : addressing range extended to 10 bit

<registerId>	hex	N/A	Register to read data from
--------------	-----	-----	----------------------------

Value:

0÷FE : value must be written in hexadecimal form without 0x

<len>	integer	N/A	Number of data to receive <ul style="list-style-type: none"> Data Read from I2C will be dumped in hexadecimal format If data requested are more than data available in the device, dummy data (normally 0x00 or 0xff) will be dumped
-------	---------	-----	--

Value:

1÷254 : number of data to receive



AT#I2CRD=?

Test command returns the range of available values for parameters <sdaPin>, <sciPin>, <devicId>, <registerId>, <len>.



Read 12 bytes from I2C device with address 0x20, starting from register address 0x10. SDA is mapped on GPIO_02, SCL is mapped on GPIO_03.

```
AT#I2CRD=2,3,20,10,12  
#I2CRD: 00112233445566778899AABBCC  
OK
```

3.11.12. AT#I2CCF - Combined Format for I2C Writing and Reading

This command is used to write and read data to/from an I2C device using the I2C Combined Format. The module acts as an I2C master.



[1] Hardware User's Guide of the used module

SIM Presence	Setting saved	Can be aborted	MAX timeout	SELINT
Not required	Auto	No	-	2



AT#I2CCF=<sdaPin>,<scIPin>,<deviceld>,<lenwr>,<lenrd>

The module, as master, transmits data to the slave and then, reads data from it through two GPIOs. Transfer direction is changed when writing section is ended. After the write/read activity has been accomplished, the GPIOs will not be restored to the original setting. Use #GPIO command to see the status of the used GPIOs. To have information on GPIO pins refer to document [1].

Parameters:

Name	Type	Default	Description
<sdaPin>	integer	-	GPIO number for SDA. To know the range use #I2CCF test command.
<scIPin>	integer	-	GPIO number for SCL. To know the range use #I2CCF test command.
<deviceld>	hex	N/A	address of the I2C device (7 bits). The Least Significant Bit is used for read/write command, but in this #I2CCF implementation, it doesn't matter if the LSB is set to 0 or to 1. Address must be written in hexadecimal form without 0x. 10 bit address is also supported.
		Value:	
		0÷3FF	: addressing range extended to 10 bit
<lenwr>	integer	N/A	number of data to write.
		Value:	
		0÷254	: number of data to write.
<lenrd>	integer	N/A	number of data to read.
		Value:	
		0÷254	: number of data to read.

Additional info:

- ▶▶ After entering the command, and if <lenwr> > 0, the module returns the prompt ">" and waits for the data to send. To complete the operation enter **Ctrl-Z** char (**0x1A** hex); to exit without writing the message enter **ESC** char (**0x1B** hex).
Data must be written in hexadecimal form without 0x.
If data are successfully sent, the response is **OK**, otherwise an error code is reported.

**AT#I2CCF=?**

Test command returns the range of available values for parameters **<sdaPin>**, **<sciPin>**, **<deviceld>**, **<lenwr>**, **<lenrd>**.



- Set GPIO_2 as SDA, GPIO_3 as SCL; Device I2C address is 0x20; First is send data 0x0a; after a "RESTART", 4 data bytes are read.

```
AT#I2CCF=2,3,20,1,4
>0a<ctrl-z>
#I2CCF: abcdef12
OK
```

The sequence is the following:
START - 0x20- 0x0a -RESTART - 0X21 - data read 1 -...- data read 4 - STOP

- Set GPIO_2 as SDA, GPIO_3 as SCL; Device I2C address is 0x20; read data:

```
AT#I2CCF=2,3,20,0,2
#I2CCF: abcd
OK
```

The sequence is the following:
START - 0x21- - data read 1 - data read 2 - STOP

3.11.13. AT#TEMPMON - Temperature Monitor

This command is used to retrieve internal temperature information of the module.



[1] Hardware User's Guide of the used module

SIM Presence	Setting saved	Can be aborted	MAX timeout	SELINT
Not required	Auto	No	-	2



AT#TEMPMON=<mod>[,<urcMode>[,<action>[,<hystTime>[,<GPIO>]]]]

Set command sets the internal temperature monitoring mode of the module, reads it, and enables/disables/triggers the presentation of the temperature monitoring message, that can be respectively an URC or an intermediate message according to the selected mode.

#TEMPMEAS: <level>,<value>

The temperature monitoring message parameters are described in the Unsolicited fields section.

Parameters:

Name	Type	Default	Description
<mod>	integer	0	select the temperature monitoring mode.
Values:			
0	:	only if <mod>=0 optional parameters of the command have meaning	
1	:	triggers the measurement of the module internal temperature, reporting the result using the format shown above	
<urcMode>	integer	0	URC presentation mode
Values:			
0	:	disables the presentation of the temperature monitoring URC.	
1	:	enables the presentation of the temperature monitoring URC, whenever the module internal temperature reaches either operating or extreme levels.	
<action>	integer	0	sum of integers, each representing the action to be done whenever the module internal temperature reaches either operating or extreme levels.
Values:			
0	:	no action	
1	:	(01) activating of thermal mitigation according to thermal configuration file, see #TEMPCFG command	
2	:	(10) output pin <GPIO> is tied HIGH when operating temperature bounds are reached; when the temperature is back to normal the output pin <GPIO> is tied LOW. If this <action> is required, it is mandatory to set the <GPIO> parameter too	
3	:	(11) this value contains <action=1> and <action=2>, i.e. activate thermal mitigation and a GPIO indication. If this <action> is required, it is mandatory to set the <GPIO> parameter too.	



4 : same as 2

5÷7 : same as 3

<hystTime>	integer	-	dummy parameter in the range 0..255
<GPIO>	integer	-	GPIO number. Valid range is any GPIO pin as described in #GPIO command. This parameter is needed and required only if <action> 2 or 3 is enabled. To have hardware information about GPIO refer to document [1].

Unsolicited fields:

Name	Type	Description
<level>	integer	threshold level Values: -2 : extreme low zone, see #TEMPCFG command -1 : operate low zone, see #TEMPCFG command 0 : operate normal zone, see #TEMPCFG command 1 : operate up zone, see #TEMPCFG command 2 : extreme up zone, see #TEMPCFG command
<value>	integer	current temperature expressed in Celsius degrees.

-  **#TEMPCFG** command sets the thresholds levels. See there, also the description of the thermal mitigation configuration and its mechanism.
-  Last **<action>** and **<GPIO>** settings are saved in the file system.



AT#TEMPMON?

Read command reports the current parameter settings for the command in the format:

#TEMPMON: <urcMode>,<action>[,<hystTime> [,<GPIO>]]



AT#TEMPMON=?

Test command reports the supported range of values for parameters **<mod>**, **<urcMode>**, **<action>**, **<hystTime>**, and **<GPIO>**.

3.11.14. AT#TESTMODE - Test Mode Configuration

Set module in test mode for configuring and testing the POWER level.

SIM Presence	Setting saved	Can be aborted	MAX timeout	SELINT
Not required	Auto	No	-	2



AT#TESTMODE=<cmd>

The command allows setting module in not signaling mode. The functionality has to be first activated by sending **AT#TESTMODE="TM"** and **AT#TESTMODE="INIT4G"**, which set the module in Test Mode. Only after this set, **AT#TESTMODE** can be used with the other allowed commands. To exit from Test Mode and go back to Operative Mode, the command **AT#TESTMODE="OM"** must be sent.

Parameter:

Name	Type	Default	Description
<cmd>	string	N/A	Current command as quoted string in the format: "<cmd>"

PL4G command must be followed by the value of the **pwr** transmission:
AT#TESTMODE="PLG4 -100"

CH4G command must be followed by the **ch** channel and **bw** bandwidth:
AT#TESTMODE="CHG4 20000 3"

Values:

- "TM" : forces the module in Test Mode
- "OM" : forces the module in Operative Mode
- "INIT4G" : 4G command: allows to enter definitively in Test Mode for 4G operations
- "TX4G" : 4G command: starts the 4G module transmission if Radio is initialized
- "PL4G pwr" : 4G command: change the 4G transmission power. Range: -400 ÷ 200 in tenth of dBm
- "CH4G ch bw" : 4G command: changes the 4G earfcn ul or dl for transmitting or receiving, and sets the bandwidth
- "RL4G" : 4G command: provides the Rx power level in tenth of dBm for the channel set with "CH4G" command.
- "ESC" : stop the TX transmission
- "DEINIT4G" : 4G command: de-initialize Radio for 4G transmission

Additional info:





LTE_EARFCN_UL	Band
18000 - 18599	1
18600 - 19199	2
19200 - 19949	3

19950 - 20399	4
20400 - 20649	5
21450 - 21799	8
23010 - 23179	12
23180 - 23279	13
23730 - 23849	17
24000 - 24149	19
24150 - 24449	20
24450 - 24599	21
26690 - 27039	26
27210 - 27659	28

LTE_EARFCN_DL	Band
0 - 599	1
600 - 1199	2
1200 - 1949	3
1950 - 2399	4
2400 - 2649	5
3450 - 3799	8
5010 - 5179	12
5180 - 5279	13
5730 - 5849	17
6000 - 6149	19
6150 - 6449	20
6450 - 6599	21
8690 - 9039	26
9210 - 9659	28

<bw>	Band (MHz)
0	1,4
1	3,0
2	5,0

-  Bands support varies depending on the product
-  It is not possible to read RX power level during an ongoing TX



AT#TESTMODE?

Read command reports the currently selected **<command>** in the format:

#TESTMODE: <testModeStatus>

Additional info:

- ▶▶ Parameter meaning:

Name	Type	Default	Description
<testModeStatus>	integer	0	status

Values:

0 : module is in Operative Mode
1 : module is in Test Mode



AT#TESTMODE=?

Test command returns the **OK** result code



Set Test Mode

AT#TESTMODE="TM"

OK

Reboot

Initialize Test Mode for 4G operations

AT#TESTMODE="INIT4G"

OK

set B2 with 10MHz bandwidth, download

AT#TESTMODE="CH4G 900 3"

OK

read power level

AT#TESTMODE="RL4G"

-98 dBm

OK

set B4 with 5MHz bandwidth, upload

AT#TESTMODE="CH4G 20000 2"

OK

start transmission

AT#TESTMODE="TX4G"

OK

stop transmission

AT#TESTMODE="ESC"

OK

exit from Test Mode

AT#TESTMODE="OM"

OK

Reboot

3.12. Mobile Broadband

3.12.1. Ethernet Control Mode (ECM)

3.12.1.1. AT#ECM - Ethernet Control Model Setup

This command sets up an Ethernet Control Model (ECM) session.



SIM Presence	Setting saved	Can be aborted	MAX timeout	SELINT
Not required	Auto	No	-	2



AT#ECM=<Cid>,<Did>

Parameters:

Name	Type	Default	Description
<Cid>	integer	-	context id that will be used by ECM. Refer to test command to know the supported range of values.
<Did>	integer	-	device id, currently limited to 0 (only one device)

-  To enable the ECM session configuration the module must be rebooted.
-  To activate an ECM session a compatible USB configuration has to be set; for details refer to the description of **#USBCFG**.



AT#ECM?

Read command returns the session state in the following format:

```
# ECM: <Did>,<State>
OK
```

Additional info:

- ▶▶ Here are the parameters meaning returned by the read command and not described in the previous sections.

Name	Type	Default	Description
<State>	integer	0	ECM session status.

Values:

- 0 : disabled
- 1 : enabled



AT#ECM=?

Test command returns the range of supported values for all the parameters.

3.12.1.2. AT#ECMD - ECM Shutdown

This command is used to shutdown an Ethernet Control Model (ECM) session.

SIM Presence	Setting saved	Can be aborted	MAX timeout	SELINT
Not required	No	No	-	2



AT#ECMD=<Did>

Parameter:

Name	Type	Default	Description
<Did>	integer	N/A	Device id, currently limited to 0 (only one device)

Value:

0 : Device id (currently limited to only one device)



To make active the command the module must be rebooted.



AT#ECMD?

Read command returns the session state in the following format:

#ECM: <Did>,<State>
OK

Additional info:

- ▶▶ Parameter returned by the read command and not described in the previous sections.

Name	Type	Default	Description
<State>	integer	0	State of Ethernet Control Model (ECM) session

Values:

0 : disabled

1 : enable



AT#ECMD=?

Test command returns the range of supported values for <Did>.

3.13. IPEasy

3.13.1. AT#SGACT - PDP Context Activation

This command enables/disables the PDP context activation.

SIM Presence	Setting saved	Can be aborted	MAX timeout	SELINT
Required	No	No	-	2



AT#SGACT=<cid>,<stat>[,<userId>[,<pwd>]]

Execution command is used to activate the specified PDP context, followed by binding data application to the PS network. Also, it is used to deactivate the PDP context and unbind data application from PS network.

Execution command returns a list of IP addresses for the specified context identifiers in the format:

for IP or IPV6 PDP context: **#SGACT: <ipAddr>**

for DUAL STACK IPV4V6 PDP context: **#SGACT: [<ipAddrV4>],[<ipAddrV6>]**

Parameters:

Name	Type	Default	Description
<cid>	integer	-	specifies a particular PDP context definition. To know the range see +CGDCONT command.
<stat>	integer	0	activates/disactivates the PDP context specified
Values:			
0	:	deactivate the context	
1	:	activate the context	
<userId>	string	-	user identifier, used only if the context requires it
<pwd>	string	-	password, used only if the context requires it



Additional info:

▶▶ Meaning of the parameters returned by the command.

Name	Type	Default	Description
<ipAddr>	string	-	ip address ipv4 or ipv6
<ipAddrV4>	string	-	ip address ipv4 (if v4 PDP context activated)
<ipAddrV6>	string	-	ip address ipv6 (if v6 PDP context activated)



Context activation/deactivation returns **ERROR** if there is not any socket associated to it, see **#SCFG**.

-
-  In LTE network, default PDP context (**<cid>=1**) is activated by piggybacking on LTE attach procedure and maintained until detached from network. This command with **<cid>=1** is just binding or unbinding application to the default PDP context.
 -  If the unsolicited result code for obtaining IP address was enabled (urcmode value) using **#SGACTCFG** command, on start up and due to USB enumeration timing the unsolicited may not appear, user should manually use **+CGPADDR** command to see the IP address.
-

**AT#SGACT?**

Read command returns the state of all the contexts that have been defined in the format:

```
#SGACT: <cid1>,<stat1><CR><LF>
```

...

```
#SGACT: <cidn>,<statn>
```

-  Each row in the read command's answer is optional.
-

**AT#SGACT=?**

Test command reports the range for the parameters **<cid>** and **<stat>**.

3.13.2. AT#SGACTAUTH - PDP Context Authentication Type

This command sets the authentication type for IP Easy

SIM Presence	Setting saved	Can be aborted	MAX timeout	SELINT
Required	No	No	-	2



AT#SGACTAUTH=<type>

Set command sets the authentication type for IP Easy, it has effect on the authentication mode used by #SGACT command.

Parameter:

Name	Type	Default	Description
<type>	integer	1	authentication type for IP Easy

Values:

- 0 : no authentication
- 1 : PAP authentication
- 2 : CHAP authentication



AT#SGACTAUTH?

Read command reports the current IP Easy authentication type, in the format:

#SGACTAUTH: <type>



AT#SGACTAUTH=?

Test command returns the supported values for parameter <type>.

3.13.3. AT#SGACTCFG - PDP Automatic Context Activation-Reactivation

This command configures the automatic activation/reactivation of the specified PDP context

SIM Presence	Setting saved	Can be aborted	MAX timeout	SELINT
Required	Auto	No	-	2



AT#SGACTCFG=<cid>,<retry>[,<delay>[,<urcmode>]]

Set command enables/disables the automatic activation/reactivation of the specified PDP context, sets the maximum number of attempts and the delay between an attempt and the next one. The context is automatically activated after every PS attach or after a network PDP context deactivation if at least one IPEasy socket is configured for that context, see #SCFG command.

Parameters:

Name	Type	Default	Description
<cid>	integer	-	PDP context identifier. To know the range see +CGDCONT command.
<retry>	integer	0	specifies the maximum number of context activation attempts in case of activation failure. 0 disables the automatic activation/reactivation of the context. It is the default value if the set command is not used, see Example section.
Value: 1÷15 : number of attempts.			
<delay>	integer	180	specifies the delay in seconds between an attempt and the next one. 180 is the default value if the set command is not used, see Example section.
Value: 180÷3600 : delay in seconds			
<urcmode>	integer	0	URC presentation mode.
Values: 0 : disables URC 1 : enables URC, see Additional info section.			



Additional info:

- ▶▶ <urcmode>=1
enables the URC after an automatic activation/reactivation of the local IP address obtained from the network. It has meaning only if <retry>≠0.
The format of the URC message is:

#SGACT: <ip_address>

Unsolicited field:

Name	Type	Description
<ip_address>	string	local IP address obtained from the network.

-  The URC presentation mode <urcmode> is related to the current AT instance only. Last <urcmode> setting is saved for every instance as extended profile parameter, thus it is possible to restore it even if the multiplexer control channel is released and set up, back and forth.
-  <retry > and <delay> setting are global parameters saved in NVM.
-  If the automatic activation is enabled on a context, then it is not allowed to modify by the command #SCFG the association between the context itself and the socket connection identifier; all the other parameters of command #SCFG are modifiable while the socket is not connected.

**AT#SGACTCFG?**

Read command reports the states of all configured PDP contexts, in the format:

#SGACTCFG: <cid₁>,<retry₁>,<delay₁>, < urcmode >CR><LF>

...

#SGACTCFG: <cid_n>,<retry_n>,<delay_n>,< urcmode >

**AT#SGACTCFG=?**

Test command reports the values ranges of the parameters.



- **AT+CGDCONT=1,"IP","Access_Point_Name"**
OK

```
AT+CGDCONT?  
+CGDCONT: 1,"IP","Access_Point_Name","",0,0  
OK
```

```
AT#SCFG=6,1,300,90,600,50  
OK
```

```
AT#SCFG?  
#SCFG: 1,1,300,90,600,50  
#SCFG: 2,1,300,90,600,50  
#SCFG: 3,1,300,90,600,50  
#SCFG: 4,2,300,90,600,50  
#SCFG: 5,2,300,90,600,50  
#SCFG: 6,1,300,90,600,50  
OK
```

```
AT#SGACTCFG?  
#SGACTCFG: 1,0,180,0  
OK
```

```
AT#SGACTCFG=1,15,3600,1  
OK
```

```
AT#SGACTCFG?  
#SGACTCFG: 1,15,3600,1  
OK
```

Reboot the module

```
AT#SGACTCFG?  
#SGACTCFG: 1,15,3600,0  
OK
```

3.13.4. AT#SGACTCFGEXT - Extended PDP Context Configuration

This command manages the extended configuration of context activation.

SIM Presence	Setting saved	Can be aborted	MAX timeout	SELINT
Required	Auto	No	-	2



AT#SGACTCFGEXT=<cid>,<abortAttemptEnable>[,<unused>[,<unused>[,<unused>]]]

Set command is used to enable new features related to context activation.

Parameters:

Name	Type	Default	Description
<cid>	integer	-	PDP context identifier. To know the range see +CGDCONT command.
<abortAttemptEnable>	integer	0	enables/disables abort during context activation attempt.
Values:			
0 : old behavior: no abort possible while attempting context activation			
1 : abort during context activation attempt is possible by sending a byte on the serial port			
<unused>	mixed	N/A	unused parameter
Value:			
0 : dummy value			
<unused>	mixed	N/A	unused parameter
Value:			
0 : dummy value			
<unused>	mixed	N/A	unused parameter
Value:			
0 : dummy value			

- i** <abortAttemptEnable>=1 takes effect on successive PDP context activation attempt through **#SGACT** command. While waiting for **AT#SGACT=<cid>,1** response, it is possible to abort attempt by sending a byte and get back AT interface control (**NO CARRIER** indication).
- i** If we receive delayed **CTXT ACTIVATION ACCEPT** after abort, network will be automatically informed of our aborted attempt through relative protocol messages (**SM STATUS**) and will also close on its side. Otherwise, if no **ACCEPT** is received after abort, network will be informed later of our PDP state through other protocol messages (routing area update for instance).
- i** The command is not effective while the context is already open.

**AT#SGACTCFGEXT?**

Read command reports the state of all the five contexts, in the format:

```
#SGACTCFGEXT: <cid1>,< abortAttemptEnable1 >,0,0,0<CR><LF>
```

...

```
#SGACTCFGEXT: <cidn>,< abortAttemptEnablen >,0,0,0<CR><LF>
```

**AT#SGACTCFGEXT=?**

Test command reports supported range of values for all parameters.



- See #SGACTCFG command
AT#SGACTCFG?
#SGACTCFG: 1,15,3600,0
OK

AT#SGACTCFGEXT?
#SGACTCFGEXT: 1,0,0,0,0
OK

AT#SGACTCFGEXT=1,1,0,0,0
OK

AT#SGACTCFGEXT?
#SGACTCFGEXT: 1,1,0,0,0
OK

 Reboot the module

AT#SGACTCFGEXT?
#SGACTCFGEXT: 1,1,0,0,0
OK

3.13.5. AT#SCFG - Socket Configuration

The command sets the configuration for the socket.

SIM Presence	Setting saved	Can be aborted	MAX timeout	SELINT
Required	Auto	No	-	2



AT#SCFG=<connId>,<cid>,<pktSz>,<maxTo>,<connTo>,<txTo>

Set command sets the socket configuration parameters.

Parameters:

Name	Type	Default	Description
<connId>	integer	N/A	Socket connection identifier.
Value:			
1÷6	:	Socket connection identifier value	
<cid>	integer	-	PDP context identifier. To know the range see +CGDCONT command.
<pktSz>	integer	300	Packet size in bytes to be used by the TCP/UDP/IP stack for data sending.
Values:			
0	:	select automatically default value	
1÷1500	:	packet size in bytes	
<maxTo>	integer	90	Exchange timeout in seconds (or socket inactivity timeout); if there's no data exchange within this timeout period the connection is closed.
Values:			
0	:	no timeout	
1÷65535	:	timeout	
<connTo>	integer	600	Connection timeout in tenths of seconds. If we cannot establish a connection to the remote within this timeout period, an error is raised.
Values:			
0	:	no timeout	
10÷1200	:	timeout value in hundreds of milliseconds	
<txTo>	integer	50	data sending timeout; data are sent even if they are less than max packet size, after this period. Used for online data mode only.
Values:			
0	:	no timeout	
1÷255	:	timeout in tenths of seconds	
256	:	timeout value of 10 ms	
257	:	timeout value of 20 ms	

258	:	timeout value of 30 ms
259	:	timeout value of 40 ms
260	:	timeout value of 50 ms
261	:	timeout value of 60 ms
262	:	timeout value of 70 ms
263	:	timeout value of 80 ms
264	:	timeout value of 90 ms

**AT#SCFG?**

Read command returns the current socket configuration parameters values for all the six sockets, in the format:

```
#SCFG: <connId1>,<cid1>,<pktsz1>,<maxTo1>,<connTo1>,<txTo1><CR><LF>
#SCFG: <connId2>,<cid2>,<pktsz2>,<maxTo2>,<connTo2>,<txTo2><CR><LF>
...
#SCFG: <connId6>,<cid6>,<pktsz6>,<maxTo6>,<connTo6>,<txTo6>
```

**AT#SCFG=?**

Test command returns the range of supported values for all the parameters.



Example of test command.

- **AT#SCFG?**
#SCFG: 1,1,300,90,600,50
#SCFG: 2,2,300,90,600,50
#SCFG: 3,2,250,90,600,50
#SCFG: 4,1,300,90,600,50
#SCFG: 5,1,300,90,600,50
#SCFG: 6,1,300,90,600,50
OK

3.13.6. AT#SCFGEXT - Socket Configuration Extended

This command sets the socket configuration extended parameters.

SIM Presence	Setting saved	Can be aborted	MAX timeout	SELINT
Required	Auto	No	-	2



AT#SCFGEXT=<connId>,<srMode>,<recvDataMode>,<keepalive>[,<ListenAutoRsp>[,<sendDataMode>]]

Set command sets the socket configuration extended parameters.

Parameters:

Name	Type	Default	Description
<connId>	integer	1	socket connection identifier
Value:			
1÷conMax	:	socket connection identifier.	conMax value is returned by test command
<srMode>	integer	0	SRING unsolicited mode, see Additional info section.
Values:			
0	:	Normal	
1	:	Data amount	
2	:	Data view	
3	:	Data view with UDP datagram information	
<recvDataMode>	integer	0	Data view mode for received data in command mode (#SRECV or <srMode> = 2)
Values:			
0	:	Text mode	
1	:	Hexadecimal mode	
<keepalive>	integer	0	Set the TCP Keepalive value in minutes
Values:			
0	:	deactivated	
1÷240	:	keepalive time in minutes	
<ListenAutoRsp>	integer	0	set the listen auto-response mode, that affects the commands #SL and #SLUDP
Values:			
0	:	deactivated	
1	:	activated	
<sendDataMode>	integer	0	Data mode for sending data in command mode (#SEND)
Values:			

- 0 : data represented as text
- 1 : Data represented as sequence of hexadecimal numbers (from 00 to FF). Each octet of the data is given as two IRA character long.

Additional info:

▶▶ These are the **SRING** formats, depending on **<srMode>** setting:

if **<srMode>** = 0 (Normal):

SRING: **<connId>**

if **<srMode>** = 1 (Data amount):

SRING: **<connId>,<recData>**

if **<srMode>** = 2 (Data view):

SRING: **<connId>,<recData>,<data>**

if **<srMode>** = 3 (Data view with UDP datagram information):

SRING: **<sourceIP>,<sourcePort>,<connId>,<recData>,<dataLeft>,<data>**

Name	Type	Default	Description
<recData>	integer	-	amount of data received on the socket connection number <connId>
<data>	mixed	-	data received displayed following <recvDataMode> value
<sourceIP>	string	-	IP address of the source of data
<sourcePort>	string	-	IP port of the source of data
<dataLeft>	integer	-	number of bytes left in the UDP datagram

- Keepalive is available only on TCP connections.
- For the behavior of **#SL** and **#SLUDP** in case of auto response mode or in case of no auto response mode, see the description of the two commands.



AT#SCFGEXT?

Read command returns the current socket extended configuration parameters values for all the six sockets, in the format:

```
#SCFGEXT: <connId>,<srMode>,<dataMode>,<keepalive>,<ListenAutoRsp>,0<CR><LF>
...
#SCFGEXT:<connIdconMax>,<srMode>,<dataMode>,<keepalive>,<ListenAutoRsp>,0<CR><LF>
```



AT#SCFGEXT=?

Test command returns the range of supported values for all the sub parameters.



- Socket 1 set with data view string, text data mode, a keepalive time of 30 minutes and listen auto-response set.
Socket 3 set with data amount string, hex recv data mode, no keepalive and listen auto-response not set.
Socket 4 set with hex recv and send data mode.

```
AT#SCFGEXT?  
#SCFGEXT: 1,2,0,30,1,0  
#SCFGEXT: 2,0,0,0,0,0  
#SCFGEXT: 3,1,1,0,0,0  
#SCFGEXT: 4,0,1,0,0,1  
...  
...  
OK
```

3.13.7. AT#SCFGEXT2 - Socket Configuration Extended 2

Socket Configuration Extended.

SIM Presence	Setting saved	Can be aborted	MAX timeout	SELINT
Not required	Auto	No	-	2



AT#SCFGEXT2=<connId>,<bufferStart>[,<abortConnAttempt>[,<unused_B>[,<unused_C>[,<noCarrierMode>]]]]]

Set command sets the socket configuration extended parameters for features not included in #SCFGEXT command.

Parameters:

Name	Type	Default	Description
<connId>	integer	N/A	socket connection identifier
Value:			
1÷max	:	socket connection identifier value (max value is returned by the Test command)	
<bufferStart>	integer	0	select one of the two data sending timeout methods, the first one defined "old" the second one "new". The "old" data sending timeout method is set - by default - by #SCFG command, which sets also the <txTo> data sending timeout value. With #SCFGEXT2 command, you can set either the "old" or the "new" data sending timeout method. If the "new" method is selected, the "old" one is automatically disabled. The checking if new data have been received from serial port is done with a granularity that is directly related to #SCFG <txTo> setting with a maximum period of 1 sec.
Values:			
0	:	select "old" method: start transmission timer only first time if new data are received from the serial port	
1	:	select "new" method: restart transmission timer when new data is received from serial port	
<abortConnAttempt>	integer	0	enable the abort of an ongoing connection attempt started by #SD command and before the reception of the CONNECT message (in online mode) or OK message (in command mode). Values automatically saved in NVM.
Values:			
0	:	not possible to interrupt connection attempt	
1	:	it is possible to interrupt the connection attempt (<connTo> set by #SCFG or DNS resolution running if required) and give back control to AT interface by reception of a character. As soon as the control given to the AT interface, the ERROR message will be received on the interface itself.	
<unused_B>	integer	-	reserved for future use

<unused_C>	integer	-	reserved for future use
<noCarrierMode>	integer	0	select the NO CARRIER message format received when the socket is closed.





Values:

- 0 : no additional information is attached to NO CARRIER message
- 1 : NO CARRIER: <connId> message
- 2 : NO CARRIER: <connId>, <cause> message. Refer to Additional info section

Additional info:

- ▶▶ **<noCarrierMode>=2** selects the following **NO CARRIER** message format:
NO CARRIER: <connId>, <cause>

Name	Type	Default	Description
<cause>	integer	-	is the socket disconnection cause. Refer to #SLASTCLOSURE command to know its values and meanings.

-  Is necessary to avoid overlapping of the two methods. Enabling new method, the old method for transmission timer (**#SCFG**) is automatically disabled to avoid overlapping.
-  Check if new data have been received from serial port is done with a granularity directly related to **<txTo>** parameter which is set by **#SCFG** command. The maximum period is 1 sec.
-  Like **#SLASTCLOSURE**, in case of subsequent consecutive closure causes received, the original disconnection cause indicated.
-  In the case of command mode connection and remote closure with subsequent inactivity timeout closure without retrieval of all available data (**#SRECV** or **SRING** mode 2), it is indicated cause 1 for both possible FIN and RST from remote.



AT#SCFGEXT2?

Read command returns the current socket extended configuration of the six sockets. The format is:

```
#SCFGEXT2:<connId1>,<bufferStart1>,<abortConnAttempt1>,0,0,<noCarrierMode1><CR><LF>
...
#SCFGEXT2:<connId6>,<bufferStart6>,<abortConnAttempt6>,0,0,<noCarrierMode6><CR><LF>
```



AT#SCFGEXT2=?

Test command returns the range of supported values for all parameters.



- Set the new transmission timer behavior for `<connId>=1` and `<connId>=2` sockets.

```
AT#SCFGEXT2=1,1
OK
```

```
AT#SCFGEXT2=2,1
OK
```

Check the current extended configuration of the six sockets

```
AT#SCFGEXT2?
#SCFGEXT2: 1,1,0,0,0,0
#SCFGEXT2: 2,1,0,0,0,0
#SCFGEXT2: 3,0,0,0,0,0
#SCFGEXT2: 4,0,0,0,0,0
#SCFGEXT2: 5,0,0,0,0,0
#SCFGEXT2: 6,0,0,0,0,0
OK
```

Check the current configuration of the six sockets

```
AT#SCFG?
#SCFG: 1,1,300,90,600,50
#SCFG: 2,1,300,90,600,50
#SCFG: 3,1,300,90,600,50
#SCFG: 4,2,300,90,600,50
#SCFG: 5,2,300,90,600,50
#SCFG: 6,2,300,90,600,50
OK
```

Change the `<txTo>` data sending timeout of the `<connId>=1` socket.

```
AT#SCFG=1,1,300,90,600,30
OK
```

3.13.8. AT#SKTRST - Socket Parameters Reset

Socket Parameters Reset

SIM Presence	Setting saved	Can be aborted	MAX timeout	SELINT
Not required	Auto	No	-	2



AT#SKTRST

Execution command resets the **#SCFG** socket parameters to the "factory default" configuration and stores them in the NVM of the device.



AT#SKTRST=?

Test command returns the **OK** result code.



Reset of the socket parameters

```
AT#SKTRST
OK
```

3.13.9. AT#SD - Socket Dial

Execution command opens a remote connection via socket.

SIM Presence	Setting saved	Can be aborted	MAX timeout	SELINT
Required	No	No	-	2

AT#SD=<connId>,<txProt>,<rPort>,<IPAddr>,<closureType>[,<IPort>,<connMode>,<txTime>[,<userIpType>]]]]]

Execution command opens a remote connection via socket.

Parameters:

Name	Type	Default	Description
<connId>	integer	N/A	Socket connection identifier.
	Value:		
	1÷max	:	socket connection identifier value (max value is returned by the Test command)
<txProt>	integer	N/A	Transmission protocol.
	Values:		
	0	:	TCP
	1	:	UDP
<rPort>	integer	N/A	Remote host port to contact.
	Value:		
	1÷65535	:	remote host port number
<IPAddr>	string	-	IP address of the remote host: - any valid IP address in the format: "xxx.xxx.xxx.xxx" - any host name to be solved with a DNS query - any valid IPv6 address in the format: xxxx:xxxx:xxxx:xxxx:xxxx:xxxx:xxxx:xxxx or xxx.xxx.xxx.xxx.xxx.xxx.xxx.xxx. xxx.xxx.xxx.xxx.xxx.xxx.xxx.xxx
<closureType>	integer	0	Socket closure behavior only for TCP when remote host has closed. The parameter has no effects for UDP connections.
	Values:		
	0	:	local host closes immediately when remote host has closed
	255	:	local host closes after an escape sequence (+++)
<IPort>	integer	N/A	UDP connections local port <u>only</u> for UDP connections. The parameter has no effects for TCP connections.
	Value:		
	1÷65535	:	UDP local port number
<connMode>	integer	0	Connection mode.

Values:

- 0 : online mode connection
- 1 : command mode connection

<txTime>	integer	0	adjusting a time interval for series of UDP data packets will be uploaded.
-----------------------	---------	---	--

Values:

- 0 : Time interval is not requested
- 1÷1000 : Time interval in milliseconds

<userIpType>	integer	0	ip type for socket to open
---------------------------	---------	---	----------------------------

Values:

- 0 : no ip type chosen
 - 1 : ipv4
 - 2 : ipv6
-

- i** **<userIpType>** parameter is only valid when **<IPAddr>** is domain name and dual stack connection is open by **#SGACT**.
When **<userIpType>** is "no ip type chosen" ipv6 will be requested firstly. When ipv6 DNS server does not support so ipv4 will be requested.
- i** **<closureType>** parameter is valid for TCP connections only and has no effect (if used) for UDP connections.
- i** **<IPort>** parameter is valid for UDP connections only and has no effect (if used) for TCP connections
- i** If we set **<connMode>** to **online mode connection** and the command is successful we enter in **online data mode** and we see the intermediate result code **CONNECT**. After the **CONNECT** we can suspend the direct interface to the socket connection (N.B. the socket stays open) using the escape sequence (**+++**): the module moves back to **command mode** and we receive the final result code **OK** after the suspension.
After such a suspension, it is possible to resume it in every moment (unless the socket inactivity timer timeouts, see **#SCFG**) by using the **#SO** command with the corresponding **<connId>**.
- i** If we set **<connMode>** to **command mode connection** and the command is successful, the socket is opened, and we remain in **command mode** and we see the result code **OK**.
- i** If there are input data arrived through a connected socket and not yet read because the module entered **command mode** before reading them (after an escape sequence or after **#SD** has been issued with **<connMode>** set to **command mode connection**), these data are buffered and we receive the **SRING** URC (**SRING** presentation format depends on the last **#SCFGEXT** setting); it is possible to read these data afterwards issuing **#SRECV**. Under the same hypotheses it is possible to send data while in **command mode** issuing **#SEND**.
- i** **<txTime>** parameter is valid for UDP connections only and has no effect (if used) for TCP connections. For slow servers it is recommended to adjust the time interval for uploading series of data packets in order to do not lose data. The following data packet will be sent after the previous data packet's time interval has been expired.

AT#SD=?

Test command reports the range of values for all the parameters.



Examples of socket dial in online and command mode.

- Open socket 1 in online mode
AT#SD=1,0,80,"www.google.com",0,0,0

CONNECT

...

...

Open socket 1 in command mode

AT#SD=1,0,80,"www.google.com",0,0,1

OK

3.13.10. AT#SO - Socket Restore

Execution command resumes the direct interface to a socket connection which has been suspended by the escape sequence.

SIM Presence	Setting saved	Can be aborted	MAX timeout	SELINT
Required	Auto	No	-	2



AT#SO=<connId>

Parameter:

Name	Type	Default	Description
<connId>	integer	N/A	socket connection identifier

Value:

1÷conMax : socket connection identifier. conMax value is returned by test command



AT#SO=?

Test command reports the range of values for <connId> parameter

3.13.11. AT#SH - Socket Shutdown

The set command closes a socket.

SIM Presence	Setting saved	Can be aborted	MAX timeout	SELINT
Required	No	No	-	2



AT#SH=<connId>

Parameter:

Name	Type	Default	Description
<connId>	integer	N/A	socket connection identifier to be closed

Value:

1÷conMax : socket connection identifier. conMax value is returned by test command

 Socket cannot be closed in states "resolving DNS" and "connecting", see **#SS** command.



AT#SH=?

Test command reports the range for parameter <connId>

3.13.12. AT#SL - Socket Listen

The command opens/closes socket listening.

SIM Presence	Setting saved	Can be aborted	MAX timeout	SELINT
Required	No	No	-	2



AT#SL=<connId>,<listenState>,<listenPort>[,<lingerT>]

Set command opens/closes a socket listening for an incoming TCP connection on a specified port.

Parameters:

Name	Type	Default	Description
<connId>	integer	N/A	socket connection identifier
Value:			
1÷6	:	socket connection identifier	
<listenState>	integer	N/A	listening action
Values:			
0	:	close socket listening	
1	:	start socket listening	
<listenPort>	integer	N/A	local listening port
Value:			
1÷65535	:	local listening port value	
<lingerT>	integer	N/A	linger time
Values:			
0	:	immediate closure after remote closure	
255	:	local host closes only after an escape sequence (+++)	

- i If successful, command returns a final result code **OK**. If the ListenAutoRsp flag has not been set through the command **#SCFGEXT** (for the specific <connId>), then, when a TCP connection request comes on the input port, if the sender is not filtered by internal firewall (see **#FRWL**), an URC is received:

+SRING : <connId>

Afterwards we can use **#SA** to accept the connection or **#SH** to refuse it.

If the ListenAutoRsp flag has been set, then, when a TCP connection request comes on the input port, if the sender is not filtered by the internal firewall (see **#FRWL**), the connection is automatically accepted: the **CONNECT** indication is given and the modem goes into **online data mode**.

If the socket is closed by the network the following URC is received:

#SKTL: ABORTED

**AT#SL?**

Read command returns all the actual listening TCP sockets.

**AT#SL=?**

Test command returns the range of supported values of the parameters.



Open a socket listening for TCP on port 3500.

```
AT#SL=1,1,3500
```

```
OK
```

3.13.13. AT#SLUDP - Socket Listen UDP

This command opens/closes a socket listening for an incoming UDP connection on a specified port.

SIM Presence	Setting saved	Can be aborted	MAX timeout	SELINT
Required	Other	No	-	2



AT#SLUDP=<connId>,<listenState>,<listenPort>

Execution command opens/closes a socket listening for an incoming UDP connection on a specified port.

Parameters:

Name	Type	Default	Description
<connId>	integer	N/A	socket connection identifier
Value:			
1÷conMax	:	socket connection identifier.	conMax value is returned by test command
<listenState>	integer	0	indicates the action that will be performed
Values:			
0	:	closes socket listening	
1	:	starts socket listening	
<listenPort>	integer	1	local listening port
Value:			
1÷65535	:	available port numbers	

- i** If the ListenAutoRsp flag has not been set through the command **#SCFGEXT** (for the specific connId), then, when an UDP connection request comes on the input port, if the sender is not filtered by internal firewall (see **#FRWL**), an URC is received:

+SRING : <connId>

Afterwards we can use **#SA** to accept the connection or **#SH** to refuse it.

If the ListenAutoRsp flag has been set, then, when an UDP connection request comes on the input port, if the sender is not filtered by the internal firewall (see command **#FRWL**), the connection is automatically accepted: the **CONNECT** indication is given and the modem goes into online data mode.

If the socket is closed by the network the following URC is received:

#SLUDP: ABORTED

- i** when closing the listening socket <listenPort> is a don't care parameter

**AT#SLUDP?**

Read command returns all the actual listening UDP sockets.

**AT#SLUDP=?**

Test command returns the range of supported values for all the sub parameters.



Next command opens a socket listening for UDP on port 3500.

```
AT#SLUDP=1,1,3500
```

```
OK
```

3.13.14. AT#SA - Socket Accept

Execution command accepts an incoming socket connection.

SIM Presence	Setting saved	Can be aborted	MAX timeout	SELINT
Required	No	No	-	2



AT#SA=<connId>[,<connMode>]

Execution command accepts an incoming socket connection after an URC

SRING: <connId>

Parameters:

Name	Type	Default	Description
<connId>	integer	N/A	Socket connection identifier.

Value:



1÷max : Socket connection identifier value (max is returned by the Test command)

<connMode>	integer	0	Connection mode, as for command #SD.
------------	---------	---	--------------------------------------

Values:

0 : online mode connection

1 : command mode connection

-  The **SRING** URC has to be a consequence of a **#SL** issue.
-  Setting the command before to having received a **SRING** will result in an **ERROR** indication, giving the information that a connection request has not yet been received.



AT#SA=?

Test command reports the range of values for all the parameters.

3.13.15. AT#SSEND - Send Data in Command Mode

This command is used to send data through a connected socket.

SIM Presence	Setting saved	Can be aborted	MAX timeout	SELINT
Not required	No	No	-	2



AT#SSEND=<connId>[,<Rai>]

Execution command permits, while the module is in command mode, to send data through a connected socket.

After entering **AT#SSEND=...** command, and terminated the command line with **<CR>**, the module returns the following four characters sequence prompt, and waits for data to send:

<CR><LF><greater_than><space> (see IRA character set: 13, 10, 62, 32)

To send the entered data, enter Ctrl-Z char (0x1A hex); to abort the operation enter ESC char (0x1B hex).

If data are successfully sent, the command returns **OK**. If data sending fails for some reason, an error code is reported.

Parameters:

Name	Type	Default	Description
<connId>	integer	N/A	Selection on which Socket connection identifier send data.





Value:

1÷6 : Socket connection identifier supported

<Rai>	integer	1	RAI (Release Assistance Indication) configuration
--------------------	---------	---	---

Values:

- 1 : Set RAI to: "No further uplink or downlink data transmission subsequent to this transmission"
- 2 : Set RAI to: "Only a single downlink data transmission and no further uplink data transmissions subsequent to this transmission"

-  The maximum number of bytes to send is 1500 bytes; trying to send more data will cause the surplus to be discarded and lost.
-  It is possible to use **#SSEND** only if the connection was opened by **#SD**, else the ME is raising an error.
-  A byte corresponding to BS char (0x08) is treated with its corresponding meaning; therefore previous byte will be cancelled (and BS char itself will not be sent).
-  RAI (Release Assistance Indication) is supported in NB-IoT only, otherwise is ignored.

**AT#SSEND=?**

Test command returns the range of supported values for parameter <connId> and <Rai>.



Send data through socket number 2

```
AT#SSEND=2  
>Test<CTRL-Z>  
OK
```

3.13.16. AT#SSENDEXT - Send Data in Command Mode extended

This command allows to send data through a connected socket including all possible octets (from 0x00 to 0xFF).

SIM Presence	Setting saved	Can be aborted	MAX timeout	SELINT
Not required	No	No	-	2



AT#SSENDEXT=<connId>,<bytesToSend>[,<Rai>]

Execution command permits, while the module is in command mode, to send data through a connected socket including all possible octets (from 0x00 to 0xFF).

After entering **AT#SSENDEXT=...** command, and terminated the command line with **<CR>**, the module returns the following four characters sequence prompt, and waits for data to send:



<CR><LF><greater_than><space> (see IRA character set: 13, 10, 62, 32)

When **<bytesToSend>** bytes have been sent, operation is automatically completed.

If data are successfully sent, the command returns **OK**. If data sending fails for some reason, an error code is reported.

Parameters:

Name	Type	Default	Description
<connId>	integer	N/A	socket connection identifier
Value:			
1÷6 : socket connection identifier			
<bytesToSend>	integer	N/A	number of bytes to be sent
Value:			
1÷maxBytes : maxBytes is the maximum number of bytes that can be sent and it is reported by the test command			
<Rai>	integer	N/A	RAI (Release Assistance Indication) configuration
Values:			
1 : Set RAI to: "No further uplink or downlink data transmission subsequent to this transmission"			
2 : Set RAI to: "Only a single downlink data transmission and no further uplink data transmissions subsequent to this transmission"			

-  It's possible to use **#SSENDEXT** only if the connection was opened by **#SD**, else the modem returns an error.
-  All special characters are sent like a generic byte. For example, 0x08 is not interpreted as a BS (BackSpace) but it is simply sent through the socket.
-  RAI (Release Assistance Indication) is supported in NB-IoT only, otherwise is ignored.

**AT#SENDEXT=?**

Test command returns the range of supported values for parameters **<connId>**, **<bytesToSend>** and **<Rai>**.



Open the socket in command mode:

```
AT#SD=1,0,<port>,"IP address",0,0,1  
OK
```

Enter the command specifying total number of bytes as second parameter:

```
AT#SENDEXT=1,256
```

```
> ..... ;      Terminal echo of bytes sent is displayed here  
OK
```

All possible bytes (from 0x00 to 0xFF) are sent on the socket as generic bytes.

3.13.17. AT#SRECV - Socket Receive Data in Command Mode

The command permits the user to read data arrived through a connected socket when the module is in command mode.

SIM Presence	Setting saved	Can be aborted	MAX timeout	SELINT
Required	No	No	-	2



AT#SRECV=<connId>,<maxByte>[,<UDPIInfo>]

Execution command permits the user to read data arrived through a connected socket but buffered and not yet read because the module entered command mode before reading them; the module is notified of these data by a **SRING: URC**, whose presentation format depends on the last **#SCFGEXT** setting.

Parameters:

Name	Type	Default	Description
<connId>	integer	NA	socket connection identifier
Value:			
1÷conMax	:	socket connection identifier.	conMax value is returned by test command
<maxByte>	integer	NA	max number of bytes to read
Value:			
1÷1500	:	max number of bytes to read	
<UDPIInfo>	integer	0	enables/disables the visualization of UDP datagram information.
Values:			
0	:	UDP information disabled	
1	:	UDP information enabled, see Additional info section.	

Additional info:

- ▶▶ If <UDPIInfo> is set to 1 (**AT#SRECV=<connId>,<maxBytes>,1**), the command returns a message having the following format:

#SRECV: <remoteIP>,<remotePort><connId>,<recData>,<dataLeft>

Name	Type	Default	Description
<remoteIP>	string	-	remote ip address
<remotePort>	string	-	remote port address
<recData>	integer	-	received data
<dataLeft>	integer	-	remaining bytes in the datagram.



Issuing **#SRECV** when there is no buffered data raises an error.



AT#SRECV=?

Test command returns the range of supported values for parameters **<connId>** **<maxByte>** and **<UDPIInfo>**.

3.13.18. AT#SSENDUDP - Send UDP Data to a Specific Remote Host

This command allows to send data over UDP to a specific remote host.

SIM Presence	Setting saved	Can be aborted	MAX timeout	SELINT
Not required	No	No	-	2





AT#SSENDUDP=<connId>,<remoteIP>,<remotePort>[,<Rai>]

This command allows, while the module is in command mode, to send data over UDP to a specific remote host. UDP connection has to be previously completed with a first remote host through **#SLUDP** / **#SA**. Then, if module receives data from this or another host, it is able to send data to it. Like command **#SEND**, the device responds with ">" prompt and waits for the data to send.

Parameters:

Name	Type	Default	Description
<connId>	integer	1	socket connection identifier
Value:			
1÷6 : identifier number			
<remoteIP>	string	-	IP address of the remote host in dotted decimal notation, string type: "xxx.xxx.xxx.xxx"
<remotePort>	integer	1	remote host port
Value:			
1÷65535 : host port number			
<Rai>	integer	N/A	RAI (Release Assistance Indication) configuration
Values:			
1 : Set RAI to: "No further uplink or downlink data transmission subsequent to this transmission"			
2 : Set RAI to: "Only a single downlink data transmission and no further uplink data transmissions subsequent to this transmission"			

-  After **SRING** that indicates incoming UDP data and issuing **#SRECV** to receive data itself, through **#SS** is possible to check last remote host (IP/Port).
-  If successive resume of the socket to online mode is performed (**#SO**), connection with first remote host is restored as it was before.
-  RAI (Release Assistance Indication) is supported in NB-IoT only, otherwise is ignored.



AT#SSENDUDP=?

Test command reports the supported range of values for parameters <connId>,<remoteIP> and <remotePort> and <Rai>.



- Starts listening on <LocPort> (previous setting of firewall through #FRWL has to be done)

```
AT#SLUDP=1,1,<LocPort>
OK
```

```
SRING: 1          UDP data from a remote host available
```

```
AT#SA=1,1
OK
```

```
SRING: 1
```

```
AT#SI=1
#SI: 1,0,0,23,0    23 bytes to read
OK
```

```
AT#SRECV=1,23
#SRECV:1,23
message from first host
OK
```

```
AT#SS=1
#SS: 1,2,<LocIP>,<LocPort>,<RemIP1>,<RemPort1>
OK
```

```
AT#SENDUDP=1,<RemIP1>,<RemPort1>
>response to first host
OK
```

```
SRING: 1          UDP data from a remote host available
```

```
AT#SI=1
#SI: 1,22,23,24,0  24 bytes to read
OK
```

```
AT#SRECV=1,24
#SRECV:1,24
message from second host
OK
```

```
AT#SS=1
#SS: 1,2,<LocIP>,<LocPort>,<RemIP2>,<RemPort2>
OK
```

Remote host has changed, we want to send a response:

```
AT#SENDUDP=1,<RemIP2>,<RemPort2>
>response to second host
OK
```

3.13.19. AT#SENDUDPEXT - Send UDP Data to a Specific Remote Host EXTENDED

This command permits, while the module is in command mode, to send data over UDP to a specific remote host including all possible octets (from 0x00 to 0xFF)

SIM Presence	Setting saved	Can be aborted	MAX timeout	SELINT
Not required	Other	No	-	2



AT#SENDUDPEXT=<connId>,<bytestosend>,<remoteIP>,<remotePort>[,<Rai>]

Set command permits, while the module is in command mode, to send data over UDP to a specific remote host including all possible octets (from 0x00 to 0xFF).

As indicated about #SENDUDP, UDP socket has to be previously opened through #SLUDP / #SA, then we are able to send data to different remote hosts.

Like #SENDEXT, the device responds with the prompt '>' and waits for the data to send, operation is automatically completed when <bytestosend> have been sent.

Parameters:

Name	Type	Default	Description
<connId>	integer	N/A	socket connection identifier
Value:			
1÷6 : identifier number			
<bytestosend>	integer	N/A	bytes to be sent
Value:			
1÷1500 : number of bytes to be sent			
<remoteIP>	string	-	IP address of the remote host in dotted decimal notation ("xxx.xxx.xxx.xxx")
<remotePort>	integer	N/A	remote host port
Value:			
1÷65535 : host port number			
<Rai>	integer	N/A	RAI (Release Assistance Indication) configuration
Values:			
1 : Set RAI to: "No further uplink or downlink data transmission subsequent to this transmission"			
2 : Set RAI to: "Only a single downlink data transmission and no further uplink data transmissions subsequent to this transmission"			



RAI (Release Assistance Indication) is supported in NB-IoT only, otherwise is ignored.



AT#SENDUDPEXT=?

Test command reports the supported range of values for parameters <connId>, <bytestosend>, <remoteIP>, <remotePort> and <Rai>.

3.13.20. AT#SLASTCLOSURE - Detect the Cause of a Socket Disconnection

The command detects the cause of a socket disconnection.

SIM Presence	Setting saved	Can be aborted	MAX timeout	SELINT
Required	No	No	-	2



AT#SLASTCLOSURE=<connId>

Execution command reports the socket disconnection cause.

Parameter:

Name	Type	Default	Description
<connId>	integer	N/A	socket connection identifier

Value:

1÷conMax : socket connection identifier. conMax value is returned by test command

Additional info:

- ▶▶ The execution command reports the disconnection cause of the selected socket. The format of the returned message is:

#SLASTCLOSURE: <connId>,<cause>

Name	Type	Default	Description
<cause>	hex	0	socket disconnection cause.

Values:

- 0 : not available (socket has not yet been closed)
- 1 : remote host TCP connection close due to FIN/END: normal remote disconnection decided by the remote application
- 2 : remote host TCP connection close due to RST, all other cases in which the socket is aborted without indication from peer (for instance because peer doesn't send ack after maximum number of retransmissions/peer is no more alive). All these cases include all the "FATAL" errors after recv or send on the TCP socket (named as different from EWOULDBLOCK)
- 3 : socket inactivity timeout
- 4 : network deactivation (PDP context deactivation from network)

- i** Any time socket is re-opened, last disconnection cause is reset. Command report 0 (not available).
- i** User closure cause (**#SH**) is not considered and if a user closure is performed after remote disconnection, remote disconnection cause remains saved and is not overwritten.

-
- i** If more consecutive closure causes are received, the original disconnection cause is saved.
(For instance: if a TCP FIN is received from remote and later a TCP RST because we continue to send data, FIN cause is saved and not overwritten)
 - i** Also in case of **<closureType> (#SD)** set to 255, if the socket has not yet been closed by user after the escape sequence, **#SLASTCLOSURE** indicates remote disconnection cause if it has been received.
 - i** In case of UDP, cause 2 indicates abnormal (local) disconnection. Cause 3 and 4 are still possible.
(Cause 1 is obviously never possible)
 - i** In case of command mode connection and remote closure with subsequent inactivity timeout closure without retrieval of all available data (**#SRECV** or **SRING** mode 2), it is indicated cause 1 for both possible FIN and RST from remote.

**AT#SLASTCLOSURE=?**

Test command reports the supported range for parameter **<connId>**

3.13.21. AT#SS - Socket Status

Execution command reports the current sockets status.

SIM Presence	Setting saved	Can be aborted	MAX timeout	SELINT
Not required	No	No	-	2



AT#SS

Execution command reports the current sockets status using the following message format:

**#SS: <connId>,<state>,<locIP>,<locPort>,<remIP>,<remPort><CR><LF>
[<connId>,<state>,<locIP>,<locPort>,<remIP>,<remPort><CR><LF>[...]]**

Additional info:

▶▶ Parameters meaning.

Name	Type	Default	Description
<connId>	integer	-	socket connection identifier
<state>	integer	0	actual state of the socket
Values:			
	0	:	socket closed
	1	:	socket with an active data transfer connection
	2	:	socket suspended
	3	:	socket suspended with pending data
	4	:	socket listening
	5	:	socket with an incoming connection. Waiting for the user accept or shutdown command
	6	:	socket in opening process. The socket is not in Closed state but still not in Active or Suspended or Suspended with pending data state
<locIP>	string	-	IP address associated by the context activation to the socket
<locPort>	integer	-	two meanings: <ul style="list-style-type: none"> the listening port if we put the socket in listen mode the local port for the connection if we use the socket to connect to a remote machine
<remIP>	string	-	when we are connected to a remote machine this is the remote IP address
<remPort>	string	-	it is the port we are connected to on the remote machine



AT#SS=?

Test command reports the range for <connId> parameter.



- Get information about all sockets.
AT#SS
#SS: 1,3,91.80.90.162,61119,88.37.127.146,10510
#SS: 2,4,91.80.90.162,1000
#SS: 3,0
#SS: 4,0
#SS: 5,3,91.80.73.70,61120,88.37.127.146,10509
#SS: 6,0
OK

Socket 1: opened from local IP 91.80.90.162/local port 61119 to remote IP 88.37.127.146/remote port 10510 is suspended with pending data.

Socket 2: listening on local IP 91.80.90.162/local port 1000.

Socket 5: opened from local IP 91.80.73.70/local port 61120 to remote IP 88.37.127.146/remote port 10509 is suspended with pending data.

3.13.22. AT#SI - Socket Info

This command is used to get socket information.

SIM Presence	Setting saved	Can be aborted	MAX timeout	SELINT
Required	No	No	-	2



AT#SI[=<connId>]

Execution command returns information about all sockets data traffic.

Parameter:

Name	Type	Default	Description
<connId>	integer	NA	socket connection identifier. Refer to Additional info sections to have information about the use of the <connId> parameter

Value:

1÷conMax : socket connection identifier. conMax value is returned by test command

Additional info:

- ▶▶ If the execution command is used with the <connId> socket identifier, it returns data traffic information on the selected socket. The format of the returned message is:

#SI: <connId>,<sent>,<received>,<buff_in>,<ack_waiting>

Name	Type	Default	Description
<sent>	integer	-	total amount (in bytes) of data sent since the last time the socket connection identified by <connId> has been opened
<received>	integer	-	total amount (in bytes) of received data since the last time the socket connection identified by <connId> has been opened
<buff_in>	integer	-	total amount (in bytes) of data just arrived through the socket connection identified by <connId> and currently buffered, not yet read
<ack_waiting>	integer	-	total amount (in bytes) of sent and "not yet acknowledged data" since the last time the socket connection identified by <connId> has been opened. The data "not yet acknowledged" are available only for TCP connections. For UDP connections <ack_waiting> value is always 0.

- ▶▶ If the AT#SI command is used without the <connId> socket identifier, it returns data traffic information on all sockets. For each socket, the format of the returned message is:

#SI: <connId_n>,<sent_n>,<received_n>,<buff_in_n>,<ack_waiting_n>

**AT#SI=?**

Test command reports the range of **<connId>** parameter.



- Get information about data traffic of all sockets.

```
AT#SI  
#SI: 1,123,400,10,50  
#SI: 2,0,100,0,0  
#SI: 3,589,100,10,100  
#SI: 4,0,0,0,0  
#SI: 5,0,0,0,0
```

```
...  
OK
```

- Assume that sockets 1,2,3 are opened and having some data traffic. To get traffic information only for the socket **<connId>=1** enter the following command:

```
AT#SI=1  
#SI: 1,123,400,10,50  
OK
```

Socket **<connId>=1** has 123 bytes sent, 400 bytes received, 10 bytes waiting to be read and 50 bytes waiting to be acknowledged from the remote side.

3.13.23. AT#ST - Socket Type

Socket Type

SIM Presence	Setting saved	Can be aborted	MAX timeout	SELINT
Required	Auto	No	-	2



AT#ST[=<connId>]

Set command reports the current type of the socket (TCP/UDP) and its direction (Dialer/Listener)

Parameter:

Name	Type	Default	Description
<connId>	integer	N/A	socket connection identifier

Value:

1÷conMAX : socket connection identifier. conMax value is returned by test command

Additional info:

▶▶ The response format is:

#ST: <connId>,<type>,<direction>

Name	Type	Default	Description
<type>	integer	N/A	socket type

Values:

0 : No socket
1 : TCP socket
2 : UDP socket

Name	Type	Default	Description
<direction>	integer	N/A	direction of the socket

Values:

0 : None
1 : Dialer
2 : Listener

▶▶ Issuing **#ST** command without <connId> socket identifier, it returns information about type of all sockets. For each socket, the format of the returned message is:

#ST: <connId_n>,<type_n>,<direction_n><CR><LF>

**AT#ST=?**

Test command reports the range for parameter **<connId>**.



Examples for single socket and for all sockets

- For single socket

```
AT#ST=3  
#ST: 3,2,1
```

Socket 3 is an UDP dialer

- for all socket

```
AT#ST  
#ST: 1,0,0  
#ST: 2,0,0  
#ST: 3,2,1  
#ST: 4,2,2  
#ST: 5,1,1
```

...

Socket 1 is closed.

Socket 2 is closed.

Socket 3 is an UDP dialer

Socket 4 is an UDP listener

Socket 5 is a TCP dialer

3.13.24. AT#PADCMD - PAD Command Features

This command sets features of the pending data flush to socket, opened with #SD command.

SIM Presence	Setting saved	Can be aborted	MAX timeout	SELINT
Required	Auto	No	-	2



AT#PADCMD=<mode>

Set command for features of the pending data flush to socket, opened with #SD command.



Parameter:

Name	Type	Default	Description
<mode>	integer	N/A	enable/disable forwarding

Values:

0 : Bit 1: disable forwarding

1 : Bit 1: enable forwarding

-  Forwarding depends on character defined by #PADFWD.
-  Other bits are reserved.



AT#PADCMD?

Read command reports the currently selected <mode> in the format:

#PADCMD: mode



AT#PADCMD=?

Test command reports the supported range of values for parameter <mode>.

3.13.25. AT#PADFWD - PAD Forward Character

PAD forward character

SIM Presence	Setting saved	Can be aborted	MAX timeout	SELINT
Required	Auto	No	-	2



AT#PADFWD=<char>[,<mode>]

Set command sets the char that immediately flushes pending data to socket opened by AT#SD command

Parameters:

Name	Type	Default	Description
<char>	integer	1	specifies the ascii code of the char used to flush data
Value:			
0÷255	:	ascii code of the char used to flush data	
<mode>	integer	0	flush mode
Values:			
0	:	normal mode	
1	:	reserved	



Use AT#PADCMD to enable the socket char-flush activity



AT#PADFWD?

Read command reports the currently selected <char> and <mode> in the format:

#PADFWD: <char>,<mode>



AT#PADFWD=?

Test command reports the supported range of values for parameters <char> and <mode>

3.13.26. AT#BASE64 - Base64 Encoding/Decoding of Socket Sent/Received Data

This command is used to enable or disable base64 encoding and decoding data of a socket.



RFC 2045 - MIME
RFC 3548

SIM Presence	Setting saved	Can be aborted	MAX timeout	SELINT
Not required	Auto	No	-	2



AT#BASE64=<connId>,<enc>,<dec>[,<unused_B>[,<unused_C>]]

Set command enables base64 encoding and decoding of data sent/received to/from the socket in online or in command mode.

Parameters:

Name	Type	Default	Description
<connId>	integer	N/A	socket connection identifier
Value:			
1=	max	:	socket connection identifier value (max value is returned by the Test command)
<enc>	integer	0	selects the encoding standard. The data received from serial port are base64 encoded according to the <enc> parameter and forwarded to the <connId> socket.
Values:			
0	:		no encoding of data received from serial port.
1	:		base64 encoding compliant to RFC 2045 - MIME standard. As indicated from RFC2045 the encoded output stream is represented in lines of no more than 76 characters each. Lines are defined as sequences of octets separated by a CRLF sequence.
2	:		base64 encoding compliant to RFC 3548 standard. As indicated from RFC3548 CRLF have not to be added.
<dec>	integer	0	selects the decoding standard. The data received from the <connId> socket, are decoded according to the <dec> parameter and forwarded to the serial port.
Values:			
0	:		no decoding of data received from socket <connId>
1	:		base64 decoding compliant to RFC 2045 - MIME standard. Decoding of data received from socket <connId> and sent to serial port. Same rule as for <enc> regarding line feeds in the received file that has to be decoded.
2	:		base64 decoding compliant to RFC 3548 standard. Decoding of data received from socket <connId> and sent to serial port. Same rule as for <enc> regarding line feeds in the received file that has to be decoded.
<unused_B>	integer	-	reserved for future use

<unused_C> integer - reserved for future use

- i** It is possible to use command to change current **<enc>/<dec>** settings for a socket already opened in command mode or in online mode after suspending it. In this last case it is necessary to set **AT#SKIPESC=1**.
- i** To use #BASE64 in command mode, if data to send exceed maximum value for #SENDEXT command, they must be divided in multiple parts. These parts must be a multiple of 57 bytes, except for the last one, to distinguish EOF condition (Base64 encoding rules). For the same reason if #SRECV command is used by the application to receive data, a multiple of 78 bytes must be considered.
- i** To use #SRECV to receive data with **<dec>** enabled, it is necessary to consider that: reading **<maxByte>** bytes from socket, user will get less due to decoding that is performed.

**AT#BASE64?**

Read command returns the current **<enc>/<dec>** settings for all the six sockets. The format is:

#BASE64:<connId₁₁₁

...

#BASE64:<connId₆₆₆

**AT#BASE64=?**

Test command returns the range of supported values of all parameters.



- Skip the escape sequence, its transmission is not enabled

AT#SKIPESC=1
OK

Open a remote connection in online mode

AT#SD=<connId>,<txProt>,<rPort>,<IPAddr>
CONNECT

data sent without modifications (default)

.....

+++ (suspension)

OK

Encode data coming from serial port.

AT#BASE64=<connId>,1,0

OK

Resume suspended socket

AT#SO=<connId>

CONNECT

data received from serial port are base64 encoded and sent to the socket

.....

+++ (suspension)

OK

Decode data coming from socket.

AT#BASE64=<connId>,0,1

OK

Resume suspended socket

AT#SO=<connId>

CONNECT

data received from socket are base64 decoded and sent to the serial port

.....

+++ (suspension)

OK

3.13.27. AT#FRWL - Firewall Setup

This command controls the internal firewall settings.

SIM Presence	Setting saved	Can be aborted	MAX timeout	SELINT
Not required	No	No	-	2



AT#FRWL=[<action>[,<ip_addr>[,<net_mask>]]]

Set command controls the internal firewall settings

Parameters:

Name	Type	Default	Description
<action>	integer	0	command action
Values:			
	0	:	remove selected chain
	1	:	add an ACCEPT chain
	2	:	remove all chains (DROP everything); <ip_addr> and <net_mask> have no meaning in this case.
<ip_addr>	string	-	remote address to be added into the ACCEPT chain; it can be any valid IP address in the format: xxx.xxx.xxx.xxx
<net_mask>	string	-	mask to be applied on the <ip_addr>; it can be any valid IP address mask in the format: xxx.xxx.xxx.xxx

Additional info:

►► Firewall criterion

The firewall applies for incoming (listening) connections only. Its general policy is DROP, therefore all packets that are not included into an ACCEPT chain rule will be silently discarded.

When a packet comes from the IP address incoming_IP, the firewall chain rules will be scanned for matching with the following criteria:

incoming_IP & <net_mask> = <ip_addr> & <net_mask>

If criterion is matched, then the packet is accepted and the rule scan is finished; if criteria are not matched for any chain the packet is silently dropped



AT#FRWL?

Read command reports the list of all ACCEPT chain rules registered in the Firewall settings in the format:

```
#FRWL: <ip_addr>,<net_mask>
#FRWL: <ip_addr>,<net_mask>
...
OK
```

**AT#FRWL=?**

Test command returns the allowed values for parameter **<action>**.



- Let assume we want to accept connections only from our devices which are on the IP addresses ranging from

197.158.1.1 to 197.158.255.255

We need to add the following chain to the firewall:

```
AT#FRWL=1,"197.158.1.1","255.255.0.0"  
OK
```

3.13.28. AT#E2SLRI - Socket Listen Ring Indicator

This command enables the Ring Indicator pin response to a Socket Listen connect.

SIM Presence	Setting saved	Can be aborted	MAX timeout	SELINT
Required	Common profile	No	-	2



AT#E2SLRI=[<n>]

Set command enables/disables the Ring Indicator pin response to a Socket Listen connect and, if enabled, the duration of the negative going pulse generated on receipt of connect.

Parameter:

Name	Type	Default	Description
<n>	integer	0	RI enabling

Values:

- 0 : RI disabled for Socket Listen connect
- 50÷1150 : RI enabled for Socket Listen connect; a negative going pulse is generated on receipt of connect and <n> is the duration in ms of this pulse



AT#E2SLRI?

Read command reports whether the Ring Indicator pin response to a Socket Listen connect is currently enabled or not, in the format:

#E2SLRI: <n>



AT#E2SLRI=?

Test command returns the allowed values for parameter <n>.

3.13.29. AT#ICMP - Ping Support

Set command enables/disables the ICMP Ping support.

SIM Presence	Setting saved	Can be aborted	MAX timeout	SELINT
Required	Auto	No	-	2



AT#ICMP=<mode>

Parameter:

Name	Type	Default	Description
<mode>	integer	1	ICMP mode selection.

Values:

- 0 : disable ICMP Ping support
- 1 : enable firewalled ICMP Ping support: the module is sending a proper ECHO_REPLY only to a subset of IP Addresses pinging it; this subset of IP Addresses has been previously specified through #FRWL command.
- 2 : enable free ICMP Ping support; the module is sending ECHO_REPLY to every IP Address pinging it.



AT#ICMP?

Read command returns whether the ICMP Ping support is currently enabled or not, in the format:

#ICMP: <mode>



AT#ICMP=?

Test command reports the supported range of values for the <mode> parameter.

3.13.30. AT#PING - Send PING Request

This command is used to send Ping Echo Request.

SIM Presence	Setting saved	Can be aborted	MAX timeout	SELINT
Required	Other	No	-	2



AT#PING=<IPAddr>[,<retryNum>[,<len>[,<timeout>[,<tTl>[,<pdpld>]]]]]

Execution command is used to send Ping Echo Request messages and to receive the corresponding Echo Reply. Before sending PING Request the PDP context must be activated by **#SGACT** command.

Once the single Echo Reply message is received, a string like that is displayed:

#PING: <replyId>,<Ip Address>,<replyTime>,<tTl>

Parameters:

Name	Type	Default	Description
<IPAddr>	string	-	address of the remote host, string type. This parameter can be either: - any valid IP address in the format: "xxx.xxx.xxx.xxx" - any host name to be solved with a DNS query
<retryNum>	integer	4	the number of Ping Echo Request to send Value: 1÷64 : Ping Echo Request number
<len>	integer	32	the length of Ping Echo Request message Value: 32÷1460 : Ping Echo Request length
<timeout>	integer	50	the timeout, in 100 ms units, waiting a single Echo Reply Value: 1÷600 : timeout, in 100 ms units
<tTl>	integer	128	time to live Value: 1÷255 : time to live
<pdpld>	integer	-	specifies a PDP context definition. Use the AT+CGDCONT=? test command to get the range of the supported values. Refer to additional info section for default value.

Additional info:



►► **<pdpld>** default value.

The default value of this parameter depends on the software customization as shown in the following table.

Software customization	<pdpld> default value
Verizon	3
All other	1

Unsolicited fields:

Name	Type	Description
<replyId>	integer	Echo Reply number
<IpAddress>	string	IP address of the remote host
<replyTime>	integer	time, in 100 ms units, required to receive the response
<tTl>	integer	time to live of the Echo Reply message

-  When the Echo Request timeout expires (no reply received on time) the response will contain <replyTime> set to 600 and <tTl> set to 255.
-  To receive the corresponding Echo Reply is not required to enable separately **#ICMP**



AT#PING=?

Test command reports the supported range of values for the **#PING** command parameters.



```
AT#PING="www.telit.com"
#PING: 01,"81.201.117.177",6,50
#PING: 02,"81.201.117.177",5,50
#PING: 03,"81.201.117.177",6,50
#PING: 04,"81.201.117.177",5,50
OK
```

3.13.31. AT#QDNS - Query DNS

The command executes a DNS query

SIM Presence	Setting saved	Can be aborted	MAX timeout	SELINT
Required	No	No	-	2



AT#QDNS[=<host name>]

Execution command executes a DNS query to solve the host name into an IP address. If the DNS query is successful, then the IP address will be reported in the result code as follows:

#QDNS: <host name>,<IP address>

Parameter:

Name	Type	Default	Description
<host name>	string	-	Host name string

Additional info:

- ▶▶ IP address in the result code

Name	Type	Default	Description
<IP address>	string	-	IP address in format "xxx.xxx.xxx.xxx"

- i** The command activates the PDP context if it was not previously activated. In this case the context is deactivated after the DNS query.
- i** This command requires that the authentication parameters are correctly set, and the PS network is present.



AT#QDNS=?

Test command returns the **OK** result code.

3.13.32. AT#CACHEDNS - DNS Response Caching

This command is related to DNS and DNS response caching.

SIM Presence	Setting saved	Can be aborted	MAX timeout	SELINT
Not required	No	No	-	2



AT#CACHEDNS=[<mode>]

Set command enables caching a mapping of domain names to IP addresses, as does a resolver library.

Parameter:

Name	Type	Default	Description
<mode>	integer	0	enables/disables caching

Values:

- 0 : caching disabled; it cleans the cache too
- 1 : caching enabled

- The validity period of each cached entry (i.e. how long a DNS response remains valid) is determined by a value called the Time To Live (TTL), set by the administrator of the DNS server handing out the response.
- If the cache is full (8 elements) and a new IP address is resolved, an element is deleted from the cache: the one that has not been used for the longest time.
- It is recommended to clean the cache, if command **+CCLK** has been issued while the DNS Response Caching was enabled.



AT#CACHEDNS?

Read command reports whether the DNS Response Caching is currently enabled or not, in the format:

#CACHEDNS: <mode>



AT#CACHEDNS=?

Test command returns the currently cached mapping along with the range of available values for parameter <mode>, in the format:

#CACHEDNS: [<hostn₁>,<IPAddr₁>,[...,[<hostn_n>,<IPAddr_n>]](0,1)

Additional info:

- ▶▶ Response parameters

Name	Type	Default	Description
------	------	---------	-------------

<hostn>	string	-	host name
<IPaddr>	string	-	IP address in the format " xxx.xxx.xxx.xxx "

3.13.33. AT#DNS - Manual DNS Selection

This command manually set primary and secondary DNS servers.

SIM Presence	Setting saved	Can be aborted	MAX timeout	SELINT
Not required	Auto	No	-	2



AT#DNS=<cid>,<primary>,<secondary>

Set command allows to manually set primary and secondary DNS servers either for a PDP context defined by +CGDCONT.

Parameters:

Name	Type	Default	Description
<cid>	integer	-	specifies a particular PDP context definition, see +CGDCONT command.
<primary>	string	-	<p>Ipv4 manual primary DNS server, format: "xxx.xxx.xxx.xxx" used for the specified cid; it can be used instead of the primary DNS server come from the network (default is "0.0.0.0")</p> <p>Ipv6 manual primary DNS server, format: "xxx.xxx.xxx.xxx.xxx.xxx.xxx.xxx.xxx.xxx.xxx.xxx" used for the specified cid; it can be used instead of the primary DNS server come from the network (default is "0.0.0.0.0.0.0.0.0.0.0.0.0.0.0.0").</p> <p>Ipv6 can also be in HEX format: "xxxx:xxxx:xxxx:xxxx:xxxx:xxxx:xxxx:xxxx"</p>
<secondary>	string	-	<p>Ipv4 manual secondary DNS server, format: "xxx.xxx.xxx.xxx" used for the specified cid; it can be used instead of the secondary DNS server come from the network (default is "0.0.0.0")</p> <p>Ipv6 manual secondary DNS server, format: "xxx.xxx.xxx.xxx.xxx.xxx.xxx.xxx.xxx.xxx.xxx.xxx" used for the specified cid; it can be used instead of the secondary DNS server come from the network (default is "0.0.0.0.0.0.0.0.0.0.0.0.0.0.0.0").</p> <p>Ipv6 can also be in HEX format: "xxxx:xxxx:xxxx:xxxx:xxxx:xxxx:xxxx:xxxx"</p>

- i** If <primary> is "0.0.0.0" and <secondary> is not "0.0.0.0", then issuing AT#DNS=... raises an error.
- i** If <primary> is "0.0.0.0" we are using the primary DNS server come from the network as consequence of a context activation.
- i** If <primary> is not "0.0.0.0" and <secondary> is "0.0.0.0", then we are using only the manual primary DNS server.
- i** The context identified by <cid> has to be previously defined, otherwise issuing AT#DNS=... raises an error.
- i** The context identified by <cid> has to be not activated yet, otherwise issuing AT#DNS=...raises an error.

**AT#DNS?**

Read command returns the manual DNS servers set for every defined PDP context, in the format:

```
[#DNS: <cid>,<primary>,<secondary>[<CR><LF>
```

```
#DNS: <cid>,<primary>,<secondary>]]
```

In case **+CGDCONT** determined as ipv4v6, the format is:

```
[#DNS: <cid>,<primary ip4>,<primary ip6>,<secondary ip4>,<secondary ip6>[<CR><LF>
```

```
#DNS: <cid>,<primary ip4>,<primary ip6>,<secondary ip4>,<secondary ip6>]]
```

**AT#DNS=?**

Test command reports the supported range of values for the **<cid>** parameter only.

3.13.34. AT#NWDNS - DNS from Network

The command allows to get the primary and secondary DNS addresses for selected GSM or PDP context identifiers

SIM Presence	Setting saved	Can be aborted	MAX timeout	SELINT
Not required	Auto	No	-	2



AT#NWDNS=[<cid>[,...]]

Execution command returns either the primary and secondary DNS addresses for the GSM context (if specified) and/or a list of primary and secondary DNS addresses for the specified PDP context identifiers. The command returns a row of information for every specified <cid> whose context has been already defined. No row is returned for a <cid> whose context has not been defined yet. The response is in the form:

```
#NWDNS: <cidn>,<PDNSaddressn>,<SDNSaddressn><CR><LF>
#NWDNS: <cidp>,<PDNSaddressp>,<SDNSaddressp><CR><LF>
...
#NWDNS: <cidq>,<PDNSaddressq>,<SDNSaddressq><CR><LF>
```

Parameter:

Name	Type	Default	Description
<cid>	integer	N/A	Generic context identifier. The value of max is returned by the test command

Value:

1÷max : specifies a particular PDP context definition (see +CGDCONT command)

Additional info:

▶▶ Parameters response description:

Name	Type	Default	Description
<PDNSaddress>	string	-	Generic primary DNS address, the same set through #DNS or otherwise assigned during PDP (or GSM) context activation.
<SDNSaddress>	string	-	Generic secondary DNS address, the same set through #DNS, or otherwise assigned during PDP (or GSM) context activation.

i Entering AT#NWDNS= (no <cid> specified), the DNS addresses for all defined contexts are returned.

i Issuing the command with more than 6 input parameters raises an error.

-
-  The command returns only one row of information for every specified **<cid>**, even if the same **<cid>** is present more than once.



AT#NWDNS=?

Test command returns a list of defined **<cid>**s.

3.13.35. AT#NTP - Calculate and Update Date and Time with NTP

The command handles the date and time update using NTP protocol.



[1] Standard RFC2030

SIM Presence	Setting saved	Can be aborted	MAX timeout	SELINT
Required	No	No	10 s	2



AT#NTP=<NTPAddr>,<NTPPort>,<updModClock>,<timeout>[,<timeZone>]

Execution command permits to calculate and update date and time through NTP protocol sending a request to a NTP server, see standard [1]. The command returns an intermediate response having the following format:

#NTP: <time>

The <time> parameter is described in Additional info section.

Parameters:

Name	Type	Default	Description
<NTPAddr>	string	-	address of the NTP server. This parameter can be either: <ul style="list-style-type: none"> any valid IP address in the format: "xxx.xxx.xxx.xxx" or "xxxx:xxxx:xxxx:xxxx:xxxx:xxxx:xxxx:xxxx" any host name to be solved with a DNS query
<NTPPort>	integer	N/A	NTP server port to contact Value: 1÷65535 : port
<updModClock>	integer	N/A	update mode Values: 0 : no update module clock 1 : update module clock
<timeout>	integer	N/A	waiting timeout for server response in seconds Value: 1÷10 : waiting timeout for server response in seconds
<timeZone>	string	0	Time Zone: indicates the difference, expressed in quarter of an hour, between the local time and GMT. Value: -47÷48 : Time Zone

Additional info:

►► Intermediate response parameter.

Name	Type	Default	Description
<time>	string	-	current time as quoted string in the format: "yy/MM/dd,hh:mm:ss+zz"

i The Time Zone is applied directly in the Date and Time received by the NTP Server, that is, by definition, GMT+0.

i **#SGACT** must be called to activate the PDP context before calling **#NTP** command.



AT#NTP=?

Test command returns the maximum length for <NTPAddr> string, and supported range of values of parameters: <NTPPort>, <updModClock>, <timeout> and <timeZone>.



Execution command with NTP server.

```
AT#NTP="0.it.pool.ntp.org",123,1,2,4
#NTP: 19/03/13, 13:16:33+04
OK
```

```
AT+CCLK?
+CCLK: "19/03/13, 13:16:34+04"
OK
```

3.13.36. AT#NTPCFG - Configure NTP Parameters

This set command allows to configure additional parameters to be used for NTP operations.

SIM Presence	Setting saved	Can be aborted	MAX timeout	SELINT
Required	No	No	-	2



AT#NTPCFG=<cid>[,<authType>]

Parameters:

Name	Type	Default	Description
<cid>	integer	-	context id used to perform NTP operations. Refer to test command to know the supported range of values.
<authType>	integer	-	authentication type to be used with NTP server. The only value accepted is 0, no authentication.



AT#NTPCFG=?

Test command reports the available range of parameters values.



```
AT#NTPCFG=3
OK
```

3.13.37. AT#GDATAVOL - PS Data Volume

The command resets data counters or reports data counts of the PS sessions.

SIM Presence	Setting saved	Can be aborted	MAX timeout	SELINT
Required	Auto	No	-	2



AT#GDATAVOL=[<mode>]

Execution command reports, for every active PDP context, the amount of data the last PS session received and transmitted, or it will report the total amount of data received and transmitted during all past PS sessions, since last reset.

Parameter:

Name	Type	Default	Description
<mode>	integer	0	resets or reads data counters.

Values:

- 0 : resets the PS data counter for the all the available PDP contexts (1-16)
- 1 : reports the last PS session data counter for the all the set PDP contexts (i.e. all the PDP contexts with APN parameter set using +CGDCONT). Refer to Additional info section to see the format.
- 2 : reports the total PS data counter, since last reset, for the all the set PDP contexts (i.e. all the PDP context with APN parameter set using +CGDCONT). Refer to Additional info section to see the format.

Additional info:

- ▶▶ When <mode>=1, the command returns the following last data counts:

The message format is:

```
#GDATAVOL: <cidn>,<totn>,<sentn>,<receivedn>[<CR><LF>
```

...

```
#GDATAVOL: <cidm>,<totm>,<sentm>,<receivedm>[...]]
```

Each message line shows the data related to the n-th, m-th, and so on <cid>.

Name	Type	Default	Description
<cid>	integer	N/A	contexts identifiers
Value:			
0÷16	:		context identifiers
<totn>	integer	-	number of bytes either received or transmitted in the last PS session for <cid _n > PDP context;
<sentn>	integer	-	number of bytes transmitted in the last PS session for <cid _n > PDP context;
<receivedn>	integer	-	number of bytes received in the last PS session for <cid _n > PDP context;

- When **<mode>=2**, the command returns the following total data counts, since last reset executed by **AT#GDATAVOL=0**

The message format is:



#GDATAVOL: <cid_n>,<tot_n>,<sent_n>,<received_n>[<CR><LF>

...

#GDATAVOL: <cid_m>,<tot_m>,<sent_m>,<received_m>[...]]

Each message line shows the data related to the n-th, m-th, and so on <cid>.

Name	Type	Default	Description
<totn>	integer	-	number of bytes either received or transmitted in every PS session since last reset, for <cid_n> PDP context.
<sentn>	integer	-	number of bytes transmitted, in every PS session since last reset, for <cid_n> PDP context
<receivedn>	integer	-	number of bytes received, in every PS session since last reset, for <cid_n> PDP context

-  Last PS session counters not saved in NVM so they are loosen at power off.
-  Total PS session counters saved on NVM.



AT#GDATAVOL=?

Test command returns the supported range of the **<mode>** parameter values.

3.13.38. AT#SCFGEXT3 - Socket Configuration Extended 3

This command sets the socket configuration extended parameters for features not included in #SCFGEXT command nor in #SCFGEXT2 command.

SIM Presence	Setting saved	Can be aborted	MAX timeout	SELINT
Required	Auto	No	-	2

```

 AT#SCFGEXT3=<connId>,<immRsp>[,<closureTypeCmdModeEnabling>[,<fastSRING>[,<ssendTimeout>[,<unusedD>]]]]
    
```

Parameters:

Name	Type	Default	Description
<connId>	integer	N/A	socket connection identifier
Value:			
1÷max : socket connection identifier value (max value is returned by the test command)			
<immRsp>	integer	0	enables #SD command mode immediate response
Values:			
0 : #SD in command mode (see #SD) returns after the socket is connected			
1 : #SD in command mode returns immediately; then the state of the connection can be read by the AT command #SS			
<closureTypeCmdModeEnabling>	integer	0	it has no effect and is included only for backward compatibility
Value:			
0 : factory default			
<fastSRING>	integer	0	it has no effect and is included only for backward compatibility
Value:			
0 : factory default			
<ssendTimeout>	integer	0	timeout for #SEND
Values:			
0 : no timeout			
100÷600 : timeout in 100 msec units			
<unusedD>	mixed	0	unused parameter
Value:			
0 : factory default			

 **AT#SCFGEXT3?**

Read command returns the current socket extended configuration parameters values for all the max sockets, in the format:

```
#SCFGEXT3:<connIdi>,<immRspi>,<closureTypeCmdModeEnabling>,  
<fastsring>,<ssendTimeout>,0<CR><LF>
```

...

```
#SCFGEXT3:<connIdmax>,<immRspmax>,<closureTypeCmdModeEnabling>,  
<fastsring>,<ssendTimeout>,0<CR><LF>
```

 **AT#SCFGEXT3=?**

Test command returns the range of supported values for all the parameters.

3.14. FTPEasy

3.14.1. AT#FTPAPP - FTP Append

This command is used to append data to an already existing file via FTP during an FTP session.

SIM Presence	Setting saved	Can be aborted	MAX timeout	SELINT
Not required	No	No	-	2



AT#FTPAPP=<fileName>[,<connMode>]

Set command, issued during an FTP connection, opens a data connection and append data to existing <fileName> file.



If the data connection succeeds, a **CONNECT** indication is sent, afterward a **NO CARRIER** indication is sent when the socket is closed.

Parameters:

Name	Type	Default	Description
<fileName>	string	-	the file name
<connMode>	integer	0	the connection mode

Values:

- 0 : online mode
- 1 : command mode

-  If <connMode> is set to 1, the data connection is opened, the device remains in command mode and the **OK** result code is displayed (instead of **CONNECT**).
-  Use the escape sequence **+++** to close the data connection.
-  The command causes an **ERROR** result code if no FTP connection has been opened yet.



AT#FTPAPP=?

Test command reports the maximum length of <fileName> and the supported range of values of <connMode>. The format is:

#FTPAPP: <length>, (list of supported <connMode>s)

Additional info:

- ▶▶ Parameter meaning.

Name	Type	Default	Description
<length>	integer	-	is the maximum length of <fileName>

3.14.2. AT#FTPAPPEXT - FTP Append Extended

The command sends data on a FTP data port while the module is in command mode.

SIM Presence	Setting saved	Can be aborted	MAX timeout	SELINT
Required	No	No	-	2



AT#FTPAPPEXT=<bytesToSend>[,<eof>]

Execution command sends data on a FTP data port while the module is in command mode.

FTP data port must be previously opened by #FTPPUT (or #FTPAPP) with <connMode> parameter set to command mode connection.

After command line is terminated with <CR>, the module responds sending a four characters sequence prompt, and waits for the specified number of bytes:

<CR><LF><greater_than><space> (IRA 13, 10, 62, 32)

When <bytesToSend> bytes have been sent, operation is automatically completed. If (all or part of the) data are successfully sent, then the response is:

#FTPAPPEXT: <sentBytes>
OK

If data sending fails for some reason, an error code is reported.

Parameters:

Name	Type	Default	Description
<bytesToSend>	integer	N/A	number of bytes to be sent
Value:			
1÷1500 : number of bytes			
<eof>	integer	0	data port closure
Values:			
0 : normal sending of data chunk			
1 : close data port after sending data chunk			

Additional info:

▶▶ Parameters:

Name	Type	Default	Description
<sentBytes>	integer	N/A	the number of sent bytes
Value:			
1÷1500 : number of bytes			

i <sentBytes> could be less than <bytesToSend>.

**AT#FTPAPPEXT=?**

Test command reports the supported values of parameters **<bytesToSend>** and **<eof>**.



```
AT#FTPOPEN="IP",username,password
OK
```

```
AT#FTPPUT=<filename>,1
OK
```

the second param (1) means that we open the connection in command mode
Here data socket will stay opened, but interface will be available (command mode)

```
AT#FTPAPPEXT=Size
>binary data
#FTPAPPEXT: <sentBytes>
OK
```

write here the binary data. As soon Size bytes are written, data are sent and **OK** is returned
Last **#FTPAPPEXT** will close the data socket, because second (optional) parameter has this meaning:

```
AT#FTPAPPEXT=Size,1
>binary data
#FTPAPPEXT: <sentBytes>
OK
```

write here the binary data. As soon Size bytes are written, data are sent and **OK** is returned
and the data socket is closed.

If the user has to reopen the data port to send another (or append to the same) file, they can restart with **#FTPPUT** (or **#FTPAPP**).

Then **#FTPAPPEXT** to send the data chunks on the reopened data port.

If, while sending the chunks, the data port is closed from remote, user will be aware of it because **#FTPAPPEXT** will indicate **ERROR** and cause (available if previously issued the command **AT+CMEE=2**) will indicate that socket has been closed.

Also in this case obviously, data port will have to be reopened with **#FTPPUT** and the related commands.

3.14.3. AT#FTPCLOSE - FTP Close Command

The command purpose is to close the previously open FTP connection.

SIM Presence	Setting saved	Can be aborted	MAX timeout	SELINT
Required	No	No	-	2



AT#FTPCLOSE

Execution command closes an FTP connection.



AT#FTPCLOSE=?

Test command returns the **OK** result code.

3.14.4. AT#FTPCWD - FTP Change Working Directory

Command to change the working directory on FTP server.

SIM Presence	Setting saved	Can be aborted	MAX timeout	SELINT
Required	No	No	-	2



AT#FTPCWD=[<dirname>]

Execution command, issued during an FTP connection, changes the working directory on FTP server.

Parameter:

Name	Type	Default	Description
<dirname>	string	-	Name of the new working directory.

-  The command causes an **ERROR** result code to be returned if no FTP connection has been opened yet.



AT#FTPCWD=?

Test command returns the **OK** result code.

3.14.5. AT#FTPDELE - FTP Delete

This command, issued during a FTP connection, allows to delete a file from the remote working directory.

SIM Presence	Setting saved	Can be aborted	MAX timeout	SELINT
Required	No	No	-	2





AT#FTPDELE=[<filename>]

Execution command, issued during a FTP connection, deletes a file from the remote working directory.

Parameter:

Name	Type	Default	Description
<filename>	string	-	Name of the file that must be deleted

-  This command returns an **ERROR** result code if no FTP connection has been opened yet.
-  This command returns an **ERROR** result code in case of delayed server response. If this is the case, the **#FTPMSG** response is temporarily empty; a later check of the **#FTPMSG** response will show the server response.



AT#FTPDELE=?

Test command returns **OK** result code.

3.14.6. AT#FTPFSIZE - Get File Size from FTP Server

This command returns the size of a file located on a FTP server.

SIM Presence	Setting saved	Can be aborted	MAX timeout	SELINT
Required	No	No	-	2



AT#FTPFSIZE=<filename>

Execution command, issued during an FTP connection, permits to get the size of a file located on a FTP server. The response format is:

#FTPFSIZE: <size>

Parameter:

Name	Type	Default	Description
<filename>	string	-	the name of the file that you want to know the size

Additional info:

▶▶ Parameter:

Name	Type	Default	Description
<size>	integer	-	dimension in bytes of the file located on the FTP server



AT#FTPTYPE=0 command must be issued before **#FTPFSIZE** command, to set file transfer type to binary mode.



AT#FTPFSIZE=?

Test command returns **OK** result code.

3.14.7. AT#FTPGET - FTP Get Command

This command executes the FTP Get function during an FTP connection.

SIM Presence	Setting saved	Can be aborted	MAX timeout	SELINT
Not required	No	No	-	2





AT#FTPGET=[<filename>]

Execution command opens a data connection and starts getting a file from the FTP server. If the data connection succeeds a **CONNECT** indication is sent and the file is received on the serial port.

Parameter:

Name	Type	Default	Description
<filename>	string	-	file name to get from server.

-  The command causes an **ERROR** result code to be returned in case no FTP connection has been opened yet.
-  Command closure should always be handled by application. To avoid download stall situations a timeout should be implemented by the application.



AT#FTPGET=?

Test command returns the **OK** result code.

3.14.8. AT#FTPGETPKT - FTP Get in Command Mode

FTP gets in command mode.

SIM Presence	Setting saved	Can be aborted	MAX timeout	SELINT
Required	No	No	-	2



AT#FTPGETPKT=<fileName>[,<viewMode>]

Execution command, issued during an FTP connection, opens a data connection and starts getting a file from the FTP server while remaining in command mode.

The data port is opened, we remain in command mode and we see the result code **OK**.

Retrieval from FTP server of <fileName> is started, but data are only buffered in the module.



It is possible to read data afterwards issuing #FTPGETPKT command.

Parameters:

Name	Type	Default	Description
<fileName>	string	-	file name. Maximum length: 200 characters.
<viewMode>	integer	0	choose the view mode

Values:

- 0 : text format
- 1 : hexadecimal format

-  The command causes an **ERROR** result code to be returned in case no FTP connection has been opened yet.
-  Command closure should always be handled by application. To avoid download stall situations a timeout should be implemented by the application.



AT#FTPGETPKT?

Read command reports current download state for <fileName> with <viewMode> chosen, in the format:

#FTPGETPKT: <remotefile>,<viewMode>,<eof>

Additional info:

- ▶▶ The following parameter signals the state of the file transmission.

Name	Type	Default	Description
<eof>	integer	N/A	End of file

Values:

- 0 : file currently being transferred
- 1 : complete file has been transferred to FTP client



AT#FTPGETPKT=?

Test command returns **OK** result code.

3.14.9. AT#FTPLIST - FTP List

This command is used during a FTP connection.

SIM Presence	Setting saved	Can be aborted	MAX timeout	SELINT
Not required	No	No	-	2





AT#FTPLIST=[<name>]

Execution command, issued during an FTP connection, opens a data connection and starts getting from the server the list of contents of the specified directory or the properties of the specified file

Parameter:

Name	Type	Default	Description
<name>	string	-	is the name of the directory or file

-  The command causes an **ERROR** result code to be returned if no FTP connection has been opened yet.
-  Issuing **AT#FTPLIST<CR>** opens a data connection and starts getting from the server the list of contents of the working directory.



AT#FTPLIST=?

Test command returns the **OK** result code.

3.14.10. AT#FTPMSG - FTP Read Message

This command returns the last response received from the FTP server.

SIM Presence	Setting saved	Can be aborted	MAX timeout	SELINT
Required	No	No	-	2



AT#FTPMSG

Execution command returns the last response received from the server during an FTP connection.



AT#FTPMSG=?

Test command returns the **OK** result code.

3.14.11. AT#FTPOPEN - FTP Connection Opening

This execution command opens an FTP connection toward the FTP server.

SIM Presence	Setting saved	Can be aborted	MAX timeout	SELINT
Required	No	No	-	2



AT#FTPOPEN=[[<server:port>,<username>,<password>,<mode>],<cid>]

Parameters:

Name	Type	Default	Description
<server:port>	string	-	address and port of FTP server (factory default port 21), in the format: <ul style="list-style-type: none"> "ipv4" / "ipv4:port" "ipv6" / "[ipv6]" / "[ipv6]:port" "dynamic_name" / "dynamic_name:port"
<username>	string	-	authentication user identification for FTP
<password>	string	-	authentication password for FTP
<mode>	integer	0	active or passive mode

Values:

- 0 : active mode
- 1 : passive mode

<cid>	string	-	PDP context identifier
--------------------	--------	---	------------------------

- i** In FTP Open case, the solution dependency limits the maximum time out to 1200 (120 seconds). The FTPTO value that exceed 1200 is considered as 1200.
- i** Before opening FTP connection the PDP context must been activated with **#SGACT**.



AT#FTPOPEN=?

Test command returns the **OK** result code

3.14.12. AT#FTPPUT - FTP Send File

This command sends a file to the FTP server.

SIM Presence	Setting saved	Can be aborted	MAX timeout	SELINT
Required	Other	No	-	2



AT#FTPPUT=[<filename>[,<connMode>]]



Execution command, issued during an FTP connection, opens a data connection and starts sending <filename> file to the FTP server.

Parameters:

Name	Type	Default	Description
<filename>	string	-	name of the file (maximum length 200 characters)
<connMode>	integer	0	<p>select online or command mode:</p> <p>If online mode is selected (default) and the data connection succeeds, a CONNECT indication is sent; afterward a NO CARRIER indication is sent when the socket is closed.</p> <p>If command mode is selected and the data connection succeeds, we remain in command mode and we see the result code OK (instead of CONNECT).</p>

Values:

- 0 : online mode
- 1 : command mode

-  Use the escape sequence +++ to close the data connection.
-  The command causes an **ERROR** result code to be returned if no FTP connection has been opened yet.



AT#FTPPUT=?

Test command reports the maximum length of <filename> and the supported range of values of <connMode>.

Additional info:

- ▶▶ The format is:
#FTPPUT: <length>, (list of supported <connMode>s)

Name	Type	Default	Description
<length>	integer	-	maximum length of <filename>

3.14.13. AT#FTPPWD - FTP Print Working Directory

This command, issued during an FTP connection, shows the current working directory on FTP server.

SIM Presence	Setting saved	Can be aborted	MAX timeout	SELINT
Required	No	No	-	2



AT#FTPPWD

Execution command, issued during an FTP connection, shows the current working directory on FTP server.

-  The command causes an **ERROR** result code to be returned if no FTP connection has been opened yet.



AT#FTPPWD=?

Test command returns the **OK** result code.

3.14.14. AT#FTPRECV - Receive Data in Command Mode

The command permits the user to read a given amount of data already transferred via FTP from a remote file.

SIM Presence	Setting saved	Can be aborted	MAX timeout	SELINT
Required	Auto	No	-	2



AT#FTPRECV=<blockSize>

Execution command permits the user to transfer at most <blocksize> bytes of remote file, provided that retrieving from the FTP server has been started with a previous #FTPGETPKT command, onto the serial port.



This number is limited to the current number of bytes of the remote file which have been transferred from the FTP server.

Parameter:

Name	Type	Default	Description
<blockSize>	integer	N/A	maximum number of bytes to read

Value:

1÷3000 : maximum number of bytes to read

-  It is necessary to have previously opened FTP data port and started download and buffering of remote file through #FTPGETPKT command.
-  Issuing #FTPRECV when there is no FTP data port opened raises an error.
-  Data port will stay opened if socket is temporary waiting to receive data (#FTPRECV returns 0 and #FTPGETPTK gives an EOF 0 indication).



AT#FTPRECV?

Read command reports the number of bytes currently transferred from FTP server in the format:

#FTPRECV: <available>

Additional info:

▶▶ Parameter:

Name	Type	Default	Description
<available>	integer	-	number of transferred bytes and available for reading



AT#FTPRECV=?

Test command returns the supported values for parameter <blocksize>.



```
AT#FTPRECV?
#FTPRECV: 3000
OK
```

Read required part of the buffered data:

```
AT#FTPRECV=400
#FTPRECV:400
```

```
Text row number 1 * 11111111111111111111111111111111 *
Text row number 2 * 222222222222222222222222222222 *
Text row number 3 * 333333333333333333333333333333 *
Text row number 4 * 444444444444444444444444444444 *
Text row number 5 * 555555555555555555555555555555 *
Text row number 6 * 666666666666666666666666666666 *
Text row number 7 * 777777777777777777777777777777 *
Text row number 8 * 888888888888888888888888888888
OK
```

```
AT#FTPRECV=200
#FTPRECV:200
```

```
88888 *
Text row number 9 * 999999999999999999999999999999 *
Text row number 10 * AAAAAAAAAAAAAAAAAAAAAAAAAAAAAA *
Text row number 11 * BBBBBBBBBBBBBBBBBBBBBBBBBBBBBB *
Text row number 12 * CCCCCCCCCCCCCCCCCC
OK
```

To check when you have received complete file it is possible to use **#FTPGETPKT** read command:

```
AT#FTPGETPKT?
#FTPGETPKT:sample.txt,0,1
OK
```

(you will get <eof> set to 1)

3.14.15. AT#FTPREST - Set Restart Position for FTP GET

Set command sets the restart position for successive #FTPGET (or #FTPGETPKT) command. It permits to restart a previously interrupted FTP download from the selected position in byte.



SIM Presence	Setting saved	Can be aborted	MAX timeout	SELINT
Required	Auto	No	-	2



AT#FTPREST=[<restartPosition>]

Parameter:

Name	Type	Default	Description
<restartPosition>	integer	-	position in byte of restarting for successive #FTPGET (or #FTPGETPKT)

-  It is necessary to issue #FTPTYPE=0 before successive #FTPGET (or #FTPGETPKT command) to set binary file transfer type.
-  Setting <restartPosition> takes effect on successive FTP download. After successive successfully initiated #FTPGET (or #FTPGETPKT) command <restartPosition> is automatically reset.
-  Value set for <restartPosition> takes effect on next data transfer (data port opened by #FTPGET or #FTPGETPKT). Then <restartPosition> value is automatically assigned to 0 for next download.



AT#FTPREST?

Read command returns the current <restartPosition>:

#FTPREST:<restartPosition>



AT#FTPREST=?

Test command returns the **OK** result code.

3.14.16. AT#FTPPTO - FTP Time Out

Set the FTP time out.

SIM Presence	Setting saved	Can be aborted	MAX timeout	SELINT
Required	No	No	-	2



AT#FTPPTO=[<tout>]

Set command sets the time out used when opening either the FTP control channel or the FTP traffic channel.

Parameter:

Name	Type	Default	Description
<tout>	integer	100	time out in 100 milliseconds units

Value:

100÷5000 : hundreds of milliseconds



AT#FTPPTO?

Read command returns the current FTP operations time out in the format:

#FTPPTO: <tout>



AT#FTPPTO=?

Test command returns the supported values of parameter <tout>.

3.14.17. AT#FTPTYPE - FTP Type

This command sets the FTP file transfer type.

SIM Presence	Setting saved	Can be aborted	MAX timeout	SELINT
Not required	No	No	-	2



AT#FTPTYPE=[<type>]

Set command, issued during a FTP connection, sets the file transfer type.

Parameter:

Name	Type	Default	Description
<type>	integer	N/A	file transfer type

Values:

- 0 : binary
- 1 : ASCII



The command causes an **ERROR** result code to be returned if no FTP connection has been opened yet.



AT#FTPTYPE?

Read command returns the current file transfer type, in the format:

#FTPTYPE: <type>



AT#FTPTYPE=?

Test command returns the range of available values for parameter <type>:

#FTPTYPE: (0,1)

3.14.18. AT#FTPCFG - FTP Configuration

This command sets the time-out used when opening either the FTP control channel or the FTP traffic channel.

SIM Presence	Setting saved	Can be aborted	MAX timeout	SELINT
Required	No	No	-	2



AT#FTPCFG=<tout>,<IPPignoring>[,<FTPSEn>[,<FTPext>]]

Parameters:

Name	Type	Default	Description
<tout>	integer	100	time out in 100 milliseconds units
Value:			
100-5000 : hundreds of ms			
<IPPignoring>	integer	N/A	enable or disable IP private ignoring
Values:			
0 : No IP Private ignoring. During a FTP passive mode connection client uses the IP address received from server, even if it is a private IPV4 address.			
1 : IP Private ignoring enabled. During a FTP passive mode connection if the server sends a private IPV4 address the client doesn't consider this and connects with server using the IP address used in #FTPOPEN.			
<FTPSEn>	integer	0	disable FTPS security
Value:			
0 : disable FTPS security: all FTP commands will perform plain FTP connections.			
<FTPext>	integer	1	PORT/PASV and EPRT/EPST commands. Option added to pass-through firewall that is unaware of the extended FTP commands for #FTPPUT, #FTPLIST, #FTPAPP, #FTPGET.
Values:			
0 : always use EPRT and EPST commands			
1 : if both module and server ipv4 use PORT and PASV commands			



If parameter **<tout>** is omitted the behavior of set command is the same as read command.



AT#FTPCFG?

Read command reports the currently selected parameters in the format:

#FTPCFG: <tout>,<IPPignoring>,<FTPSEn>,<FTPext>



AT#FTPCFG=?

Test command reports the supported range of values for parameter(s): **<tout>**, **<IPPignoring>**, **<FTPSEn>**, and **<FTPext>**.

3.15. SMTP

3.15.1. AT#ESMTP - E-mail SMTP Server

This command allows to set the SMTP server address for e-mail sending.

SIM Presence	Setting saved	Can be aborted	MAX timeout	SELINT
Not required	Auto	No	-	2



AT#ESMTP=<smtp>

Set command sets the SMTP server address, used for sending e-mails. SMTP server can be specified as IP address or as nick name.

Parameter:

Name	Type	Default	Description
<smtp>	string	-	SMTP server address. This parameter can be either: <ul style="list-style-type: none"> any valid IP address in the format: "xxx.xxx.xxx.xxx" any host name to be solved with a DNS query in the format: <host name> (factory default is the empty string "").



The SMTP server used shall be inside the APN space (the SMTP server provided by the network operator) or it must allow the relay, otherwise the command will refuse to send the e-mail.



AT#ESMTP?

Read Command reports the current SMTP server address, in the format:

#ESMTP: <smtp>



AT#ESMTP=?

Test command returns the max length for the parameter <smtp>.



Example of SMTP server format name:

```
AT#ESMTP="smtp.mydomain.com"
OK
```

3.15.2. AT#EMAILMSG - SMTP Read Message

The command returns the last response from SMTP server.

SIM Presence	Setting saved	Can be aborted	MAX timeout	SELINT
Not required	Other	No	-	2



AT#EMAILMSG

Execution command returns the last response from SMTP server.



AT#EMAILMSG=?

Test command returns the **OK** result code.

3.15.3. AT#SMTPCFG - Configure SMTP Parameters

Configure SMTP parameters

SIM Presence	Setting saved	Can be aborted	MAX timeout	SELINT
Not required	Auto	No	-	2



AT#SMTPCFG=<ssl_enabled>[,<port>[,<mode>[,<unused1>[,<unused2>[,<cid>]]]]]

Sets the parameters needed to the SMTP connection

Parameters:

Name	Type	Default	Description
<ssl_enabled>	integer	0	Numeric parameter indicating if the SSL encryption is enabled
Values:			
0 : SSL encryption disabled			
1 : SSL encryption enabled			
2 : SSL encryption enabled with STARTTLS SMTP command			
<port>	string	25	SMTP port to contact
Value:			
1÷65535 : SMTP ports to contact			
<mode>	integer	0	SMTP start session command
Values:			
0 : SMTP start session command HELO			
1 : SMTP start session command EHLO			
<unused1>	integer	0	for future purposes
Value:			
0 : use this value			
<unused2>	integer	0	for future purposes
Value:			
0 : use this value			
<cid>	integer	N/A	PDP context identifier. Refer to additional info section for default value.
Value:			
1÷6 : available value			

Additional info:

►► **<cid>** default value.

The default value of this parameter depends on the software customization as shown in the following table.

Software customization	<cid> default value
Verizon	3
All other	1

- i** The SSL encryption can be enabled only if **<Enable>** parameter of **#SSLEN** is set to 0, **<FTPSEn>** parameter of **#FTPCFG** is set to 0 and **<ssl_enabled>** parameter of **#HTTPCFG** is set to 0

**AT#SMTPCFG?**

Returns the current settings in the format:

#SMTPCFG:<ssl_enabled>,<port>,<mode>,0,0,<cid><CR><LF>

**AT#SMTPCFG=?**

Returns the supported range of parameters **<ssl_enabled>**, **<port>**, **<mode>** in the format:

#SMTPCFG:(list of supported<ssl_enabled>s),(list of supported <port>s), (list of supported <mode>s),(0), (0) ,(list of supported <cid>s)

3.15.4. AT#ERST - E-mail Parameters Reset

This execution command resets the e-mail parameters to the "factory default" configuration.

SIM Presence	Setting saved	Can be aborted	MAX timeout	SELINT
Not required	No	No	-	2



AT#ERST

The e-mail parameters to reset are:

- E-mail User Name
- E-mail Password
- E-mail Sender Address
- E-mail SMTP server



AT#ERST=?

Test command returns the **OK** result code.

3.15.5. AT#ESAV - E-mail Parameters Save

This execution command stores the e-mail parameters in the NVM.

SIM Presence	Setting saved	Can be aborted	MAX timeout	SELINT
Not required	No	No	-	2



AT#ESAV

The e-mail parameters that are stored are:

- E-mail User Name
- E-mail Password
- E-mail Sender Address
- E-mail SMTP server



AT#ESAV=?

Test command returns the **OK** result code.



If a parameter value has not been previously specified using the e-mail parameters setting commands, like **#EADDR**, then a default value will be taken.

3.15.6. AT#EUSER - E-mail Authentication User Name

This command sets the user identification string to be used during the SMTP authentication step.

SIM Presence	Setting saved	Can be aborted	MAX timeout	SELINT
Not required	Other	No	-	2



AT#EUSER=[<eUser>]

Parameter:

Name	Type	Default	Description
<eUser>	string	""	string containing the e-mail authentication User ID

Value:

"" : factory default

 If no authentication is required then the <eUser> parameter must be the empty string "".



AT#EUSER?

Read command returns the value of the current user identification string <e-user>, in the format:

#EUSER: <eUser>



AT#EUSER=?

Test command returns the maximum allowed length of the string parameter <eUser>



```
AT#EUSER="myE-Name"
OK
```

```
AT#EUSER?
#EUSER: "myE-Name"
OK
```

3.15.7. AT#EMAILD - E-mail Sending

This command sends an e-mail message.

SIM Presence	Setting saved	Can be aborted	MAX timeout	SELINT
Not required	No	No	-	2



AT#EMAILD=[<da>,<subj>]

A PDP context shall have been activated through **AT#SGACT=x,1**. The context "x" is the one used by SMTP, as specified by **#SMTPCFG** command. After command line is terminated with **<CR>**, the device responds sending a four character sequence prompt:



<CR><LF><greater_than><space> (see IRA character set: 13, 10, 62, 32)

To complete the operation, send **Ctrl-Z** char (**0x1A** hex). To exit without completing the operation send **ESC** char (**0x1B** hex).

If the e-mail message is successfully sent, then the response is **OK**. If message sending fails for some reason, an error code is reported.

Parameters:

Name	Type	Default	Description
<da>	string	-	destination address (maximum length 100 characters).
<subj>	string	-	subject of the message (maximum length 100 characters).

-  If the length of one of the string type parameters exceeds the maximum length, then module returns an error indication.
-  Care must be taken to ensure that during the command execution, no other commands are issued: to avoid malfunctions it is suggested to wait for the **OK** or **ERROR / +CMS ERROR:<err>** response before issuing further commands.
-  Maximum length for message body is 1500: trying to send more data will cause the surplus to be discarded and lost.



AT#EMAILD=?

Test command returns **OK** result code.



```
AT#EMAILD="me@myaddress.com","subject of the mail"
>message body... . This is the text of the mail message
CTRL-Z
... wait...
OK
Message has been sent.
```

3.15.8. AT#EPASSW - E-mail Authentication Password

This command sets the password string to be used during the authentication step of the SMTP.

SIM Presence	Setting saved	Can be aborted	MAX timeout	SELINT
Not required	Auto	No	-	2



AT#EPASSW=[<ePwd>]

Parameter:

Name	Type	Default	Description
<ePwd>	string	""	e-mail authentication password that can have any string value up to max length reported by test command

Value:

"" : factory default



If no authentication is required then the <ePwd> parameter shall be empty "".



AT#EPASSW=?

Test command returns the maximum allowed length of the string parameter <ePwd>.



```
AT#EPASSW="myPassword"
OK
```

3.15.9. AT#EADDR - E-mail Sender Address

This command sets the sender address string to be used for sending the e-mail.

SIM Presence	Setting saved	Can be aborted	MAX timeout	SELINT
Not required	Auto	No	-	2



AT#EADDR=[<eAddr>]

Parameter:

Name	Type	Default	Description
<eAddr>	string	""	sender address. This parameter can be set to any string with any length up to the one reported by the test command.

Value:

"" : default value



AT#EADDR?

Read command reports the current sender address, in the format:

#EADDR: <eAddr>



AT#EADDR=?

Test command returns the maximum allowed length of the string parameter <eAddr>.



The examples describe how to set and get the sender e-mail address.

- Set the sender e-mail address.
AT#EADDR="me@email.box.com"
OK
- Get sender e-mail address.
AT#EADDR?
#EADDR: "me@email.box.com"
OK

<timeout>	integer	120	timeout, data from HTTPS server.
Value:			
1÷65535	:		time interval in seconds to wait for receiving data from HTTP server.
<cid>	integer	-	PDP context identifier. See +CGDCONT command.
<pkt_size>	integer	0	size for data sending (#HTTPSND) or receiving (#HTTPCV).
Values:			
0	:		select automatically value 300
1÷1500	:		send or receive size in bytes
<unused1>	integer	-	parameter for future use. Must be set to 0.
<unused2>	integer	-	parameter for future use. Must be set to 0.

- A special form of the set command, **AT#HTTPCFG=<prof_id>**, causes the values for profile number **<prof_id>** to reset to default values.
- Only one profile can use the SSL encryption.



AT#HTTPCFG?

Read command returns the current settings for each defined profile in the format:

#HTTPCFG:<prof_id>,<server_address>,<server_port>,<auth_type>,<username>,<password>,<ssl_enabled>,<timeout>,<cid>,<pkt_size>,0,0<CR><LF>[<CR><LF>

#HTTPCFG:<prof_id>,<server_address>,<server_port>,<auth_type>,<username>,<password>,<ssl_enabled>,<timeout>,<cid>,<pkt_size>,0,0]<CR><LF>[...]



AT#HTTPCFG=?

Test command returns the supported range of parameters **<prof_id>**, **<server_port>**, **<auth_type>**, **<ssl_enabled>**, **<timeout>**, **<cid>**, **<pkt_size>**, **<unused1>**, **<unused2>**, and the maximum length of **<server_address>**, **<username>** and **<password>** parameters in the format:

#HTTPCFG:(list of supported <prof_id>s),<s_length>,(list of supported <server_port>s), (list of supported <auth_type>s),<u_length>,<p_length>,(list of supported <ssl_enabled>s),(list of supported <timeout>s),(list of supported <cid>s),(list of supported <pkt_size>s),(0),(0)

Additional info:

- ▶▶ Meaning of the **<..._length>** parameters:

Name	Type	Default	Description
<s_length>	integer	-	maximum length of parameter <server_address>
<u_length>	integer	-	maximum length of parameter <username> .
<p_length>	integer	-	maximum length of parameter <password> .

3.16.2. AT#HTTPQRY - Send HTTP GET, HEAD or DELETE Request

This command performs a GET, HEAD or DELETE request to HTTP server.



Standard RFC 2616

SIM Presence	Setting saved	Can be aborted	MAX timeout	SELINT
Not required	Auto	No	-	2



AT#HTTPQRY=<prof_id>,<command>,<resource>[,<extra_header_line>]

Parameters:

Name	Type	Default	Description
<prof_id>	integer	N/A	profile identifier
	Value:		
	0=2	:	identifier values
<command>	integer	0	identifies command requested to HTTP server
	Values:		
	0	:	GET
	1	:	HEAD
	2	:	DELETE
<resource>	string	-	is the HTTP resource (URI), object of the request
<extra_header_line>	string	-	is the optional HTTP header line

Additional info:

- ▶▶ When the HTTP server answer is received, then the following URC is put on the serial port:

#HTTPRING: <prof_id>,<http_status_code>,<content_type>,<data_size>

If there are no data from server or the server does not answer within the time interval specified in **<timeout>** parameter of **#HTTPCFG** command, then the URC **#HTTPRING <http_status_code>** parameter has value 0.

Name	Type	Default	Description
<http_status_code>	string	-	is the status code, as received from the server, see RFC 2616
<content_type>	string	-	reports the "Content-Type" header line, as received from the server, see RFC 2616
<data_size>	string	-	is the byte amount of data received from the server. If the server does not report the "Content-Length:" header line, the parameter value is 0.

- ▶▶ To set more than one HTTP header line in parameter **<extra_header_line>**, they have to be separated by ">>"

Example:

AT#HTTPQRY=0,0, "myURI", "Content-Type: xyz>>Authorization: something"

- i If sending ends successfully, the response is **OK**; otherwise an error code is reported. The HTTP request header sent with **#HTTPQRY** always contains the "Connection: close" line, and it cannot be removed.



AT#HTTPQRY=?

Test command reports the supported range of values for the parameters **<prof_id>** and **<command>** and the maximum length of **<resource>** parameter in the format:

#HTTPQRY:(list of supported <prof_id>s),(list of supported <command>s),<r_length>, <m_length>

Additional info:

- ▶▶ Meaning of **<..._length>** parameters:

Name	Type	Default	Description
<r_length>	integer	-	maximum length of parameter <resource> .
<m_length>	integer	-	maximum length of parameter <extra_header_line> .

3.16.3. AT#HTTPSND - Send HTTP POST or PUT request

This command performs a POST or PUT request to HTTP server and starts sending data to the server.

SIM Presence	Setting saved	Can be aborted	MAX timeout	SELINT
Required	No	No	-	2



AT#HTTPSND=<profilid>,<command>,<resource>,<dataLen>[,<postParam>[,<extraHeaderLine>]]

After entering **AT#HTTPSND=...** command, and terminated the command line with <CR>, the module returns the following three characters sequence prompt, and waits for data to send:

<greater_than><greater_than><greater_than> (see IRA character set: 62, 62, 62)

Now, data can be entered from TE, sized <dataLen> bytes. If sending ends successfully the response will be **OK**, otherwise an error code will be reported.

When the HTTP server answer is received, the URC will be available on the serial port with the following format:

#HTTPRING: <profilid>,<httpStatusCode>,<contentType>,<dataSize>

The URC parameters are described in Unsolicited Field section.

Parameters:

Name	Type	Default	Description
<profilid>	integer	N/A	profile identifier
	Value:		
	0÷2	:	profile identifier
<command>	integer	N/A	command requested to HTTP server
	Values:		
	0	:	POST command
	1	:	PUT command
<resource>	string	-	HTTP resource (uri), object of the request
<dataLen>	integer	-	data length to send in bytes
<postParam>	string	N/A	HTTP Content-type identifier, used only for POST command, optionally followed by colon character (:) and a string that extends with sub-types the identifier
	Values:		
	1[:extension]	:	"text/plain" with optional extension
	2[:extension]	:	"application/octet-stream" with optional extension
	3[:extension]	:	"multipart/form-data" with optional extension
	other	:	free string corresponding to other content type and possible sub-types
<extraHeaderLine>	string	-	optional HTTP header line

Unsolicited fields:

Name	Type	Description
<httpStatusCode>	integer	status code, as received from the server (see RFC 2616)
<contentType>	string	"Content-Type" header line, as received from the server (see RFC 2616)
<dataSize>	integer	byte amount of data received from the server (if the server doesn't report the "Content-Length:" header line, the parameter value is 0)

- i** The HTTP request header sent with **#HTTPSND** always contains the "Connection: close" line, and it cannot be removed.
- i** If there are no data from server or the server doesn't answer within the time interval specified in <timeout> parameter of **#HTTPCFG** command, then the URC **#HTTTPRING** <http_status_code> parameter will have value 0.



AT#HTTPSND=?

Test command returns the supported range of parameters <profilid>, <command> and <dataLen> and the maximum length of <resource>, <postParam> and <extraHeaderLine> string parameters in the format:

HTTPSND: (list of supported <profilid>s),(list of supported <command>s), <rLength>, (list of supported <dataLen>s),<pLength>,<mLength>

Additional info:

▶▶ <...Length> parameters meaning:

Name	Type	Default	Description
<rLength>	integer	-	maximum length of parameter <resource>
<pLength>	integer	-	maximum length of parameter <postParam>
<mLength>	integer	-	maximum length of parameter <extraHeaderLine>



POST commands examples.

- Post 100 byte without "Content-type" header
AT#HTTPSND=0,0,"/",100
 >>>
- Post 100 byte with "application/x-www-form-urlencoded"
AT#HTTPSND=0,0,"/",100,0
 >>>
- Post 100 byte with "multipart/form-data" and extension
AT#HTTPSND=0,0,"/",100,"3:boundary=----FormBoundary"
 >>>

3.16.4. AT#HTTTPRCV - Receive HTTP Server Data

This command permits the user to read data from HTTP server in response to a previous HTTP module request.

SIM Presence	Setting saved	Can be aborted	MAX timeout	SELINT
Required	No	No	-	2



AT#HTTTPRCV=<profilid>[,<maxByte>]

The module is notified of these data by the #HTTTPRING URC.



The device shall prompt a three-character sequence followed by the data:

<less_than><less_than><less_than> (see IRA character set: 60,60,60)

If reading ends successfully, the response is **OK**; otherwise an error code is reported.

Parameters:

Name	Type	Default	Description
<profilid>	integer	N/A	profile identifier
	Value:		
	0÷2	:	profile identifier
<maxByte>	integer	0	max number of bytes to read at a time
	Value:		
	0,	:	0 means infinite size.
	64÷1500		

-  If <maxByte> is unspecified, server data will be transferred all in once.
-  If the data are not present or the #HTTTPRING <httpStatusCode> parameter has value 0, an error code is reported.



AT#HTTTPRCV=?

Test command reports the supported range of values for <profilid> and <maxByte> parameters in the format:

HTTTPRCV: (list of supported <profilid>s,<maxByte>)

3.17. SSL

3.17.1. AT#SSLCFG - Configure General Parameters of a SSL Socket

This command configures SSL connection parameters.

SIM Presence	Setting saved	Can be aborted	MAX timeout	SELINT
Not required	Auto	No	-	2



AT#SSLCFG=<SSId>,<cid>,<pktSz>,<maxTo>,<defTo>,<txTo>[,<skipHostMismatch>[,<unused2>[,<unused3>[,<unused4>]]]]

Set command allows configuring SSL connection parameters.

Parameters:

Name	Type	Default	Description
<SSId>	integer	1	Secure Socket Identifier
Value:			
1 : Until now SSL block manages only one socket			
<cid>	integer	-	PDP context identifier, see +CGDCONT command.
<pktSz>	integer	0	packet size to be used by the SSL/TCP/IP stack for data sending
Values:			
0 : select automatically default value (300)			
1÷1500 : number of bytes			
<maxTo>	integer	90	exchange timeout or socket inactivity timeout. In online mode, if there's no data exchange within this timeout period, the connection is closed.
Values:			
0 : no timeout			
1÷65535 : timeout in seconds			
<defTo>	integer	100	timeout that will be used by default whenever the corresponding parameter of each command is not set.
Value:			
10÷5000 : timeout in tenth of seconds			
<txTo>	integer	50	data sending timeout. In online mode, after this period data are sent also if they're less than max packet size.
Values:			
0 : no timeout			
1÷255 : timeout value in hundreds of milliseconds			
<skipHostMismatch>	integer	1	enables/disables Host Mismatch alert

Values:

0 : do not ignore

1 : ignore

<unused2>	mixed	-	unused
<unused3>	mixed	-	unused
<unused4>	mixed	-	unused

 If secure socket is not enabled using **#SLEN** only test requests can be made.



AT#SSLCFG?

Read command reports the parameters current values in the format:

#SSLCFG:<SSId>,<cid>,<pktSz>,<maxTo>,<defTo>,<txTo>,<skipHostMismatch>,0,0,0



AT#SSLCFG=?

Test command reports the ranges of all parameters values.

3.17.2. AT#SSLSECCFG - Configure Security Parameters of a SSL Socket

This command allows configuring SSL connection parameters.

SIM Presence	Setting saved	Can be aborted	MAX timeout	SELINT
Required	Auto	No	-	2



AT#SSLSECCFG=<SSId>,<CipherSuite>,<auth_mode>

Parameters:

Name	Type	Default	Description
<SSId>	integer	1	Secure Socket Identifier

Value:

- 1 : Until now only one SSL socket is available

<CipherSuite>	integer	0	cipher suite
---------------	---------	---	--------------

Values:

- 0 : cipher suite is chosen by remote server among the following:
 TLS_RSA_WITH_AES_128_CBC_SHA,
 TLS_RSA_WITH_AES_256_CBC_SHA,
 TLS_RSA_WITH_3DES_EDE_CBC_SHA,
 TLS_DHE_RSA_WITH_AES_128_CBC_SHA,
 TLS_DHE_RSA_WITH_3DES_EDE_CBC_SHA,
 TLS_DHE_RSA_WITH_AES_256_CBC_SHA,
 TLS_RSA_WITH_AES_128_CBC_SHA256,
 TLS_DHE_RSA_WITH_AES_128_CBC_SHA256,
 TLS_RSA_WITH_AES_256_CBC_SHA256,
 TLS_DHE_RSA_WITH_AES_256_CBC_SHA256
- 1 : TLS_RSA_WITH_RC4_128_MD5
- 2 : TLS_RSA_WITH_RC4_128_SHA
- 3 : TLS_RSA_WITH_AES_128_CBC_SHA
- 4 : TLS_RSA_WITH_NULL_SHA
- 5 : TLS_RSA_WITH_AES_256_CBC_SHA
- 6 : TLS_RSA_WITH_3DES_EDE_CBC_SHA
- 7 : TLS_DHE_RSA_WITH_AES_128_CBC_SHA
- 8 : TLS_DHE_RSA_WITH_3DES_EDE_CBC_SHA
- 9 : TLS_DHE_RSA_WITH_AES_256_CBC_SHA
- 10 : TLS_RSA_WITH_AES_128_CBC_SHA256
- 11 : TLS_DHE_RSA_WITH_AES_128_CBC_SHA256
- 12 : TLS_RSA_WITH_AES_256_CBC_SHA256
- 13 : TLS_DHE_RSA_WITH_AES_256_CBC_SHA256

<auth_mode>	integer	0	authentication mode
-------------	---------	---	---------------------

Values:

- 0 : SSL Verify None
- 1 : manage server authentication

2 : manage server and client authentication if requested by the remote server

 Server CA certificate must be stored through **#SSLSECDATA**.

 If secure socket is not enabled using **#SLEN** command, only test command can be used.



AT#SSLSECCFG?

Read command reports the currently selected parameters in the format:

#SSLSECCFG: <SSId>,<CipherSuite>,<auth_mode>

Read command returns **ERROR** if secure socket has not been enabled using **#SLEN** command.



AT#SSLSECCFG=?

Test command returns the range of supported values for all the parameters.

3.17.3. AT#SSLEN - Enable a SSL Socket

This command activates/deactivates a socket secured by SSL.



SIM Presence	Setting saved	Can be aborted	MAX timeout	SELINT
Required	Auto	No	-	2



AT#SSLEN=<SSId>,<Enable>

Parameters:

Name	Type	Default	Description
<SSId>	integer	1	Secure Socket Identifier
Value:			
1 : only one socket is available			
<Enable>	integer	0	activate/deactivate secure socket
Values:			
0 : deactivate			
1 : activate			

-  If the unique available secure socket is not activated, all the commands - belonging to the SSL set (example: #SSLSECDATA, #SSL..., etc.) and different from test commands - return an error message. #SSLS command is an exception, it can be issued also if the socket is deactivated.
-  If the unique available secure socket is connected, it cannot be deactivated issuing AT#SSLEN=1,0.



AT#SSLEN?

Read command reports the current status of secure socket in the format:

```
#SSLEN: <SSId>,<Enable>
OK
```



AT#SSLEN=?

Test command returns the range of supported values for all the parameters:

```
#SSLEN: (1),(0,1)
```

3.17.4. AT#SSLD - Open a SSL Socket to a Remote Server

This command opens a remote connection via socket secured through SSL.

SIM Presence	Setting saved	Can be aborted	MAX timeout	SELINT
Required	Other	No	-	2



AT#SSLD=<SSId>,<rPort>,<IPAddress>,<ClosureType>[,<connMode>[,<Timeout>]]

Execution command opens a remote connection via socket secured through SSL.

Parameters:

Name	Type	Default	Description
<SSId>	integer	1	Secure Socket Identifier
Value:			
1 : Until now only one SSL socket is available			
<rPort>	integer	1	Remote TCP port to contact
Value:			
1÷65535 : TCP port number			
<IPAddress>	string	-	address of SSL server.
<ClosureType>	integer	0	Closure type
Value:			
0 : Until now only closure type 0 is supported. SSL session id and keys are free.			
<connMode>	integer	1	connection mode
Values:			
0 : online mode connection, see Additional info section.			
1 : command mode connection, see Additional info section.			
<Timeout>	integer	100	It represents the maximum allowed TCP inter-packet delay. It means that, when more data is expected during the handshake, the module awaits <Timeout> * 100 msec for the next packet. If no more data can be read, the module gives up the handshake and raises an ERROR response.
<Timeout> is the total handshake timeout or, in other words, it is not the absolute maximum time between the #SSLD issue and the CONNECT/OK/ERROR response. Though by changing this parameter you can limit the handshake duration (for example in case of congested network or busy server), there is no way to be sure to get the command response within a certain amount of time, because it depends on the TCP connection time, the handshake time and the computation time (which depends on the authentication mode and on the size of keys and certificates).			
Value:			
1÷5000 : hundreds of ms			

Additional info:

- ▶▶ **<connMode>=2**: online mode connection
 If **<connMode>** is set to **online mode connection** and the command is successful, the module enters into **online data mode** and returns the intermediate result code **CONNECT**. After the **CONNECT**, you can suspend the direct interface to the socket connection (the socket stays open) using the escape sequence (**+++**): the module moves back to **command mode** and returns the final result code **OK** after the suspension.
 After such a suspension, it is possible to resume it by using the **#SSLO** command with the corresponding **<connId>**.

- ▶▶ **<connMode>=1**: command mode connection
 If **<connMode>** is set to **command mode connection** and the command is successful, the socket is opened, the module remains in **command mode** and returns result code **OK**.

- ❗ If secure socket is not enabled using **#SSLEN** only test requests can be made.
- ❗ If timeout is not set for SSL connection the default timeout value, set by **#SSLCFG**, is used.
- ❗ In online mode the socket is closed after an inactivity period (configurable with **#SSLCFG**, with a default value of 90 seconds), and the **NO CARRIER** message is printed.
- ❗ In online mode data are transmitted as soon as the data packet size is reached or as after a transmission timeout. Both these parameters are configurable by using **#SSLCFG**.
- ❗ Before opening a SSL connection, the PDP context must have been activated by **#SGACT=x,1**
- ❗ Before opening a SSL connection, make sure to have stored the needed secure data (CA certificate), using **#SSLSECDATA**, for the security level set through **AT#SSLSECCFG**.
- ❗ The PDP context definition that will be used, is set by **AT#SSLCFG** command



AT#SSLD=?

Test command returns the range of supported values for all the parameters:

#SSLD: (1),(1-65535),,(0),(0,1),(1-5000)



Start command mode:

```
AT#SSLD=1,8500,"84.94.194.21",0,1  
OK
```

Start online mode:

```
AT#SSLD =1,8500,"84.94.194.21",0,0  
OK  
CONNECT
```

Configure correct PDP context with AT#SSLCFG command:

```
AT#SGACT=3,1  
#SGACT: XX.XXX.XXX.XXX  
OK
```

** Note the second parameter of #SSLCFG **

```
AT#SSLCFG=1,3,300,90,100,50,0,0,0,0  
OK
```

```
AT#SSLD=1,<port>,"IP or URL",0,0  
CONNECT
```

3.17.5. AT#SSLO - Restore a SSL Socket after a +++

This command restores a SSL connection (online mode) suspended by an escape sequence (+++).

SIM Presence	Setting saved	Can be aborted	MAX timeout	SELINT
Not required	No	No	-	2



AT#SSLO=<SSId>



This command restores a SSL connection (online mode) suspended by an escape sequence (+++). After the connection restore, the **CONNECT** message is printed. Please note that this is possible even if the connection has been started in command mode (**#SSLD** with **<connMode>=1**).

Parameter:

Name	Type	Default	Description
<SSId>	integer	1	Secure Socket Identifier

Value:

1 : only one socket is available.

-  If secure socket has not be enabled through **#SLEN** command, only test command can be used.
-  Before opening a SSL connection, the PDP context must have been activated by **AT#SGACT=X,1**.
-  If an error occurs during reconnection the socket cannot be reconnected, then a new connection has to be done.



AT#SSLO=?

Test command returns the range of supported values for all the parameters:

#SSLO: (1)

3.17.6. AT#SSLH - Close a SSL Socket

This command allows closing the SSL connection.

SIM Presence	Setting saved	Can be aborted	MAX timeout	SELINT
Required	No	No	-	2



AT#SSLH=<SSId>[,<ClosureType>]

Parameters:

Name	Type	Default	Description
<SSId>	integer	1	Secure Socket Identifier
Value:			
1 : only one socket is available			
<ClosureType>	integer	0	type of socket closure.
Value:			
0 : only value 0 is supported			



If secure socket has not be enabled through **#SLEN** command, only test command can be used.



AT#SSLH=?

Test command returns the range of supported values for all the parameters:

#SSLH: (1),(0)

3.17.7. AT#SSLSEND - Send Data through a SSL Socket

This command allows sending data through a secure socket.

SIM Presence	Setting saved	Can be aborted	MAX timeout	SELINT
Required	No	No	-	2



AT#SSLSEND=<SSId>[,<Timeout>]

Parameters:

Name	Type	Default	Description
<SSId>	integer	1	Secure Socket Identifier
Value:			
1 : only one socket is available			
<Timeout>	integer	100	socket send timeout
Value:			
1÷5000 : timeout in 100 ms units			

Additional info:

- ▶▶ After command line is terminated with <CR>, the command returns the following four-character sequence prompt:

<CR><LF><greater_than><space> (IRA 13, 10, 62, 32)

and waits for the data to be send.

- to end the data editing and start the sending, enter Ctrl-Z char (0x1A hex). The maximum number of bytes to send is 1023, trying to send more data will cause the data excess to be discarded and lost.
- to exit without sending the message, enter ESC char (0x1B hex).

If data are successfully sent, the command returns **OK**. If data sending fails, an error code is reported.

 If secure socket has not be enabled through **#SSLEN** command, only test command can be used.

 If timeout is not set for SSL connection, is used the timeout value set by **#SSLCFG**.

 Before sending data through the SSL connection, it must be established using **#SSLD**.



AT#SSLSEND=?

Test command returns the range of supported values for all the parameters.

3.17.8. AT#SSLRECV - Read Data from a SSL Socket

This command reads data from a SSL socket.

SIM Presence	Setting saved	Can be aborted	MAX timeout	SELINT
Required	No	No	-	2



AT#SSLRECV=<SSId>,<MaxNumByte>[,<Timeout>]

Set command allows to receive data, arrived through a connected secure socket. Data has been buffered and not read yet.

Parameters:

Name	Type	Default	Description
<SSId>	integer	1	secure socket identifier
Value:			
1 : until now only one SSL socket is supported			
<MaxNumByte>	integer	N/A	maximum number of bytes to read
Value:			
1÷1000 : maximum number of bytes to read			
<Timeout>	integer	100	time-out in 100 ms units
Value:			
1÷5000 : hundreds of ms			

Additional info:

- ▶▶ If data are received, the device responds:



```
#SSLRECV: NumByteRead
...(Data read)...
OK
```

- ▶▶ If no data are received, the device responds:

```
#SSLRECV: 0
TIMEOUT
OK
```

- ▶▶ If the remote host closes the connection, the device responds:

```
#SSLRECV: 0
DISCONNECTED
OK
```

-
-  If secure socket is not enabled using **AT#SSLEN**, only test requests can be made.
 -  If timeout is not set for SSL connection, the default timeout value, set through **AT#SSLCFG**, is used.
 -  Before receiving data from the SSL connection, it has to be established using **AT#SSLD**.
-

**AT#SSLRCV=?**

The test command returns the ranges of the parameters values in the form:

#SSLRCV: (1),(1-1000),(10-5000)

3.17.9. AT#SSLS - Report the Status of a SSL Socket

This command reports the status of secure sockets.

SIM Presence	Setting saved	Can be aborted	MAX timeout	SELINT
Required	No	No	-	2



AT#SSLS=<SSId>

The command reports the status of secure sockets. The response message of the command can have the following formats:

if secure socket is connected, the format is:

#SSLS: <SSId>,<ConnectionStatus>,<CipherSuite>

otherwise:

#SSLS: <SSId>,<ConnectionStatus>

The response messages parameters are described in the Additional info section.

Parameter:

Name	Type	Default	Description
<SSId>	integer	1	Secure Socket Identifier.

Value:

1 : only one SSL socket is supported

Additional info:

- ▶▶ List of the meaning of the response message parameters.

Name	Type	Default	Description
<CipherSuite>	integer	0	Cipher Suite identifier

Values:

- 0 : Chiper Suite is chosen by remote Server
- 1 : TLS_RSA_WITH_RC4_128_MD5
- 2 : TLS_RSA_WITH_RC4_128_SHA
- 3 : TLS_RSA_WITH_AES_256_CBC_SHA
- 4 : TLS_RSA_WITH_AES_128_CBC_SHA

<ConnectionStatus>	integer	N/A	Connection Status identifier
--------------------	---------	-----	------------------------------

Values:

- 0 : socket disabled
- 1 : connection closed
- 2 : connection open

 This command can be issued even if the <SSId> is not enabled.



AT#SSLS=?

Test command returns the ranges of the parameters values in format:

#SSLS: (1)



- AT#SSLS=1
#SSLS: 1,1
OK
- AT#SSLS=1
#SSLS: 1,2,0
OK

3.17.10. AT#SSLI - Secure Socket Info

This command is used to get information about secure socket data traffic.

SIM Presence	Setting saved	Can be aborted	MAX timeout	SELINT
Required	Auto	No	-	2



AT#SSLI[=<SSId>]

Execution command is used to get information about secure socket data traffic. The response is in the format:

#SSLI: <SSId>,<DataSent>,<DataRecv>,<PendingData>,<TCPConnWaitingAck>

Parameter:

Name	Type	Default	Description
<SSId>	integer	1	Secure Socket Identifier

Value:

1 : only one SSL socket is available

Additional info:

- Parameters returned by the response message and not described in the previous sections.

Name	Type	Default	Description
<DataSent>	integer	-	total amount (in bytes) of data sent to the TLS/SSL connection since the beginning of the connection itself (obviously: not yet encoded into TLS/SSL record)
<DataRecv>	integer	-	total number of bytes received from the TLS/SSL connection since the beginning of the connection itself (obviously: already decoded from TLS/SSL record)
<PendingData>	integer	-	number of bytes available to be read from the TLS/SSL record that is currently being processed (obviously: already decoded from TLS/SSL record)
<TCPConnWaitingAck>	integer	N/A	indication of the underlying TCP socket condition, if there are TCP/IP packets sent but not yet acknowledged or not

Values:

0 : no TCP/IP packets sent waiting for ack

1 : TCP/IP packets sent waiting for ack



AT#SSLI=?

Test command returns the range of supported values for all the parameters.

#SSLI: (1)

3.17.11. AT#SSLSENDEXT - Send Data through a SSL Socket in Command Mode

This command sends data through a secure socket.

SIM Presence	Setting saved	Can be aborted	MAX timeout	SELINT
Not required	No	No	-	2



AT#SSLSENDEXT=<SSId>,<bytestosend>[,<Timeout>]

Execution command sends data through a secure socket.

After command line is terminated with <CR>, the command returns the following four-character sequence prompt:

<CR><LF><greater_than><space> (see IRA 13, 10, 62, 32)

and waits for the data to be send.

When <bytestosend> bytes have been sent, the sending is automatically completed. If data are successfully sent, the command returns **OK**. If data sending fails, an error code is reported.

Parameters:

Name	Type	Default	Description
<SSId>	integer	N/A	Secure Socket Identifier
Value:			
1 : only one SSL socket is available.			
<bytestosend>	string	-	number of bytes to be sent. Refer to test command for range
<Timeout>	integer	100	time-out in 100 ms units.
Value:			
1÷1500 : hundreds of ms.			



If secure socket has not be enabled through **#SSLEN** command, only test command can be used.



If timeout is not set for SSL connection, is used the timeout value set by **#SSLCFG**.



Before sending data through the SSL connection, it must be established using **#SSLD**.



All special characters are sent like a generic byte. For instance: 0x08 BS (Backspace) is sent through the socket, it does not delete the previous character.



AT#SSLSENDEXT=?

Test command returns the range of supported values for parameters <SSId>, <bytestosend> and <Timeout>.



Open the socket in command mode:

```
AT#SSLD=1,443,<port>,"IP address",0,1  
OK
```

Send data specifying total number of bytes:

```
AT#SSLSENDEXT=1,256,100  
>...
```

3.17.12. AT#SSLSECDATA - Manage the Security Data

The command stores, reads, and deletes security data (Certificate, CA certificate, private key) in / from NVM.

SIM Presence	Setting saved	Can be aborted	MAX timeout	SELINT
Required	Auto	No	-	2



AT#SSLSECDATA=<SSId>,<action>,<dataType>[,<size>]

Parameters:

Name	Type	Default	Description
<SSId>	integer	1	Secure Socket Identifier.
	Value:		
	1	:	Until now only one SSL socket is available
<action>	integer	0	required action
	Values:		
	0	:	delete data from NVM
	1	:	store data in NVM
	2	:	read data from NVM
<dataType>	integer	0	security data type
	Values:		
	0	:	certificate
	1	:	CA certificate
	2	:	RSA Private key. Private keys with password are not supported
<size>	integer	N/A	size of security data to be stored. The parameter is mandatory if write action is issued, can be omitted for delete or read actions.
	Value:		
	1÷4095	:	size

Additional info:

►► Store security data in NVM

<action>=1 specifies the storing in NVM, **<size>** parameter is mandatory. After command line is terminated with **<CR>**, the command returns the following four-character sequence prompt:

<CR><LF><greater_than><space> (see IRA 13, 10, 62, 32)

and waits for data to be store. Security data must be in PEM format:

- to end the secured data editing, enter Ctrl-Z char (0x1A hex)
- to exit without writing the message, enter ESC char (0x1B hex)

If data are successfully stored, the command returns **OK**, otherwise an error code is reported.



►► Read security data from NVM

<action>=2 specifies the reading from NVM, the <size> parameter is not mandatory. The command returns the following message:

```
#SSLSECDATA: <SSId>,<dataType>
<DATA>
OK
```

If the required security data has not been stored in NVM (or it has been deleted) the response has the following format:

```
#SSLSECDATA: <SSId>,<dataType>
No data stored
OK
```

-  If secure socket has not be enabled through **#SLEN** command, only test command can be used.
-  If socket is connected an error code is reported.
-  Only "rsa_sign" certificates are supported by the Telit Module in client authentication. The remote server must support this certificate type, otherwise the handshake will fail.



AT#SSLSECDATA?

Read command reports what security data are stored. The returned message has the following format:

```
#SSLSECDATA: <SSId>,<CertIsSet>,<CACertIsSet>,<PrivKeyIsSet>
```

<CertIsSet>, <CACertIsSet>, <PrivKeyIsSet> are 1 if related data are stored into NVM otherwise 0.

Additional info:

- This Additional info section describes the parameters returned by the **AT#SSLSECDATA?** read command.

Name	Type	Default	Description
<CertIsSet>	integer	0	identifies the certificate presence in the NVM
Values:			
0	:	not present	
1	:	present	

<CAcertIsSet>	integer	0	identifies the CA certificate presence in the NVM
Values:			
	0	:	not present
	1	:	present

<PrivKeysSet>	integer	0	identifies the RSA Private key presence in the NVM
Values:			
	0	:	not present
	1	:	present

**AT#SSLSECDATA=?**

Test command returns the supported values for all the parameters.

3.17.13. AT#SSLSECCFG2 - Configure Additional Parameters of a SSL Socket

This command allows configuring additional SSL security parameters.

SIM Presence	Setting saved	Can be aborted	MAX timeout	SELINT
Required	Auto	No	-	2



AT#SSLSECCFG2=<SSId>,<unused_A>,<SNI>[,<unused_B>[,<unused_C>[,<unused_D>]]]

Parameters:

Name	Type	Default	Description
<SSId>	integer	N/A	Secure Socket Identifier
Value:			
1 : only one SSL socket is available			
<unused_A>	mixed	-	reserved for future implementations
<SNI>	integer	0	enable/disable Service Name Indication
Values:			
0 : SNI disabled			
1 : SNI enabled			
<unused_B>	mixed	-	reserved for future implementations
<unused_C>	mixed	-	reserved for future implementations
<unused_D>	mixed	-	reserved for future implementations



AT#SSLSECCFG2?

Read command reports the currently selected parameters in the format:

#SSLSECCFG2: <SSId>,0,<SNI>,0,0,0



AT#SSLSECCFG2=?

Test command reports the range of supported values for all the parameters.

3.18. Easy Scan

3.18.1. AT#CSURV - Network Survey

The command performs a survey on the selected band channels.

SIM Presence	Setting saved	Can be aborted	MAX timeout	SELINT
Not required	No	No	-	2



AT#CSURV[=<s>,<e>]]

Execution command performs a quick survey on channels belonging to the band selected by last #BND command issue, starting from channel <s> to channel <e>.

Issuing AT#CSURV<CR>, a full band scan is performed. The command responds with the following string:

Network survey started...

After a while, a list of network survey information text lines, one for each received carrier, is reported. The format of network survey information text lines depends on technology (2G or 4G) and BCCH (BCCH-Carrier or non BCCH-Carrier).

The #CSURV output ends in two ways, depending on the last #CSURVF setting.

If AT#CSURVF=0 or AT#CSURVF=1 the output will end with the string:

- **Network survey ended**

If AT#CSURVF=2 the output will end with the string:

- **Network survey ended (Carrier: <NoARFCN> BCCh: <NoBCCh>)**

The network survey information text lines are described in the Additional info sections.

Parameters:

Name	Type	Default	Description
<s>	integer	-	starting channel, see note section.
<e>	integer	-	ending channel, see note section.

Additional info:

▶▶ 2G Networks, for BCCH-Carrier

Network survey information text lines:

```
arfcn: <arfcn> bsic: <bsic> rxLev: <rxLev> ber: <ber> mcc: <mcc> mnc: <mnc>
lac: <lac> cellId: <cellId> cellStatus: <cellStat> numArfcn: <numArfcn> arfcn:
<CR><LF><CR><LF><CR><LF>
```

Name	Type	Default	Description
<arfcn>	integer	-	C0 carrier assigned radio channel (BCCH - Broadcast Control Channel)
<bsic>	integer	-	base station identification code; if #CSURVF last setting is 0, <bsic> is a decimal number, else it is at the most a 2-digits octal number
<rxLev>	integer	-	decimal number; it is the reception level (in dBm)

<ber>	integer	-	always 0, dummy parameter
<mcc>	hex	-	hexadecimal 3-digits number; it is the mobile country code
<mnc>	hex	-	hexadecimal 2-digits number; it is the mobile network code
<lac>	integer	-	location area code; if #CSURVF last setting is 0, <lac> is a decimal number, else it is a 4-digits hexadecimal number
<cellId>	integer	-	cell identifier; if #CSURVF last setting is 0, <cellId> is a decimal number, else it is a 4-digits hexadecimal number
<cellStat>	string	N/A	cell status

Values:

- CELL_SUITABLE : C0 is a suitable cell
- CELL_LOW_PRIORITY : the cell is low priority based on the received system information
- CELL_FORBIDDEN : the cell is forbidden
- CELL_BARRED : the cell is barred based on the received system information
- CELL_LOW_LEVEL : the cell <rxLev> is low
- CELL_OTHER : none of the above (e.g. exclusion timer running, no BCCH available, etc.)

<numArfcn>	integer	-	always 0, dummy parameter
-------------------------	---------	---	---------------------------

►► 2G Networks, for non BCCH-Carrier

Network survey information text lines:

arfcn: <arfcn> **rxLev:** <rxLev>
 <CR><LF><CR><LF><CR><LF>

Name	Type	Default	Description
<arfcn>	integer	-	decimal number; it is the RF channel
<rxLev>	integer	-	decimal number; it is the reception level (in dBm)

►► 4G Networks

Network survey information text lines:

for serving cell:

earfcn: <earfcn> **rxLev:** <rxLev> **mcc:** <mcc> **mnc:** <mnc> **cellId:** <cellId> **tac:** <tac>

for neighbor cell:

earfcn: <earfcn> **rxLev:** <rxLev> **cellId:** <cellId>

Name	Type	Default	Description
<earfcn>	integer	-	E-UTRA Assigned Radio Channel

<tac> string - Tracking Area Code. If **#CSURVF** last setting is 0, **<cellid>** is a decimal number, else it is a 4-digits hexadecimal number

▶▶ **#CSURV** end output parameters if **AT#CSURVF=2**:

Network survey ended (Carrier: <NoARFCN> BCCh: <NoBCCh>)

Name	Type	Default	Description
<NoARFCN>	integer	-	number of scanned frequencies
<NoBCCH>	integer	-	number of found BCCH



2G Network

<s> and **<e>** parameters can assume the values shown in the Channels Ranges column, according to the module in use.

Channels Ranges	GSM Bands
0,124	GSM900
975,1023	GSM900
512,885	DCS1800
128,251	GSM850
512,810	PCS1900

4G Network

<s> and **<e>** parameters can assume the values shown in the Channels Ranges column, according to the module in use.

Channels Ranges	LTE Bands
0,599	1
600,1199	2
1200,1949	3
1950,2399	4
2400,2649	5
3450,3799	8
5010,5179	12
5180,5279	13
5850,5999	18
6000,6149	19
6150,6449	20
8690,9039	26
9210,9659	28



- 2G Network, for BCCH-Carrier

AT#CSURV

Network survey started ...

**arfcn: 1018 bsic: 21 rxLev: -71 ber: 0.00 mcc: 222 mnc: 01 lac: 54717 cellId:
14887 cellStatus: CELL_SUITABLE numArfcn: 0 arfcn:**

**arfcn: 1009 bsic: 10 rxLev: -85 ber: 0.00 mcc: 222 mnc: 01 lac: 54717 cellId:
21093 cellStatus: CELL_SUITABLE numArfcn: 0 arfcn:**

...

Network survey ended

OK

- 4G Network

AT#CSURV

Network survey started ...

earfcn: 5230 rxLev: -56 mcc: 311 mnc: 480 cellId: 120 tac: 39681

earfcn: 5230 rxLev: -66 cellId: 410

Network survey ended

OK

3.18.2. AT#CSURVC - Network Survey (Numeric Format)

This command performs a survey on the selected band channels. The return message uses only the numeric format.

SIM Presence	Setting saved	Can be aborted	MAX timeout	SELINT
Not required	No	No	-	2



AT#CSURVC[=[<s>,<e>]]

Execution command performs a quick survey on channels belonging to the band selected by last #BND command issue, starting from channel <s> to channel <e>. The information provided by this command is the same as that provided by #CSURV command. The difference is that the output of #CSURV is in numeric format only, the parameters names are not reported

Issuing AT#CSURC<CR>, a full band scan is performed. The command responds with the following string:

Network survey started...

After a while, a list of network survey information text lines in numeric format, one for each received carrier, is reported. The format of network survey information text lines depends on technology (2G or 4G) and BCCH (BCCH-Carrier or non BCCH-Carrier).

The #CSURVC output ends in two ways, depending on the last #CSURVF setting.

If AT#CSURVF=0 or AT#CSURVF=1 the output will end with the string:

- **Network survey ended**

If AT#CSURVF=2 the output will end with the string:

- **Network survey ended (Carrier: <NoARFCN> BCCh: <NoBCCh>)**

The network survey information text lines are described in the Additional info sections.

Parameters:

Name	Type	Default	Description
<s>	integer	-	starting channel, see #CSURV command.
<e>	integer	-	ending channel, see #CSURV command.

Additional info:

▶▶ 2G Networks, for BCCH-Carrier

Network survey information text lines:

```
<arfcn>,<bsic>,<rxLev>,<ber>,<mcc>,<mnc>,<lac>,<cellId>,<cellStat>,<numArfcn>
<CR><LF><CR><LF><CR><LF>
```

Name	Type	Default	Description
<arfcn>	integer	-	C0 carrier assigned radio channel (BCCH - Broadcast Control Channel)
<bsic>	integer	-	base station identification code; if #CSURVF last setting is 0, <bsic> is a decimal number, else it is at the most a 2-digits octal number
<rxLev>	integer	-	decimal number; it is the reception level (in dBm)
<ber>	integer	-	always 0, dummy parameter

<mcc>	hex	-	hexadecimal 3-digits number; it is the mobile country code
<mnc>	hex	-	hexadecimal 2-digits number; it is the mobile network code
<lac>	integer	-	location area code; if #CSURVF last setting is 0, <lac> is a decimal number, else it is a 4-digits hexadecimal number
<cellId>	integer	-	cell identifier; if #CSURVF last setting is 0, <cellId> is a decimal number, else it is a 4-digits hexadecimal number
<cellStat>	string	N/A	cell status

Values:

CELL_SUITABLE	:	C0 is a suitable cell
CELL_LOW_PRIORITY	:	the cell is low priority based on the received system information
CELL_FORBIDDEN	:	the cell is forbidden
CELL_BARRED	:	the cell is barred based on the received system information
CELL_LOW_LEVEL	:	the cell <rxLev> is low
CELL_OTHER	:	none of the above (e.g. exclusion timer running, no BCCH available, etc.)

<numArfcn>	integer	-	always 0, dummy parameter
-------------------------	---------	---	---------------------------

►► 2G Networks, for non BCCH-Carrier

Network survey information text lines:

```
<arfcn>,<rxLev>
<CR><LF><CR><LF><CR><LF>
```

Name	Type	Default	Description
<arfcn>	integer	-	decimal number; it is the RF channel
<rxLev>	integer	-	decimal number; it is the reception level (in dBm)

►► 4G Networks

Network survey information text lines:

for serving cell:

```
<earfcn>,<rxLev>,<mcc>,<mnc>,<cellId>,<tac>
```

for neighbor cell:

```
<earfcn>,<rxLev>,<cellId>
```

Name	Type	Default	Description
<earfcn>	integer	-	E-UTRA Assigned Radio Channel.

<tac>	integer	-	Tracking Area Code. If #CSURVF last setting is 0, <cellid> is a decimal number, else it is a 4-digits hexadecimal number.
--------------------	---------	---	---

▶▶ **#CSURV** end output parameters if **AT#CSURVF=2**:

Network survey ended (Carrier: <NoARFCN> BCCh: <NoBCCh>)

Name	Type	Default	Description
<NoARFCN>	integer	-	number of scanned frequencies
<NoBCCH>	integer	-	number of found BCCH



2G Network, for BCCH-Carrier

AT#CSURVC

Network survey started ...

1018,21,-73,0.00,222,01,54717,14887,0,0

1023,50,-78,0.00,222,01,54717,14886,0,0

1009,10,-85,0.00,222,01,54717,21093,0,0

...

Network survey ended

OK

3.18.3. AT#CSURVF - Network Survey Format

The command configures the numbers format used in the messages related to the surveying of the network bands channels.

SIM Presence	Setting saved	Can be aborted	MAX timeout	SELINT
Not required	No	No	-	2



AT#CSURVF=[<format>]

Set command configures the numbers format in each information text line of the network survey message (Easy Scan®).

Parameter:

Name	Type	Default	Description
<format>	integer	0	format of the numbers in each network survey information text line

Values:

- 0 : Decimal
- 1 : Hexadecimal values, no text
- 2 : Hexadecimal values with text



AT#CSURVF?

Read command reports the current format of the numbers in each network survey information text line, as follows:

#CSURVF: <format>



AT#CSURVF=?

Test command reports the supported range of values for the parameter <format>.

3.18.4. AT#CSURVNLF - Network Survey CR LF Removing

This command enables/disables the automatic <CR><LF> removing from each network survey information text line.

SIM Presence	Setting saved	Can be aborted	MAX timeout	SELINT
Not required	No	No	-	2



AT#CSURVNLF=[<value>]

Parameter:

Name	Type	Default	Description
<value>	integer	0	enables/disables the automatic <CR><LF> removing from each network survey information text line

Values:

- 0 : disables <CR><LF> removing; they will be present in the information text line
- 1 : enables <CR><LF> removing from information text line



AT#CSURVNLF?

Read command reports whether the automatic <CR><LF> removing from each network survey information text line is currently enabled or not, in the format:

<value>



AT#CSURVNLF=?

Test command reports the range of values for parameter <value>.

3.18.5. AT#CSURVEXT - Extended Network Survey

The command is present only for backward compatibility.

SIM Presence	Setting saved	Can be aborted	MAX timeout	SELINT
Not required	No	No	-	2



AT#CSURVEXT=[<value>]

Parameter:

Name	Type	Default	Description
<value>	integer	0	dummy parameter

Values:

- 0 : dummy value
- 1 : dummy value
- 2 : dummy value



AT#CSURVEXT?

Read command reports current dummy value.

#CSURVEXT: <value>



AT#CSURVEXT=?

Test command reports the range of values for dummy parameter <value>.

3.19. CloT Optimization

3.19.1. AT+CCIOTOPT - CloT Optimization Configuration

This command controls CloT EPS (Cellular Internet of Things, Evolved Packet System) optimizations.



3GPP TS 27.007

SIM Presence	Setting saved	Can be aborted	MAX timeout	SELINT
Not required	Auto	No	-	2



AT+CCIOTOPT=[<n>[,<supportedUEopt>[,<preferredUEopt>]]]

The set command controls which CloT EPS optimizations the UE indicates as supported and preferred in the ATTACH REQUEST and TRACKING AREA UPDATE REQUEST messages. The command also allows reporting of the CloT EPS optimizations that are supported by the network; an unsolicited result code is used to indicate the supported CloT EPS optimizations by the network:

+CCIOTOPT!: <supportedNetworkopt>

For parameter meaning refer to Unsolicited code values.

Parameters:

Name	Type	Default	Description
<n>	integer	0	enables or disables reporting of unsolicited result code +CCIOTOPT! :
Values:			
0	:	Disable reporting	
1	:	Enable reporting	
3	:	Disable reporting and reset the parameters for CloT EPS optimization to the default values	
<supportedUEopt>	integer	0	indicates the UE's support for CloT EPS optimizations.
Values:			
0	:	No support	
1	:	Support for control plane CloT EPS optimization (default value for modules supporting NBloT technology)	
2	:	Support for user plane CloT EPS optimization	
3	:	Support for both control plane CloT EPS optimization and user plane CloT EPS optimization	
<preferredUEopt>	integer	0	indicates the UE's preference for CloT EPS optimizations.
Values:			
0	:	No preference	
1	:	Preference for control plane CloT EPS optimization	
2	:	Preference for user plane CloT EPS optimization	

Unsolicited field:

Name	Type	Description
<supportedNetworkopt>	integer	indicates the Network support for CloT EPS optimizations. Values: 0 : No support. 1 : Support for control plane CloT EPS optimization 2 : Support for user plane CloT EPS optimization 3 : Support for both control plane CloT EPS optimization and user plane CloT EPS optimization



AT+CCIOTOPT?

Read command returns the current parameter values in the format:

+CCIOTOPT :<n>,<supportedUEopt>,<preferredUEopt>



AT+CCIOTOPT=?

Test command reports the range for the parameters in the format:

+CCIOTOPT: (list of supported <n>s),(list of supported <supportedUEopt>s),(list of supported <preferredUEopt>s)

3.20. IoT Portal

3.20.1. AT#LWM2MSTAT - Telit LwM2M Client Current Status

This command sends a query about the status to the Telit LwM2M client.

SIM Presence	Setting saved	Can be aborted	MAX timeout	SELINT
Required	Auto	No	-	2



AT#LWM2MSTAT

If executed, the command returns the current Telit LwM2M client status. The status is returned through the string:

#LWM2MGETSTAT: <enabledStatus>,<status>

Additional info:

▶▶ Here are described the string parameters.

Name	Type	Default	Description
<enabledStatus>	integer	N/A	the current Telit LwM2M client enabling status
Values:			
0	:		the client is disabled
1	:		the client is enabled
<status>	string	N/A	the current internal status
Values:			
DIS	:		the client is disabled
WAIT	:		waiting for the user's ACK
ACTIVE	:		after the ACK, the session is currently active
IDLE	:		there is not an active session currently
DEREG	:		the client is deregistering



AT#LWM2MSTAT?

Not supported



AT#LWM2MSTAT=?

Test command returns **OK**.

3.20.2. AT#LWM2MMON - Activate/Deactivate the LwM2M Resource

This command can be used to activate/deactivate the resource changes monitoring. Resource change could be performed by the server's write and by the #LWM2MW or #LWM2MSET commands.

SIM Presence	Setting saved	Can be aborted	MAX timeout	SELINT
Required	Auto	No	-	2



AT#LWM2MMON=<action>,<objectID>

By inserting an <objectID> in the monitoring list with <action> in active mode, each time a resource belonging to the object under monitoring changes, the user - according to the setting performed with #LWM2MMON - receives an URC reporting the complete URI path of the resource changed in the format:

#LWM2MMON: UPD,"/<objectID>/<objectInstanceID>/<resourceID>/ <resourceInstanceID>"

Parameters:

Name	Type	Default	Description
<action>	integer	0	activate/deactivate the resource monitoring
Values:			
0 : deactivate			
1 : activate			
<objectID>	integer	N/A	object identifier. This command is not applicable to: <ul style="list-style-type: none"> object 0 "Security"
Value:			
1÷65535 : object identifier range			



The list of monitorable <objectID> is limited to 6. After that number, it is not possible to monitor any further object unless another object already present in list is removed.



AT#LWM2MMON?

Read command reports the list of currently supported objects, in the format:

#LWM2MMON: "<objectID₁>"

#LWM2MMON: "<objectID₂>"

...

The <objectID_n> are listed according to their insertion order in the list.



AT#LWM2MMON=?

Test command reports the supported range of values for the parameters.

3.20.3. AT#LWM2MENA - Enable/Disable Telit LwM2M Agent

This command enables/disables the Telit LwM2M Client feature.

SIM Presence	Setting saved	Can be aborted	MAX timeout	SELINT
Required	No	No	-	2



AT#LWM2MENA=<en>[,<pdpld>[,<mode>[,<guardRequestTime>[,<guardReleaseTime>]]]]

Execution command enables/disables the Telit LwM2M Client feature. Enabling the client with <mode> set to 1 will produce the following URCS:

#LWM2MRING: <ring>

#LWM2MEND: <endResultCode>

Parameters:

Name	Type	Default	Description
<en>	integer	0	enable/disable the Telit LwM2M Client feature
Values:			
0 : disable			
1 : enable			
<pdpld>	integer	1	PDP context identifier the Telit LwM2M client should use on the module
Value:			
1÷6 : PDP context identifier			
<mode>	integer	0	ACK modality
Values:			
0 : no ACK required			
1 : ACK required			
<guardRequestTime>	integer	5	in case of update registration and Notify events, it is the time of advance for the ACK notification
Value:			
1÷100 : time of advance for the ACK notification, in seconds			
<guardReleaseTime>	integer	5	the client waits this time to manage further LwM2M server request before releasing the network data resource (emitting #LWM2MEND: URC)
Value:			
1÷100 : time to wait to release the network resource, in seconds			

Additional info:

- ▶▶ The Telit LwM2M client show also an URC according to some events, in the form:
#LWM2MINFO: <infoType>,<infoEvent>





- The Telit LwM2M client show also URCs according to the server registration status, in the form:

#LWM2M-TLT: <event>,<SSID>,<URL>

Unsolicited fields:

Name	Type	Description
<ring>	string	the ring code enabled by the <mode> parameter set to 1 Values: REG : the client needs to register UPD : registration update to be sent SMS : wake up SMS received from the server DRG : deregistration
<endResultCode>	integer	the result code transmitted by the #LWM2MEND URC Value: 0 : success
<infoType>	string	the type of information communicated by the client Value: GEN : general info
<infoEvent>	string	the event communicated with the #LWM2MINFO URC Values: FOTA REBOOT : a reboot occurring during FW upgrade DEV REBOOT : a reboot issued by LwM2M server (exec 3/0/4)
<event>	string	event name Values: BOOTSTRAPPING : the client is starting the bootstrap to the specified server BOOTSTRAPPED : the client finished successfully the bootstrap to the specified server REGISTERING : the client is starting the DM connection to the specified server REGISTERED : the client finished successfully the DM connection to the specified server SUSPENDED : the client suspended successfully the DM connection to the specified server, as requested via /1/x/4 execution resource

		CLIENT_DISABLED	:	the client has been disabled by AT command or by internal failures (i.e.: handshake failure)
		FORCE_EXIT	:	the client failed the server connection and after the proper retries, it is stopped. This action is only manageable by a module reboot.
<SSID>	integer	the short server ID code		
<URL>	string	the server URL		

-  The service registration URC service is not active by default: it is in charge of the user to activate it. Nevertheless, the bootstrap is always notified once the context has been activated.
-  "CLIENT_DISABLED" and "FORCE_EXIT" <event> do not report <SSID> and <URL>
-  Please notice that the URC reporting "FORCE_EXIT" <event> are always displayed, even in case of inactive service or in case of non-Telit clients.
-  During the PDP activation or deactivation triggered by the #LWM2MENA command, the client shall not manage any other #LWM2M commands for a short period of time.
-  If the client LwM2M is already enabled, a further enabling attempt will return an error.

**AT#LWM2MENA?**

If the client is enabled, read command reports the current values of parameters in the format:

#LWM2MENA: <en>,<pdpld>,<mode>,<guardRequestTime>,<guardReleaseTime>

If the client is not enabled, read command reports the current values of parameters in the format:

#LWM2MENA: 0

**AT#LWM2MENA=?**

Test command reports the supported range of values for all the parameters.



Server URC examples:

- Bootstrap session successful

```
AT#LWM2MENA=1
OK

LWM2M-TLT:"BOOTSTRAPPING",SSID=0,"coaps://bs-engr.telit.io:5684"
LWM2M-TLT:"BOOTSTRAPPED",SSID=0,"coaps://bs-engr.telit.io:5684"
```
- Bootstrap session failure

```
AT#LWM2MENA=1
OK

LWM2M-TLT:"BOOTSTRAPPING",SSID=0,"coaps://bs-engr.telit.io:5684"
LWM2M-TLT:"BOOTSTRAPPING",SSID=0,"coaps://bs-engr.telit.io:5684"
LWM2M-TLT:"BOOTSTRAPPING",SSID=0,"coaps://bs-engr.telit.io:5684"
LWM2M-TLT:"FORCE_EXIT"
```
- the registration/deregistration to each server is shown only if the service is enabled:

```
AT#LWM2MENA=1
OK

LWM2M-TLT:"REGISTERING",SSID=99,"coaps://engr-api.devicewise.com"
LWM2M-TLT:"REGISTERING",SSID=102,"coap://217.114.209.230:5683"
LWM2M-TLT:"REGISTERED",SSID=102,"coap://217.114.209.230:5683"
LWM2M-TLT:"REGISTERED",SSID=99,"coaps://engr-api.devicewise.com"

AT#LWM2MENA=0
OK

LWM2M-TLT:"DEREGISTERED",SSID=99,"coaps://engr-api.devicewise.com"
LWM2M-TLT:"DEREGISTERED",SSID=102,"coap://217.114.209.230:5683"
LWM2M-TLT:"CLIENT_DISABLED"
```
- DM failure (i.e.: for handshake problems), the status is shown only if the service is enabled:

```
LWM2M-TLT:"REGISTERING",SSID=99,"coaps://engr-api.devicewise.com"
LWM2M-TLT:"FORCE_EXIT"
LWM2M-TLT:"CLIENT_DISABLED"
```
- client suspending:

```
LWM2M-TLT:"REGISTERING",SSID=99,"coaps://engr-api.devicewise.com"
LWM2M-TLT:"REGISTERED",SSID=99,"coaps://engr-api.devicewise.com"
... execution of resource /1/x/4
LWM2M-TLT:"SUSPENDED",SSID=99,"coaps://engr-api.devicewise.com"
... after timeout as in resource /1/x/5
LWM2M-TLT:"REGISTERING",SSID=99,"coaps://engr-api.devicewise.com"
LWM2M-TLT:"REGISTERED",SSID=99,"coaps://engr-api.devicewise.com"
```

3.20.4. AT#LWM2MACK - Ack for Telit LwM2M Agent

This command sends an ACK to the Telit LwM2M Client.

SIM Presence	Setting saved	Can be aborted	MAX timeout	SELINT
Required	No	No	-	2



AT#LWM2MACK=<action>

if the <mode> in #LWM2MENA is not 0, the Telit LwM2M client requires an ACK to performs its operations on the dedicated data context.

Parameter:

Name	Type	Default	Description
<action>	integer	1	Acknowledge: the <cid> context indicated in #LWM2MENA command is active and the user allows the client to send data through this.

Value:

1 : action is required



AT#LWM2MACK?

Not supported



AT#LWM2MACK=?

Test command reports the supported range of values for all the parameters.

3.20.5. AT#LWM2MR - LWM2M Client Resource Reading

This set command selects the parameters for the read operation on the lwm2m agent, it requires the correspondent lwm2m agent enabled and working.

SIM Presence	Setting saved	Can be aborted	MAX timeout	SELINT
Required	Auto	No	-	2



AT#LWM2MR=<agentInstance>,<objectID>,<objectInstanceID>,<resourceID>,<resourceInstanceID>

Parameters:

Name	Type	Default	Description
<agentInstance>	integer	0	selects the lwm2m instance shown below
Values:			
0	:	Telit agent	
1	:	Verizon agent	
2	:	AT&T agent	
3,4	:	reserved for future use	
<objectID>	integer	N/A	select object identifier. The following objects could not be accessed by the command:
<ul style="list-style-type: none"> • '0', Security object • '1', Server object • '2', Access Control object • '5', Firmware Update object 			
Value:			
0÷65535	:	object identifier range	
<objectInstanceID>	integer	N/A	select object instance identifier for the query
Value:			
0÷65535	:	object instance identifier range	
<resourceID>	integer	N/A	select resource identifier
Value:			
0÷65535	:	resource identifier range	
<resourceInstanceID>	integer	N/A	select resource instance identifier
Value:			
0÷65535	:	resource instance identifier range	

 The command returns an **ERROR** if the selected resource is not readable.



AT#LWM2MR?

Read command return **OK** code



AT#LWM2MR=?

Test command reports the range for parameters

3.20.6. AT#LWM2ME - LWM2M Client Resource Executing

This set command selects the parameters to execute operations on the lwm2m agent, it requires the correspondent lwm2m agent enabled and working.

SIM Presence	Setting saved	Can be aborted	MAX timeout	SELINT
Required	No	No	-	2



AT#LWM2ME=<agentInstance>,<objectID>,<objectInstanceID>,<resourceID>,<resourceInstanceID>

Parameters:

Name	Type	Default	Description
<agentInstance>	integer	0	selects the lwm2m instance shown below
Values:			
0	:	Telit agent	
1	:	Verizon agent	
2	:	AT&T agent	
3,4	:	reserved for future use	
<objectID>	integer	N/A	select object identifier. The following objects could not be accessed by the command:
<ul style="list-style-type: none"> • '0', Security object • '1', Server object • '2', Access Control object • '5', Firmware Update object 			
Value:			
0÷65535	:	select object range	
<objectInstanceID>	integer	N/A	select object Instance identifier for the query
Value:			
0÷65535	:	object Instance identifier range	
<resourceID>	integer	N/A	select resource identifier
Value:			
0÷65535	:	resource identifier range	
<resourceInstanceID>	integer	N/A	selects the resource instance identifier
Value:			
0÷65535	:	resource instance identifier range	

 The command returns an **ERROR** if the selected resource is not executable.



AT#LWM2ME?

Read command return **OK** code



AT#LWM2ME=?

Test command reports the range for parameters

3.20.7. AT#LWM2MW - LWM2M Client Resource Writing

This set command selects the parameters for the write operation on the lwm2m agent, it requires the correspondent lwm2m agent enabled and working.

SIM Presence	Setting saved	Can be aborted	MAX timeout	SELINT
Required	Auto	No	-	2



AT#LWM2MW=<agentInstance>,<objectID>,<objectInstanceID>,<resourceID>,<resourceInstanceID>,<value>

Parameters:

Name	Type	Default	Description
<agentInstance>	integer	0	selects the lwm2m instance shown below
Values:			
0	:	Telit agent	
1	:	Verizon agent	
2	:	AT&T agent	
3,4	:	reserved for future use	
<objectID>	integer	N/A	selects the object identifier to be selected. The following objects could not be accessed by the command:
<ul style="list-style-type: none"> • '0', Security object • '1', Server object • '2', Access Control object • '5', Firmware Update object 			
Value:			
0÷65535	:	object identifier range	
<objectInstanceID>	integer	N/A	selects the object Instance identifier for the query
Value:			
0÷65535	:	object Instance identifier range	
<resourceID>	integer	N/A	selects the resource identifier
Value:			
0÷65535	:	resource identifier range	
<resourceInstanceID>	integer	N/A	selects the resource instance identifier
Value:			
0÷65535	:	resource instance identifier range	
<value>	mixed	-	data to be written in the selected node. Data type should be chosen according to the resource data type.

i The command returns an **ERROR** if the selected resource is not writable.



AT#LWM2MW?

Read command return **OK** code



AT#LWM2MW=?

Test command reports the range for parameters.

3.20.8. AT#LWM2MSTS - LWM2STS Bootstrap Server

This command selects the server that will be used at the next module's reboot. It could be used to restore the module in case of mismatch between client and server info (i.e.: like PSK key or identity). The command requires the correspondent lwm2m agent enabled and working.

SIM Presence	Setting saved	Can be aborted	MAX timeout	SELINT
Required	Auto	No	-	2



AT#LWM2MSTS=<agentInstance>[,<serverURI>[,<URI>[,<isBootstrapServer>]]]

Parameters:

Name	Type	Default	Description
------	------	---------	-------------

<agentInstance>	integer	0	selects the lwm2m instance shown below. Issuing the command with only the <agentInstance> parameter will reset a formerly set server, restoring the condition to the factory default.
------------------------------	---------	---	--

Values:

- 0 : Telit agent
- 1 : Verizon agent
- 2 : AT&T agent

<serverURI>	integer	-	the server that will be used by the module at the next client reboot. Entries from:
--------------------------	---------	---	---

- 0 to 9 reserved for Telit's agent
- 10 to 19 reserved for VZW's agent
- 20 to 29 reserved for AT&T's agent

The correspondence table between **<serverURI>** parameter and server URI is shown in Additional info.

<URI>	string	-	URI
--------------------	--------	---	-----

<isBootstrapServer>	integer	0	selects if the requested server is a bootstrap.
----------------------------------	---------	---	---

Values:

- 0 : the specified server is not a bootstrap server
- 1 : the specified server is a bootstrap server

Additional info:

- ▶▶ Correspondence table between **<serverURI>** parameter and server URI.

<serverURI>	server URI	Note
0	"coaps://bs-engr.telit.io:5684"	Bootstrap server
10	"coaps://ddocdpboot.do.motive.com:5684"	Bootstrap server
11	"coaps://ddocdp.do.motive.com:5684"	DM server

12	"coap://ddocdp.do.motive.com:5683"	DM server
20	"coaps://xattmpct.xdev.motive.com:5684"	Bootstrap server
999	customized server URI entry	/

<serverURI> special value '999' allows the user to insert a customized server string; this string should start with "coap://" or with "coaps://" sbu-strings and may or not contain the indicated port. In case the port is not indicated, the coap(s) required service selects the proper default port.



AT#LWM2MSTS?

Read command returns **OK** result code.



AT#LWM2MSTS=?

Test command returns **OK** result code.



It selects the "coaps://bs-engr.telit.io:5684" server for the Telit agent.

AT#LWM2MSTS=0,0

It selects the " coaps://xvzwcdpiii.xdev.motive.com:5684" server for the Verizon agent.

AT#LWM2MSTS=1,10

It selects the "Leshan" test server, unsecure mode. Last parameter in this example could also be omitted.

AT#LWM2MSTS=0,999,"coap://leshan.eclipse.org:5683",0

3.20.9. AT#LWM2MSET - Set LwM2M Whitelisted Resource

This set command sets a user defined value to the specified resource, if whitelisted.

SIM Presence	Setting saved	Can be aborted	MAX timeout	SELINT
Required	Auto	No	-	2



AT#LWM2MSET=<type>,<objectID>,<objectInstanceID>,<resourceID>,<resourceInstanceID>,<value>

Parameters:

Name	Type	Default	Description
<type>	integer	N/A	the data type to be inserted
Values:			
0	:	Integer type	
1	:	Float type	
2	:	String type	
3	:	binary (inserted in HEX format)	
<objectID>	integer	N/A	select object identifier
Value:			
0÷65535	:	object identifier range	
<objectInstanceID>	integer	N/A	select object instance identifier
Value:			
0÷65535	:	object instance identifier range	
<resourceID>	integer	N/A	select resource identifier
Value:			
0÷65535	:	resource identifier range	
<resourceInstanceID>	integer	N/A	select resource instance identifier
Value:			
0÷65535	:	resource instance identifier range	
<value>	mixed	-	the value to be associated to the specified resource, see Additional info section.

Additional info:

▶▶ **<value>** data could assume the following values, according to the specified **<type>**

Name	Type	Default	Description
<value>	integer	N/A	integer values
Value:			

-2147483648:-2147483647 : values range

<value>	mixed	-	float values are accepted in positive and negative format, according to the proper float notation
<value>	string	-	string values
<value>	hex	-	binary values, introduced by the hexadecimal representation

 This command only works on whitelisted resources and objects. Currently, the whitelist is:

URI	Name	Data Type
3,0,6,0	Device Object, Available Power Sources	Integer
3,0,7,0	Device Object, Power Source Voltage	Integer
3,0,8,0	Device Object, Power Source Current	Integer
3,0,9,0	Device Object, Battery level	Integer
3,0,17,0	Device Object, Device Type	String
3,0,20,0	Device Object, Battery Status	Integer

In addition, all the “read-only” resources dynamically created by **#LWM2MNEWINST** command will be automatically whitelisted.



AT#LWM2MSET?

Read command returns **OK** code.



AT#LWM2MSET=?

Test command reports the supported range of values for the <type> parameters.

3.20.10. AT#LWM2MNEWINST - Create a New Object Instance

This command can be used to create dynamically the new <objectInstanceID> of the specified <objectID>.

SIM Presence	Setting saved	Can be aborted	MAX timeout	SELINT
Required	Auto	No	-	2



AT#LWM2MNEWINST=<agentInstance>,<objectID>,<objectInstanceID>

Execution command allows the user to create dynamically the <objectInstanceID> of the specified <objectID>. When succeed, the newly created <objectInstanceID> will have all the resources filled with default values. The user shall populate them properly, by using the #LWM2MW command for writable resources, or by the #LWM2MSET command for non-writable resources.

Parameters:

Name	Type	Default	Description
<agentInstance>	integer	0	selects the lwm2m instance shown below.
	Value:		
	0	:	Telit client
<objectID>	integer	N/A	object identifier
	Value:		<ul style="list-style-type: none"> <objectID> value 65535 is reserved only <objectID> starting from value 7 can be used to dynamically create objects
	7÷65534	:	object identifier range
<objectInstanceID>	integer	N/A	object instance identifier to be created.
	Value:		<ul style="list-style-type: none"> <objectInstanceID> value 65535 is reserved
	0÷65534	:	object instance identifier range.



AT#LWM2MNEWINST?

Read command returns **OK** code.



AT#LWM2MNEWINST=?

Test command reports the supported range of values for the parameters.

3.20.11. AT#LWM2MGET - Get LwM2M Whitelisted Resource

This command can be used to get a user defined value from a "whitelisted" resource.

SIM Presence	Setting saved	Can be aborted	MAX timeout	SELINT
Required	Auto	No	-	2



AT#LWM2MGET=<type>,<objectID>,<objectInstanceID>,<resourceID>,<resourceInstanceID>

Execution command gets a user defined value to the specified resource, if URI is whitelisted; error otherwise.

Parameters:

Name	Type	Default	Description
<type>	integer	N/A	data type to be inserted
Values:			
0	:	Integer type	
1	:	Float type	
2	:	String type	
3	:	binary (inserted in HEX format)	
<objectID>	integer	N/A	object identifier
Value:			
0÷65535	:	object identifier range	
<objectInstanceID>	integer	N/A	object instance identifier
Value:			
0÷65535	:	object instance identifier range	
<resourceID>	integer	N/A	resource identifier
Value:			
0÷65535	:	resource identifier range	
<resourceInstanceID>	integer	N/A	resource instance identifier
Value:			
0÷65535	:	resource instance identifier range	

This command only works on whitelisted resources and objects. For the object whitelist, please refer to #LWM2MSET command.



AT#LWM2MGET?

Read command returns **OK** code.



AT#LWM2MGET=?

Test command reports the supported range of values for the parameters.

3.21. Non-IP Data Delivery (NIDD)

3.21.1. AT#NIPDCFG - Define NIDD Parameters

This set command allows the TE to specify the parameters for a NIDD connection. It is supported by modules with NBloT technology.

SIM Presence	Setting saved	Can be aborted	MAX timeout	SELINT
Not required	No	No	-	2



AT#NIPDCFG=<type>,<cid>[,<userName>,<passWord>[,<unused>[,<unused>]]]

Parameters:

Name	Type	Default	Description
<type>	integer	0	Non-IP outgoing data type
Values:			
0 : MO Non-IP data type			
1 : MO Exception Non-IP data type			
<cid>	integer	-	specifies a PDP context definition, see +CGDCONT command
<userName>	string	-	user name for NIDD connection
<passWord>	string	-	password for NIDD connection
<unused>	integer	N/A	unused parameter
Value:			
0 : dummy value			
<unused>	integer	0	unused parameter
Value:			
0 : dummy value			



AT#NIPDCFG?

Read command returns the NIDD parameters, excluding **<password>**, for every defined PDP context, in the format:

#NIPDCFG: <type>,<cid>,<username>,0,0



AT#NIPDCFG=?

Test command reports the supported range of values for parameters **<type>**, **<cid>** and the maximum length for parameters **<userName>** and **<passWord>**.

3.21.2. AT#NIPDCONN - Open and Close a NIDD Connection

This command allows the TE to open and close a NIDD connection. It is supported by modules with NBloT technology.

SIM Presence	Setting saved	Can be aborted	MAX timeout	SELINT
Required	No	No	-	2



AT#NIPDCONN=<mode>

Parameter:

Name	Type	Default	Description
<mode>	integer	0	open/close the NIDD connection

Values:

- 0 : close the NIDD connection
- 1 : open the NIDD connection



AT#NIPDCONN?

Read command reports the status of the NIDD connection, in the format:

#NIPDCONN: <status>

<status> has the same meaning and values of <mode> parameter.



AT#NIPDCONN=?

Test command reports the supported range of values for parameter <mode>.

3.21.3. AT#NIPDSEND - Send MO Non-IP Data

This command allows the TE to send MO Non-IP data. It is supported by modules with NBloT technology.

SIM Presence	Setting saved	Can be aborted	MAX timeout	SELINT
Required	No	No	-	2



AT#NIPDSEND=<mode>,<data>

Parameters:

Name	Type	Default	Description
<mode>	integer	0	data format

Values:

- 0 : ASCII format string
- 1 : HEX format string

<data>	string	-	data to be send
--------	--------	---	-----------------



AT#NIPDSEND?

Test command reports the supported range of values for parameter <mode> and the maximum length of the string for parameter <data>.

3.21.4. AT#NIPDRECV - Retrieve Non-IP Data

This command allows the TE to retrieve the received MT Non-IP data. It is supported by modules with NBloT technology.

When MT Non-IP data are received, an unsolicited message is reported in the format:

#NIPDSRING: <recvdLen>

To get the data use **#NIPDRECV** command.

SIM Presence	Setting saved	Can be aborted	MAX timeout	SELINT
Required	No	No	-	2



AT#NIPDRECV=<readLen>[,<mode>]

Parameters:

Name	Type	Default	Description
<readLen>	integer	-	data length to be retrieved, see test command to get the available data length range. If <readLen>=0 the information about received data are queried, see Additional info section.

<mode>	integer	0	data format
--------	---------	---	-------------

Values:

- 0 : ASCII format string
- 1 : HEX format string

Additional info:

▶▶ <read_len>=0

The response reports the length of received data, read data and unread data, in the format:

#NIPDRECV: <totalRecvdLen>,<totalReadLen>,<unreadLen>

Name	Type	Default	Description
<totalRecvdLen>	integer	-	total length of received data
<totalReadLen>	integer	-	length of read data
<unreadLen>	integer	-	length of unread data

Unsolicited field:

Name	Type	Description
<recvdLen>	integer	length of received data



AT#NIPDRECV=?

Test command reports the supported range of values for parameter <readLen>.

3.22. FOTA & OMA

3.22.1. FOTA Legacy

3.22.1.1. AT#OTAUPW - OTA Delta Write

Execution command starts injection of a delta file into the device.

SIM Presence	Setting saved	Can be aborted	MAX timeout	SELINT
Not required	No	No	-	2



AT#OTAUPW=<size>

Parameter:

Name	Type	Default	Description
<size>	integer	-	size in bytes of data to be injected



AT#OTAUPW=?

Test command returns **OK** result code.

3.23. M2M

3.23.1. AT#M2MMKDIR - M2M File System Make Directory

This command manages the M2M File System.

SIM Presence	Setting saved	Can be aborted	MAX timeout	SELINT
Not required	No	No	-	2



AT#M2MMKDIR=<Full_dir_path>

Set command makes a new directory, the new directory name must be with the full path starting from the root ("/").

Parameter:

Name	Type	Default	Description
<Full_dir_path>	string	-	directory name with full path, quoted or unquoted string type (up to max 256 chars, case sensitive)

-  The directory can be passed between quote or without quote; directory names are case sensitive



AT#M2MMKDIR=?

Test command returns **OK** result code



```
AT#M2MMKDIR="dir1"
OK
```

3.23.2. AT#M2MBACKUP - M2M Set Backup Feature

This command manages the M2M File System and backup partition.

SIM Presence	Setting saved	Can be aborted	MAX timeout	SELINT
Not required	Auto	No	-	2



AT#M2MBACKUP=<enable>

Set command sets/resets the backup status of the executable binary file. Only the first starting file will be saved in backup partition.

Parameter:

Name	Type	Default	Description
<enable>	integer	0	set/reset the BACKUP permission

Values:

- 0 : resets BACKUP status and backup partition
- 1 : sets BACKUP status and backup will be performed after reboot



AT#M2MBACKUP?

Read command reports the BACKUP status. The report has the following format:

#M2MBACKUP: <enable>



AT#M2MBACKUP=?

Test command returns the allowed values for parameter <enable>.



Set BACKUP status
AT#M2MBACKUP=1
OK

Check what is the BACKUP status value.
AT# M2MBACKUP?
M2MBACKUP: 1
OK

3.23.3. AT#M2MRMDIR - M2M File System Remove Directory

This command removes a directory in the M2M file system.

SIM Presence	Setting saved	Can be aborted	MAX timeout	SELINT
Not required	No	No	-	2



AT#M2MRMDIR=<Full_dir_path>

Set command remove the directory identified by <Full_dir_path>, the directory name must be with the full path starting from the root ("/").

Parameter:

Name	Type	Default	Description
<Full_dir_path>	string	-	quoted directory name

-  The directory name can be passed between quote or without quote; directory names are case sensitive and can have up to 256 chars.



AT#M2MRMDIR=?

Test command returns OK result code.



If the directory <Full_dir_path> is not present, an error code is reported.
If the directory <Full_dir_path> is not empty, it is not possible to remove it and an error code is reported.



```
AT#M2MRMDIR="dir1"
OK
```

3.23.4. AT#M2MRUN - M2M Set Run File Permission

This command manages the M2M File System.

SIM Presence	Setting saved	Can be aborted	MAX timeout	SELINT
Not required	No	No	-	2



AT#M2MRUN=<mode>[,<file_bin>[,<delay>]]

Set command sets/resets the RUN file permission of the executable binary files stored in the directory /mod. It supports the multi-app feature.

Parameters:

Name	Type	Default	Description
<mode>	integer	N/A	set/reset the RUN file permission
Values:			
0÷2 : after next reboot load modes, see Additional info section			
3÷5 : immediate load modes, see Additional info section			
<file_bin>	string	-	file name for which you set the RUN file permission, its format is a quoted or unquoted string (max 63 chars, case sensitive). File name extension must be .bin. If parameter <file_bin> is not present, the setting is applied to all bin files in /mod directory.
<delay>	integer	N/A	this parameter is the <file_bin> delay parameter if the <file_bin> is present, otherwise it affects all the applications present in the /mod directory. If the parameter <delay> is not used, then there is no delay in the starting of the applications. When it is used, it is added to the current value of AppZone engine delay set with AT+M2M=4,<delay> . In immediate load mode (<mode>=3/4/5) instead, <delay> is the actual delay of the application.
Value:			
1÷60 : range of the delay expressed in seconds			

Additional info:

- ▶▶ After next reboot load modes: <mode>=0, <mode>=1, <mode>=2
Effects after reboot, the appcfg.ini file is updated

- **AT#M2MRUN=0**
NO RUN permission for all *.bin files in "/mod "
- **AT#M2MRUN=1**
RUN permission for all *.bin files in "/mod "
- **AT#M2MRUN=2,"app2.bin"**
RUN permission only for "/mod/app2.bin" file if it exists. The RUN permission of all other *.bin files are not changed

-
- **AT#M2MRUN=1,,10**
RUN permission for all *.bin in "/mod " with delay =10s for all
 - **AT#M2MRUN=1,"app2.bin"**
RUN permission for "/mod /app2.bin" if it exists, current delay not changed
 - **AT#M2MRUN=1,"app3.bin",0**
RUN permission for "/mod/app3.bin" if it exists, delay set to 0
 - **AT#M2MRUN=0,"app2.bin",0**
NO RUN permission for "/mod /app2.bin", delay set to 0. The RUN permission of all other *.bin files are not changed
- Immediate load modes: <mode>=3, <mode>=4, <mode>=5
Immediate effects, the appcfg.ini file is not updated, RUN permission are not changed at next reboot.
- **AT#M2MRUN=3**
immediate unload of all apps in running
 - **AT#M2MRUN=3,"app2.bin"**
immediate unload of app2.bin, if in running
- AT#M2MRUN=3,"app2.bin",10** set also delay to 10 for app2.bin application
- **AT#M2MRUN=4**
immediate load of all apps if not already in running. The current delays are considered
 - **AT#M2MRUN=4,,20**
Immediate load of all apps if not already in running. The delay of 20 seconds is applied for all apps
 - **AT#M2MRUN=4,"app2.bin"**
immediate load of app2.bin if not already in running. The delay is considered
 - **AT#M2MRUN=4,"app2.bin",10**
immediate load of app2.bin if not already in running. The delay of 10 seconds is applied to app2.bin app
 - **AT#M2MRUN=5,"app2.bin"**
immediate unload of all apps in running, and immediate load of app2.bin with current delay, if not already in running.
 - **AT#M2MRUN=5,"app2.bin",0**
immediate unload of all apps in running, and immediate load of app2.bin with no delay, if not already in running
-

**AT#M2MRUN?**

Read command reports the files with the RUN file permission. The files are stored in the directory /mod. The report has the following format

#M2MRUN: <"app1.bin",delay1> <"app2,bin", delay2> ...

**AT#M2MRUN=?**

Test command returns the allowed values for parameters <mode> and <delay>. The format is:

#M2MRUN: (0-5)(...)(1-60)

3.23.5. AT+M2M - Enable/disable M2M Application execution

This command enable/disable the M2M Application execution start mode.

SIM Presence	Setting saved	Can be aborted	MAX timeout	SELINT
Not required	Auto	No	-	2



AT+M2M=<mode>[,<delay>]

Set command sets the M2M Application start mode. After issuing the AT command, the module automatically restart.

Parameters:

Name	Type	Default	Description
<mode>	integer	0	M2M application execution start mode
Values:			
0	:	AppZone engine does not start at the next reboot	
1	:	AppZone engine starts at the next reboot without delay. Only apps with AT#M2MRUN=1 will start after reboot, with their specific delay setting.	
4	:	AppZone engine starts at the next reboot using the delay set by <delay> parameter, if missing is used the default value 10.	
<delay>	integer	10	M2M application execution start time-out expressed in seconds. Parameter <delay> is used only if parameter <mode> is set to 4.
Value:			
1÷60	:	It is the delay for AppZone engine to start. During this waiting time an AT command on the serial/USB port can disable the AppZone engine, and it will not start until the next reboot.	



AT+M2M?

Read command reports the M2M application execution start mode, start time-out and start shell in the format:

+M2M:<mode>,<delay>



AT+M2M=?

Test command returns the range of available values for parameters <mode> and <delay>.

3.23.6. AT#M2MWRITE - Write a File

This command stores a file in the file system.

SIM Presence	Setting saved	Can be aborted	MAX timeout	SELINT
Not required	No	No	-	2



AT#M2MWRITE=<full_path_file_name>,<size>

Execution command stores a generic file in the folder specified by <full_path_file_name> parameter. The file should be sent using RAW ASCII file transfer, and hardware flow control should be used. After command line is terminated with <CR>, the module prompts the following five-character sequence:

<CR>,<LF>,<greater_than><greater_than><greater_than> (see IRA 13, 10, 62, 62, 62)

then a file sized <size> bytes can be entered from TE.

The operations complete when all bytes are received. If writing ends successfully the response is **OK**, otherwise, an error code is reported.

Parameters:

Name	Type	Default	Description
<full_path_file_name>	string	-	path and file name should be passed between quotes. A maximum of 1024 chars for path not including a trailing '\\0' and a maximum of 768 chars for file name or single directory name, are allowed. <full_path_file_name> is case sensitive, as general practice, where possible, it is suggested to use lower length than the maximum allowed.
<size>	integer	-	file size



AT#M2MWRITE=?

Test commands returns **OK** result code.



Store "M2MAPZ.bin" file in "/mod" folder.

AT#M2MWRITE="/mod/M2MAPZ.bin",58044

>>> here receive the prompt; then type or send the file, sized 58044 bytes

OK

3.23.7. AT#M2MDEL - Delete File

This command deletes specified file stored in the File System.

SIM Presence	Setting saved	Can be aborted	MAX timeout	SELINT
Not required	No	No	-	2



AT#M2MDEL=<full_path_file_name>

Set command removes the <full_path_file_name> in the file system.

Parameter:

Name	Type	Default	Description
<full_path_file_name>	string	-	<p>path and file name should be passed between quotes. A maximum of 1024 chars for path not including a trailing '\0' and a maximum of 768 chars for file name or single directory name, are allowed.</p> <p><full_path_file_name> is case sensitive, as general practice, where possible, it is suggested to use lower length than the maximum allowed.</p>



If the file <full_path_file_name> is not present an error code is reported.



AT#M2MDEL?

Test command returns **OK** result code.



Remove M2MAPZ.bin file in "/mod" folder

```
AT#M2MDEL="/mod/M2MAPZ.bin"
OK
```

3.23.8. AT#M2MLIST - File System List

This command lists the contents of a folder in the File System.

SIM Presence	Setting saved	Can be aborted	MAX timeout	SELINT
Not required	No	No	-	2



AT#M2MLIST

Execution command reports the list of directories and files stored in "/core" directory of the file system. The report is in the format:

```
[<CR><LF>#M2MLIST: <.>
<CR><LF>#M2MLIST: <..>]
[<CR><LF>#M2MLIST: <dir_name_1>...
<CR><LF>#M2MLIST: <dir_name_n>]]
[<CR><LF>#M2MLIST: <file_name_1>,<size_1>...
<CR><LF>#M2MLIST: <file_name_n>,<size_n>]]
```

Additional info:

▶▶ Response parameters

Name	Type	Default	Description
<.>	string	-	current directory
<..>	string	-	upper directory
<dir_name>	string	-	directory name, string type delimited by characters '<' and '>' (max 768 characters, case sensitive).
<file_name>	string	-	file name, quoted sting type (max 768 characters, case sensitive).
<size>	integer	-	size of file in bytes



AT#M2MLIST=?

Test command returns **OK** result code.



```
AT#M2MLIST
#M2MLIST: <.>
#M2MLIST: <..>
#M2MLIST: <dir1>
#M2MLIST: "file_load.bin",58044
```

3.23.9. AT#M2MREAD - Read File

This command reports the content of a file stored in the File System.

SIM Presence	Setting saved	Can be aborted	MAX timeout	SELINT
Not required	No	No	-	2



AT#M2MREAD=<full_path_file_name>

Execution command reads the content of a generic file stored in the folder specified by <full_path_file_name> parameter. After command line is terminated with <CR>, the module prompts the following five-character sequence:

<CR><LF><less_than><less_than><less_than> (see IRA 13, 10, 60, 60, 60)

followed by the file content.

Parameter:

Name	Type	Default	Description
<full_path_file_name>	string	-	path and file name should be passed between quotes. A maximum of 1024 chars for path not including a trailing '\0' and a maximum of 768 chars for file name or single directory name, are allowed. <full_path_file_name> is case sensitive, as general practice, where possible, it is suggested to use lower length than the maximum allowed.



If the file <full_path_file_name> is not present in the file system, an error code is reported.



AT#M2MREAD=?

Test command returns **OK** result code.



AT#M2MREAD="xxfolder/config/config.txt"

<<< here receive the prompt; then the file is displayed, immediately after the prompt
OK

3.24. GNSS

3.24.1. GNSS Configuration

3.24.1.1. AT\$LCSSLP - Update SLP Address

Update the SLP address.

SIM Presence	Setting saved	Can be aborted	MAX timeout	SELINT
Not required	Auto	No	-	2





AT\$LCSSLP=<slpAddressType>[,<slpAddress>[,<slpPortNumber>]]

Set command allows to update the SLP address and SLP port number.

Parameters:

Name	Type	Default	Description
<slpAddressType>	integer	1	SLP address type
Values:			
	0	:	IPv4
	1	:	FQDN
	2	:	Delete SLP address
	3	:	IPv6
<slpAddress>	string	-	SLP address in FQDN format or IPv4 format
<slpPortNumber>	integer	-	SLP port number. Default value is 0.

-  If **<slpAddressType>** is 0, 1 or 3, then **<slpAddress>** is a mandatory parameter.
-  Other types of address are erased during set command.



AT\$LCSSLP?

Read command returns the current SLP parameters, in the format:

\$LCSSLP: <slpAddressType>,<slpAddress>,<slpPortNumber>



AT\$LCSSLP=?

Test command returns the supported values of parameter **<slpAddressType>**.

3.24.1.2. AT\$LCSTER - Update Terminal Information

This command updates the terminal information like IMSI, MSISDN or IPv4 address.

SIM Presence	Setting saved	Can be aborted	MAX timeout	SELINT
Not required	No	No	-	2



AT\$LCSTER=<idType>[,<idValue>[,<prefPosMode>[,<tlsMode>]]]

Set command updates the terminal information like IMSI, MSISDN or IPv4 address.

Parameters:

Name	Type	Default	Description
<idType>	integer	1	a number which can have any of the following values
	Values:		
	0	:	MSISDN
	1	:	IMSI
	2	:	IPv4 address
	3	:	invalid
<idValue>	string	-	a string, as defined in <idType>
<prefPosMode>	integer	0	preferred position mode
	Values:		
	0	:	default position mode
	1	:	none preferred position mode
<tlsMode>	integer	1	indicates if TLS mode should/should not be used by the SET
	Values:		
	0	:	non-TLS mode
	1	:	TLS mode

i If **<idType>** is MSISDN or IPv4 address then **<idValue>** shall be entered.

3.24.1.3. AT\$LICLS - Enable/Disable Unsolicited Response

This command enables the **\$LICLS**: unsolicited response.

SIM Presence	Setting saved	Can be aborted	MAX timeout	SELINT
Not required	Auto	No	-	2



AT\$LICLS=<mode>

Set command enables/disables the unsolicited **\$LICLS**: response. The unsolicited result code is in the format:

\$LICLS: <requestType>[,<cid>]

Parameter:

Name	Type	Default	Description
<mode>	integer	1	unsolicited response mode

Values:

- 0 : disable unsolicited
- 1 : enable unsolicited

Unsolicited fields:

Name	Type	Description
<requestType>	integer	<p>If the <requestType> is a setup request, the unsolicited indication is sent/used to request the client to define, setup, activate and prepare the PDP context.</p> <p>If <requestType> is a release request, the unsolicited indication is sent/used to inform the client that the PDP context (associated with this command type) including the associated terminal is not used any more, and shall be deactivated.</p> <p>Values:</p> <ul style="list-style-type: none"> 0 : Setup Request to setup the control link 1 : Release Request to release the control link
<cid>	integer	Id associated to the context that shall be deactivated (see +CGDCONT)



AT\$LICLS?

Read command returns the current value of parameter <mode>.



AT\$LICLS=?

Test command returns the range of values for parameter <mode>.

3.24.1.4. AT\$LTC - LCS Certificate

This command is used to pass the security objects (e.g. certificate, key) to the Transport Layer Security Protocol, via binary string.

SIM Presence	Setting saved	Can be aborted	MAX timeout	SELINT
Not required	Auto	No	-	2



AT\$LTC=<string>,<totalMessageLength>,<seqNo>,<securityObjectType>

Set command is used to pass the security objects (e.g. certificate, key) to the Transport Layer Security Protocol (binary string). The certificate shall be in hexadecimal format (each octet of the certificate is given as two IRA character long hexadecimal number).

Parameters:

Name	Type	Default	Description
<string>	string	-	string certificate segment. The maximum value of accepted characters is 300 characters per segment.
<totalMessageLength>	integer	N/A	total certificate size to be received Value: 1÷4096 : overall number of Certificate characters
<seqNo>	integer	N/A	sequence number of the segment Value: 1÷13 : sequence number
<securityObjectType>	integer	0	security object typology. Only value 0 is accepted. Value: 0 : Root Certificate

 Execution command deletes the certificates stored in NVM.



AT\$LTC?

Read command provides the first 300 characters of each valid certificate stored in NVM in the format:

\$LTC: <string>,<totalMessageLength>,1, <securityObjectType>

If no certificate is stored, the read command provides:

\$LTC: "",0,1 ,<securityObjectType>



AT\$LTC=?

Test command returns the range of values for parameters <totalMessageLength>,<seqNo> and <securityObjectType>.

3.24.1.5. AT\$LCSLK - Lock Context for LCS Use

The command is used to reserve or release a cid for LCS Location Services

SIM Presence	Setting saved	Can be aborted	MAX timeout	SELINT
Not required	Auto	No	-	2





AT\$LCSLK=<mode>[,<cid>]

Set command is used to reserve a specified cid or release the current cid for LCS Location Services.

Parameters:

Name	Type	Default	Description
<mode>	integer	N/A	Lock a specified cid / Unlock the current cid
Values:			
0	:		unlock the current cid available for LCS use
1	:		lock the specified cid in order to setup/release a control link for LCS use only
<cid>	integer	-	specifies a PDP context definition (see +CGDCONT command).

-  <cid> is mandatory if <mode> is set to lock, otherwise shall be omitted
-  the set command returns **ERROR** if the current cid and/or the previously set are in use



AT\$LCSLK?

Read command returns the current value of parameters <mode> and <cid> (if <mode> is lock).



AT\$LCSLK=?

Test command returns the range of values for parameters <mode> and <cid>.

3.24.1.6. AT\$GPSQOS - GPS Quality of Service

Command used to set the location's quality of service (QoS)

SIM Presence	Setting saved	Can be aborted	MAX timeout	SELINT
Not required	Other	No	-	2

AT\$GPSQOS=[<horizAccu>,<verticAccu>,<rspTime>,<ageLocInfo>,<locationType>,<navProfile>,<velRequest>]]]]]]]]

Command used to set the location's quality of service (QoS).

Parameters:

Name	Type	Default	Description
<horizAccu>	integer	1800000	horizontal accuracy
Value:			
0÷1800000 : 0 is highest accuracy, 1800000 is lowest accuracy (in meters)			
<verticAccu>	integer	990	vertical accuracy
Value:			
0÷990 : 0 is highest accuracy, 990 is lowest accuracy (in meters)			
<rspTime>	integer	14400	response time
Value:			
0÷14400 : 0 is the low delay and 14400 is the highest delay in seconds			
<ageLocInfo>	integer	0	maximum age of location
Value:			
0÷1966020 : 0 means that stored location information should not be used. Value 1966020 indicates the maximum tolerable age of the stored location information. The valid range of interval for SUPL (Transport protocol) is [0 - 65535] seconds & [0 - 1966020] seconds for C-plane (Transport protocol).			
<locationType>	integer	0	type of location required. Used only in case of C-Plane
Values:			
0 : Current Location			
1 : Current or Last known location			
2 : Invalid Location, indicates that this parameter shall not be used			
<navProfile>	integer	0	navigation profile
Values:			
0 : Car navigation profile			
1 : Personal profile			

	2	:	Low speed profile
	3	:	Invalid profile, indicates that this parameter shall not be used

<velRequest>	integer	1	velocity information is needed
---------------------------	---------	---	--------------------------------

Values:

0	:	FALSE
1	:	TRUE

**AT\$GPSQOS?**

Read command returns the current QoS values, in the format:

AT\$GPSQOS:<horizAccu>,<verticAccu>,<rspTime>,<ageLocInfo>,<locationType>,<navProfile>,<velRequest>

**AT\$GPSQOS=?**

Returns the list of supported QoS values for each field.



The current setting is stored through **\$GPSSAV**.



AT\$GPSQOS=1800000,990,150,0,0,0
OK

3.24.1.7. AT\$GPSSTOP - Stop Location Service Request

Command used to stop location service request.

SIM Presence	Setting saved	Can be aborted	MAX timeout	SELINT
Not required	Other	No	-	2



AT\$GPSSTOP=[<abort_cause>]

Command used to stop the Receiver in Autonomous or A-GPS mode initiated through \$GPSSLSR set command.

Parameter:

Name	Type	Default	Description
<abort_cause>	integer	1	Set abort cause.

Values:

- 0 : User denies the request
- 1 : Unspecified cause for abort
- 2 : Cause Invalid



The default factory value is 1, it can be recovered by \$GPSRST.



AT\$GPSSTOP?

Read command returns the current value of parameter <abort_cause>.



AT\$GPSSTOP=?

Test command returns **OK** result code.



The current setting is stored through \$GPSSAV.

3.24.1.8. AT\$GPSSLSR - Start Location Service Request

Command used to start the Receiver in Autonomous or A-GPS mode.

SIM Presence	Setting saved	Can be aborted	MAX timeout	SELINT
Not required	Other	No	-	2



AT\$GPSSLSR=<transport_protocol>[,<pos_mode>[,<client_id>,<clientid_type>[,<mlc_number>,<mlcnumber_type>[,<interval>[,<service_type_id>[,<pseudonym_indicator>],<error_mask>]]]]]]]

Execution command configures location service request.

Parameters:

Name	Type	Default	Description
<transport_protocol>	integer	N/A	Configure transport protocol. If <pos_mode> is Autonomous the <transport_protocol> should be invalid. If <transport_protocol> is C-plane and <pos_mode> is Pure MS Assisted, then <interval> should be 0 (or omitted).
<pos_mode>	integer	N/A	Configure MS Based mode. If <pos_mode> is Autonomous the <transport_protocol> should be invalid.
<client_id>	string	-	String parameter containing the ID of the LCS-Client to which the location estimate is to be transferred. Max length is 64 bytes. <client_id> is mandatory in case of A-GPS and the <transport_protocol> should be C-plane.
<clientid_type>	integer	1	Configure client ID type.

			<client_id> and <clientid_type> are mandatory for A-GPS mode.
	Values:		
	0	:	MSISDN
	1	:	Invalid
<mlc_number>	string	-	String parameter containing the address of the GMLC through which the location estimate is to be sent to the LCS-Client. <mlc_number> is mandatory in case of A-GPS.
<mlcnumber_type>	integer	1	Configure mlc type. <mlc_number> and <mlcnumber_type> are mandatory for A-GPS mode.
	Values:		
	0	:	MSISDN
	1	:	Invalid
<interval>	integer	0	Configure interval period. If this value is not set, it is assumed to be 0. The Unsolicited NMEA sentences have to be enabled with the commands \$GPSNMUN .
	Value:		
	0÷7200	:	GPS reporting period in seconds (will be sent unsolicited). if the value is 0 then a single shot NMEA Message will be provided Any value different from 0 sets the period (in seconds) between each NMEA Sentence
<service_type_id>	integer	N/A	Configure service type id. <service_type_id> is mandatory in case of A-GPS.
	Value:		
	0÷255	:	where 255 indicates that this parameter shall not be used
<pseudonym_indicator>	integer	0	Enable/disable display user name.
	Values:		
	0	:	display user name at the external client
	1	:	display user name as anonymous at the external client
<error_mask>	string	-	if certain bit is set, respective error code becomes non-abortable. If this value is not set, it is assumed to be 0.

Additional info:

- ▶▶ If C-plane or Supl session is not successfully completed, then an unsolicited indication reports the error cause in the following formats:

\$GPSSLSR: SUPL/C-PLANE ERROR, <error_code>

<error_code>	
0	Phone Offline
1	No service
2	No connection with PDE
3	No data available
4	Session Manager Busy
5	Phone is CDMA locked
6	Phone is GPS locked
7	Connection failure with PDE
8	PDSM Ended session because of Error condition
9	User ended the session
10	End key pressed from UI
11	Network Session was ended
12	Timeout (viz., for GPS Search)
13	Conflicting request for session and level of privacy
14	Could not connect to the Network
15	Error in Fix
16	Reject from PDE
17	Ending session due to TC exit
18	Ending session due to E911 call
19	Added protocol specific error type
20	Ending because BS info is stale
21	VX Ics agent auth fail
22	Unknown System Error
23	Unsupported Service
24	Subscription Violation
25	The desired fix method failed
26	Antenna switch
27	No fix reported due to no tx confirmation rcvd
28	Network indicated a Normal ending of the session
29	No error specified by the network
30	No resources left on the network
31	Position server not available
32	Network reported an unsupported version of protocol
33	MOLR System failure
34	MOLR Unexpected data value
35	MOLR Data missing
36	MOLR Facility Not Supported
37	MOLR Subscription Violation
38	MOLR Position Method Failure
39	MOLR Undefined

Errors [1-32] can be marked as non – abortable, using <error_mask>, so session will continue until stopped manually by user.
 EXCEPTIONS: Errors [9-12] are non – abortable by default, and <error_mask> does not affect them.

**AT\$GPSSLSR?**

Read command returns the current settings, in the format:

```
$GPSSLSR: <transport_protocol>[,<pos_mode >[,<client_id>,<clientid_type>
[,<mlc_number>,<mlcnumber_type>[,< interval>[,<service_type_id>
[,<pseudonym_indicator>][,<error_mask>]]]]]]
```

**AT\$GPSSLSR=?**

Returns the list of supported SLSR values for each field.

```
$GPSSLSR: (0-2),(0-3),(64),(0,1),(64),(0,1),(0-7200),(0-255),(0,1) ,(0-4294967295)
```



The current setting is stored through **\$GPSSAV**.



Power up clears GPS memory and then starts the GPS receiver. GPS data cleaning is performed on the base of the current value of the **<reset_type>** parameter (see **\$GPSR**)



```
AT$GPSSLSR= 2,3,,,,,1
OK
```

3.24.1.9. AT\$SUPLV - Set the Version of the Supported SUPL

This command configures the version of supported SUPL.

SIM Presence	Setting saved	Can be aborted	MAX timeout	SELINT
Not required	Auto	No	-	2



AT\$SUPLV=<version>

Set command configures the version of supported SUPL.

Parameter:

Name	Type	Default	Description
<version>	integer	0	set the SUPL version.

Values:

- 0 : N/S SUPL
- 1 : SUPL 1.0
- 2 : SUPL 2.0



AT\$SUPLV?

Read command returns the SUPL version, in the format:

\$SUPLV: x.y

Where "x.y" is the string corresponding to currently set version, or "0.0" if version has not been set yet.



AT\$SUPLV=?

Test command returns the supported range of values of parameters < version>:

\$SUPLV: (0-2)



```
AT$SUPLV =1
OK
```

```
AT$SUPLV?
$SUPLV:1.0
OK
```

3.24.1.10. AT\$SLP - Update SLP Address

This command allows updating the SLP parameters.

SIM Presence	Setting saved	Can be aborted	MAX timeout	SELINT
Not required	Auto	No	-	2



AT\$SLP=[<slp_address_type>,<slp_address>,<slp_port_number>]]

Set command allows updating the SLP address and SLP port number.

Parameters:

Name	Type	Default	Description
<slp_address_type>	integer	0	SLP address type
Values:			
	0	:	IPv4
	1	:	FQDN
	3	:	IPv6
<slp_address>	string	-	SLP address in FQDN format, IPv4 or IPv6 format.
<slp_port_number>	integer	-	SLP port number. Default value is 7275.



If <slp_address> is omitted, chosen <slp_address_type> will be deleted.



AT\$SLP?

Read command returns the current SLP address <slp_address> and, if address is not empty, the <slp_port_number> port number, in the format:

\$SLP: <slp_address>,<slp_port_number>



AT\$SLP=?

Test command returns the range of values in the following format:

\$SLP: (0,1,3)



IPv6 is passed in the following format:
AT\$SLP=3,"[2001:db8:255::8:7]:7275"

3.24.1.11. AT\$SLPTYPE - Update SLP Type Address

This command allows updating the SLP address type to be chosen.

SIM Presence	Setting saved	Can be aborted	MAX timeout	SELINT
Not required	Auto	No	-	2



AT\$SLPTYPE=[<slp_address_type>]

Set command allows updating the SLP address type to be chosen.

Parameter:

Name	Type	Default	Description
<slp_address_type>	integer	0	SLP address type. This parameter also update during \$SLP set command.

Values:

- 0 : IPv4
- 1 : FQDN
- 3 : IPv6



AT\$SLPTYPE?

Read command returns the current SLP address type.



AT\$SLPTYPE=?

Test command returns the range of values in the following format:

\$SLPTYPE: (0-1, 3)

3.24.1.12. AT\$SUPLCFG - Configure SUPL TLS and Hash

This command permits to configure the SUPL TLS and Hash algorithm version.

SIM Presence	Setting saved	Can be aborted	MAX timeout	SELINT
Not required	Auto	No	-	2



AT\$SUPLCFG[<tls>],[<hash>]

Set command configures the SUPL TLS and Hash algorithm version.

Parameters:

Name	Type	Default	Description
<tls>	integer	1	selects TLS version.
Values:			
0	:	use TLS v.1.0	
1	:	use TLS v.1.1	
<hash>	integer	1	selects SHA version.
Values:			
0	:	use SHA-1	
1	:	use SHA-256	



AT\$SUPLCFG?

Read command reports the currently selected <tls> and <hash> in the format:

\$SUPLCFG: <tls>,<hash>



AT\$SUPLCFG=?

Test command reports the supported range of values for parameters: <tls> and <hash>.

3.24.1.13. AT\$LCSLUI - Update Location Information

Set command allows updating the Location information.

SIM Presence	Setting saved	Can be aborted	MAX timeout	SELINT
Not required	Auto	No	-	2



AT\$LCSLUI=[<update_type>]

Parameter:

Name	Type	Default	Description
<update_type>	integer	0	Current access technology

Values:

- 0 : GSM
- 1 : dummy value



The current access technology can be read with **+COPS?**



AT\$LCSLUI=?

Test command returns the range of values for parameter.

3.24.1.14. AT\$SUPLSEC - Set the User Plane Secure Transport

This command configures the User Plane Secure Transport

SIM Presence	Setting saved	Can be aborted	MAX timeout	SELINT
Not required	Auto	No	-	2



AT\$SUPLSEC=[<option>]

Set command configures the User Plane Secure Transport

Parameter:

Name	Type	Default	Description
<option>	integer	0	enables/disables User Plane Secure Transport.

Values:

- 0 : disable
- 1 : enable



AT\$SUPLSEC?

Read command returns the currently used values, in the format:

\$SUPLSEC: < option >



AT\$SUPLSEC=?

Test command returns the supported range of values of parameters < option >:

\$SUPLSEC: (0-1)



```
AT$SUPLSEC =1
OK
```

```
AT$SUPLSEC?
$SUPLSEC:1
OK
```

3.24.2. GNSS Receiver

3.24.2.1. AT\$GPSAT - GNSS Antenna LNA Control

This command selects the GNSS antenna.

SIM Presence	Setting saved	Can be aborted	MAX timeout	SELINT
Not required	Other	No	-	2



AT\$GPSAT=<type>

Set command selects the GNSS antenna. It is maintained for backward compatibility

Parameter:

Name	Type	Default	Description
<type>	integer	1	Antenna type

Values:

- 0 : GPS Antenna not power supplied by the module
- 1 : GPS Antenna power supplied by the module



AT\$GPSAT?

Read command returns the current value of <type> in the format:

\$GPSAT: <type>



AT\$GPSAT=?

Test command reports the range of supported values for parameter <type>.



The current setting is stored through **AT\$GPSSAV**.



```
AT$GPSAT=1
OK
```

3.24.2.2. AT\$GPSSAV - Save GPS Parameters Configuration

This command stores the current GNSS parameters in the NVM of the cellular module

SIM Presence	Setting saved	Can be aborted	MAX timeout	SELINT
Not required	No	No	-	2



AT\$GPSSAV

Execution command stores the current GNSS parameters in the NVM of the cellular module



AT\$GPSSAV=?

Test command returns the **OK** result code



The module must be restarted to use the new configuration

3.24.2.3. AT\$GPSRST - Restore Default GPS Parameters

This command resets the GNSS parameters to "Factory Default" configuration

SIM Presence	Setting saved	Can be aborted	MAX timeout	SELINT
Not required	Auto	No	-	2



AT\$GPSRST

Set command resets the GNSS parameters to "Factory Default" configuration and stores them in the NVM of the cellular modules



AT\$GPSRST=?

Test command returns the **OK** result code



The module must be restarted to use the new configuration

3.24.2.4. AT\$GPSP - GNSS Controller Power Management

This command powers on/off GNSS controller .

SIM Presence	Setting saved	Can be aborted	MAX timeout	SELINT
Not required	Other	No	-	2



AT\$GPSP=<status>



The set command manages the power-up/power-down of the GNSS controller.

Parameter:

Name	Type	Default	Description
<status>	string	0	indicates the power status that has to be set.

Values:

- 0 : GNSS controller is powered down
- 1 : GNSS controller is powered up

-  Power up clears GPS memory and then starts the GPS receiver. GPS data cleaning is performed on the base of the current value of the <reset_type> parameter (see \$GPSR).
-  GPS operation mode is performed on the base of the current values of \$GPSSLSR configuration (see \$GPSSLSR).



AT\$GPSP?

The read command reports the current value of the <status> parameter, in the format:

\$GPSP: <status>



AT\$GPSP=?

The test command reports the supported values range for parameter <status>.



<status> value is stored through \$GPSSAV command.



```
GNSS controller is powered down
AT$GPSP=0
OK
```

3.24.3. GNSS General Management

3.24.3.1. AT\$GPSSW - GNSS Software Version

This command provides the GNSS module software version.

SIM Presence	Setting saved	Can be aborted	MAX timeout	SELINT
Not required	No	No	-	2



AT\$GPSSW

Execution command returns the GNSS module software version in the format:

\$GPSSW: <swVersion>



AT\$GPSSW?

Read command has the same behavior as the execution command.



AT\$GPSSW=?

Test command returns the **OK** result code

3.24.3.2. AT\$GPSCLR - Clear GPS Data

This command resets GPS data.

SIM Presence	Setting saved	Can be aborted	MAX timeout	SELINT
Not required	No	No	-	2



AT\$GPSCLR

This command resets all GPS data listed below:

- GPS Almanac Data
- GPS Ephemeris Data
- LBS User Plane PDE IP Address
- LBS User Plane PDE IP Port

 This command is global and cannot clear individual pieces of data.



AT\$GPSCLR=?

Test command returns the **OK** result code.



```
AT$GPSCLR=?
OK
```

```
AT$GPSCLR
OK
```

3.24.3.3. AT\$GPSR - Reset the GPS Controller

This command resets the GNSS controller.

SIM Presence	Setting saved	Can be aborted	MAX timeout	SELINT
Not required	Other	No	-	2



AT\$GPSR=<resetType>



Execution command allows to reset the GNSS controller.

Parameter:

Name	Type	Default	Description
<resetType>	integer	3	set the type of GNSS controller reset.

Values:

- 0 : Factory Reset: this option clears all the GNSS memory including Clock Drift.
- 1 : Coldstart (No Almanac, No Ephemeris): this option clears all data that is currently stored in the internal memory of the GNSS receiver including Position, Almanac, Ephemeris and Time. The stored Clock Drift is retained.
- 2 : Warmstart (No ephemeris): this option clears all initialization data in the GNSS receiver and subsequently reloads the data that is currently displayed in the Receiver Initialization Setup screen. The Almanac is retained but the Ephemeris is cleared.
- 3 : Hotstart (with stored Almanac and Ephemeris): the GNSS receiver restarts by using all data that is currently stored in the internal memory of the GNSS receiver: validated Ephemeris and Almanac.

-  **Factory Reset** performs the same operation as **Coldstart**.
-  <reset_type> sets the kind of start when GNSS is activated through **\$GPSP** or **\$GPSSLR** commands.



AT\$GPSR=?

Test command reports the range of supported values for parameter <resetType>.



The current setting is stored through **\$GPSSAV** command.



Factory reset
AT\$GPSR=0
OK

3.24.3.4. AT\$GPSAV - GPS Antenna Supply Voltage Readout

This command returns the measured GPS antenna's supply voltage.

SIM Presence	Setting saved	Can be aborted	MAX timeout	SELINT
Not required	No	No	-	2



AT\$GPSAV

Execution command returns the measured GPS antenna's supply voltage in mV.



AT\$GPSAV?

Read command has the same meaning as the execution command.



AT\$GPSAV=?

Test command returns the **OK** result code

3.24.3.5. AT\$GPSGLO - Set the GNSS (or GLONASS) Capability

This command selects the GNSS capability used.

SIM Presence	Setting saved	Can be aborted	MAX timeout	SELINT
Not required	Auto	No	-	2



AT\$GPSGLO=[<type>]

Set command selects the GNSS (or GLONASS) capability used.

Parameter:

Name	Type	Default	Description
<type>	string	1	enables/disables GNSS (or GLONASS) capability.

Values:

- 0 : Disable GNSS (or GLONASS)
- 1 : Enable GNSS (or GLONASS)

 This command is saved in NVM and has effect only at the next power cycle.



AT\$GPSGLO?

Read command returns the currently used GNSS (or GLONASS), in the format:

\$GPSGLO: <type>



AT\$GPSGLO=?

Test command reports the range of supported values for parameter <type>



```
AT$GPSGLO=1
OK
```

3.24.4. GNSS Positioning Information

3.24.4.1. AT\$GPSNMUN - Unsolicited NMEA Data Configuration

Unsolicited NMEA Data Configuration



[1] NMEA 0183 Standard

SIM Presence	Setting saved	Can be aborted	MAX timeout	SELINT
Not required	Specific profile	No	-	2



AT\$GPSNMUN=<enable>[,<GGA>,<GLL>,<GSA>,<GSV>,<RMC>,<VTG>]

Set command allows to activate an unsolicited GNSS data stream built with NMEA sentences on the standard serial port and defines which NMEA sentences will be available.

Refer to document [1] to have information on the NMEA sentences contents and formats.

Parameters:

Name	Type	Default	Description
<enable>	integer	0	Enables unsolicited GNSS data stream and selects one of the available GNSS data stream format display. <enable> parameter is also used to disable the GNSS data stream. Here is the list of the <enable> values. See Additional info section to have information on GNSS data stream formats.
Values:			
0	:	disable GNSS data stream	
1	:	enable the first GNSS data stream format	
2	:	enable the second GNSS data stream format	
3	:	enable the first GNSS data stream format, and reserve the AT interface port only for the GNSS data stream	
<GGA>	integer	0	enables/disables the presence of the Global Positioning System Fix Data NMEA sentence (GGA) in the GNSS data stream.
Values:			
0	:	disable	
1	:	enable	
<GLL>	integer	0	enable/disable the presence of the Geographic Position - Latitude/Longitude NMEA sentence (GLL) in the GNSS data stream.
Values:			
0	:	disable	
1	:	enable	
<GSA>	integer	0	enable/disable the presence of the GNSS DOP and Active Satellites NMEA sentence (GSA) in the GNSS data stream.
Values:			

	0	:	disable
	1	:	enable
<GSV>	integer	0	enable/disable the presence of the Satellites in View NMEA sentence (GSV) in the GNSS data stream.
	Values:		
	0	:	disable
	1	:	enable
<RMC>	integer	0	enable/disable the presence of the Recommended Minimum Specific GNSS Data NMEA sentence (RMC) in the GNSS data stream.
	Values:		
	0	:	disable
	1	:	enable
<VTG>	integer	0	enable/disable the presence of the GNSS Course Over Ground and Ground Speed NMEA sentence (VTG) in the GNSS data stream.
	Values:		
	0	:	disable
	1	:	enable

Additional info:

- ▶▶ **<enable>=1**, GNSS data stream format:
\$GPRMUN: <NMEA SENTENCE 1><CR><LF>
 ...
\$GPRMUN: <NMEA SENTENCE N><CR><LF>
 ...
- ▶▶ **<enable>=2**, GNSS data stream format:
<NMEA SENTENCE 1><CR><LF>
 ...
<NMEA SENTENCE N><CR><LF>
 ...
- ▶▶ **<enable>=3**, in this case, the AT interface port is dedicated to NMEA sentences, it is not possible to send AT commands. Use the escape sequence "+++" to return in command mode. GNSS data stream format:
\$GPRMUN: <NMEA SENTENCE 1><CR><LF>
 ...
\$GPRMUN: <NMEA SENTENCE N><CR><LF>
 ...
 The NMEA data stream format is the same as the one selected by **<enable>=1**.

**AT\$GPSNMUN?**

Read command returns whether the unsolicited GNSS data stream is currently enabled or not, along with the current NMEA mask configuration, in the format:

\$GPSNMUN:<enable>,<GGA>,<GLL>,<GSA>,<GSV>,<RMC>,<VTG >

**AT\$GPSNMUN=?**

Test command returns the supported range of values for parameters:

<enable> , <GGA> , <GLL> , <GSA> , <GSV> , <RMC> , <VTG>.



Set the GSA as available sentence in the unsolicited message

AT\$GPSNMUN=1,0,0,1,0,0,0
OK

Turn-off the unsolicited mode

AT\$GPSNMUN=0
OK

Read the current NMEA mask configuration:

AT\$GPSNMUN?
\$GPSNMUN: 1,0,0,1,0,0,0
OK

The unsolicited message will be:

\$GPGSA,A,3,23,20,24,07,13,04,02,,,,,2.4,1.6,1.8*3C

3.24.4.2. AT\$GPSACP - Get Acquired Position

This command returns information about the last GPS position.



[1] NMEA 0183 Standard

SIM Presence	Setting saved	Can be aborted	MAX timeout	SELINT
Not required	No	No	-	2



AT\$GPSACP

Execution command returns information about the last GPS position in the format:

\$GPSACP: <UTC>,<latitude>,<longitude>,<hdop>,<altitude>,<fix>,<cog>,<spkm>,<spkn>,<date>,<nsat>

Additional info:

- ▶▶ Meanings of the parameters returned by the command.

Name	Type	Default	Description
<UTC>	string	-	UTC time (hhmmss.sss) referred to GGA sentence
<latitude>	string	-	latitude in the format ddmm.mmmm N/S (referred to GGA sentence) where: dd: 00..90, degrees mm.mmmm: 00.0000..59.9999, minutes N/S: North/South
<longitude>	string	-	longitude in the format dddmm.mmmm E/W (referred to GGA sentence) where: ddd: 000..180, degrees mm.mmmm: 00.0000..59.9999, minutes E/W: East/West
<hdop>	string	-	Horizontal Dilution of Precision (referred to GGA sentence)
<altitude>	string	-	altitude - mean-sea-level (geoid) in meters (referred to GGA sentence)
<fix>	integer	N/A	fix type Values: 0 : invalid fix 1 : invalid fix 2 : 2D fix 3 : 3D fix
<cog>	string	-	Course over Ground (degrees, True) (referred to VTG sentence) in the format ddd.mm

			where: ddd: 000..360, degrees mm: 00..59, minutes
<spkm>	string	-	speed over ground (Km/hr) (referred to VTG sentence)
<spkn>	string	-	speed over ground (knots) (referred to VTG sentence)
<date>	string	-	date of fix (referred to RMC sentence) in the format ddmmyy where: dd: 01..31, day mm: 01..12, month yy: 00..99, year 2000 to 2099
<nsat>	integer	N/A	total number of satellites in use (referred to GGA sentence)
	Value:		
	0÷12	:	total number of satellites in use



AT\$GPSACP?

Read command has the same behavior as the Execution command.



AT\$GPSACP=?

Test command returns the **OK** result code.



AT\$GPSP?
\$GPSP: 0

when module is down there no acquired position

AT\$GPSACP
\$GPSACP: 000000.000,,,,,0,,,,000000,00
OK

AT\$GPSP=1
OK

Until first fix is received the command will display initial GPS position

AT\$GPSACP
\$GPSACP: 3124.6000N,03504.2000E,0.0,-18.0,0,0.0,0.0,0.0,060180,00

Once fix has been received the command will display actual GPS position

OK
AT\$GPSACP
\$GPSACP: 3206.4020N,03450.2678E,1.1,3.3,0,0.0,0.0,0.0,030613,06
OK

3.24.4.3. AT\$GPSNMUNEX - Unsolicited NMEA Extended Data Configuration

This command permits to activate an unsolicited streaming of GNSS (or GLONASS) data.

SIM Presence	Setting saved	Can be aborted	MAX timeout	SELINT
Not required	Auto	No	-	2



AT\$GPSNMUNEX=[<GNGNS>[,<GNGSA>[,<GLGSV>[,<GPGRS>[,<GAGSV>[,<GAGSA>[,<GAVTG>[,<GPGGA>[,<PQGSA>[,<PQGSV>]]]]]]]]]]]

Set command permits to activate an unsolicited streaming of GNSS (or GLONASS) data (in NMEA extended format) through the NMEA port and defines which NMEA extended sentences will be available.

Parameters:

Name	Type	Default	Description
<GNGNS>	integer	0	Fix data of GNSS (or GLONASS) receivers.
	Values:		
	0	: disable	
	1	: enable	
<GNGSA>	integer	0	DOP and active satellites of GNSS (or GLONASS).
	Values:		
	0	: disable	
	1	: enable	
<GLGSV>	integer	0	GLONASS satellites in view
	Values:		
	0	: disable	
	1	: enable	
<GPGRS>	string	0	GPS Range Residuals
	Values:		
	0	: disable	
	1	: enable	
<GAGSV>	integer	0	Galileo satellites in view
	Values:		
	0	: disable	
	1	: enable	
<GAGSA>	integer	0	Galileo DOP and active satellites
	Values:		
	0	: disable	
	1	: enable	
<GAVTG>	integer	0	Galileo track made good and ground speed

Values:

0 : disable
1 : enable

<GPGGA> integer 0 GPS fix data

Values:

0 : disable
1 : enable

<PQGSA> integer 0 Proprietary string for fix data regarding BeiDou and QZSS

Values:

0 : disable
1 : enable

<PQGSA> integer 0 Proprietary string for satellites in view regarding BeiDou and QZSS

Values:

0 : disable
1 : enable

 NMEA extended data is displayed on NMEA port depending on **\$GPSNMUN <enable>** parameter setting.



AT\$GPSNMUNEX?

Read command returns the NMEA extended sentences availability status, in the format:

\$GPSNMUNEX:<GNGNS>,<GNGSA>,<GLGSV>,<GPGRS>,<GAGSV>,<GAGSA>,<GAVTG>,<GPGGA>,<PQGSA>,<PQGSV>



AT\$GPSNMUNEX=?

Test command returns the supported range of values for parameters:

<GNGNS>,<GNGSA>,<GLGSV>,<GPGRS>,<GAGSV>,<GAGSA>,<GAVTG>,<GPGGA>,<PQGSA>,<PQGSV>



```
AT$GPSNMUN=1  
OK
```

```
AT$GPSNMUNEX=1,0,0,0,0,0,0,0,0  
OK
```

These sets the GNGNS as available sentence in the unsolicited NMEA sentences.

```
AT$GPSNMUNEX?  
$GPSNMUNEX: 1,0,0,0,0,0,0,0,0  
OK
```

Give the current frame selected (GNGNS)

The unsolicited message will be:

```
$GNGNS,080558.0,3731.306144,N,12655.784429,E,AN,09,1.0,68.0,18.0,,*5B
```

3.25. PSM (Power Saving Mode)

3.25.1. AT+CPSMS - Power Saving Mode Setting

This command enables/disables Power Saving Mode (PSM) mode.



[1] 3GPP TS 27 007
[2] 3GPP TS 24.008

SIM Presence	Setting saved	Can be aborted	MAX timeout	SELINT
Required	Auto	No	-	2





AT+CPSMS=[<mode>,<ReqPeriodicRAU>,<ReqGPRSreadyTimer>,<ReqPeriodicTAU>,<ReqActiveTime>]]]]]

The set command controls the setting of the UEs power saving mode (PSM) parameters. The command controls whether the UE wants to apply PSM or not, as well as the requested extended periodic RAU value and the requested GPRS READY timer value in GERAN, the requested extended periodic TAU value in E-UTRAN and the requested Active Time value.

Parameters:

Name	Type	Default	Description
<mode>	integer	0	disables or enables the use of PSM in the UE.
Values:			
	0	:	Disable
	1	:	Enable
<ReqPeriodicRAU>	string	-	one byte in an 8 bit format. Requested extended periodic RAU value (T3312) to be allocated to the UE in GERAN. The requested extended periodic RAU value is coded as one byte (octet 3) of the GPRS Timer 3 information element coded as bit format (e.g. "01000111" equals 70 hours). For the coding and the value range, see the GPRS Timer3 IE in 3GPP TS 24.008
<ReqGPRSreadyTimer>	string	-	one byte in an 8 bit format. Requested GPRS READY timer value (T3314) to be allocated to the UE in GERAN. The requested GPRS READY timer value is coded as one byte (octet 2) of the GPRS Timer information element coded as bit format (e.g. "01000011" equals 3 decihours or 18 minutes). For the coding and the value range, see the GPRS Timer IE in 3GPP TS 24.008.
<ReqPeriodicTAU>	string	-	one byte in an 8 bit format. Requested extended periodic TAU value (T3412) to be allocated to the UE in E-UTRAN. The requested extended periodic TAU value is coded as one byte (octet 3) of the GPRS Timer 3 information element coded as bit format (e.g. "01000111" equals 70 hours). For the coding

			and the value range, see the GPRS Timer 3 IE in 3GPP TS 24.008.
<ReqActiveTime>	string	-	one byte in an 8 bit format. Requested Active Time value (T3324) to be allocated to the UE. The requested Active Time value is coded as one byte (octet 3) of the GPRS Timer 2 information element coded as bit format (e.g. "00100100" equals 4 minutes). For the coding and the value range, see the GPRS Timer 2 IE in 3GPP TS 24.008.

-  A special form of the command can be given as **AT+CPSMS=** (with all parameters omitted). In this form, the parameter **<mode>** will be set to 0, the use of PSM will be disabled and data for all parameters in command **+CPSMS** will be removed or, if available, set to the manufacturer specific default values.
-  CPSMS configuration is saved in the file system

**AT+CPSMS?**

Read command returns the current CPSMS configuration, in the format:

+CPSMS:<mode>,[<ReqPeriodicRAU>],[<ReqGPRSreadyTimer>],[<ReqPeriodicTAU>],[<ReqActiveTime>]

**AT+CPSMS=?**

Test command reports the range for the parameters in the format:

+CPSMS:(list of supported <mode>s),(list of supported <ReqPeriodicRAU>s),(list of supported <ReqGPRSreadyTimer>s),(list of supported <ReqPeriodicTAU>s),(list of supported <ReqActiveTime>s)



How to manage timer values octet.

T3412ext value:

Bits 5 to 1 represent the binary coded timer value.

Bits 6 to 8 defines the timer value unit as follows:

Bits

8 7 6

0 0 0 value is incremented in multiples of 10 minutes

0 0 1 value is incremented in multiples of 1 hour

0 1 0 value is incremented in multiples of 10 hours

0 1 1 value is incremented in multiples of 2 seconds

1 0 0 value is incremented in multiples of 30 seconds

1 0 1 value is incremented in multiples of 1 minute

1 1 0 value is incremented in multiples of 320 hours

1 1 1 value indicates that the timer is deactivated.

Example: 10101100 -> 101 means values is incremented in multiples of 1 minute, 01100 means 12 -> the obtained value is 12 minutes

T3324 value:

Bits 5 to 1 represent the binary coded timer value.

Bits 6 to 8 defines the timer value unit for the GPRS timer as follows:

Bits

8 7 6

0 0 0 value is incremented in multiples of 2 seconds

0 0 1 value is incremented in multiples of 1 minute

0 1 0 value is incremented in multiples of decihours

1 1 1 value indicates that the timer is deactivated.



```
AT+CPSMS=1,,,"10101100","00100010"
OK
```

```
AT+CPSMS?
+CPSMS: 1,,,"10101100","00100010"
OK
```

It means that module requires to adopt the PSM for reducing its power consumption. If the network supports PSM and accepts that the UE uses PSM with requested timers value, module enters in PSM when the active timer expires (T3324=2 minutes) and stay in this mode for ten minutes (T3412=12 minutes).

```
AT+CPSMS=0
OK
```

It means that PSM is set to disable, the module does not go to Power Saving Mode in any case.

3.25.2. AT#CPSMS - Power Saving Mode Setting

This command enables/disables Power Saving Mode (PSM) mode.

SIM Presence	Setting saved	Can be aborted	MAX timeout	SELINT
Required	Auto	No	-	2

 **AT#CPSMS=[<mode>[,<ReqPeriodicRAU>[,<ReqGPRSreadyTimer>[,<ReqPeriodicTAU>[,<ReqActiveTime>]]]]]**

The set command controls the setting of the UEs power saving mode (PSM) parameters. The command controls whether the UE wants to apply PSM or not, as well as the requested extended periodic RAU value and the requested GPRS READY timer value in GERAN, the requested extended periodic TAU value in E-UTRAN and the requested Active Time value.

This command, unlike the **+CPSMS** command, accepts the parameters in integer format.

Parameters:

Name	Type	Default	Description
<mode>	integer	0	disables or enables the use of PSM in the UE.
Values:			
	0	:	disable
	1	:	enable
<ReqPeriodicRAU>	integer	-	requested extended periodic RAU value (T3312) to be allocated to the UE in GERAN. Parameter expressed in sec.
<ReqGPRSreadyTimer>	integer	-	requested GPRS READY timer value (T3314) to be allocated to the UE in GERAN. Parameter expressed in sec.
<ReqPeriodicTAU>	integer	-	requested extended periodic TAU value (T3412) to be allocated to the UE in E-UTRAN. Parameter expressed in sec.
<ReqActiveTime>	integer	-	requested Active Time value (T3324) to be allocated to the UE. Parameter expressed in sec.

 A special form of the command can be given as **AT#CPSMS=** (with all parameters omitted). In this form, the parameter **<mode>** will be set to 0, the use of PSM will be disabled and data for all parameters in command **#CPSMS** will be removed or, if available, set to the manufacturer specific default values.

 CPSMS configuration is saved in the file system.

 **AT#CPSMS?**

Read command presents the current CPSMS configuration returned by the network, in the format:

#CPSMS: <status>[,<T3324>,<T3412 or T3412EXT>]

Additional info:

►► Meaning of the returned parameters.

Name	Type	Default	Description
<status>	integer	0	PSM status in the network
Values:			
0 : PSM disabled			
1 : PSM enabled			
<T3324>	integer	-	T3324 timer value in the network, in seconds (could be different from the requested one)
<T3412/T3412EXT>	integer	-	T3412 or T3412Ext timer value in the network, in seconds (could be different from the requested one).



AT#CPSMS=?

Test command returns **OK** result code.

4. LIST OF ACRONYMS

Acronym	Meaning
ARFCN	Absolute Radio Frequency Channel Number
AT	Attention command
BA	BCCH Allocation
BCCH	Broadcast Control Channel
CA	Cell Allocation
CBM	Cell Broadcast Message
CBS	Cell Broadcast Service
CCM	Current Call Meter
CLIR	Calling Line Identification Restriction
CTS	Clear To Send
CUG	Closed User Group
DCD	Data Carrier Detect
DCE	Data Communication Equipment
DCS	Digital Cellular System
DGPS	Differential GPS, the use of GPS measurements, which are differentially corrected
DNS	Domain Name System
DSR	Data Set Ready
DTE	Data Terminal Equipment
DTMF	Dual Tone Multi Frequency
DTR	Data Terminal Ready
GGA	GPS Fix data
GLL	Geographic Position – Latitude/Longitude
GLONASS	Global positioning system maintained by the Russian Space Forces
GMT	Greenwich Mean Time
GNSS	Any single or combined satellite navigation system (GPS, GLONASS and combined GPS/GLONASS)
GPRS	Global Packet Radio Service
GPS	Global Positioning System
GSA	GPS DOP and Active satellites
GSM	Global System Mobile
GSV	GPS satellites in view
HDLC	High Level Data Link Control
HDOP	Horizontal Dilution of Precision
IMEI	International Mobile Equipment Identity
IMSI	International Mobile Subscriber Identity
IP	Internet Protocol
IRA	International Reference Alphabet
IWF	Interworking Function
ME	Mobile Equipment
MO	Mobile Originated
MT	<i>either</i> Mobile Terminated <i>or</i> Mobile Terminal
NMEA	National Marine Electronics Association
NVM	Non-Volatile Memory
PCS	Personal Communication Service
PDP	Packet Data Protocol
PDU	Packet Data Unit
PIN	Personal Identification Number
PPP	Point to Point Protocol
PUK	Pin Unblocking Code
RLP	Radio Link Protocol
RMC	Recommended minimum Specific data
RTS	Request To Send
SAP	SIM Access Profile
SCA	Service Center Address
SMS	Short Message Service
SMSC	Short Message Service Center
SMTP	Simple Mail Transport Protocol
TA	Terminal Adapter
TCP	Transmission Control Protocol
TE	Terminal Equipment
UDP	User Datagram Protocol
USSD	Unstructured Supplementary Service Data
UTC	Coordinated Universal Time
VDOP	Vertical dilution of precision
VTG	Course over ground and ground speed
WAAS	Wide Area Augmentation System

5. DOCUMENT HISTORY

Revision	Date	Changes
0	2017-03-10	First release
1	2017-08-14	Updated applicability table
2	2017-09-14	Updated applicability table Updated Commands and Aligned to first Mass Production Release 30.00.xx2
3	2018-06-26	Updated template Updated to SW M0B.xx0003 (modem version) / 30.00.xx3 (package version) Updated Commands: +GSN, #CGSN, +CGSN, #CGMM, +ICF, +COPS, +CLCK, +CPWD, #BND, #RFSTS, #WS46, +CEDRXRDP, +CEDRXS, +CEMODE, +CESQ, #CCLKMODE, +CSAS, +CRES, +CMGR, +CGEREP, +CGREG, #GAUTH, +CGACT, +CGDCONT, +CGDSCONT, #QSS, +CSIM, #TEMPMON, #ADC, #V24CFG, #SGACT, #QDNS, #SCFGEXT, #SGACTCFG, #SGACTCFGEXT, #GDATAVOL, #SLASTCLOSURE, #NWDNS, #FTPOPEN, #HTTPCFG, #HTTPCRV, #SSLCFG, #SLEN, #SSLSECDATA, \$LCSSLP, \$SUPLCFG, \$SUPLV, \$GPSSLSR, \$GPSAV, +CPSMS
4	2018-10-24	New Commands: #SELINT, &Y, &W, &N, #Z, &V0, +GCI, +GCAP, #CGMF, #SWPKG, +CPAS, +CSVM, #MBN, #MWI, #LANG, +CEER, #CEER, #PSMRI, #PORTCFG, #ATDELAY, &Z, &V2, &V1, &V3, ATX, &S, #E2ESC, ATH, ATO, %E, +CREG, +CUSD, #SPN, #NWEN, #PLMNMODE, #AUTOBND, #SNUM, #CEERNET, #CIPHIND, #ENCALG, +CEREG, #ENS, #CEDRXS, +CAPD, +CSDF, +CSTF, +CTZR, +CTZU, #CCLK, +CMMS, +CNMA, +CGSMS, #SMSMOVE, #SMSMODE, #CMGLCONCINDEX, #E2SMSRI, +CPBR, +CPBF, +CPBW, #CPBGR, #CPBGW, #CPBD, +CGSCONTRDP, +CGQMIN, +CGQREG, #AUTOATT, #MSCLASS, +CGAUTH, +CCID, #SIMPR, +CCHO, +CGLA, #VSIMSETPROF, +ICCID, #STIA, #STGI, #STSR, #SLED, #SLEDSAV, #V24, #I2CCF, #SGACTAUTH, #SLASTCLOSURE, #BASE64, #ICMP, #PING, #SSLSECCFG2, #SSLSENDEXT, #SSLI, +CCIOTOPT, #M2MRITE, #M2MDEL, #M2MLIST, #M2MREAD, #CPSMS
5	2019-01-31	Updated Command descriptions: #GPIO, #SSLSECDATA, #MONI, +CGQMIN, +CGQREQ, +COPS, #SERVINFO, #PSNT, +CEREG, +CNMI, +CMGW, \$LCSLUI, +CSQ, +CESQ, +CGDSCONT, \$SUPLSEC, +CGATT, #MSCLASS, #TEMPMON, #TEMPCFG, #SGACTCFG, +CGSCONTRDP, #GAUTH, #SGACTAUTH, #SGACTCFGEXT, #GDATAVOL, #QDNS, #FTPOPEN, #SSLD, #SSLO, #BND, +CGREG, #PSMRI, #E2ESC, +CPWD, #NITZ, +CGEREP, #CSURV, #CSURVC, #CSURVEXT, +CPSMS, #CPSMS, #CEERNET, +CRSM, +CSIM, +CPOL, +CGLA, \$GPSNMUNEX, ATX, ATD, ATH, ATO, #ENCALG, #RFSTS Added Command descriptions: \$GPSSW, #TESTMODE, #SHDN, #FASTSHDN

		Updated to SW M0B.xx0003 (modem version) / 30.00.xx4 (package version) the Applicability Table.
6	2019-05-14	<p>Updated Command description: #SELINT, &Z, &N, +CPAS, +CFUN, &K, #RFSTS, #PLMNMODE, #CEERNET, +CEREG, #WS46, #CEDRXS, +CCLK, +CALA, +CALD, +CSTF, +CPMS, +CMGS, +CMGW, #STIA, #SHDN, #FASTSHDN, #GPIO, #SLED, #SCFGEXT2, #SCFGEXT3, #SSEND, #SSENDEXT, #SSENDUDP, #SSENDUDPEXT, #SS, #BASE64, #PING, #FTPCFG, #HTTPCFG, #HTTPSND, #FWSWITCH.</p> <p>Added Command description: +CMUX, #JDRENH2, #JDR4GCFG, #CSURVF, #CSURVNLf, #CCIOTOPT.</p>
7	2019-06-28	Updated Command description: #CEERNET
		The Applicability Table has been updated to SW M0B.xx0003 (modem version) / 30.00.xx5 (package version).
8	2019-07-04	<p>Updated Commands descriptions: AT+GCAP, AT#USBCFG, AT+COPS, AT+CSQ, AT+CGEREP, AT+CGSCONTRDP, AT#SKTRST, AT#HTTPCFG, AT+CCIOTOPT, AT\$SLP, AT#SWPKGv.</p> <p>Added Commands descriptions: AT#CEERNETEXT, AT#ECM, AT#ECMD, AT#NTP, AT#NTPCFG, AT#ESMTP, AT#EADDR, AT#SMTPCFG, AT#EUSER, AT#EPASSW, AT#ESAV, AT#ERST, AT#EMAILD, AT#EMAILMSG, AT#NIPDCFG, AT#NIPDCONN, AT#NIPDSEND, AT#NIPDRECV, AT#OTAUPW, AT#M2MMKDIR, AT#M2MRMDIR, AT#M2MRUN, AT+M2M, AT#M2MBACKUP, AT+CIND.</p>
9	2019-08-01	The Applicability Table has been updated: M0B.xx0003 (modem version) to M0B.xx0004, added modules: ME910C1-P1, ME910C1-P2.



SUPPORT INQUIRIES

Link to www.telit.com and contact our technical support team for any questions related to technical issues.

www.telit.com



Telit Communications S.p.A.
Via Stazione di Prosecco, 5/B
I-34010 Sgonico (Trieste), Italy

Telit Wireless Solutions Inc.
3131 RDU Center Drive, Suite 135
Morrisville, NC 27560, USA

Telit Wireless Solutions Ltd.
10 Habarzel St.
Tel Aviv 69710, Israel

Telit IoT Platforms LLC
5300 Broken Sound Blvd, Suite 150
Boca Raton, FL 33487, USA

Telit Wireless Solutions Co., Ltd.
8th Fl., Shinyoung Securities Bld.
6, Gukjegeumyung-ro8-gil, Yeongdeungpo-gu
Seoul, 150-884, Korea

Telit Wireless Solutions
Tecnologia e Servicos Ltda
Avenida Paulista, 1776, Room 10.C
01310-921 São Paulo, Brazil