



LT Series LoRa IO Controller User Manual

Document Version: 1.5.7

Image Version: v1.5.4

Version	Description	Date
1.0	Release	2018-Sep-26
1.0.2	Add 8 channels mode for US915, AU915, CN470	2018-Oct-24
1.0.3	Add current measure photo	2018-Nov-2
1.0.4	Add Cayenne connection guide	2018-Nov-24
1.1	Add downlink trouble shooting, Add Hardware Source code link. Add change log for v1.1. (related to Downlink, Payload part) Add TTN payload format	2019-Jan-24
1.1.1	Add more info for 8 channel mode descript and troubleshooting while use US915 and AU915	2019-Feb-21
1.1.2	Modify trouble shooting for upload via FlashLoader,	2019-Apr-26

	Correct the TTN payload decoder	
1.2.0	Add Counting Mode Improve description of single channel gateway compatible	
1.2.1	Adjust Downlink instruction while using with LG01-N and LG02	2019-5-7
1.3.0	Add new feature on downlink, able to control the relay base on timing	2019-Aug-9
1.3.1	Add Power ON info	2019-Aug-20
1.4.0	Add LT-22222-L description and support. Add Decode in LoRaserver	2020-Mar-7
1.4.1	Modify Downlink trouble shooting, Add MyDevice Photo	2020-Mar-28
1.4.2	Add Upgrade info for v1.4.2 firmware version	2020-Mar-30
1.5.0	Add MOD=6, MOD=7	2020-Jul-20
1.5.1	Add trigger to uplink	2020-Sep-25
1.5.4	Modify content to support v1.5.4 firmware	2020-Dec-30
1.5.5	Fix typo for upgrade LED status	2021-Jan-13
1.5.6	Add FAQ for counting	2022-Jan-25
1.5.7	Add wiring example for analog input to 4~20mA sensor	2022-Feb-26

1. Introduction	6
1.1 What is LT Series I/O Controller	6
1.2 Specifications	7
1.3 Features	8
1.4 Applications	8
1.5 Hardware Variants	9
1.6 Firmware Change log	9
2. Power ON Device	10
3. Operation Mode	11
3.1 How it works?	11
3.2 Example to join LoRaWAN network	11
3.3 Uplink Payload	13
3.3.1 AT+MOD=1, 2ACI+2AVI	13
3.3.2 AT+MOD=2, (Double DI Counting)	14
3.3.3 AT+MOD=3, Single DI Counting + 2 x ACI	15
3.3.4 AT+MOD=4, Single DI Counting + 1 x Voltage Counting	16
3.3.5 AT+MOD=5, Single DI Counting + 2 x AVI + 1 x ACI	16
3.3.6 AT+ADDMOD=6. (Trigger Mode, Optional)	18
3.3.7 Payload Decoder	20
3.4 Configure LT via AT or Downlink	21
3.4.1 Common Commands:	21
3.4.2 Sensor related commands:	21
Set Transmit Interval	21
Set Work Mode (AT+MOD)	21
Poll an uplink	22
Enable Trigger Mode	22
Poll trigger settings	22
Enable / Disable DI1/DI2/DI3 as trigger	22
Trigger1 – Set DI1 or DI3 as trigger	23
Trigger2 – Set DI2 as trigger	23
Trigger – Set AC (current) as trigger	23
Trigger – Set AV (voltage) as trigger	23
Trigger – Set minimum interval	24
DO -- Control Digital Output DO1/DO2/DO3	24
DO -- Control Digital Output DO1/DO2/DO3 with time control	24

Relay -- Control Relay Output RO1/RO2	25
Relay -- Control Relay Output RO1/RO2 with time control	26
Counting -- Voltage threshold counting	28
Counting -- Pre-configure the Count Number	28
Counting -- Clear Counting	29
Counting -- Change counting mode save time	30
3.5 Integrate with Mydevice.....	30
3.6 Interface Detail.....	33
3.6.1 Digital Input Port: DI1/DI2 /DI3 (For LT-33222-L, low active).....	33
3.6.2 Digital Input Port: DI1/DI2 (For LT-22222-L).....	34
3.6.3 Digital Output Port: DO1/DO2 /DO3	35
3.6.4 Analog Input Interface	36
3.6.5 Relay Output.....	37
3.7 LEDs Indicators	38
4. Use AT Command.....	39
4.1 Access AT Command.....	39
4.2 Common AT Command Sequence.....	41
4.2.1 Multi-channel ABP mode (Use with SX1301/LG308)	41
4.2.2 Single-channel ABP mode (Use with LG01/LG02).....	41
4.2.3 Change to Class A.....	42
5. FAQ.....	43
5.1 How to upgrade the image?.....	43
5.2 How to change the LoRa Frequency Bands/Region?.....	45
5.3 How to set up LT to work with Single Channel Gateway such as LG01/LG02?	45
5.4 Can I see counting event in Serial?	47
6. Trouble Shooting.....	48
6.1 Downlink doesn't work, how to solve it?.....	48
6.2 Have trouble to upload image.....	48
6.3 Why I can't join TTN in US915 /AU915 bands?.....	48
7. Order Info	48
8. Packing Info	48
9. Support.....	49
10. Reference	50

1. Introduction

1.1 What is LT Series I/O Controller

The Dragino LT series I/O Modules are Long Range LoRaWAN I/O Controller. It contains different I/O Interfaces such as: analog current Input, analog voltage input, relay output, digital input and digital output etc. The LT I/O Modules are designed to simplify the installation of I/O monitoring.

The LT I/O Controllers allows the user to send data and reach extremely long ranges. It provides ultra-long range spread spectrum communication and high interference immunity whilst minimizing current consumption. It targets professional wireless sensor network applications such as irrigation systems, smart metering, smart cities, smartphone detection, building automation, and so on.

The LT I/O Controllers is aiming to provide a simple plug and play, low cost installation by using LoRaWAN wireless technology.

The use environment includes:

- 1) If user's area has LoRaWAN service coverage, they can just install the I/O controller and configure it to connect the LoRaWAN provider via wireless.
- 2) User can set up a LoRaWAN gateway locally and configure the controller to connect to the gateway via wireless.

LoRa I/O Controller Network Structure

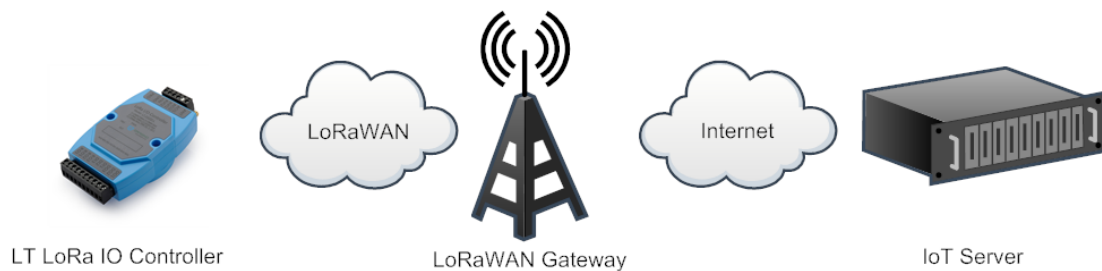

1.2 Specifications

Hardware System:

- STM32L072CZT6 MCU
- SX1276/78 Wireless Chip
- Power Consumption:
 - ✧ Idle: 4mA@12v
 - ✧ 20dB Transmit: 34mA@12v

Interface for Model: LT33222-L:

- 3 x Digital Input (Detect Low signal , Max, 6V)
- 3 x Digital Output (NPN output. Max pull up voltage 36V,450mA)
- 2 x Relay Output (5A@250VAC / 30VDC)
- 2 x 0~20mA Analog Input (res:0.01mA)
- 2 x 0~30V Analog Input (res:0.01v)
- Power Input 7~ 24V DC.
-

Interface for Model: LT22222-L:

- 2 x Digital dual direction Input (Detect High/Low signal, Max: 50v, or 220v with optional external resistor)
- 2 x Digital Output (NPN output. Max pull up voltage 36V,450mA)
- 2 x Relay Output (5A@250VAC / 30VDC)
- 2 x 0~20mA Analog Input (res:0.01mA)
- 2 x 0~30V Analog Input (res:0.01v)
- Power Input 7~ 24V DC.

LoRa Spec:

- Frequency Range:
 - ✓ Band 1 (HF): 862 ~ 1020 Mhz
 - ✓ Band 2 (LF): 410 ~ 528 Mhz
- 168 dB maximum link budget.
- +20 dBm - 100 mW constant RF output vs.
- +14 dBm high efficiency PA.
- Programmable bit rate up to 300 kbps.
- High sensitivity: down to -148 dBm.
- Bullet-proof front end: IIP3 = -12.5 dBm.
- Excellent blocking immunity.
- Low RX current of 10.3 mA, 200 nA register retention.
- Fully integrated synthesizer with a resolution of 61 Hz.
- FSK, GFSK, MSK, GMSK, LoRaTM and OOK modulation.
- Built-in bit synchronizer for clock recovery.
- Preamble detection.

- 127 dB Dynamic Range RSSI.
- Automatic RF Sense and CAD with ultra-fast AFC.
- Packet engine up to 256 bytes with CRC.

1.3 Features

- ✓ LoRaWAN Class A & Class C protocol
- ✓ Optional Customized LoRa Protocol
- ✓ Frequency Bands: CN470/EU433/KR920/US915/EU868/AS923/AU915/RU864/IN865
- ✓ AT Commands to change parameters
- ✓ Remote configure parameters via LoRa Downlink
- ✓ Firmware upgradable via program port
- ✓ Counting

1.4 Applications

- ✓ Smart Buildings & Home Automation
- ✓ Logistics and Supply Chain Management
- ✓ Smart Metering
- ✓ Smart Agriculture
- ✓ Smart Cities
- ✓ Smart Factory

1.5 Hardware Variants

Model	Photo	Description
LT33222-L		<ul style="list-style-type: none"> ✓ 3 x Digital Input ✓ 3 x Digital Output ✓ 2 x Relay Output (5A@250VAC / 30VDC) ✓ 2 x 0~20mA Analog Input (res:0.01mA) ✓ 2 x 0~30V Analog Input (res:0.01v) ✓ 1 x Counting Port

Model	Photo	Description
LT22222-L		<ul style="list-style-type: none"> ✓ 2 x Digital Input (Bi-direction) ✓ 2 x Digital Output ✓ 2 x Relay Output (5A@250VAC / 30VDC) ✓ 2 x 0~20mA Analog Input (res:0.01mA) ✓ 2 x 0~30V Analog Input (res:0.01v) ✓ 1 x Counting Port

1.6 Firmware Change log

LT Image files:

http://www.dragino.com/downloads/index.php?dir=LT_LoRa_IO_Controller/LT33222-L/image/

Change log:

http://www.dragino.com/downloads/index.php?dir=LT_LoRa_IO_Controller/LT33222-L/image/&file=changelog

2. Power ON Device

The LT controller can be powered by 7 ~ 24V DC power source. Connect VIN to Power Input V+ and GND to power input V- to power the LT controller.

PWR will on when device is properly powered.



3. Operation Mode

3.1 How it works?

The LT is configured as LoRaWAN OTAA Class C mode by default. It has OTAA keys to join network. To connect a local LoRaWAN network, user just need to input the OTAA keys in the network server and power on the LT. It will auto join the network via OTAA. For LT-22222-L, the LED will show the Join status: After power on TX LED will fast blink 5 times, LT-22222-L will enter working mode and start to JOIN LoRaWAN network. TX LED will be on for 5 seconds after joined in network. When there is message from server, the RX LED will be on for 1 second.

In case user can't set the OTAA keys in the network server and has to use the existing keys from server. User can [use AT Command](#) to set the keys in the devices.

3.2 Example to join LoRaWAN network

This chapter shows an example for how to join the TTN LoRaWAN Network. Below is the network structure, we use our LG308 as LoRaWAN gateway here.

[Use LT33222 + LG308 in TTN network](#)



The LG308 is already set to connect to [TTN network](#). So what we need to do now is only configure register this device to TTN:

Step 1: Create a device in TTN with the OTAA keys from LT IO controller.

Each LT is shipped with a sticker with the default device EUI as below:



Input these keys in the LoRaWAN Server portal. Below is TTN screen shot:
Add APP EUI in the application.

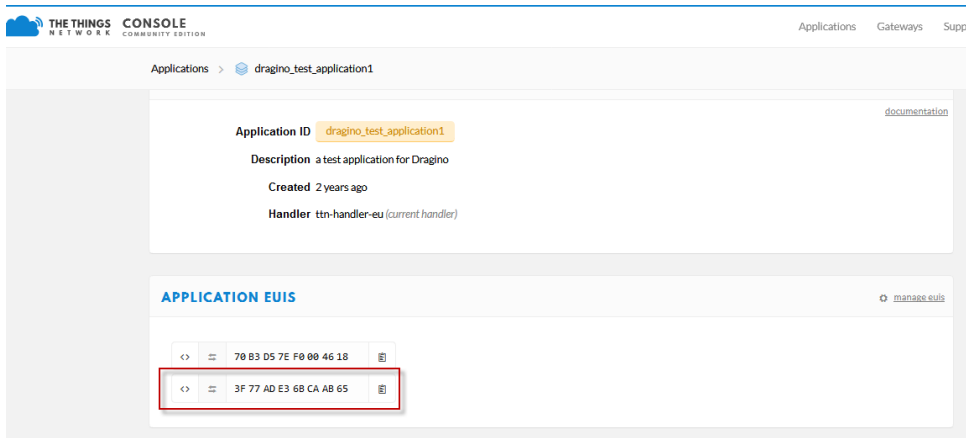

Add APP KEY and DEV EUI

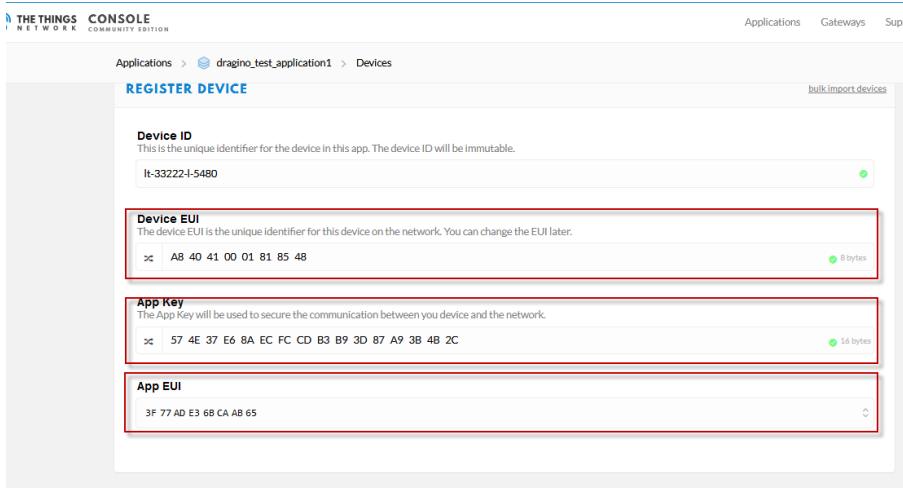

Step 2: Power on LT and it will auto join to the TTN network. After join success, it will start to upload message to TTN and user can see in the panel.

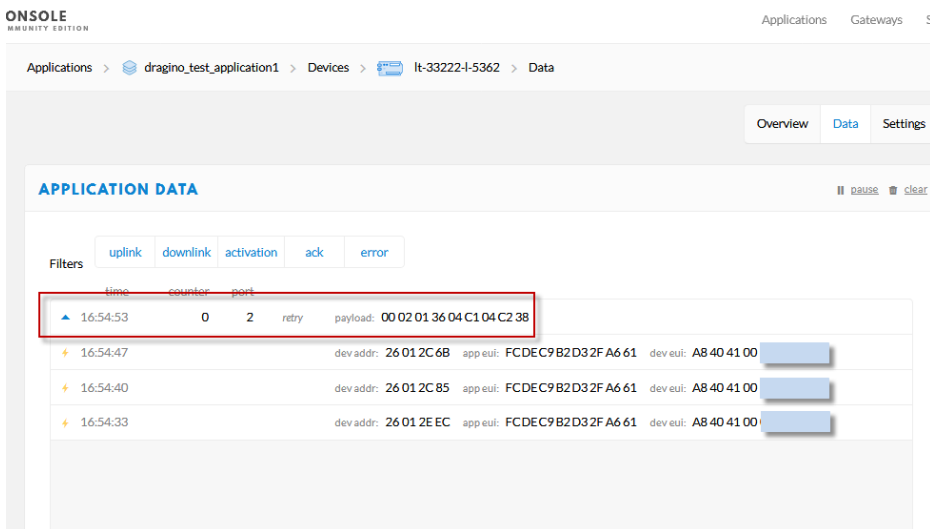

3.3 Uplink Payload

There are five working modes + one interrupt mode on LT for different type application:

- ✓ [MOD1](#): (default setting): 2 x ACI + 2AVI + DI + DO + RO
- ✓ [MOD2](#): Double DI Counting + DO + RO
- ✓ [MOD3](#): Single DI Counting + 2 x ACI + DO + RO
- ✓ [MOD4](#): Single DI Counting + 1 x Voltage Counting + DO + RO
- ✓ [MOD5](#): Single DI Counting + 2 x AVI + 1 x ACI + DO + RO
- ✓ [ADDMOD6](#): Trigger Mode, Optional, used together with MOD1 ~ MOD5

3.3.1 AT+MOD=1, 2ACI+2AVI

The uplink payload includes totally 9 bytes. Uplink packets use FPORT=2 and every 10 minutes send one uplink by default.

Size(bytes)	2	2	2	2	1	1	1
Value	AVI1 voltage	AVI2 voltage	ACI1 Current	ACI2 Current	DIDORO*	Reserve	MOD

DIDORO is a combination for RO1, RO2, DI3, DI2, DI1, DO3, DO2 and DO1. Totally 1bytes as below

bit7	bit6	bit5	bit4	bit3	bit2	bit1	bit0
RO1	RO2	DI3	DI2	DI1	DO3	DO2	DO1

- ✓ RO is for relay. ROx=1 : close, ROx=0 always open.
- ✓ DI is for digital input. DIx=1: high or float, DIx=0: low.
- ✓ DO is for reverse digital output. DOx=1: output low, DOx=0: high or float.

Note: DI3 and DO3 bit are not valid for LT-22222-L

For example if payload is: 04 AB 04 AC 13 10 13 00 AA FF 01

The value for the interface is:

AVI1 channel voltage is $0x04AB/1000=1195$ (DEC) /1000=1.195V

AVI2 channel voltage is $0x04AC/1000=1.196V$

ACI1 channel current is $0x1310/1000=4.880mA$

ACI2 channel current is $0x1300/1000=4.864mA$

The last byte 0xAA= 10101010(B) means

- ✓ [1] RO1 relay channel is close and the RO1 LED is ON.
 - ✓ [0] RO2 relay channel is open and RO2 LED is OFF;
- LT33222-L:**
- ✓ [1] DI3 channel is high input and DI3 LED is OFF;
 - ✓ [0] DI2 channel is low input;
 - ✓ [1] DI1 channel is high input and DI1 LED is OFF;
- LT22222-L:**
- ✓ [1] DI2 channel is high input and DI2 LED is ON;

- ✓ [0] DI1 channel is low input;
- ✓ [0] DO3 channel output state
 - ✧ DO3 is float in case no load between DO3 and V+;
 - ✧ DO3 is high in case there is load between DO3 and V+.
 - ✧ DO3 LED is off in both case
- ✓ [1] DO2 channel output is low and DO2 LED is ON.
- ✓ [0] DO1 channel output state
 - ✧ DO1 is float in case no load between DO1 and V+;
 - ✧ DO1 is high in case there is load between DO1 and V+.
 - ✧ DO1 LED is off in both case

3.3.2 AT+MOD=2, (Double DI Counting)

For LT-33222-L: this mode the [DI3](#) is used as a counting pin. Counting on DI3 reflect in COUNT1.

For LT-22222-L: this mode the [DI1 and DI2](#) are used as counting pins.

Total : 11 bytes payload

Size(bytes)	4	4	1	1	1
Value	COUNT1	COUNT2	DIDORO*	Reserve	MOD

DIDORO is a combination for RO1, RO2, DO3, DO2 and DO1. Totally 1bytes as below

bit7	bit6	bit5	bit4	bit3	bit2	bit1	bit0
RO1	RO2	FIRST	Reserve	Reserve	DO3	DO2	DO1

- ✓ RO is for relay. ROx=1 : close, ROx=0 always open.
- ✓ FIRST: Indicate this is the first packet after join network.
- ✓ DO is for reverse digital output. DOx=1: output low, DOx=0: high or float.

Note: DO3 bit is not valid for LT-22222-L.

To use counting mode, please run:

```
AT+MOD=2
```

```
ATZ
```

AT Commands for counting:

For LT33222-L:

```
AT+TRIG1=0,100 (set DI3 port to trigger on low level, valid signal is 100ms)
```

```
AT+TRIG1=1,100 (set DI3 port to trigger on high level, valid signal is 100ms )
```

```
AT+SETCNT=1,60 (Set COUNT1 value to 60)
```

For LT22222-L:

```
AT+TRIG1=0,100 (set DI1 port to trigger on low level, valid signal is 100ms)
```

AT+TRIG1=1,100(set DI1 port to trigger on high level, valid signal is 100ms)

AT+TRIG2=0,100 (set DI2 port to trigger on low level, valid signal is 100ms)

AT+TRIG2=1,100 (set DI2 port to trigger on high level, valid signal is 100ms)

AT+SETCNT=1,60 (Set COUNT1 value to 60)

AT+SETCNT=2,60 (Set COUNT2 value to 60)

For both LT22222-L & LT33222-L:

AT+CLRCOUNT clear all countings

AT+COUTIME=60 Set save time to 60 seconds. Device will save the counting result in internal flash every 60 seconds. (min value: 30)

3.3.3 AT+MOD=3, Single DI Counting + 2 x ACI

LT33222-L: This mode the DI3 is used as a counting pin.

LT22222-L: This mode the DI1 is used as a counting pin.

Size(bytes)	4	2	2	1	1	1
Value	COUNT1	ACI1 Current	ACI2 Current	DIDORO*	Reserve	MOD

DIDORO is a combination for RO1, RO2, DI3, DI2, DI1, DO3, DO2 and DO1. Totally 1bytes as below

bit7	bit6	bit5	bit4	bit3	bit2	bit1	bit0
RO1	RO2	FIRST	Reserve	Reserve	DO3	DO2	DO1

- ✓ RO is for relay. ROx=1 : close, ROx=0 always open.
- ✓ FIRST: Indicate this is the first packet after join network.
- ✓ DO is for reverse digital output. DOx=1: output low, DOx=0: high or float.

Note: DO3 is not valid for LT-22222-L.

To use counting mode, please run:

AT+MOD=3

ATZ

Other AT Commands for counting are similar to [MOD2 Counting Command](#).

3.3.4 AT+MOD=4, Single DI Counting + 1 x Voltage Counting

LT33222-L: This mode the DI3 is used as a counting pin.

LT22222-L: This mode the DI1 is used as a counting pin.

The AVI1 is also used for counting. AVI1 is used to monitor the voltage. It will check the voltage **every 60s**, if voltage is higher or lower than **VOLMAX** mV, the AVI1 Counting increase 1, so AVI1 counting can be used to measure a machine working hour.

Size(bytes)	4	4	1	1	1
Value	COUNT1	AVI1 Counting	DIDORO*	Reserve	MOD

DIDORO is a combination for RO1, RO2, DI3, DI2, DI1, DO3, DO2 and DO1. Totally 1bytes as below

bit7	bit6	bit5	bit4	bit3	bit2	bit1	bit0
RO1	RO2	FIRST	Reserve	Reserve	DO3	DO2	DO1

- ✓ RO is for relay. ROx=1 : close, ROx=0 always open.
- ✓ FIRST: Indicate this is the first packet after join network.
- ✓ DO is for reverse digital output. DOx=1: output low, DOx=0: high or float.

Note: DO3 is not valid for LT-22222-L.

To use this mode, please run:

```
AT+MOD=4
```

```
ATZ
```

Other AT Commands for counting are similar to [MOD2 Counting Command](#).

Plus below command for AVI1 Counting:

```
AT+SETCNT=3,60 (set AVI Count to 60)
```

```
AT+VOLMAX=20000 (If AVI1 voltage higher than VOLMAX (20000mV =20v), counter increase 1)
```

```
AT+VOLMAX=20000,0 (If AVI1 voltage lower than VOLMAX (20000mV =20v), counter increase 1)
```

```
AT+VOLMAX=20000,1 (If AVI1 voltage higer than VOLMAX (20000mV =20v), counter increase 1)
```

3.3.5 AT+MOD=5, Single DI Counting + 2 x AVI + 1 x ACI

LT33222-L: This mode the DI3 is used as a counting pin.

LT22222-L: This mode the DI1 is used as a counting pin.

Size(bytes)	2	2	2	2	1	1	1
Value	AVI1 voltage	AVI2 voltage	ACI1 Current	COUNT1	DIDORO*	Reserve	MOD

DIDORO is a combination for RO1, RO2, DI3, DI2, DI1, DO3, DO2 and DO1. Totally 1bytes as below

bit7	bit6	bit5	bit4	bit3	bit2	bit1	bit0
RO1	RO2	FIRST	Reserve	Reserve	DO3	DO2	DO1

- ✓ RO is for relay. ROx=1 : close, ROx=0 always open.
- ✓ FIRST: Indicate this is the first packet after join network.
- ✓ DO is for reverse digital output. DOx=1: output low, DOx=0: high or float.

Note: DO3 is not valid for LT-22222-L.

To use this mode, please run:

```
AT+MOD=5
```

```
ATZ
```

Other AT Commands for counting are similar to [MOD2 Counting Command](#).

3.3.6 AT+ADDMOD=6. (Trigger Mode, Optional)

This mode is an optional mode for trigger purpose. It can run together with other mode.

For example, if user has configured below commands:

- ✓ AT+MOD=1 → The normal working mode
- ✓ AT+ADDMOD=6 → Enable trigger

LT will keep monitoring AV1/AV2/AC1/AC2 every 5 seconds; LT will send uplink packets in two cases:

1. Periodically uplink (Base on TDC time). Payload is same as the normal MOD (MOD 1 for above command). This uplink uses LoRaWAN **unconfirmed** data type
2. Trigger uplink when meet the trigger condition. LT will sent two packets in this case, the first uplink use payload specify in this mod (mod=6), the second packets use the normal mod payload(MOD=1 for above settings). Both Uplinks use LoRaWAN **CONFIRMED data type**.

AT Command to set Trigger Condition:

Trigger base on voltage:

Format: AT+AVLIM=<AV1_LIMIT_LOW>,< AV1_LIMIT_HIGH>,<AV2_LIMIT_LOW>,< AV2_LIMIT_HIGH>

Example:

AT+AVLIM=3000,6000,0,2000 (If AV11 voltage lower than 3v or higher than 6v. or AV2 voltage is higher than 2v, LT will trigger Uplink)

AT+AVLIM=5000,0,0,0 (If AV11 voltage lower than 5V , trigger uplink, 0 means ignore)

Trigger base on current:

Format: AT+ACLIM=<AC1_LIMIT_LOW>,< AC1_LIMIT_HIGH>,<AC2_LIMIT_LOW>,< AC2_LIMIT_HIGH>

Example:

AT+ACLIM=10000,15000,0,0 (If AC11 voltage lower than 10mA or higher than 15mA, trigger an uplink)

Trigger base on DI status:

DI status trigger Flag.

Format: AT+DTRI=<DI1_TIRGGER_FIAG>,< DI2_TIRGGER_FIAG >

Example:

AT+ DTRI =1,0 (Enable DI1 trigger / disable DI2 trigger)

Downlink Command to set Trigger Condition

Type Code: 0xAA. Downlink command same as AT Command [AT+AVLIM, AT+ACLIM](#)

Format:

AA	xx	yy1 yy1	yy2 yy2	yy3 yy3	yy4 yy4
----	----	---------	---------	---------	---------

AA: Code for this downlink Command:

xx: 0: Limit for AV1 and AV2; 1: limit for AC1 and AC2 ; 2 DI1, DI2 trigger enable/disable

yy1 yy1: AC1 or AV1 low limit or DI1/DI2 trigger status.

yy2 yy2: AC1 or AV1 high limit.

yy3 yy3: AC2 or AV2 low limit.

yy4 yy4: AC2 or AV2 high limit.

Example1: AA 00 13 88 00 00 00 00 00

Same as AT+AVLIM=5000,0,0,0 (If AV11 voltage lower than 5V , trigger uplink, 0 means ignore)

Example2: AA 02 01 00

Same as AT+ DTRI =1,0 (Enable DI1 trigger / disable DI2 trigger)

Trigger Settings Payload Explanation:

MOD6 Payload : total 11 bytes payload

Size(bytes)	1	1	1	6	1	1
Value	TRI_A FLAG	TRI_A Status	TRI_DI FLAG+STA	Reserve	Enable/Disable MOD6	MOD (6)

TRI FLAG1 is a combination to show if trigger is set for this part. Totally 1byte as below

bit7	bit6	bit5	bit4	bit3	bit2	bit1	bit0
AV1_ LOW	AV1_ HIGH	AV2_ LOW	AV2_ HIGH	AC1_ LOW	AC1_ HIGH	AC2_ LOW	AC2_ HIGH

✓ Each bits shows if the corresponding trigger has been configured.

Example:

10100000: Means the system has configure to use the trigger: AC1_LOW and AV2_LOW

TRI Status1 is a combination to show which condition is trigger. Totally 1byte as below

bit7	bit6	bit5	bit4	bit3	bit2	bit1	bit0
AV1_ LOW	AV1_ HIGH	AV2_ LOW	AV2_ HIGH	AC1_ LOW	AC1_ HIGH	AC2_ LOW	AC2_ HIGH

✓ Each bits shows which status has been trigger on this uplink.

Example:

10000000: Means this packet is trigger by AC1_LOW. Means voltage too low.

TRI_DI FLAG+STA is a combination to show which condition is trigger. Totally 1byte as below

bit7	bit6	bit5	bit4	bit3	bit2	bit1	bit0
N/A	N/A	N/A	N/A	DI2_STATUS	DI2_FLAG	DI1_STATUS	DI1_FLAG

✓ Each bits shows which status has been trigger on this uplink.

Example:

00000111: Means both DI1 and DI2 trigger are enabled and this packet is trigger by DI1.

00000101: Means both DI1 and DI2 trigger are enabled.

Enable/Disable MOD6 : 0x01: MOD6 is enable. 0x00: MOD6 is disable.

Downlink command to poll MOD6 status:

AB 06

When device got this command, it will send the MOD6 payload.

3.3.7 Payload Decoder

Decoder for TTN/Ioraserver/ChirpStack:

http://www.dragino.com/downloads/index.php?dir=LT_LoRa_IO_Controller/LT33222-L/Payload_decoder/

3.4 Configure LT via AT or Downlink

User can configure LT I/O Controller via AT Commands or LoRaWAN Downlink Commands

There are two kinds of Commands:

- ✓ **Common Commands:** They should be available for each sensor, such as: change uplink interval, reset device. For firmware v1.5.4, user can find what common commands it supports:
http://wiki.dragino.com/index.php?title=End_Device_AT_Commands_and_Downlink_Commands
- ✓ **Sensor Related Commands:** These commands are special designed for LT-22222-L. User can see these commands below:

3.4.1 Common Commands:

They should be available for each of Dragino Sensors, such as: change uplink interval, reset device. For firmware v1.5.4, user can find what common commands it supports:

http://wiki.dragino.com/index.php?title=End_Device_AT_Commands_and_Downlink_Commands

3.4.2 Sensor related commands:

Set Transmit Interval

Set device uplink interval.

- AT Command:

AT+TDC=N

Example: AT+TDC=30000. Means set interval to 30 seconds

- Downlink Payload (prefix 0x01):

0x01 aa bb cc // Same as AT+TDC=0x(aa bb cc)

Set Work Mode (AT+MOD)

Set work mode.

- AT Command:

AT+MOD=N

Example: AT+MOD=2. Set work mode to Double DI counting mode

- Downlink Payload (prefix 0x0A):

0x0A aa // Same as AT+MOD=aa

Poll an uplink

- AT Command:

There is no AT Command to poll uplink

- Downlink Payload (prefix 0x08):

0x08 FF // Poll an uplink,

Example: 0x08FF, ask device to send an Uplink

Enable Trigger Mode

Use of trigger mode, please check [ADDMOD6](#)

- AT Command:

AT+ADDMOD6=1 or 0

1: Enable Trigger Mode

0: Disable Trigger Mode

- Downlink Payload (prefix 0x0A 06):

0x0A 06 aa // Same as AT+ADDMOD6=aa,

Poll trigger settings

Poll trigger settings,

- AT Command:

There is no AT Command for this feature.

- Downlink Payload (prefix 0x AB 06):

0xAB 06 // Poll trigger settings, device will uplink [trigger settings](#) once receive this command

Enable / Disable DI1/DI2/DI3 as trigger

Enable Disable DI1/DI2/DI2 as trigger,

- AT Command:

Format: AT+DTRI=<DI1_TIRGGER_FIAG>,< DI2_TIRGGER_FIAG >

Example:

AT+ DTRI =1,0 (Enable DI1 trigger / disable DI2 trigger)

- Downlink Payload (prefix 0xAA 02):

0xAA 02 aa bb // Same as AT+DTRI=aa,bb

Trigger1 – Set DI1 or DI3 as trigger

Set DI1 or DI3(for LT-33222-L) trigger.

➤ AT Command:

AT+TRIG1=a,b

a : Interrupt mode. 0: falling edge; 1: rising edge, 2: falling and raising edge(for MOD=1).

b : delay timing.

Example:

```
AT+TRIG1=1,100(set DI1 port to trigger on high level, valid signal is 100ms )
```

➤ Downlink Payload (prefix 0x09 01):

0x09 01 aa bb cc // same as AT+TRIG1=aa,0x(bb cc)

Trigger2 – Set DI2 as trigger

Set DI2 trigger.

➤ AT Command:

AT+TRIG2=a,b

a : Interrupt mode. 0: falling edge; 1: rising edge, 2: falling and raising edge(for MOD=1).

b : delay timing.

Example:

```
AT+TRIG2=0,100(set DI1 port to trigger on low level, valid signal is 100ms )
```

➤ Downlink Payload (prefix 0x09 02):

0x09 02 aa bb cc // same as AT+TRIG1=aa,0x(bb cc)

Trigger – Set AC (current) as trigger

Set current trigger , base on AC port. See [trigger mode](#)

➤ AT Command:

AT+ACLIM. See [trigger mode](#)

➤ Downlink Payload (prefix 0xAA 01):

0x AA 01 aa bb cc dd ee ff gg hh // same as AT+ACLIM See [trigger mode](#)

Trigger – Set AV (voltage) as trigger

Set current trigger , base on AV port. See [trigger mode](#)

➤ AT Command:

AT+AVLIM. See [trigger mode](#)

➤ Downlink Payload (prefix 0xAA 00):

0x AA 00 aa bb cc dd ee ff gg hh // same as AT+AVLIM See [trigger mode](#)

Trigger – Set minimum interval

Set AV and AC trigger minimum interval, system won't response to the second trigger within this set time after the first trigger.

➤ AT Command:

AT+ATDC=5. Device won't response the second trigger within 5 minute after the first trigger.

➤ Downlink Payload (prefix 0xAC):

0x AC aa bb // same as AT+ATDC=0x(aa bb) . Unit (min)

DO -- Control Digital Output DO1/DO2/DO3

➤ AT Command:

There is no AT Command to control Digital Output

➤ Downlink Payload (prefix 0x02):

0x02 aa bb cc // Set DO1/DO2/DO3 output

If payload = 0x02010001, while there is load between V+ and DOx, it means set DO1 to low, DO2 to high and DO3 to low.

01: Low, 00: High, 11: No action

Downlink Code	DO1	DO2	DO3
02 01 00 11	Low	High	No Action
02 00 11 01	High	No Action	Low
02 11 01 00	No Action	Low	High

Note: For LT-22222-L, there is no DO3, the last byte can use any value.

Device will upload a packet if downlink code executes successfully.

DO -- Control Digital Output DO1/DO2/DO3 with time control

➤ AT Command:

There is no AT Command to control Digital Output

➤ Downlink Payload (prefix 0xA9):

0xA9 aa bb cc // Set DO1/DO2/DO3 output with time control

This is to control the digital output time of DO pin. Include four bytes:

First Byte: Type code (0xA9)

Second Byte: Inverter Mode

01: DO pins will change back to original state after timeout.

00: DO pins will change to an inverter state after timeout

Third Byte: Control Method and Ports status:

Second Byte	Status
0x01	DO1 set to low
0x00	DO1 set to high
0x11	DO1 NO Action

Fourth Byte: Control Method and Ports status:

Second Byte	Status
0x01	DO2 set to low
0x00	DO2 set to high
0x11	DO2 NO Action

Fifth Byte: Control Method and Ports status:

Second Byte	Status
0x01	DO3 set to low
0x00	DO3 set to high
0x11	DO3 NO Action

Sixth and Seventh Byte:

Latching time. Unit: ms

Device will upload a packet if downlink code executes successfully.

Example payload:

a) A9 01 01 01 01 07 D0

DO1 pin & DO2 pin & DO3 pin will be set to Low, last 2 seconds, then change back to original state.

b) A9 01 00 01 11 07 D0

DO1 pin set high, DO2 pin set low, DO3 pin no action, last 2 seconds, then change back to original state.

c) A9 00 00 00 00 07 D0

DO1 pin & DO2 pin & DO3 pin will be set to high, last 2 seconds, then both change to low.

d) A9 00 11 01 00 07 D0

DO1 pin no action, DO2 pin set low, DO3 pin set high, last 2 seconds, then DO1 pin no action, DO2 pin set high, DO3 pin set low

Relay -- Control Relay Output RO1/RO2

➤ AT Command:

There is no AT Command to control Relay Output

➤ Downlink Payload (prefix 0x03):

0x03 aa bb // Set RO1/RO2 output

If payload = 0x030100, it means set RO1 to close and RO2 to open.

01: Close , 00: Open , 11: No action

Downlink Code	RO1	RO2
03 00 11	Open	No Action
03 01 11	Close	No Action
03 11 00	No Action	Open
03 11 01	No Action	Close
03 00 00	Open	Open
03 01 01	Close	Close
03 01 00	Close	Open
03 00 01	Open	Close

Device will upload a packet if downlink code executes successfully.

Relay -- Control Relay Output RO1/RO2 with time control

➤ AT Command:

There is no AT Command to control Relay Output

➤ Downlink Payload (prefix 0x05):

0x05 aa bb cc dd // Set RO1/RO2 relay with time control:

This is to control the relay output time of relay. Include four bytes:

First Byte: Type code (0x05)

Second Byte(aa): Inverter Mode

01: Relays will change back to original state after timeout.

00: Relays will change to an inverter state after timeout

Third Byte(bb): Control Method and Ports status:

Value	Status
0x11	RO1 and RO2 to NO
0x10	RO2 to NO, RO1 to NC
0x01	RO2 to NC, RO1 to NO
0x00	RO1 and RO2 to NC.
0x20	RO1 No Action, RO2 to NC
0x21	RO1 No Action, RO2 to NO
0x02	RO1 to NC, RO2 No Action
0x12	RO1 to NO, RO2 No Action

Fourth / Fifth Bytes (cc): Latching time. Unit: ms

Device will upload a packet if downlink code executes successfully.

Example payload:

e) 05 01 11 07 D0

Relay1 and Relay 2 will be set to NO , last 2 seconds, then change back to original state.

f) 05 01 10 07 D0

Relay1 will change to NO, Relay2 will change to NC, last 2 seconds, then both change back to original state.

g) 05 00 01 07 D0

Relay1 will change to NC, Relay2 will change to NO, last 2 seconds, then relay change to NO, Relay2 change to NC.

h) 05 00 00 07 D0

Relay 1 & relay2 will change to NC, last 2 seconds, then both change to NO.

Counting -- Voltage threshold counting

When voltage exceed the threshold, count. Feature see [MOD4](#)

➤ AT Command:

AT+VOLMAX // See [MOD4](#)

➤ Downlink Payload (prefix 0xA5):

0xA5 aa bb cc // Same as AT+VOLMAX=(aa bb),cc

Counting -- Pre-configure the Count Number

➤ AT Command:

AT+SETCNT=aa,(bb cc dd ee)

aa: 1: Set count1,

2: Set count2,

3: Set AV1 count

Bb cc dd ee: number to be set

➤ Downlink Payload (prefix 0xA8):

0x A8 aa bb cc dd ee // same as AT+SETCNT=aa,(bb cc dd ee)

Counting -- Clear Counting

Clear counting for counting mode

➤ AT Command:

AT+CLRCOUNT // clear all counting

➤ Downlink Payload (prefix 0xA6):

0x A6 01 // clear all counting,

Counting -- Change counting mode save time

➤ AT Command:

AT+COUTIME=60 // Set save time to 60 seconds. Device will save the counting result in internal flash every 60 seconds. (min value: 30)

➤ Downlink Payload (prefix 0xA7):

0x A7 aa bb cc // same as AT+COUTIME =aa bb cc,
range: aa bb cc:0 to 16777215, (unit:second)

3.5 Integrate with Mydevice

Mydevices provides a human friendly interface to show the sensor data, once we have data in TTN, we can use Mydevices to connect to TTN and see the data in Mydevices. Below are the steps:

Step 1: Be sure that your device is programmed and properly connected to the network at this time.

Step 2: To configure the Application to forward data to Mydevices you will need to add integration. To add the Mydevices integration, perform the following steps:

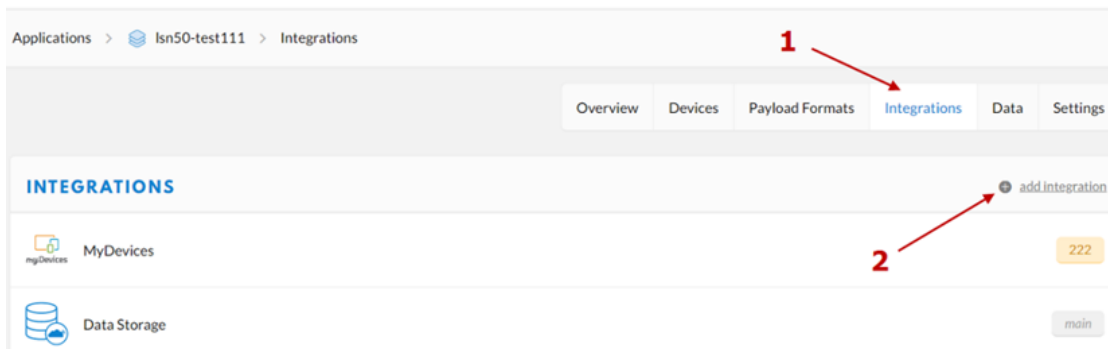

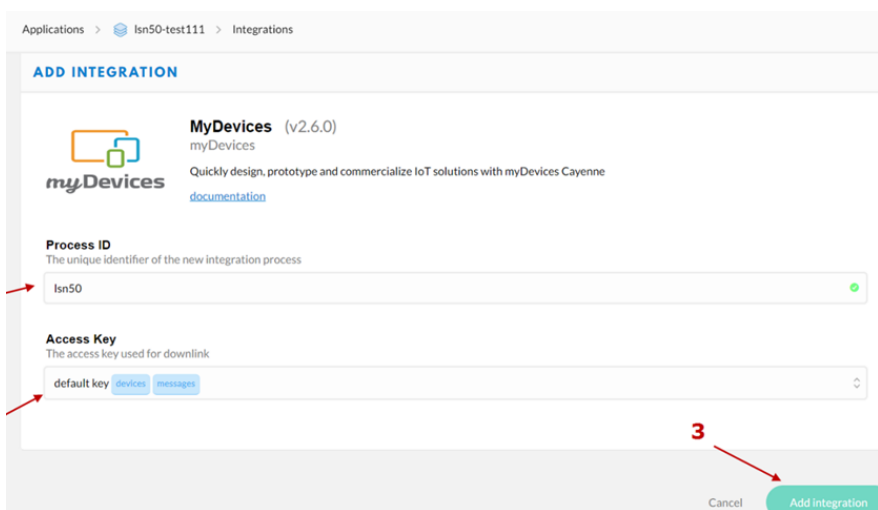
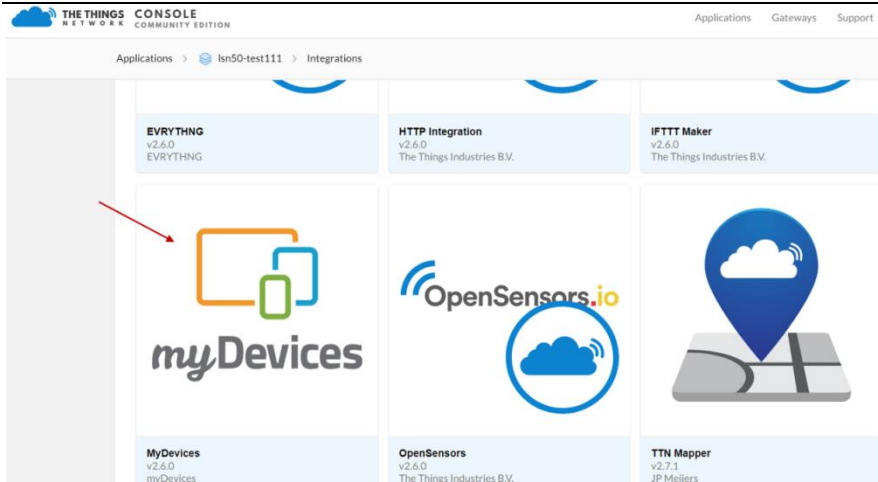

Step 3: Create an account or log in Mydevices.

Step 4: Search LT-2222-L(for both LT-2222-L / LT-3322-L) and add DevEUI.

Search under The things network

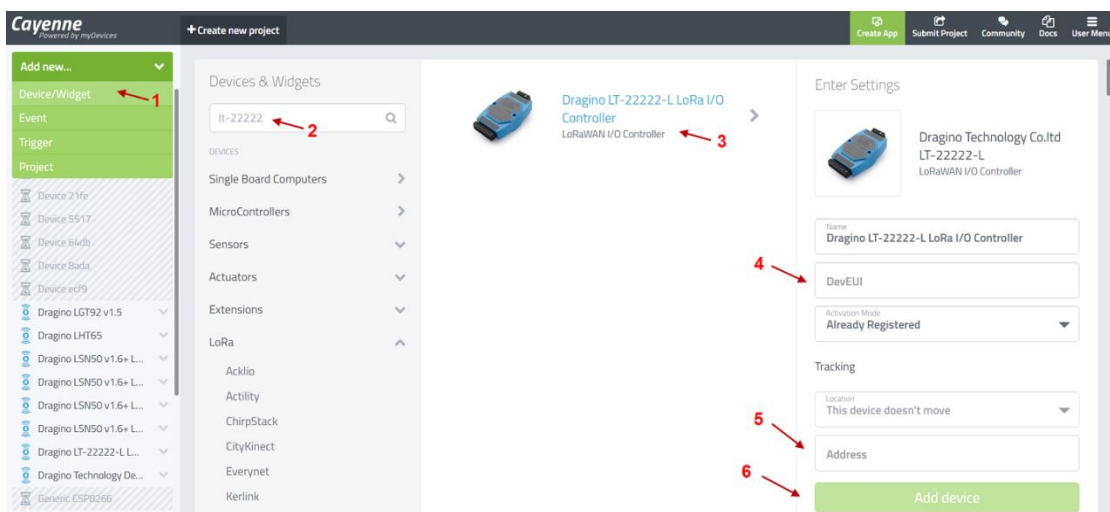

After added, the sensor data arrive TTN, it will also arrive and show in Mydevices.

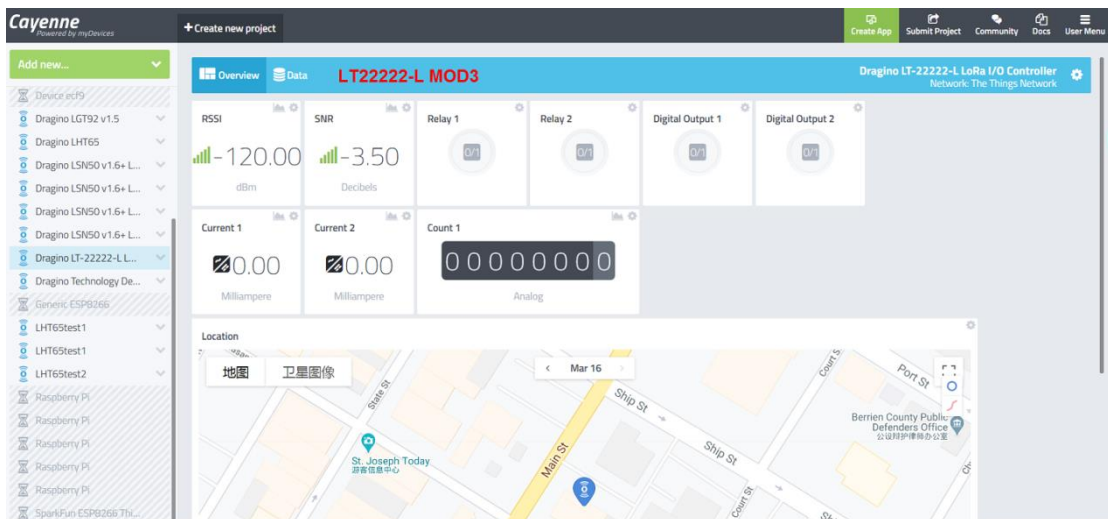
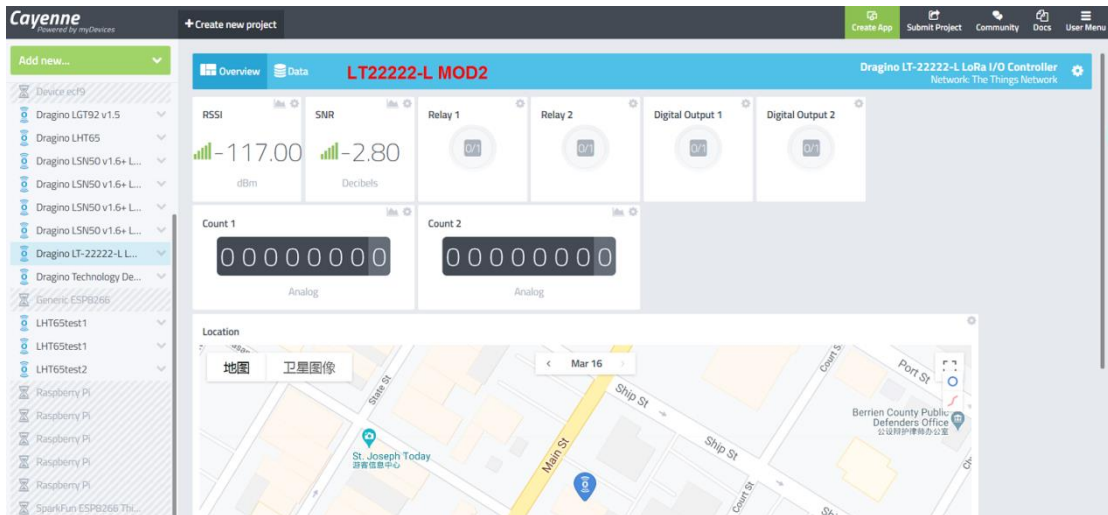
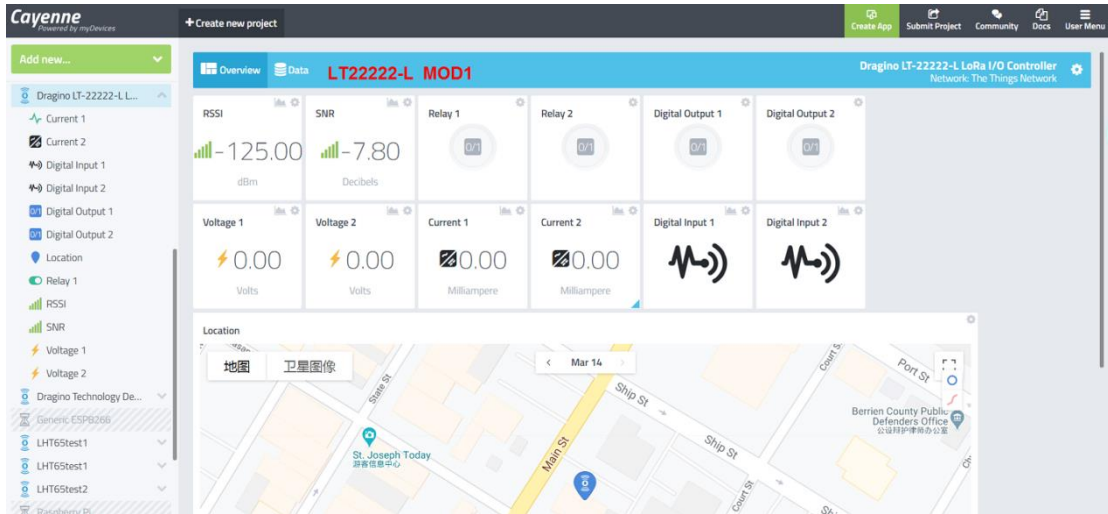

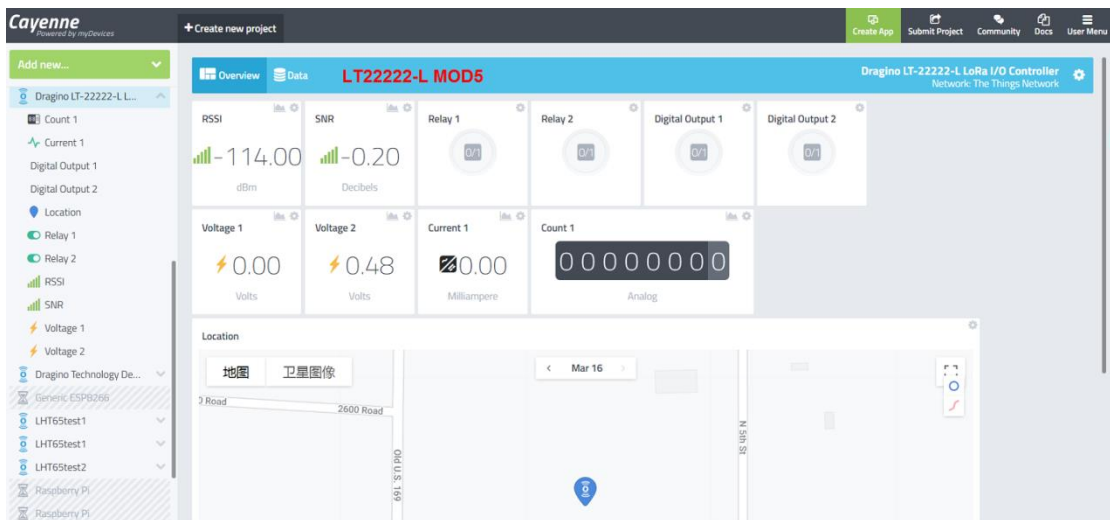
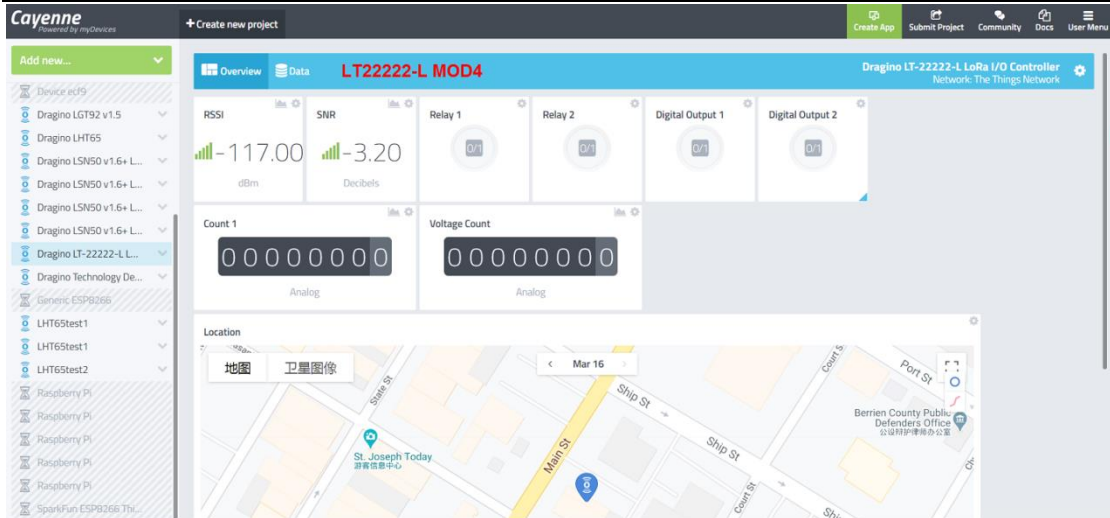

3.6 Interface Detail

3.6.1 Digital Input Port: DI1/DI2 /DI3 (For LT-33222-L, low active)

Support NPN Type sensor

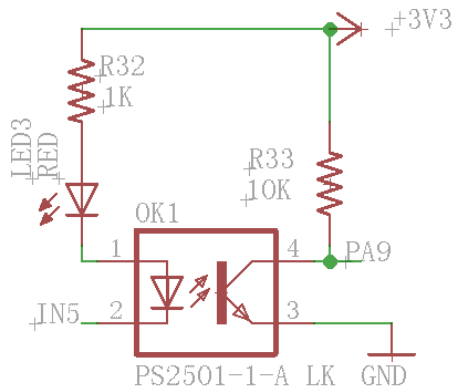

3.6.2 Digital Input Port: DI1/DI2 (For LT-22222-L)

The DI port of LT-22222-L can support NPN or PNP output sensor.

Internal circuit as below, the NEC2501 is a photocoupler, the Active current (from NEC2501 pin 1 to pin 2 is 1ma and the max current is 50mA. When there is active current pass NEC2501 pin1 to pin2. The DI will be active high

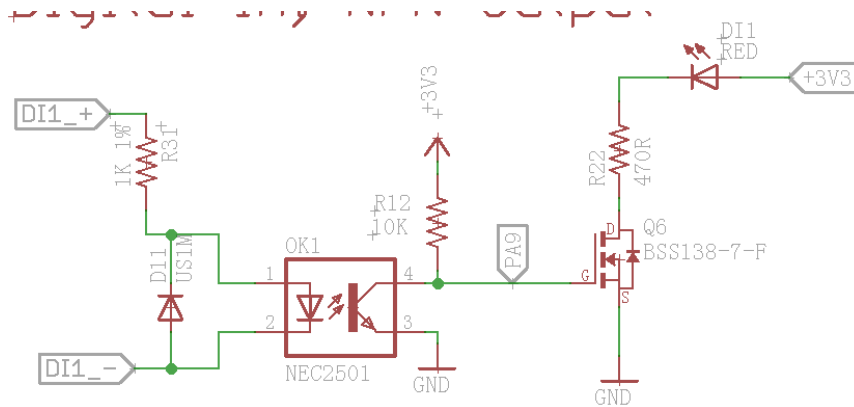

When use need to connect a device to the DI port, both DI1+ and DI1- must be connected.

Example1: Connect to a Low active sensor.

This type of sensor will output a low signal GND when active.

- ✓ Connect sensor's output to DI1-
- ✓ Connect sensor's VCC to DI1+.

So when sensor active, the current between NEC2501 pin1 and pin2 is:

$$I_F = DI1+ / 1K.$$

If DI1+ = 12v, the $I_F = 12mA$, So the LT-22222-L will be able to detect this active signal.

Example2: Connect to a High active sensor.

This type of sensor will output a high signal (example 24v) when active.

- ✓ Connect sensor's output to DI1+
- ✓ Connect sensor's GND DI1-.

So when sensor active, the current between NEC2501 pin1 and pin2 is:

$$I_F = DI1+ / 1K.$$

If DI1+ = 24v, the $I_F = 24mA$, So the LT-22222-L will be able to detect this high active signal.

Example3: Connect to a 220v high active sensor.公司测试一下

Assume user want to monitor an active signal higher than 220v, to make sure not burn the photocoupler

- ✓ Connect sensor's output to DI1+ with a serial 50K resistor
- ✓ Connect sensor's GND DI1-.

So when sensor active, the current between NEC2501 pin1 and pin2 is:

$$I_F = DI1+ / 51K.$$

If sensor output is 220v, the $I_F = 4.3mA$, So the LT-22222-L will be able to detect this high active signal safely.

3.6.3 Digital Output Port: DO1/DO2 /DO3

NPN output: GND or Float. Max voltage can apply to output pin is 36v.

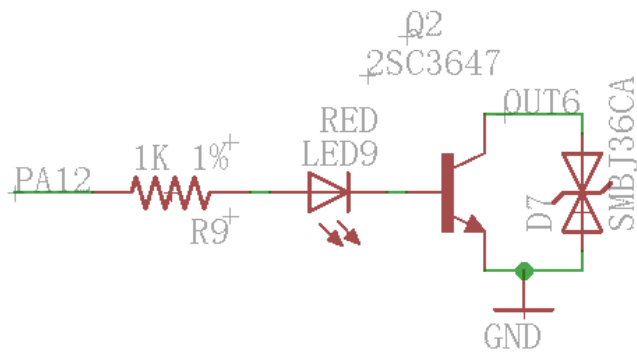

3.6.4 Analog Input Interface

The analog input interface is as below. The LT will measure the IN2 voltage so to calculate the current pass the Load. The formula is:

$$AC2 = (IN2 \text{ voltage}) / 12$$

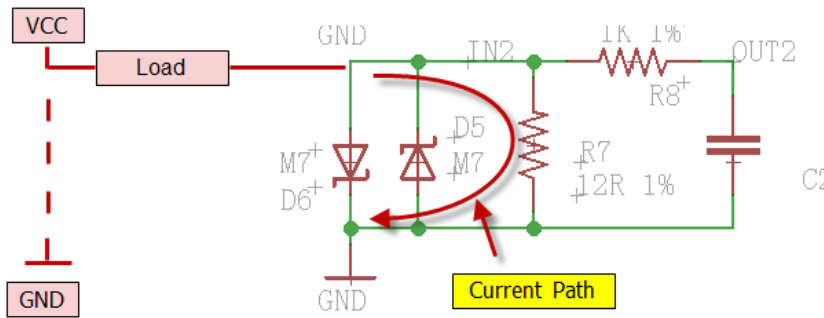

Example to connect a 4~20mA sensor

We take the wind speed sensor as an example for reference only.

Specifications of the wind speed sensor:

Red:12~24v

Yellow:4~20mA

Black:GND

Connection diagram:

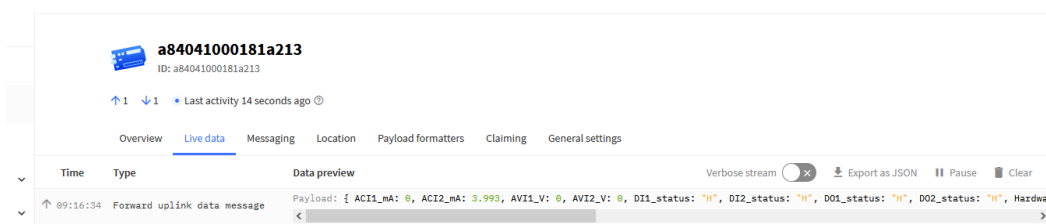

3.6.5 Relay Output

The LT serial controller has two relay interfaces; each interface uses two pins of the screw terminal. User can connect other device's Power Line to in serial of RO1_1 and RO2_2. Such as below:

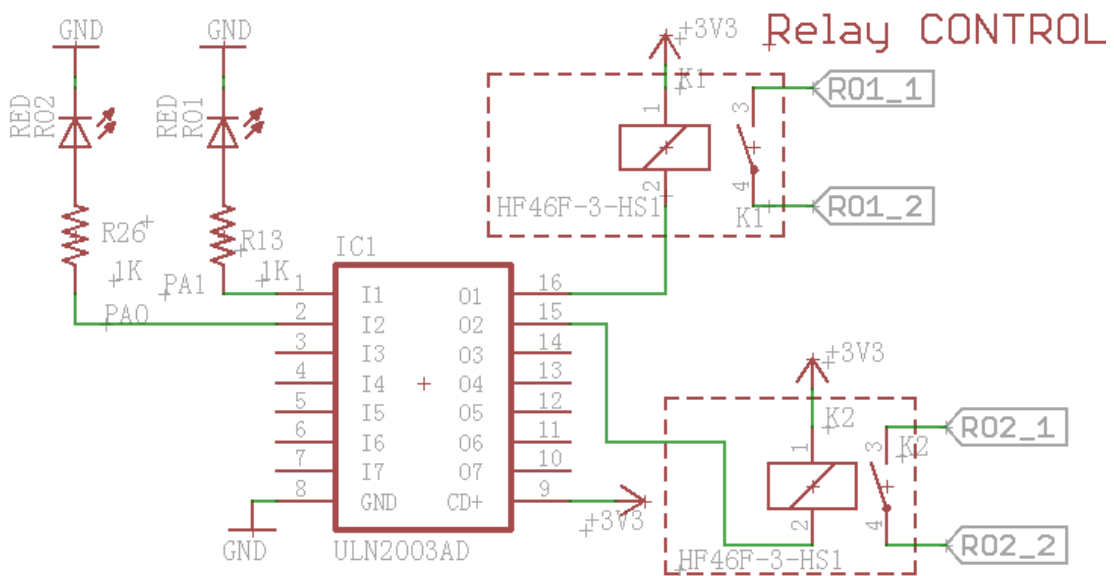
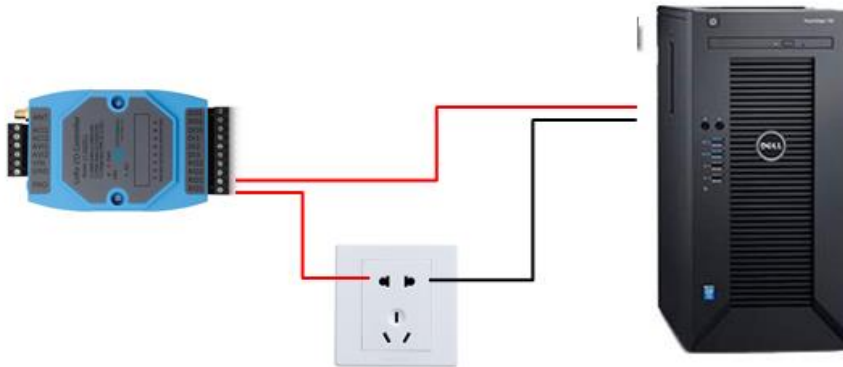

3.7 LEDs Indicators

LEDs	Feature
PWR	Always on if there is power
SYS	After device is powered on, the SYS will fast blink in GREEN for 5 times, means RS485-LN start to join LoRaWAN network. If join success, SYS will be on GREEN for 5 seconds . SYS will blink Blue on every upload and blink Green once receive a downlink message.
TX	Device boot: TX blinks 5 times. Successful join network: TX ON for 5 seconds. Transmit a LoRa packet: TX blinks once
RX	RX blinks once when receive a packet.
DO1	
DO2	
DO3	
DI2	For LT-22222-L: ON when DI2 is high, LOW when DI2 is low For LT-33222-L: ON when DI2 is low, LOW when DI2 is high
DI2	For LT-22222-L: ON when DI2 is high, LOW when DI2 is low For LT-33222-L: ON when DI2 is low, LOW when DI2 is high
DI3	For LT-33222-L ONLY: ON when DI3 is low, LOW when DI3 is high
DI2	For LT-22222-L: ON when DI2 is high, LOW when DI2 is low For LT-33222-L: ON when DI2 is low, LOW when DI2 is high
RO1	
RO2	

4. Use AT Command

4.1 Access AT Command

LT supports AT Command set. User can use a USB to TTL adapter plus the 3.5mm Program Cable to connect to LT for using AT command, as below.

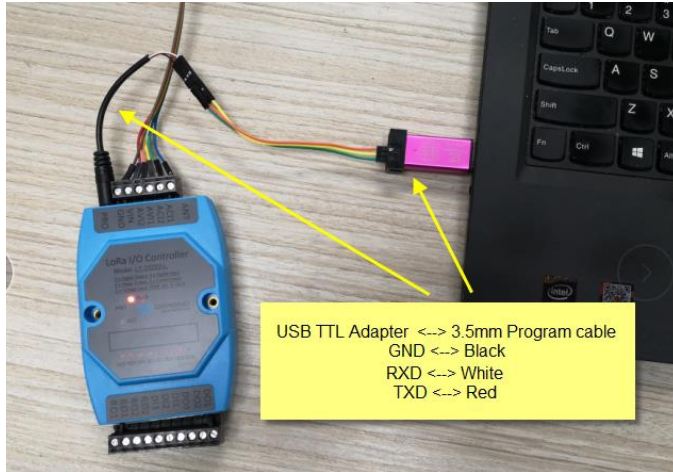

In PC, User needs to set **serial tool**(such as [putty](#), SecureCRT) baud rate to **9600** to access to access serial console for LT. The AT commands are disable by default and need to enter password (default:**123456**) to active it. As shown below:

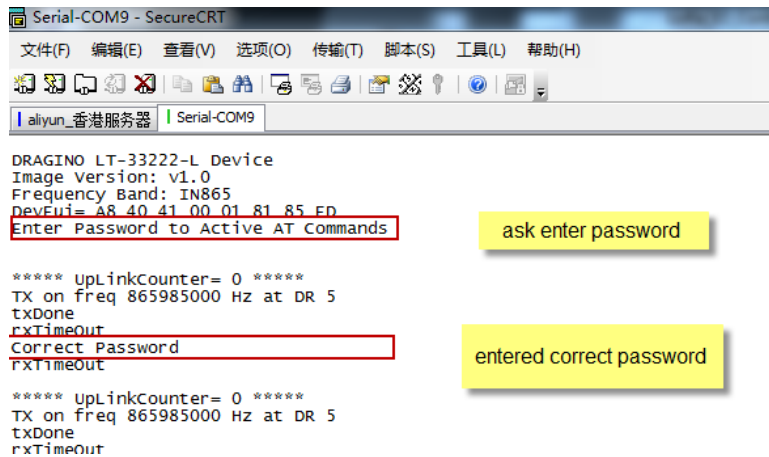

More detail AT Command manual can be found at [AT Command Manual](#)

- AT+<CMD>? : Help on <CMD>
- AT+<CMD> : Run <CMD>
- AT+<CMD>=<value> : Set the value
- AT+<CMD>=? : Get the value
- ATZ: Trig a reset of the MCU
- AT+FDR: Reset Parameters to Factory Default, Keys Reserve
- AT+DEUI: Get or Set the Device EUI
- AT+DADDR: Get or Set the Device Address
- AT+APPKEY: Get or Set the Application Key
- AT+NWKSKEY: Get or Set the Network Session Key

AT+APPSKEY: Get or Set the Application Session Key

AT+APPEUI: Get or Set the Application EUI

AT+ADR: Get or Set the Adaptive Data Rate setting. (0: off, 1: on)

AT+TXP: Get or Set the Transmit Power (0-5, MAX:0, MIN:5, according to LoRaWAN Spec)

AT+DR: Get or Set the Data Rate. (0-7 corresponding to DR_X)

AT+DCS: Get or Set the ETSI Duty Cycle setting - 0=disable, 1=enable - Only for testing

AT+PNM: Get or Set the public network mode. (0: off, 1: on)

AT+RX2FQ: Get or Set the Rx2 window frequency

AT+RX2DR: Get or Set the Rx2 window data rate (0-7 corresponding to DR_X)

AT+RX1DL: Get or Set the delay between the end of the Tx and the Rx Window 1 in ms

AT+RX2DL: Get or Set the delay between the end of the Tx and the Rx Window 2 in ms

AT+JN1DL: Get or Set the Join Accept Delay between the end of the Tx and the Join Rx Window 1 in ms

AT+JN2DL: Get or Set the Join Accept Delay between the end of the Tx and the Join Rx Window 2 in ms

AT+NJM: Get or Set the Network Join Mode. (0: ABP, 1: OTAA)

AT+NWKID: Get or Set the Network ID

AT+FCU: Get or Set the Frame Counter Uplink

AT+FCD: Get or Set the Frame Counter Downlink

AT+CLASS: Get or Set the Device Class

AT+JOIN: Join network

AT+NJS: Get OTAA Join Status

AT+SENDB: Send hexadecimal data along with the application port

AT+SEND: Send text data along with the application port

AT+RECVB: Print last received data in binary format (with hexadecimal values)

AT+RECV: Print last received data in raw format

AT+VER: Get current image version and Frequency Band

AT+CFM: Get or Set the confirmation mode (0-1)

AT+CFS: Get confirmation status of the last AT+SEND (0-1)

AT+SNR: Get the SNR of the last received packet

AT+RSSI: Get the RSSI of the last received packet

AT+TDC: Get or set the application data transmission interval in ms

AT+PORT: Get or set the application port

AT+DISAT: Disable AT commands

AT+PASSWORD: Set password, max 9 digits

AT+CHS: Get or Set Frequency (Unit: Hz) for Single Channel Mode

AT+CHE: Get or Set eight channels mode, Only for US915, AU915, CN470

AT+CFG: Print all settings

4.2 Common AT Command Sequence

4.2.1 Multi-channel ABP mode (Use with SX1301/LG308)

If device has not joined network yet:

```
123456
AT+FDR
123456
AT+NJM=0
ATZ
```

If device already joined network:

```
AT+NJM=0
ATZ
```

4.2.2 Single-channel ABP mode (Use with LG01/LG02)

```
123456 Enter Password to have AT access.
AT+FDR Reset Parameters to Factory Default, Keys Reserve
123456 Enter Password to have AT access.
AT+CLASS=C Set to work in CLASS C
AT+NJM=0 Set to ABP mode
AT+ADR=0 Set the Adaptive Data Rate Off
AT+DR=5 Set Data Rate
AT+TDC=60000 Set transmit interval to 60 seconds
AT+CHS=868400000 Set transmit frequency to 868.4Mhz
AT+RX2FQ=868400000 Set RX2Frequency to 868.4Mhz (according to the result from server)
AT+RX2DR=5 Set RX2DR to match the downlink DR from server. see below
AT+DADDR=26 01 1A F1 Set Device Address to 26 01 1A F1, this ID can be found in the LoRa
Server portal.
ATZ Reset MCU
```

Note:

1. Make sure the device is set to ABP mode in the IoT Server.
2. Make sure the LG01/02 gateway RX frequency is exactly the same as AT+CHS setting.
3. Make sure SF / bandwidth setting in LG01/LG02 match the settings of AT+DR. refer [this link](#) to see what DR means.
4. The command AT+RX2FQ and AT+RX2DR is to let downlink work. to set the correct parameters, user can check the actually downlink parameters to be used. As below. Which shows the RX2FQ should use 868400000 and RX2DR should be 5

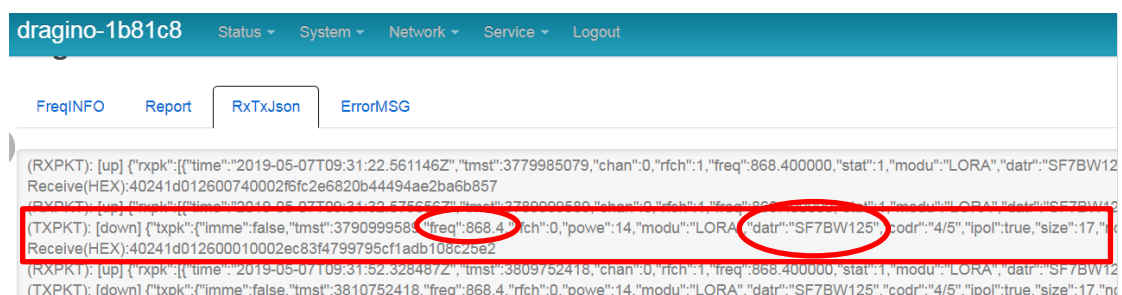

4.2.3 Change to Class A

If sensor JOINED

AT+CLASS=A

ATZ

5. FAQ

5.1 How to upgrade the image?

The LT LoRaWAN Controller is shipped with a 3.5mm cable, the cable is used to upload image to LT to:

- ✓ Support new features
- ✓ For bug fix
- ✓ Change LoRaWAN bands.

Below shows the hardware connection for how to upload an image to the LT:

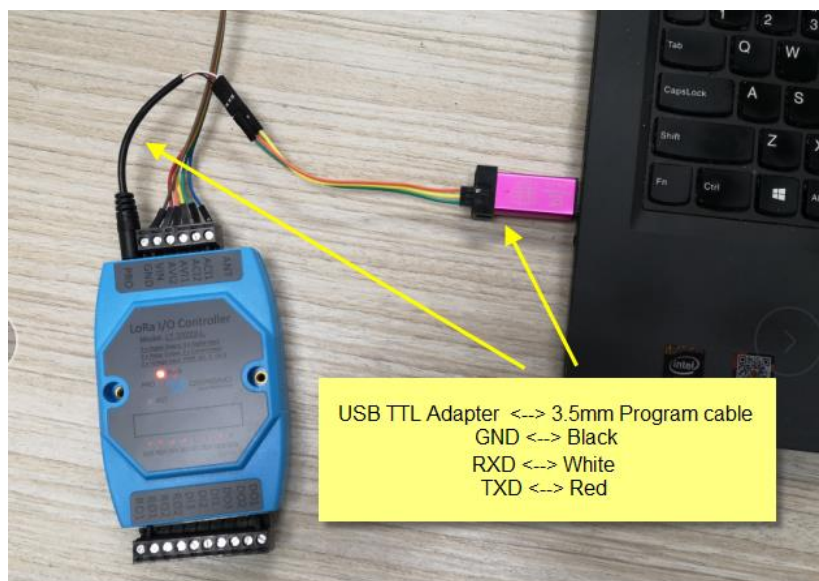

Step1: Download [flash loader](#).

Step2: Download the [LT Image files](#).

Step3: Open flashloader; choose the correct COM port to update.

For LT-33222-L:

Hold down the PRO button and then momentarily press the RST reset button and the **DO2 led** will change from OFF to ON. When **DO2 LED** is on, it means the device is in download mode.

For LT-22222-L:

Hold down the PRO button and then momentarily press the RST reset button and the **DO1 led** will change from OFF to ON. When **DO1 LED** is on, it means the device is in download mode.

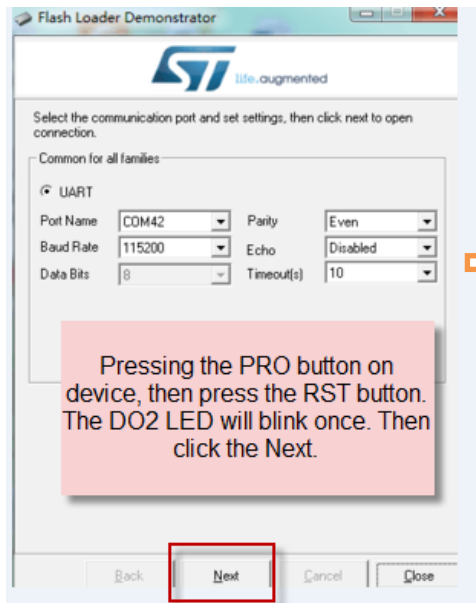

Board detected

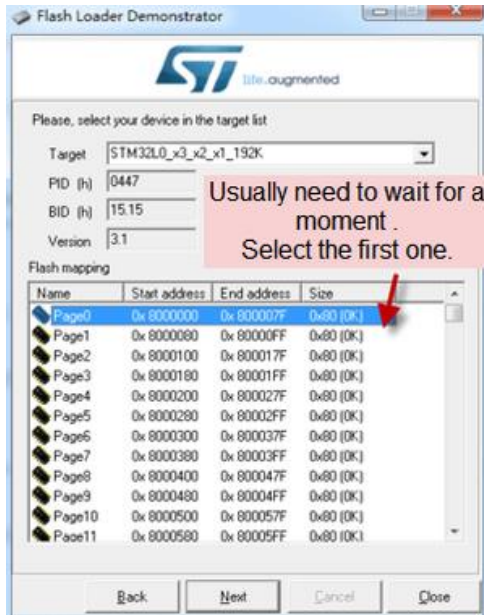
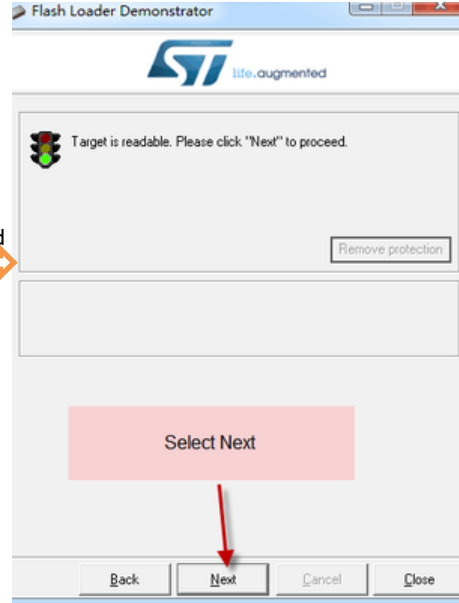

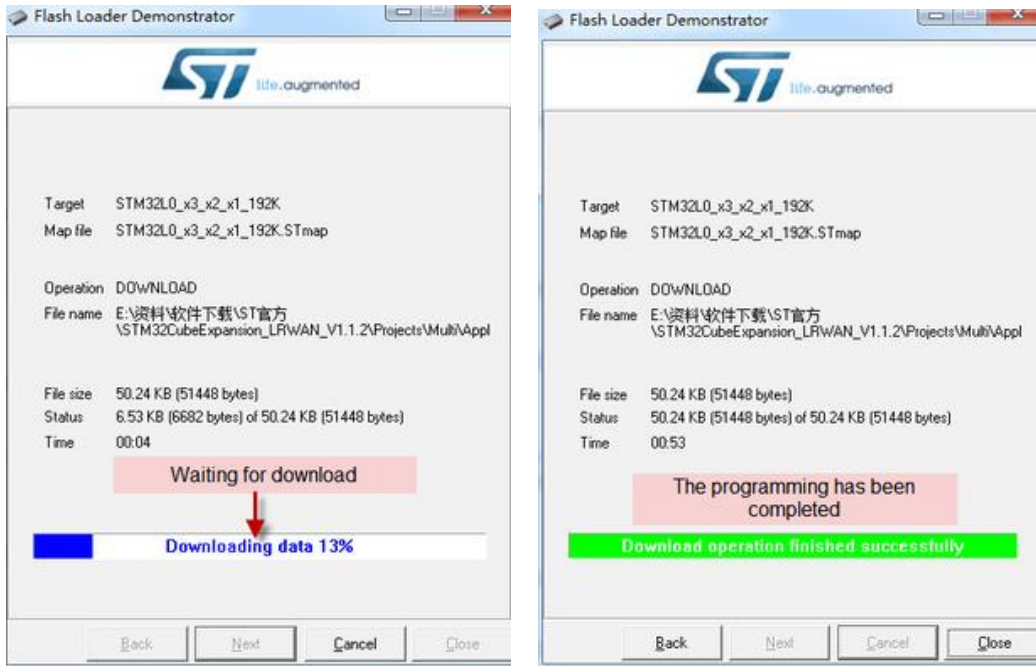

Notice: In case user has lost the program cable. User can hand made one from a 3.5mm cable. The pin mapping is:



5.2 How to change the LoRa Frequency Bands/Region?

User can follow the introduction for [how to upgrade image](#). When download the images, choose the required image file for download.

5.3 How to set up LT to work with Single Channel Gateway such as LG01/LG02?

In this case, users need to set LT-33222-L to work in ABP mode & transmit in only one frequency. Assume we have a LG02 working in the frequency 868400000 now , below is the step.

Step1: Log in TTN, Create an ABP device in the application and input the network session key (NETSKEY), app session key (APPSKEY) from the device.

CONSOLE
COMMUNITY EDITION

Applications Gateways Support

Applications > dragino_test_application1 > Devices > 23232

Application ID **dragino_test_application1**

Device ID 23232

Description LT-33222-L-5645

Activation Method **ABP**

Device EUI <> 00 B9 14 BE 07 0A 90 34

Application EUI <> 70 B3 D5 7E F0 00 46 18

Device Address <> 26 01 1A F1

Network Session Key <> DD 86 97 F6 BD 8E 7F 43 CE 69 44 4F 26 64 16 41

App Session Key <> 78 48 B2 5C D6 BE 8B 2F 8B C8 47 B8 13 21 FE 14

Status ● 4 minutes ago

In ABP mode, The device Address, Network Session Key, App Session Key must match between the End Node and LoRaWAN server

Note: user just need to make sure above three keys match, User can change either in TTN or Device to make them match. In TTN, NETSKEY and APPSKEY can be configured by user in setting page, but Device Addr is generated by TTN.

Step2: Run AT Command to make LT work in Single frequency & ABP mode. Below is the AT commands:

```

123456 Enter Password to have AT access.
AT+FDR Reset Parameters to Factory Default, Keys Reserve
123456 Enter Password to have AT access.
AT+NJM=0 Set to ABP mode
AT+ADR=0 Set the Adaptive Data Rate Off
AT+DR=5 Set Data Rate (Set AT+DR=3 for 915 band)
AT+TDC=60000 Set transmit interval to 60 seconds
AT+CHS=868400000 Set transmit frequency to 868.4Mhz
AT+DADDR=26 01 1A F1 Set Device Address to 26 01 1A F1
ATZ Reset MCU
    
```

As shown in below:

```
***** UpLinkCounter= 0 *****
TX on Freq 865402500 Hz at DR 5
txDone
Correct Password
rxTimeOut
AT+rxTimeOut
FD
***** UpLinkCounter= 0 *****
TX on Freq 865402500 Hz at DR 5
txDone
R
DRAGINO LT-33222-L Device
Image Version: v1.0
Frequency Band: IN865
DevEui= A8 40 41 00 01 81 85 EE
Enter Password to Active AT Commands

Please set the parameters or reset Device to apply change
Correct Password
AT+NM=0
OK
AT+ADR=0
OK
AT+DR=5
OK
AT+TDC=60000
OK
AT+CHS=868400000
OK
AT+DADDR=26 01 1A F1
OK
ATZ
DRAGINO LT-33222-L Device
Image Version: v1.0
Frequency Band: IN865
DevEui= A8 40 41 00 01 81 85 EE
Enter Password to Active AT Commands

JOINED

***** UpLinkCounter= 0 *****
TX on Freq 868400000 Hz at DR 5
txDone
rxTimeOut
rxTimeOut
█
```

5.4 Can I see counting event in Serial?

User can run AT+DEBUG command to see the counting event in serial. If firmware too old and doesn't support AT+DEBUG. User can update to latest firmware first.

6. Trouble Shooting

6.1 Downlink doesn't work, how to solve it?

Please see this link for how to debug:

http://wiki.dragino.com/index.php?title=LoRaWAN_Communication_Debug#How_it_work

6.2 Have trouble to upload image.

See this link for trouble shooting:

http://wiki.dragino.com/index.php?title=Firmware_Upgrade_Trouble_Shooting#UART_upgrade_trouble_shooting

6.3 Why I can't join TTN in US915 /AU915 bands?

It might be about the channels mapping. Please see this link for detail:

http://wiki.dragino.com/index.php?title=LoRaWAN_Communication_Debug#Notice_of_US915.2_FC470.2FAU915_Frequency_band

7. Order Info

For LT-33222-L-XXX or LT-22222-L-XXX:

XXX:

- **EU433**: LT with frequency bands EU433
- **EU868**: LT with frequency bands EU868
- **KR920**: LT with frequency bands KR920
- **CN470**: LT with frequency bands CN470
- **AS923**: LT with frequency bands AS923
- **AU915**: LT with frequency bands AU915
- **US915**: LT with frequency bands US915
- **IN865**: LT with frequency bands IN865
- **CN779**: LT with frequency bands CN779

8. Packing Info

Package Includes:

- ✓ LT I/O Controller x 1
- ✓ Stick Antenna for LoRa RF part x 1
- ✓ Bracket for controller x1
- ✓ Program cable x 1

Dimension and weight:

- ✓ Device Size: 13.5 x 7 x 3 cm

- ✓ Device Weight: 105g
- ✓ Package Size / pcs : 14.5 x 8 x 5 cm
- ✓ Weight / pcs : 170g

9. Support

- Support is provided Monday to Friday, from 09:00 to 18:00 GMT+8. Due to different timezones we cannot offer live support. However, your questions will be answered as soon as possible in the before-mentioned schedule.
- Provide as much information as possible regarding your enquiry (product models, accurately describe your problem and steps to replicate it etc) and send a mail to

support@dragino.com

10. Reference

✧ Product Page:

LT-33222-L: <http://www.dragino.com/products/lora-lorawan-end-node/item/138-lt-33222-l.html>

LT-22222-L: <http://www.dragino.com/products/lora-lorawan-end-node/item/156-lt-22222-l.html>

✧ [Image Download](#)

✧ [AT Command Manual](#)

✧ [Hardware Source](#)