

TCP/IP to RS232/422/485 Converter

User's Manual

Model ATC-1200



1.0 Introduction

The ATC-1200 is a cost effective and highly integrated Serial-to-Ethernet Converter. Embedding a 8-bit pipelined RISC, single cycle per instruction with maximum operating frequency of 100Mhz (100 MIPS), Embed 512KB Flash memory and 32KB SRAM for data memory. 10/100Mbps Ethernet and serial port support handshake RTS, CTS. ATC-1200 Can control 1 x RS232/422/485 devices located virtually anywhere (via Ethernet or Internet). Automatically finds devices in the network Configuration over Driver Panels, serial Port, Telnet, WEB Browser, SNMP Automatic mode switching between Driver and RAW mode Support TCP/IP, UDP, DHCP, Support TCP, UDP, ICMP, IPv4, DHCP, BOOTP, ARP, DNS, SMTP, SNMP, uPNP, and HTTP in software

2.0 Features:

- ◆ 3-in-1 RS-232/422/485 interface Max.921.6Kbps Serial interface and 10/100 Mbps Ethernet
- ◆ Supports 4- and 2-wire RS-422 and built-in terminator
- ◆ Supports industrial 12-24 VDC power input
- ◆ Terminal block accessories for easy RS-422/485 serial wiring
- ◆ Supports IP configuration by web browser
- ◆ Supports configuration store and copy for easy deployment
- ◆ Supports Driver, TCP Server/Client, UDP Server/Client, Pair Connection operation modes
- ◆ Easy and powerful configuration program
- ◆ Approval CE, FCC, RoHS

3.0 . Hardware Installation & Initial Setup

3.1 RS-232 Pinout: (DB9 Male)

(DB9Male)	Signal	I/O
PIN2	RXD	IN
PIN3	TXD	OUT
PIN5	GND	-
PIN7	RTS	OUT
PIN8	CTS	IN

3.2 RS-422/485 Pinout: (Six Terminal from left)

Terminal No	1	2	3	4	5	6
RS-422	R+	R-	T+	T-	VIN	GND
RS-485	485+	485-	-	-	VIN	GND

3.3 Connect to 10/100M Ethernet:

ATC-1200 10/100M Port can connect to switcher or Hub use straight-Through Cable as following diagram.

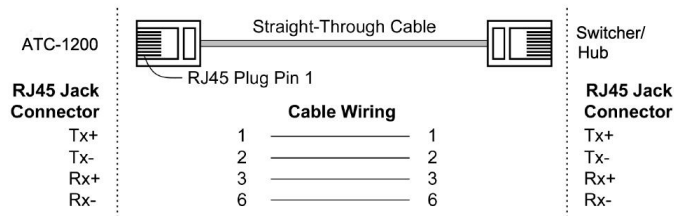

3.4 Power Supply:

ATC-1200 TCP/IP converter can adopt the product's 9V power adapter for power supply or adopt power from other DC power or device. (+9~24VDC@500-100mA).

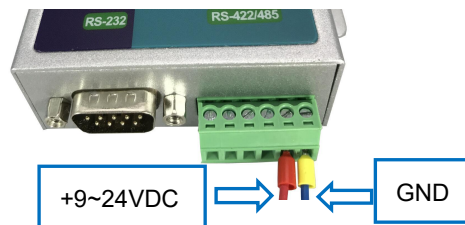

3.5 ATC-1200 LED indication:

- LINK — Indication Ethernet Link, Green on Ethernet Link established.
- TXD — Data Sending from Ethernet to Serial port
- RXD — Receiving data from Serial port to Ethernet
- PWR — Indication Power on

3.6 Connection Diagram

RS-232 Connection

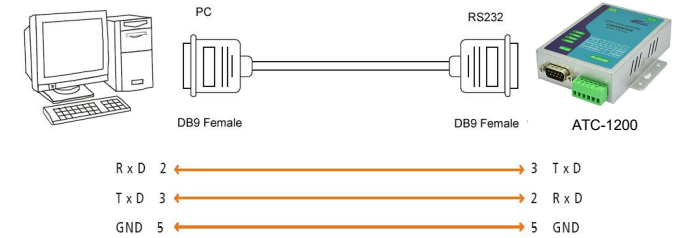

RS-422 Connection

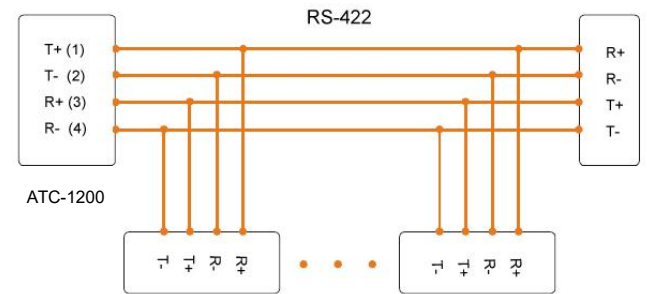

RS-485 Connection

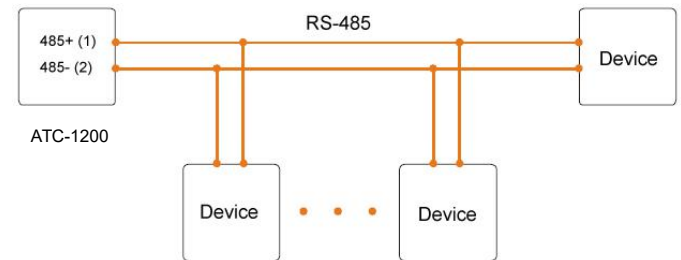

4.0 Configuration and Operation

Use this section to set up your computer to assign it a static IP address in the 192.168.2.2 to 192.168.2.254 range with a subnet mask of 255.255.255.0. This is necessary to ensure that your computer can communicate with your ATC-1200. Your computer must have an Ethernet card and TCP/IP installed. TCP/IP should already be installed on computer using Windows 98/2000/XP/win7/windows 10 and later operating systems.

Step 1: Open your web browser and type <http://192.168.2.125> in the browser's *address box*. This address is the factory set IP Address of your ATC-1200. Press **"Enter"**.

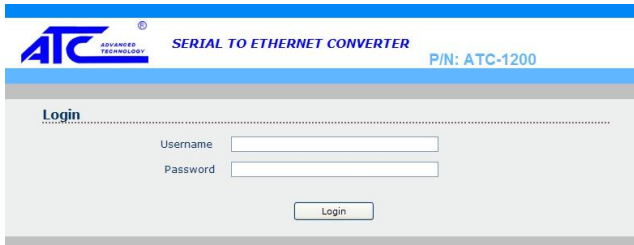

Step 2: The **"Username and Password required"** prompt box will appear. Typing **"admin"** (default username) in the Username field and typing **"admin"** (default password) in the Password field. Click **"OK"**. The setup screen will then appear.



User login to enter Username and password.

Default Username : admin

Default Password : admin

4.1 The menu features as below:



All above the functions explain as below.

4.2 Basic Setup

Manager of the relevant setting page have two main configuration options. Serial setting and Network setting.

4.3 Serial Setting

The ATC-1200 support three serial types: RS232, RS422 and RS485, The user can reference hardware diagram to directly select RS232, RS422, RS485 by software.

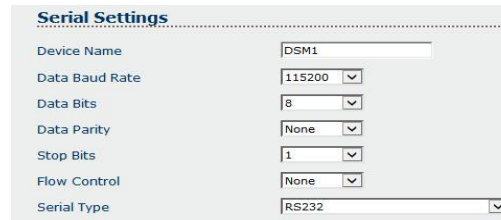

Device Name: DMS1 (default). User's can modify the device name as you expectantly. But the character not more than 15

Data Baud Rate: default 115200, RS-232 range 1200 to 115200 bps

RS-422/485 range 1200 to 921600bps

Data Parity : None (default), even, odd

Data Bits: 5, 6, 7, 8 (default)

Stop Bits: 1 (default), 1.5 or 2

Flow Control: None (default), CTS/RTS (or Hardware)

Serial Type: RS-232 (default), RS485, RS422 (Master), RS422 (Slave)

4.4 Network Setting

The ATC-1200 support two IP connection types: Static IP, DHCP. These types are listed in the Web page for the Networking Setting. Each setup screen and available features will differ depending on what kind of IP connection types you select. Default is **Static IP**

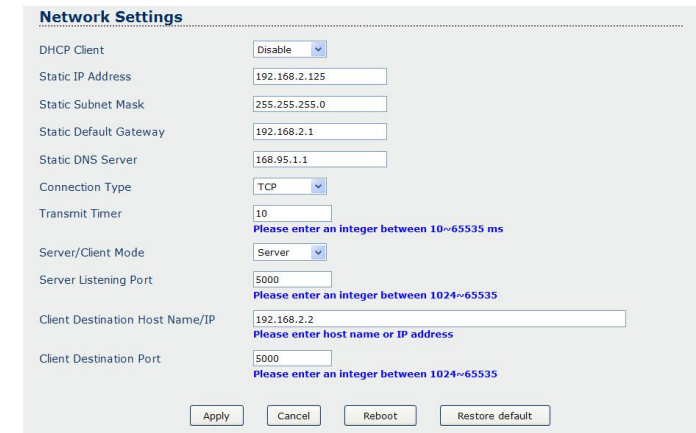

DHCP Client : Disable (default) or Enable

If there is a DHCP Server existing in your network environment or you subscribe a CABLE service from your ISP, you can set IP configuration to DHCP to get a dynamic IP address.

If you choose disable means ATC-1200 will submit static IP mode. You should dispatch one IP address to it.

IP Address: default 192.168.2.125

Subnet mask: default 255.255.255.0

Gateway: default 192.168.2.1

Primary DNS: default 168.95.1.1

If you are connecting through a static or fixed IP from your network environment, perform these steps:

Step 1: Disable DHCP Client

Step 2: Enter IP address

Step 3: Enter Subnet mask

Step 4: Enter Gateway IP address

Step 5: Enter Primary DNS IP address

Step 6: Click Apply and then Reboot button

Connection Type: default **TCP/UDP**

Transmit Timer:10-65535ms Default **10ms**

User's should enter an integer between 10~65535 ms

Server/Client Mode:Server/Client.default **Server**

Server Listening Port:default **5000**

User's should enter an integer between 1024~65535

Client Destination Host Name/IP:

192.168.2.2 default

User's should be enter host name or IP address

5.0 Advance Setting

ATC-1200 advance setting offer some useful function for customer.

Temperature: function allow customer monitor the AT-1200 or device environment.(Notes:This function not effective on standard product.Customer need specific order)

Firmware Upgrade Settings:

This function allow customer to upgrade the firmware by

themselves

E-mail Setting&Auto Warning Report Settings

This function allow user setting some warning message when Someone change ATC-1200 parameter or reach some value.

5.0 Security Setting

This function allow change access ATC-1200 username and password from default setting as user exception.

6.0 Save and restore ATC-1200 default Setting

User need to click **Apply** button save parameter If you make some configuration of ATC-1200. And then click **Reboot** button to make it effect.

We offer two way to restore ATC-1200 to default setting. You can though ATC-1200 basic webpage at bottom to see there have one **Restore Default** button.Then click it. And ATC-1200 will be show message from webpage ask you confirm to restore ATC-1200 to factory default.

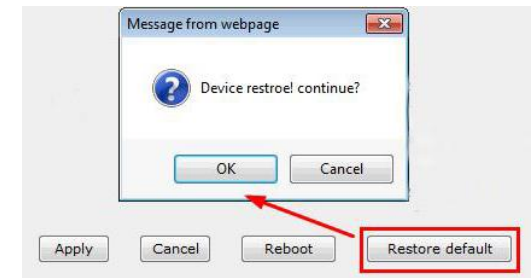

If choose **OK**.The ATC-1200 will be automatic to restart within 15 seconds.We also offer another hardware button to Restore ATC-1200.To find restore button as following photo.

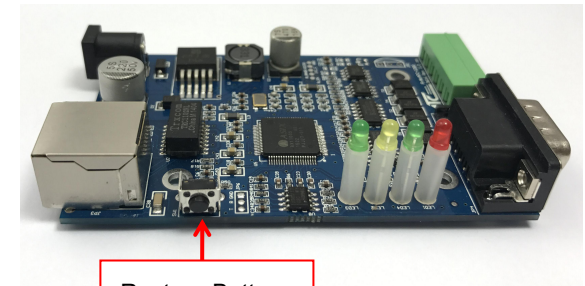

To use tweezers press the button at **5 seconds**. And see the LINK LED will went out and then on. It's mean the restore is success.

7.0 How to make ATC-1200 connect with your device.

The ATC-1200 support four operation mode: TCP Server, TCP Client, UDP Server and UDP Client. These modes are listed in the Web page for the Operation Mode setting. Each setup screen and available features will differ depending on what kind of operation mode you select. Default is **TCP Server**.

7.1 TCP Server

Server Listening Port Number: default **5000**, range **0** to **65535**

If your device is acted as passive to accept commands from remote and the data be guaranteed to be received by peer is your concern, then you can set ATC-1200 as TCP Server. Be sure the value of item **Server Listening Port Number** is same as your remote control application using.

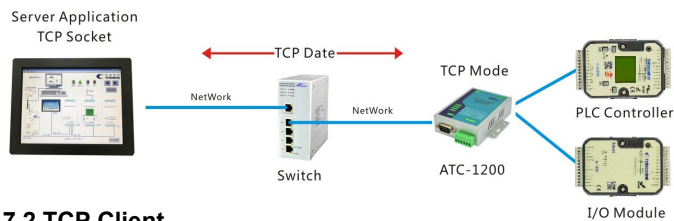

7.2 TCP Client

Client Destination Host name/IP: default **192.168.2.2**

Client Destination Port: default **5000**, range **0** to **65535**

If your device is acted as active to report real-time status to remote and the data be guaranteed to be received by peer is your concern, then you can set ATC-1200 as TCP Client. Be sure the value of item **Client Destination Port** is same as your remote control application using and set the correct value of **Client Destination Host name/IP**.

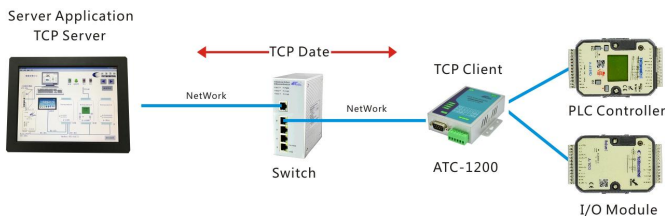

7.3 UDP Server

Server Listening Port Number: default **5000**, range **0** to **65535**

If your device is acted as passive to accept commands from remote and the data be guaranteed to be received by peer is *not* your concern, then you can set ATC-1200 as UDP Server. Be sure the value of item **Server Listening Port Number** is same as your remote control application using.

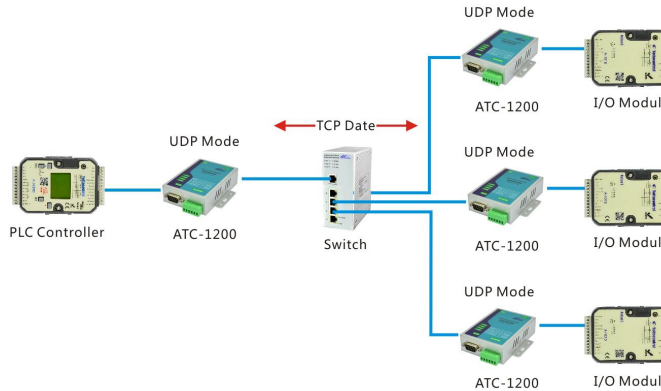

7.4 UDP Client

Client Destination Port Number: default **5000**, range **0** to **65535**

Client Destination Host name/IP: default **192.168.2.2**

If your device is acted as active to report real-time status to remote and the data be guaranteed to be received by peer is *not* your concern, then you can set ATC-1200 as TCP Client. Be sure the value of item **Client Destination Port Number** is same as your remote control application using and set the correct value of **Client Destination Host name/IP**.

7.5 Peer to Peer mode

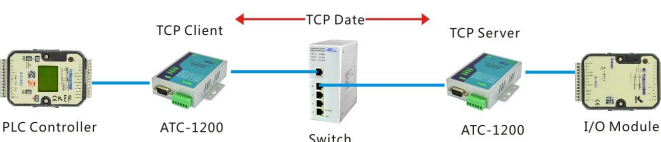

If you want to use peer to peer mode. You should configuration One ATC-1200 as TCP Server Mode and another one as TCP Client Mode.

For Example. Setting as following step.

Step 1: Setting one ATC-1200 TCP Server Mode

IP Address:192.168.2.125

Server Listening Port number: 5000

Step 2: Setting another one ATC-1200 TCP Client Mode:

IP Address: 192.168.2.126

(TCP Server and TCP Client should be use different IP address)

Client Destination Host name/IP: 192.168.2.125(It's

TCP Server IP Address)

Client Destination Port: 5000(It's TCP Server Server Listening Port)

Step 3: Apply and reboot.

Distributed by: