

# 20" 2-in-1 High Velocity Wall Mounted or Floor Fan

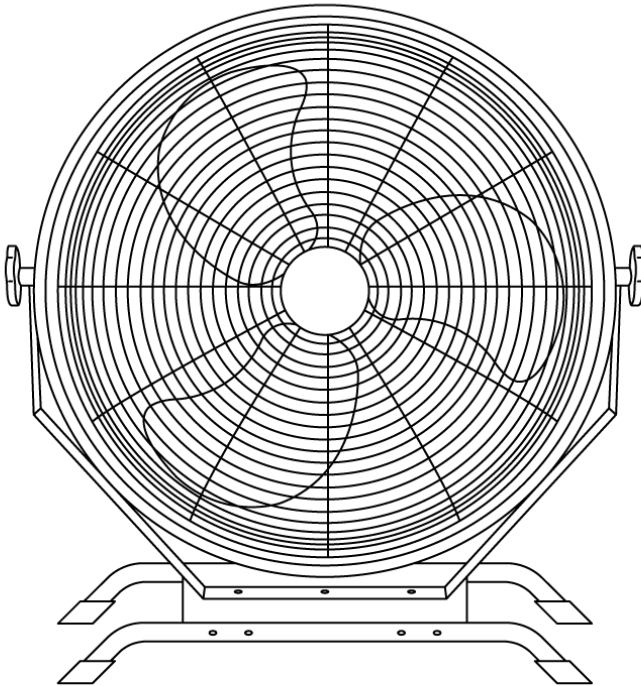

## **OWNER'S MANUAL**

*Read and save these instructions.*



**Intertek**  
Manual v1.0

---

# READ AND SAVE THESE INSTRUCTIONS.

---

## TABLE OF CONTENTS

Register Your Product Online.....	3
Safety Information & Warnings .....	4
Assembly Instructions.....	7
Operation Instructions.....	9
Cleaning & Maintenance.....	10
Troubleshooting.....	12
Limited Manufacturer's Warranty .....	13

---

## PRODUCT SPECIFICATIONS

<b>MODEL NO.</b>	NIF20CBK00
<b>VOLTAGE:</b>	120V/60Hz
<b>AMPS(LOW/MED/HIGH):</b>	0.864A/0.918A/0.948A
<b>WATTS(LOW/MED/HIGH):</b>	100W/110W/120W
<b>CERTIFICATION:</b>	CETL
<b>OUTDOOR RATING:</b>	IPX4

## Register Your Product Online

### Register Your NewAir Product Online Today!

Take advantage of all the benefits product registration has to offer:



#### Service and Support

Diagnose troubleshooting and service issues faster and more accurately



#### Recall Notifications

Stay up to date for safety, system updates and recall notifications



#### Special Promotions

Opt-in for NewAir promotions and offers

Registering your product information online is safe & secure and takes less than 2 minutes to complete:

[newair.com/register](https://newair.com/register)

Alternatively, we recommend you attach a copy of your sales receipt below and record the following information, located on the manufacturer's nameplate on the rear of the unit. You will need this information if it becomes necessary to contact the manufacturer for service inquiries.

**Date of Purchase:** \_\_\_\_\_

**Serial Number:** \_\_\_\_\_

**Model Number:** \_\_\_\_\_

## SAFETY INFORMATION & WARNINGS

### **Intended Use:**

This product is intended for residential and office use etc. For industrial or other commercial applications use only with electrical wiring that is in good working order and that meets applicable codes and ordinances. If you have any questions whether your wiring is adequate, consult a qualified electrician or contact customer service at [support@newair.com](mailto:support@newair.com).

While using your fan, you should follow the IMPORTANT INSTRUCTIONS listed below. As part of those instructions, we have used the word "WARNING" to indicate the level of hazard: WARNING indicates a hazard which, if not avoided, could result in injury or death.

## IMPORTANT INSTRUCTIONS

As with all electrical appliances, basic safety precautions should always be followed to reduce the risk of electric shock, fire, or injury to persons, including the following precautions:

- Read all the instructions before using this fan.
- Use this fan only as described in this manual. Any other use not recommended by the manufacturer may cause electrical shock, fire or injury to persons.
- Do not operate the fan with a damaged power cord or after the fan malfunctions or has been dropped in any manner.
- Use of extreme caution is necessary when any fan is used by or near children, disabled persons or pets and whenever the fan is left operating unattended.
- Do not place the fan on a small, unlevel, uneven or any surface which might allow it to tip or fall.
- For proper operation, the fan should be placed on a smooth, non-combustible, level surface.
- Always unplug fan when not in use, when moving from place to place, when assembling or disassembling parts, and before cleaning.
- The use of attachments is not recommended, and they are not sold by the manufacturer, as they may cause hazards.
- Do not use the fan in a window. Rain or other environmental effects could cause an electrical hazard.
- Do not operate the fan with blade guards or any safety device removed.

- Avoid the use of extension cords due to risk of fire. If an extension cord must be used, the cord must be minimum 14 AWG and rated not less than 1875 watts.
- Do not run the power cord under carpeting. Do not cover the cord with throw rugs, runners or the like. Arrange cord away from traffic area where it will not be tripped over.
- Do not insert or allow any object to enter any openings on the fan. Doing so may cause electric shock and/or fire hazard. Avoid contact with moving parts.
- This appliance is not intended for use by persons (including children) with reduced physical, sensory or mental capabilities or lack of experience and knowledge, unless they have been given supervision or instruction concerning use of the appliance by a person responsible for their safety.
- Children should be supervised to ensure they do not play with the appliance.

The source of electrical supply is to be disconnected prior to the beginning of any such servicing or cleaning operation.

## WARNINGS



### **WARNING:** Shock Hazard

- Use your fan only in dry environments. This fan is not intended for use in a bathroom, laundry area, or similar locations, or near sinks, washing machines, swimming pools, or other sources of water.
- Never locate fan where it may fall into a bathtub or other water receptacle. Do not use in damp environments such as flooded basements.

### **WARNING:** Hot Surfaces

- Do not touch fan motor when in use. This motor is hot when in use; to avoid burns, do not let bare skin touch hot surfaces.

### **WARNING:** Fire Hazard

- Fans have arcing or sparking parts inside. Do not use near combustible materials, flammable gases or sources of heat. Do not use in areas where gasoline, paint or flammable materials are used or stored. To prevent a possible fire, do not block air intakes or exhaust in any manner. Do not insert or allow foreign objects to enter any ventilation or exhaust opening as this may cause an electric shock or fire, or may damage the fan.

### **WARNING:** Electrical Shock Hazard

- Do not use with damaged cord or plug. Use with adequate electrical system that is up to code.

**CAUTION:** To Prevent Electric Shock, this product has a three prong grounded plug that must be inserted into a matching properly grounded outlet to reduce the risk of electrical shock. Do not attempt to remove or tamper with this safety feature.

**WARNING:** To reduce the Risk of Fire or Electric Shock, do not use this product with any solid-state speed control device.

## ASSEMBLY INSTRUCTIONS

### ASSEMBLY

Installation work and electrical wiring must be done by qualified person(s) in accordance with all applicable codes and standards, including fire - rated construction. When cutting or drilling into a wall or ceiling, do not damage electrical wiring and other hidden utilities.

**WARNING:** The included mounting parts are intended to be used with drywall anchors only. Do not attempt to mount this unit on the wall or ceiling without proper drywall anchors.

Use the following information as a guideline only. It is the user's responsibility to be sure the location and the wall surface can handle the weight of this fan (12.7 lbs).

The wall fan must be mounted on 12 inch (300mm) thick dry and cement - grouted firm wall or on 4 by 5 inch wood studs / joists. Use wall bracket as a template for locating the holes to be drilled.

After determining the hole locations, use an appropriate sized drill bit and, drill holes through mounting surface. It is recommended that a minimum of grade 5 fasteners be used. The following are acceptable surfaces for mounting wall mount assembly.

**STEEL SURFACE** - When mounting to a steel surface, such as vertical I-beam, drill through holes at pre-marked locations, using a 9/32" drill bit. Attach wall mount assembly to mounting surface using 1/4"-20 hex screw, in combination with 1/4" flat washers, 1/4" lock washers, and 1/4"-20 hex nuts.

**MASONRY SURFACE** - When mounting to a masonry surface use a 1/4" expansion type bolt or 1/4" masonry lag with shield designed to handle the weight of this fan. Drill holes at pre-marked locations using appropriate sized drill bit as recommended for the fastener.

**FLOOR STAND ASSEMBLY:**

1. Remove the 4 screws from the base tube (fig. 1 & 2)
2. Align the screw hole on the side of the metal plate and the hole on the base tube, then insert the screw and nut to tighten. Do the same thing on the other side of the metal plate. (fig. 3, 4 & 5)
3. Align the screw holes in the middle of the metal plate with the holes in the fan bracket, then insert the screws and nuts to tighten (fig. 6, 7 & 8)

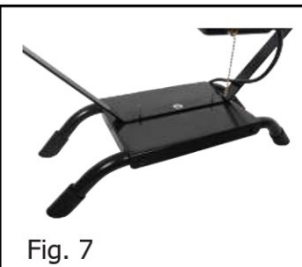
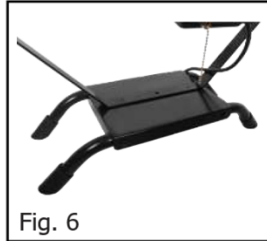
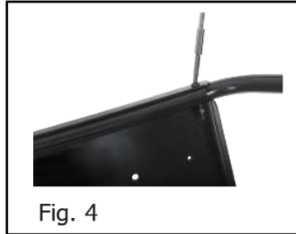
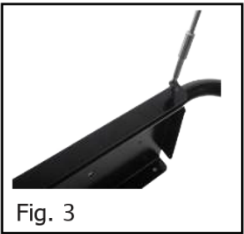
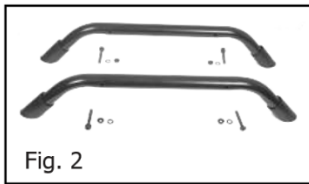
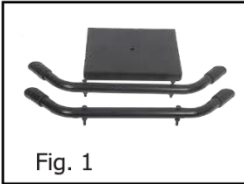



## OPERATION INSTRUCTIONS

### USING YOUR PRODUCT

**Fan operation:** Always operate the fan in an upright position following all instructions and recommendations listed in this manual.

**Fan location:** Place the fan in the area of the room that will provide proper fan cooling. (note: IPX4 outdoor rating is only meant to indicate resistance to occasional water splashes. It does not indicate that the fan is completely water-, dust- or dirt-proof)

**Fan connection:** Plug fan directly into 120 volt A.C., 60 Hz wall outlet. Be sure plug fits tightly in outlet. A loose connection may cause overheating and damage to the plug or fan.

**Note:** To prevent overloading a circuit, do not plug the fan into a circuit that is servicing other electrical needs.

**Speed control:** To operate the fan, each pull of the string will cycle through the following settings:

- OFF
- LOW
- MED
- HIGH
- OFF

## CLEANING & MAINTENANCE

**Cleaning:** CAUTION-Before cleaning the fan be sure to disconnect power cord from the plug. Clean the grille surface with a clean damp cloth. Do not use harsh chemical or abrasive cleaners. DO NOT IMMERSER THE FAN OR ANY WIRES IN WATER. Replace the front grille before fan use. Allow fan to dry completely before use. Periodic grille cleaning with a vacuum will prevent dust buildup. The motor is sealed and does not require any interior maintenance, cleaning or lubrication.

**Maintenance:** The Internal motor bearings are permanently lubricated at the factory and do not require any additional lubrication.

**Repair:** DO NOT OPERATE THE FAN WITHOUT THE GRILLE IN PLACE. DO NOT USE THE FAN IF IT HAS MALFUNCTIONED OR BECOME DAMAGED IN ANY WAY. If there are any issues with your unit, contact customer service through email at [support@newair.com](mailto:support@newair.com)

**Storage:** Keep original carton for storage of the fan. Coil and tie the power cord to avoid damage during storage.

1:

This product employs overload protection (fuse). A blown fuse indicates an overload or short-circuit situation. If the fuse blows, unplug the product from the outlet. Replace the fuse as per the user servicing instructions (follow product marking for proper fuse rating) and check the product. If the replacement fuse blows, a short-circuit may be present and the product should be discarded or returned to an authorized service facility for examination and/or repair.

#### Fuse Replacement:

1. Grasp plug and remove from the receptacle or other outlet device. Do not unplug by pulling on cord.
2. Open fuse cover by sliding open fuse access cover on top of attachment plug towards blades. See Fig. 2.
3. Remove fuse carefully. Use a small tool to pry the end of the fuse from holder cavity. Be careful not to break glass window.
4. Replace fuse. **WARNING:** Risk of fire. Replace fuse only with identical 2.5 or 5.0 Amp, 125 Volt fuse (3.6mm x 10mm). Be sure fuse is properly seated within its cavity.
5. Close fuse cover by sliding it back to its original closed position.

Fig 1

Fig 2

Fig 3



## TROUBLESHOOTING

<b>Problem</b>	<b>Possible Causes</b>	<b>Solution</b>
<b>The fan will not Operate.</b>	The fan is not plugged in and/or the electrical outlet isn't working properly.	Make sure the fan is plugged in and/or the electrical outlet is working properly.
	The circuit breaker may be tripped or there is a blown fuse.	Reset the circuit breaker or check for a broken fuse.
<b>The fan is not rotating.</b>	Obstructions are keeping the fan from working.	Check for obstructions. If you find an obstruction, turn the fan off. Unplug the fan and carefully remove the obstruction. Plug the fan in and turn it on again by referring to the operating instructions.

## LIMITED MANUFACTURER'S WARRANTY

This appliance is covered by a limited manufacturer's warranty. For one year from the original date of purchase, the manufacturer will repair or replace any parts of this appliance that prove to be defective in materials and workmanship, provided the appliance has been used under normal operating conditions as intended by the manufacturer.

### **Warranty Terms:**

During the first year, any components of this appliance found to be defective due to materials or workmanship will be repaired or replaced, at the manufacturer's discretion, at no charge to the original purchaser. The purchaser will be responsible for any removal or transportation costs, if needed.

### **Warranty Exclusions:**

The warranty will not apply if damage is caused by any of the following:

- Power failure
- Damage in transit or when moving the appliance
- Improper power supply such as low voltage, defective household wiring or inadequate fuses
- Accident, alteration, misuse or abuse of the appliance such as using non-approved accessories, inadequate air circulation in the room or abnormal operating conditions (extreme temperatures)
- Use in commercial or industrial applications
- Fire, water damage, theft, war, riot, hostility or acts of God such as hurricanes, floods, etc.
- Use of force or damage caused by external influences
- Partially or completely dismantled appliances
- Excess wear and tear by the user

Replacement parts and/or units will be new, re-manufactured or refurbished and is subject to the manufacturer's discretion. For technical support and warranty service, please email [support@newair.com](mailto:support@newair.com)