



Wheel balancer

DWC-9-E

OPERATING MANUAL



Manual

**Wheel balancer for passenger car wheels, trucks and
(optionally) motorcycle wheels.**

DWC-9-E

Serial number

Production date

SUPPLIER

Jema Autolifte A/S

Industrihegnet 2

Tel. (+45) 48180300

Table of Content

| | | |
|--------|--|----|
| 1. | Introduction | 5 |
| 1.1 | The manual | 5 |
| 1.2 | Preliminary work with the wheel balancer..... | 5 |
| 1.3 | Machine's identification data | 6 |
| 1.4 | Technical specification | 6 |
| 2. | Description of the wheel balancer | 7 |
| 2.1 | Machine equipment | 8 |
| 2.2 | Keyboard description..... | 9 |
| 3. | Safety | 10 |
| 3.1 | General precautions | 10 |
| 4. | Maintenance and scrapping of wheel balancer..... | 12 |
| 4.1 | Maintenance..... | 12 |
| 4.1.1 | Periodical maintenance..... | 12 |
| 4.2 | Machine scrapping..... | 13 |
| 4.2.1 | Fire protection..... | 13 |
| 4.2.2 | Accident prevention..... | 13 |
| 4.2.3 | Safety designing provided in the wheel balancer..... | 13 |
| 4.2.4 | Noise evaluation | 13 |
| 5. | Installation of the wheel balancer..... | 14 |
| 5.1 | Installation requirements | 14 |
| 5.1.1 | Power supply source requirements | 14 |
| 5.2 | Place of installation | 15 |
| 5.2.1 | Required working area | 15 |
| 5.3 | Mounting car wheels'holder | 16 |
| 5.3.1 | Description of the holder's elements | 16 |
| 5.3.2 | The clamp nut | 16 |
| 5.4 | Holder's elements..... | 17 |
| 5.5 | Mounting motorcycle wheels'holder | 18 |
| 5.6 | Mounting the hood..... | 18 |
| 5.7 | Fixing wheels on wheel balancer's holders | 19 |
| 5.7.1 | Car or delivery truck wheel | 19 |
| 5.7.2 | Mounting the spike holder..... | 22 |
| 5.7.3 | Car wheel in a spike holder | 23 |
| 5.7.4 | Motorcycle wheel | 24 |
| 6. | Working with the machine | 25 |
| 6.1 | Connecting the machine to a power outlet | 25 |
| 6.2 | Activating the wheel balancer | 25 |
| 6.3 | Selecting weight placement (ALU)..... | 25 |
| 6.4 | Other icons on the display | 26 |
| 6.5 | Changing of threshold | 27 |
| 6.6 | Input of parameter values | 27 |
| 6.6.1 | User memory | 28 |
| 6.6.2 | Imbalance recalculation..... | 28 |
| 6.6.3 | AUTOSTART function..... | 28 |
| 6.7 | Balancing a wheel..... | 29 |
| 6.8 | Automatic wheel positioning..... | 29 |
| 6.9 | Optimisation | 30 |
| 6.10 | "Hidden weight" program - 3P | 31 |
| 6.11 | Calibration | 32 |
| 6.11.1 | Calibration using the device | 32 |
| 6.11.2 | Calibration using a wheel | 32 |
| 6.11.3 | Balancing a wheel before calibrating with it..... | 32 |
| 7. | Diagnostics and fault detection | 33 |

Packing, transportation and storage information



ATTENTION: All operations concerning packing, lifting, moving, transporting and unpacking must be carried out by qualified personnel only.

Packing

The wheel balancer is sent as a complete piece of equipment (quick change holder, wheel balancer, protective hood, operating manual). The wheel balancer can be packed in a few different ways:

- pallet + stretch foil + carton box
- pallet + stretch foil
- pallet + carton box

Transport

The package can be lifted or displaced by fork-lift or pallet trucks. Once the cargo arrives at its destination, it is recommended to check if its contents have not been damaged during transportation. It is also recommended to check the conformity of the delivery with its bill of landing. In case of non-conformity or transportation damages it is necessary to inform without delay the responsible person or carrier about it. Moreover, the loading should be done with extreme precautions and consideration.



Storage

The machine should be stored in a dry room free of dust.

1. Introduction



WARNING: This manual is intended for personnel licensed to service the wheel balancer (operator) and those who carry out current maintenance. Before starting any operations concerning the balancing machine or the package, one should carefully study the manual. It contains important information concerning personal security of the operators and maintenance personnel as well as wheel balancer's operation.

1.1 The manual

For proper usage of this manual, the following should be applied:

- The manual must be kept in the proximity of the machine in a place of easy access.
- The manual must be kept in a dry place.
- The manual must be used properly with care not to damage it.

It is forbidden for operators who have not studied this manual to work with a balancing machine. This manual is an integral part of the wheel balancer and should always accompany the machine even if it is going to be sold.



ATTENTION: It is strongly advised to read carefully and repeatedly chapter 3 in which very important information and warnings concerning safety are contained.

1.2 Preliminary work with the wheel balancer



ATTENTION: Lifting, transportation, unpacking, assembly, installation, putting in motion, preliminary adjustment and testing, maintenance repairs, technical inspections, do not require the presence of service personnel but must be carried out with extreme precaution.



The manufacturer does not bear any responsibility for personnel injuries or vehicle and other object damages if any of the above mentioned operations will be performed not according to the service manual or the balancing machine was used in an improper way.

In the manual only the aspects of the servicing and security which can help operators and servicing personnel in a better understanding of the construction and working of the wheel balancer and to allow them to use it the best way possible were enumerated.

To understand the vocabulary used in the manual, operators must possess specific experience in servicing, maintenance, repairs, workshop works and ability to correctly decode all drawings and descriptions contained in the manual. Operators must also know general and detailed safety requirements obligatory in the installation country. The word "operator" used in this manual should be understood in the following manner: Operator: a person licensed to service a wheel balancer.

1.3 Machine's identification data

When contacting our authorized service, providing the model and serial number aids getting help from service Staff and quickens the process of sending spare parts. For convenience and clarity, a table is presented below. If any differences between the table below and the name plate on the machine, data on name plate apply. - **Fig. 1.1**

| | | |
|---|---|--|
| | | |
|  | | |
| Numer seryjny: | 01/14 | |
| Dane techniczne : | | |
| zasilanie elektryczne | 230 V / 50 Hz | |
| moc silnika elektrycznego | 80 W | |
| poziom hałasu | < 67 dB | |
| maks. masa koła | 60 kg | |
| maks. wymiary zewnętrzne | 1170x1000x1450 mm | |
| masa całkowita maszyny | 85 kg | |
|  | RoHS Compliant Directive 2002/95/EC |  EEE waste |
| Wyrób polski | | |

1.4 Technical specification

| | |
|--|------------------------------|
| Wheel diameter | 10"-30" |
| Wheel width | 2"-15" |
| Imbalance indication accuracy | lg |
| Imbalance location signal accuracy | 3° |
| Measurement time | approx. 7s |
| Wheel weight | up to 60kg |
| Drive motor rating | 80W |
| Spindle rotation speed during measurement | 160 rpm |
| Overall dimensions | |
| No hood, with wheel holder | 1000 x 580 x 900 mm |
| With hood opened | 1170 x 1000 x 1450 mm |
| Total machine weight | approx. 85 kg |
| Power supply | 230V/50Hz |
| Average level of acoustic pressure L_{av} | 65 dBA |

2. Description of the wheel balancer

DWC-9-E wheel balancer are designed for balancing of car and motorcycle wheels in a single measurement cycle. Original construction solutions assure safe, simple and comfortable operating of the machine as well as reliability and fast wheel balancing.

The wheel balancer is equipped with:

- quick mounting holder
- hood
- LCD display
- sound speaker
- automatic calibration program
- "**Hidden weight**" program
- optimisation program
- imbalance recalculation
- ALU program for working with aluminum rims
- user memory bank

The wheel balancer has following attributes:

- modern measurement system with a computer system for data processing to ensure fast and complete measurement with great accuracy,
- the possibility to choose a program for wheel handling (also for light aluminium rims) with every type of balancing weights - hammered or adhesive,
- the possibility of regulating balancing accuracy, according to the wheel's mass and state,
- easy programming and measurement with an ergonomic keyboard design, versatility of special holders enabling attachment of almost all wheel types,
- automatic calibration system that allows the machine to regulate the measurement system on its own if operator assumes incorrect imbalance indications of the machine,

2.1 Machine equipment

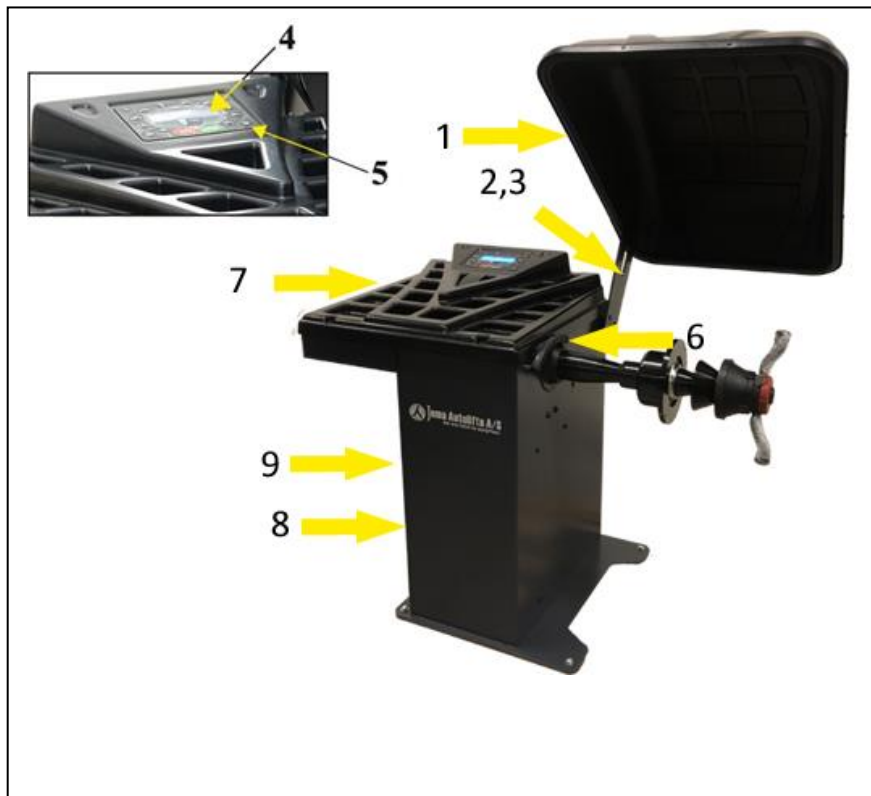
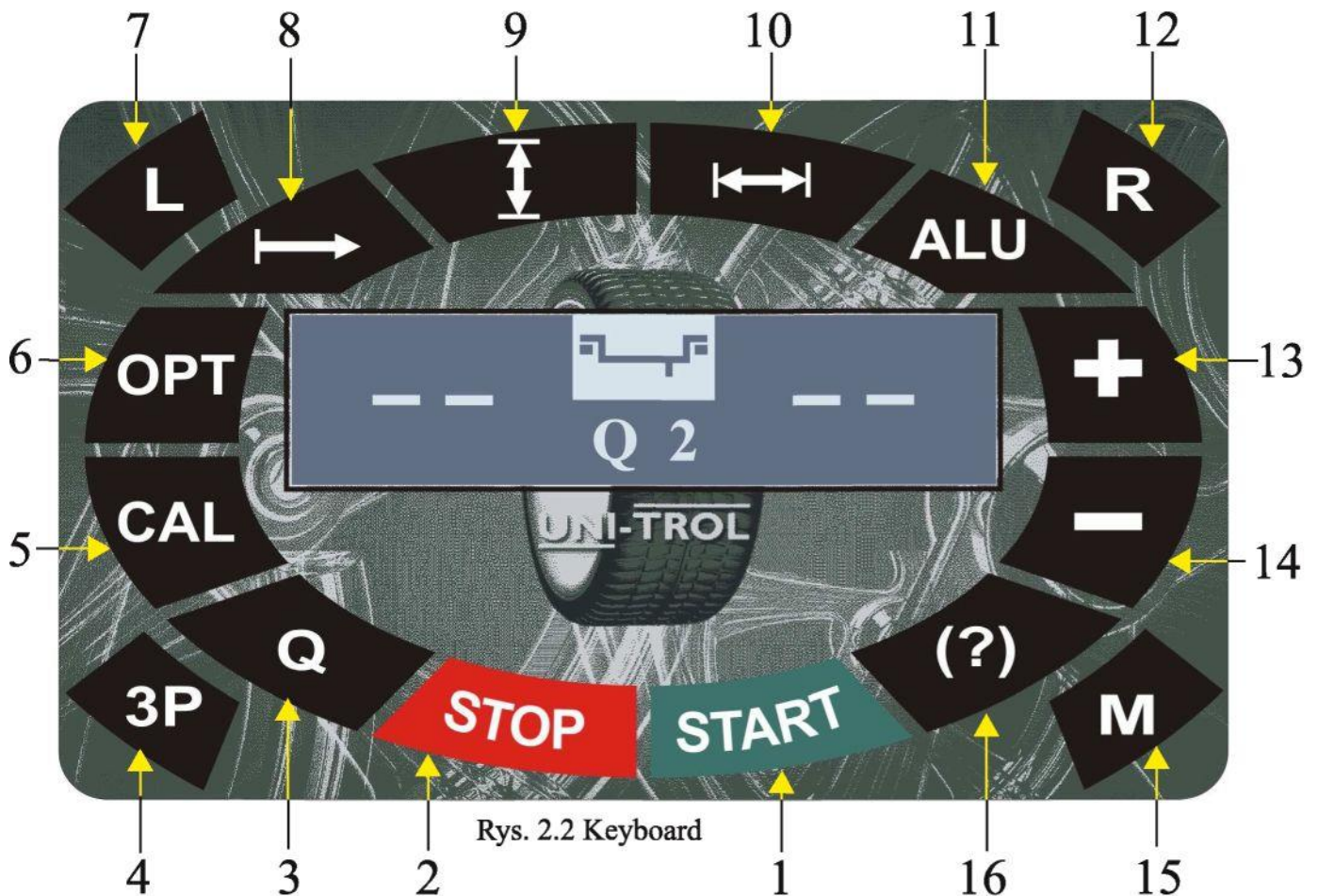

Fig. 2.1 Wheel balancer and its elements

- 1 Hood
- 2 Arm of the hood
- 3 Collar of hood's axis
- 4 LCD display
- 5 Keyboard
- 6 Adjuster
- 7 Machine's main switch
- 8 Power cable
- 9 Holders for additional elements

2.2 Keyboard description

Fig. 2.2 shows the wheel balancer's keyboard (5 in fig. 2.1). All functions of each button have been described in table 2.2.



Description of buttons' functions (from fig. 2.2)

| | | |
|----|----------|--|
| 1 | START | Starting of measurement cycle |
| 2 | STOP | Stopping a measurement cycle / imbalance correction place movement |
| 3 | Q | Changing of threshold |
| 4 | 3P | Activate " Hidden weight " program |
| 5 | CAL | Calibration |
| 6 | OPT | Optimisation |
| 7 | Left | Turn the wheel to left imbalance point |
| 8 | Distance | Setting distance parameter |
| 9 | Diameter | Setting diameter parameter |
| 10 | Width | Setting width parameter |
| 11 | ALU | Weight placement selection |
| 12 | Right | Turn the wheel to right imbalance point |
| 13 | Plus | Increase selected value |
| 14 | Minus | Decrease selected value |
| 15 | M | User memory |
| 16 | (?) | Recalculate imbalance of the wheel |

3. Safety



WARNING: This chapter should be read carefully because it contains important information for operators and other persons concerning hazards of using the wheel balancer in an inappropriate way.

Below are explanations concerning hazards and risks which can occur during balancing machine operating and maintenance. General and detailed precautions are given for avoiding potential hazards.



WARNING: The DWC-9-E wheel balancer was designed for the balancing of car and motorcycle wheels in one measurement cycle. Any work with the wheel balancer should be preceded by comprehensive reading and understanding of this manual. Any other type of usage of this balancing machine is not allowed. In particular, the wheel balancer is not intended for balancing other elements.



ATTENTION: The manufacturer and the dealer do not bear any responsibility for personnel injuries or vehicle and other objects' damages in case of improper or unauthorized use of the wheel balancer!
Any operation of the wheel balancer is not allowed without prior closing of safety hood. Not satisfying the above mentioned recommendations can result in serious human injuries and irreparable wheel balancer's damages and wheel damages.

3.1 General precautions

It is required that the operator and the maintenance technician adapt safety rules obligatory in the country of installation. Moreover, the operator and the maintenance staff should read all the information regarding safety placed on the machine and all the information included in this manual.

Risk of electric shock - hazard of electric shock can occur in those wheel balancer areas, where electric cables are placed. Use of water sprayers, vapour sprayers (high pressure washing units), dissolvers and painting equipment is not allowed in vicinity of the wheel balancer and in particular they should not be in contact with the control unit.

Impact risk - during operation of the machine here is a risk of some parts of the balancing machine hitting the operator. With the protective screen open, personnel must preserve all precautions to avoid hitting against machine parts.

Risk of wheel easing - before balancing starts, one should check if the wheel is properly and firmly fixed in the machine's holder.



ATTENTION: It is forbidden to unscrew the wheel during machine work!
It is forbidden to use wheels excising the maximum wheel weight - **60 kg!**
It is forbidden to leave the machine unattended during work!
It is forbidden to initiate a measurement with an incorrectly mounted wheel!

Skid risk - this hazard can be caused by floor contamination with grease in the proximity of the wheel balancer. The area under the wheel balancer, the holders and the area near them must be kept clean at all times. All the oil spots should be removed instantly.

Hazard caused by poor illumination - the operator and the maintenance technician must have the possibility to check if all areas of the wheel balancer are properly and uniformly illuminated according to the regulations applied in the installation place.

Risk of wheel balancer defect during work - to produce a reliable and safe balancing

machine, the manufacturer applied suitable materials and manufacturing techniques that are necessary for this type of equipment. Nevertheless the wheel balancer should be operated according to the producer's recommendations. Technical service (after warranty period) and other maintenance works described in chapter

4.1 - "Maintenance" should be carried out with specified periodicity.



ATTENTION: All operations of the wheel balancer contrary to its function can cause danger, serious damage or accidents to anybody near the machine. It is crucial to scrupulously observe all recommendations contained in this manual concerning maintenance and safety.

Risk involving machine's moving parts - During any kind of operations all limbs should be kept as far from moving parts as possible at all times. Necklaces, bracelets and loose clothes as well as long hair may cause potential danger to the operator. It is mandatory to take any jewellery off, wear clothes fit close to body and use headgear. The operator should use appropriate shoes to prevent any lower limb injuries.

4. Maintenance and scrapping of wheel balancer

4.1 Maintenance

Maintenance should be conducted by experienced personnel with knowledge concerning the principles of wheel balancer's operation. During the maintenance process one should preserve all precautions in order to avoid any accidental start of the balancing machine. The master switch should be pushed out and its light should be off. One should also adhere to all instructions given in chapter 3 "Safety".

4.1.1 Periodical maintenance

In order to keep the wheel balancer in a good operational state one should observe the below mentioned indications:

- Clean your wheel balancer at least once a month without using any chemical washing agents or high pressure spray guns.
- Check the operational state of all equipment periodically.
- Lubricate all holders periodically and keep them clean.
- Check the state of all cords once a year.



ATTENTION: Disregard of these recommendations will dismiss the manufacturer from any responsibility included in warranty.



WARNING: Always remove all dirt from the area near the wheel balancer.

4.2 Machine scrapping



ATTENTION: During machine scrapping one should preserve all precautions described in chapter 3, also applied during assembly.

As well as assembly, disassembly has to be executed by trained personnel only. All metal parts should be utilized as metal scrap. In all cases of machine scrapping, the utilization of all materials has to be conducted according to the rules applied in the country of installation.

One should also notice that for tax purposes, effective machine scrapping should be documented in reports and forms according to the rules applied in the installation country.

4.2.1 Fire protection

This machine does not constitute fire hazard. Nevertheless, room in which the balancing machine is installed, has to fulfill requirements of fire protection regulations applied in the country of installation.

Always keep one or more portable fire extinguishers within the operator's reach (operator zone), in order to prevent any fire hazard.

4.2.2 Accident prevention

During lifing/lowering, shifting, installing, assembling and disassembling of the balancing machine, one should preserve all precautions provided in regulations concerning accident prevention applied in the installation country. Moreover, all regulations concerning fork-lift trucks have to be preserved.

4.2.3 Safety designing provided in the wheel balancer

The machine has been equipped with a hood, which protects the operator with revolving parts of the balancer. The machine has been designed in such manner as not to initiate a measurement by accident or start one with the hood opened.

Each measurement initiation has to be preceded with pressing the  , button, which starts only a single measurement (assured by software).

Due to many safety design constructs, it is impossible for the machine to initiate any kind of measurement sequence on its own.

If any other incidental situations not mentioned in this operating manual occur, the operator is to immediately stop working with the machine, call authorized service and describe the problem.

4.2.4 Noise evaluation

Noise emission approximations were conducted in ordinary surroundings for a wheel balancer using environmental correction, defined and simplified by norm PN-EN ISO 11202. Measurements were made using a 20" wheel, weight approximately 30kg and in correct working conditions, i.e. nominal power supply conditions.

Measurements using a calibrated microphone were performed during a period from start of measurement and reaching maximal rotation speed to turning the drive motor off and stopping the wheel completely. For evaluation purposes an average from a couple of maximised measurements has been taken.

Average level of acoustic pressure $L_{av} = 65$ dBA

5. Installation of the wheel balancer



WARNING: These operations can be executed by persons who were earlier trained in servicing equipment described in this manual. To avoid possible wheel balancer damage or causing human injuries, it is necessary to preserve mentioned instructions. One must make sure nobody is within the working area of the machine.

5.1 Installation requirements

The wheel balancer has to be installed at a safe distance from walls, columns or any equipment. The room must be equipped with an electric power source. The balancing machine can be positioned on any surface, provided it is hard and perfectly horizontal. All parts must be uniformly illuminated, for the light intensity assures safe completion of all regulations and maintenance works specified in this manual. The presence of shaded places, light reflections or dazzling light is unacceptable. One must avoid any situations leading to eye fatigue. Illumination must be installed according to the regulations obligatory at the installation place (it is the responsibility of the light installation contractor).

Before starting the installation process, it is recommended to unpack all parts and check for any type of damage. All matters concerning displacing and lifting were discussed in chapter "Packing, transportation, storage".



**ATTENTION! THE MACHINE MUST NOT BE PERMANENTLY SCREWED TO ANY SURFACE!
HOLES IN THE BOTTOM PART OF THE MACHINE ARE FOR TRANSPORTING PURPOSES ONLY!**

5.1.1 Power supply source requirements

Wheel balancer is powered using a single phase alternating current 230V/50Hz. It should be connected to a power socket using an appropriate plug and secured with a 30mA residual-current fuse. Additionally the machine is protected from over current using a 2A fuse.

2.1 Place of installation

The wheel balancer should be installed in a locked, dry and heated (during autumn/winter season) room. Humidity should be between 30-95% with no vapor condensation. Temperature should be kept between 0-55 °C. The surface on which the wheel balancer will be standing should be hard and horizontal (best if concrete).

The machine should be placed on four rubber backings provided with the equipment. They should be placed under four legs welded to the wheel balancer's base.

2.1.1 Required working area

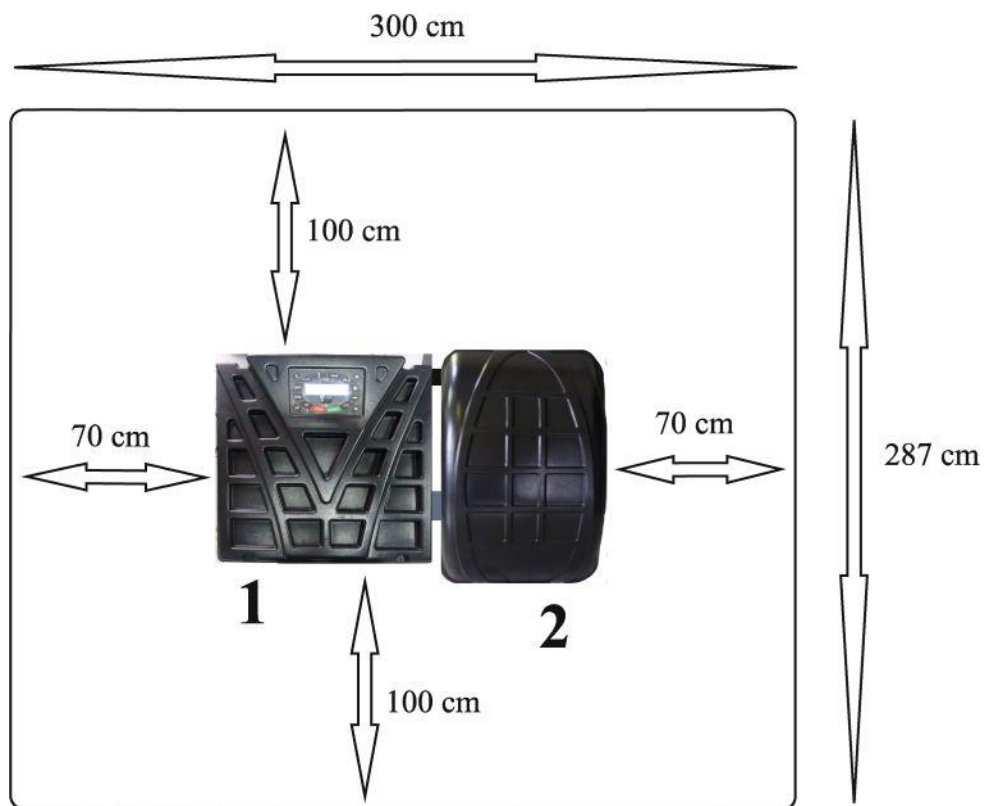

Fig. 5.1 Machine surroundings: minimal distance from walls and operator's working setting.

5.3 Mounting car wheels' holder



WARNING: The wheel balancer may be delivered with an already mounted holder.

An assembled holder for car wheels with rims having a central mounting hole is shown in fig. 5.2.

Before mounting the holder, clean the cone surface of the spindle and the surface of the holder (1, 2). Place the holder on the spindle so the position of the markers (3) on the spindle's snug and on the holder is aligned as shown in the figure. Lastly, screw the holder onto the spindle with the bolt (4).



ATTENTION: Careful cleaning of the cone surface and maintaining the position of the holder's markers is a crucial condition for accurate measurement.

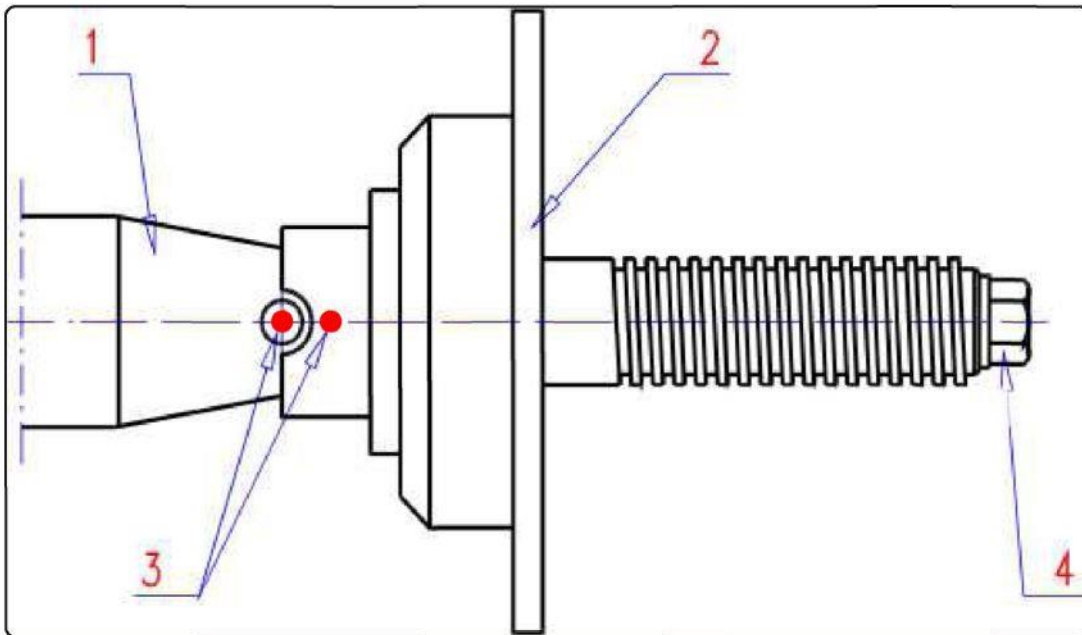

Fig. 5.2 Holder for car wheels (with no nut, cone or bushings)

1: Spindle 3: Markers
2: Holder 4: Bolt

5.3.1 Description of the holder's elements

The fast mounting holder was designed for car wheels with rims having a central hole. Figure 5.5 shows all of the holder's elements with their description.

5.3.2 The clamp nut

Figure 5.3 shows the clamp nut in two positions: (a) (**CLEARANCE**) - one can freely move the nut along the thread, (j) (**CLAMP**) - the nut can be screwed on the thread of the shaft.

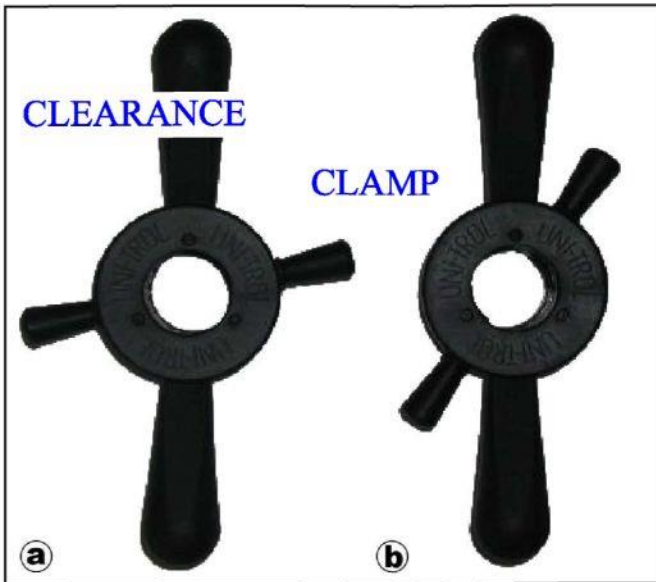

Fig. 5.3 Clamp nut



Fig. 5.4 Nut with mounted clamp.

5.4 Description of the holder's elements



Fig. 5.5 Elements of the holder:

- | | |
|---|--|
| 1: holder with flange | 7: centering cone no. 2 |
| 2: clamp nut | 8: centering cone no. 3* |
| 3: bolt used for mounting the holder on the spindle | 9: centering cone no. 4* |
| 4: cone spring | 10: centering cone no. 5 (110-125mm)* |
| 5: nut clamp | 11: centering cone no. 6 (125-145mm)* |
| 6: centering cone no. 1 | 12: centering cone no. 7 (145-165 mm)* |
| | * _ extra equipment |

5.5 Mounting motorcycle wheels' holder



ATTENTION: Motorcycle wheels' holder is not standard equipment and - if needed - can be purchased separately



WARNING: The wheel balancer may be delivered with an already mounted holder.

Mounting motorcycle wheels' holder is very similar to mounting car wheels' holder, which was described in chapter 5.3. In fig. 5.6 the holder has been presented and all of its parts described.

For proper holder mounting, the holder's bar with a matching base (1) should be placed on the machine's spindle (1 in fig. 5.2). Secondly, the holder's axis (3) is to be screwed to the spindle using the shorter thread and tightened using a size 22 wrench.

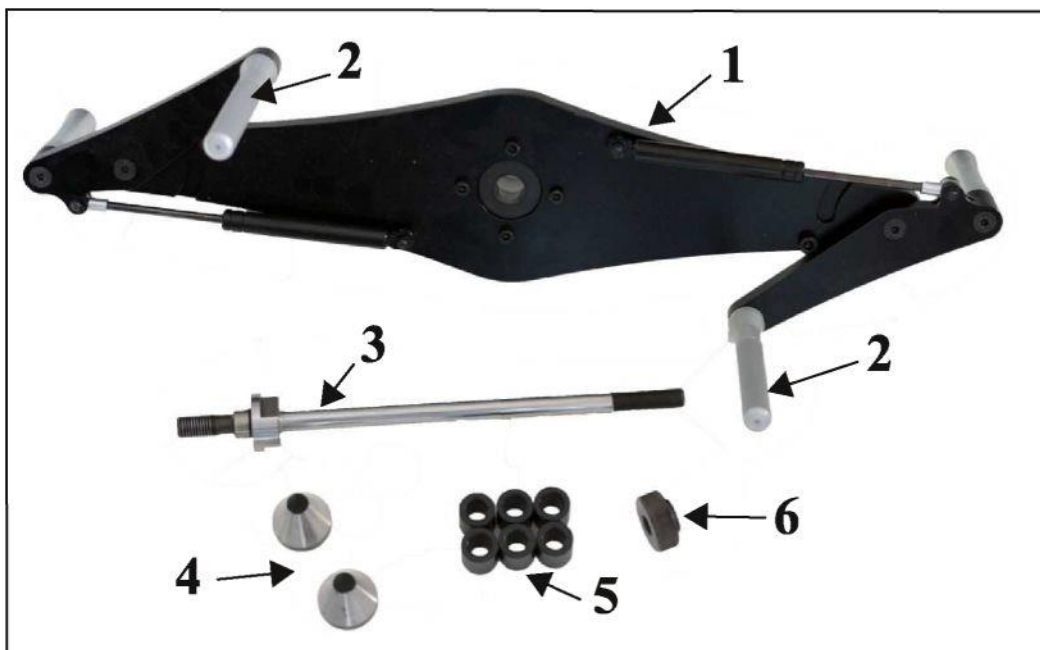

Fig. 5.6 Motorcycle wheel's holder elements:

- | | |
|------------------------------|---------------------------|
| 1 : holder's bar with a base | 4: cone muff - 2 pcs. |
| 2: tyre clamps | 5: distance muff - 6 pcs. |
| 3: holder's axis | 6: holder's screw. |

5.6 Mounting the hood

The description and numeration below is based on figure 2.1.

- Unscrew all bolts from the collar (3),
- While holding the hood (1) set it in such position that holes in arm of the hood (2) are aligned with holes in the collar (3),
- Screw the arm (2) to the collar (3).

5.7 Fixing wheels on wheel balancer's holders

5.7.1 Car wheel

Figure 5.7 shows four stages of mounting a car wheel on the wheel balancer's holder. Firstly, one has to slide the wheel on the radix of the holder (fig. 5.7(a)) and hang its hole's edge on the centering cone (fig. 5.7(2)). Secondly, place the collar of the nut in CLEARANCE position and slide the nut on the radix until there is no more space (fig. 5.1(c)). Then, using left hand to lift the wheel, place the thumb on the stud of the nut, move the collar to the left to CLAMP position and screw the nut pressing to the flange of the holder (fig. 5.7(2)).

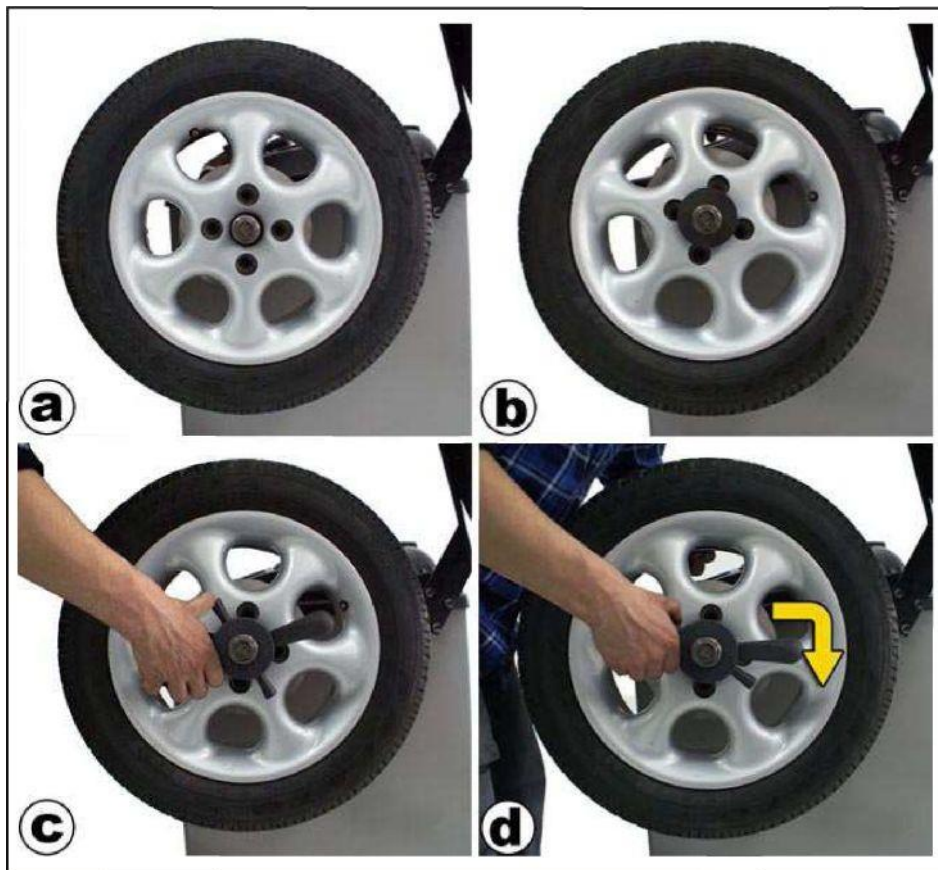

Fig. 5.7 Mounting a car wheel in the holder.

Figure 5.8 shows two stages of dismantling a car wheel from the wheel balancer's holder. In order to dismantle the wheel, place the holder's collar in CLEARANCE position (fig. 5.8(a)) and then turn the nut a little (fig. 5.8(2))- When it becomes loose, one can slide the nut and the wheel from the holder.



Fig. 5.8 Dismounting the wheel from the holder.

Construction and equipment of the holder make it possible to mount wheels with different rim shapes and different central hole diameters which is shown in figure 5.9. If using one of the centering cones, the wheel should be mounted from the outer side like in fig. 5.9(a) and 5.9(д), without using nut clamp 5 nor cone spring 4 (fig. 5.5). If due to the rim mounted the cone is to be placed from the inner side, the nut clamp should be put onto the clamp nut (fig. 5.4), spring with a matching cone slid to the handle in such manner that bigger basis is facing the machine. Lastly, slide the wheel onto the cone and screw it firmly to the holder using the clamp nut.

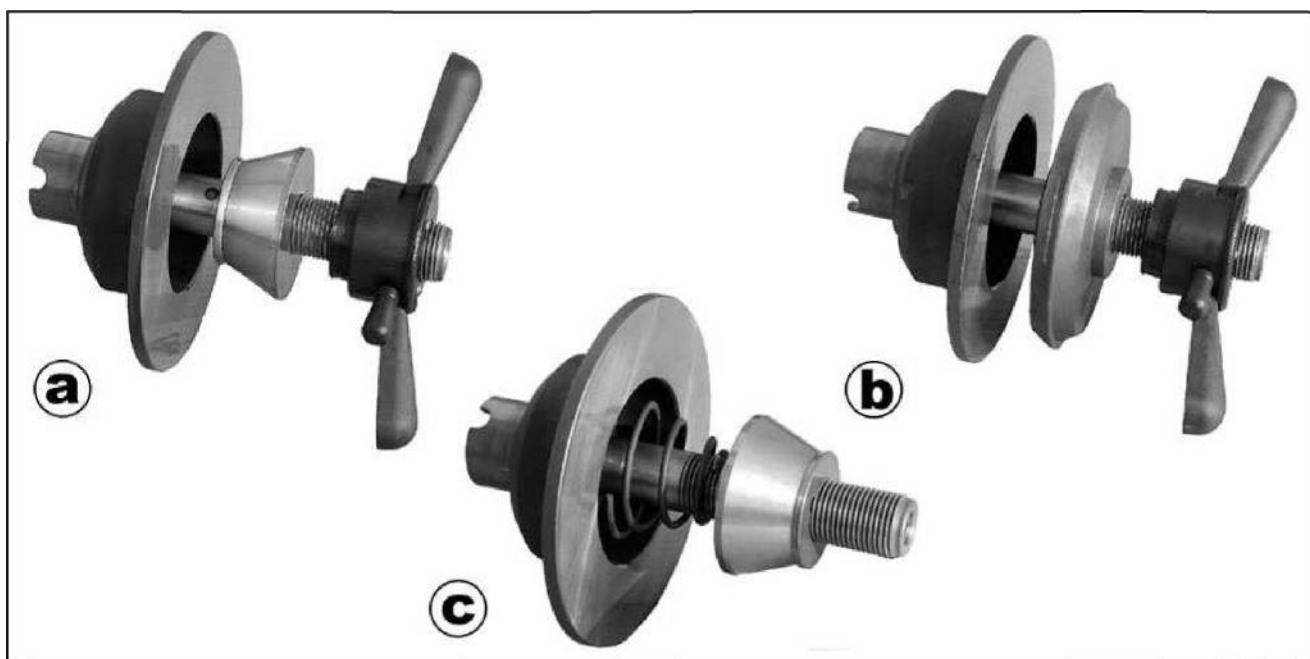

Fig. 5.9 Various methods of using the holder and its equipment.

When centering disks and cones are used for centering from the external edge of the rim, one should take the clamp off the nut. In order to do so, pull the clamp along the axis so it goes off the detent. One can gently dent it with a screwdriver. In order to put the clamp on, push it in the nut's detent.

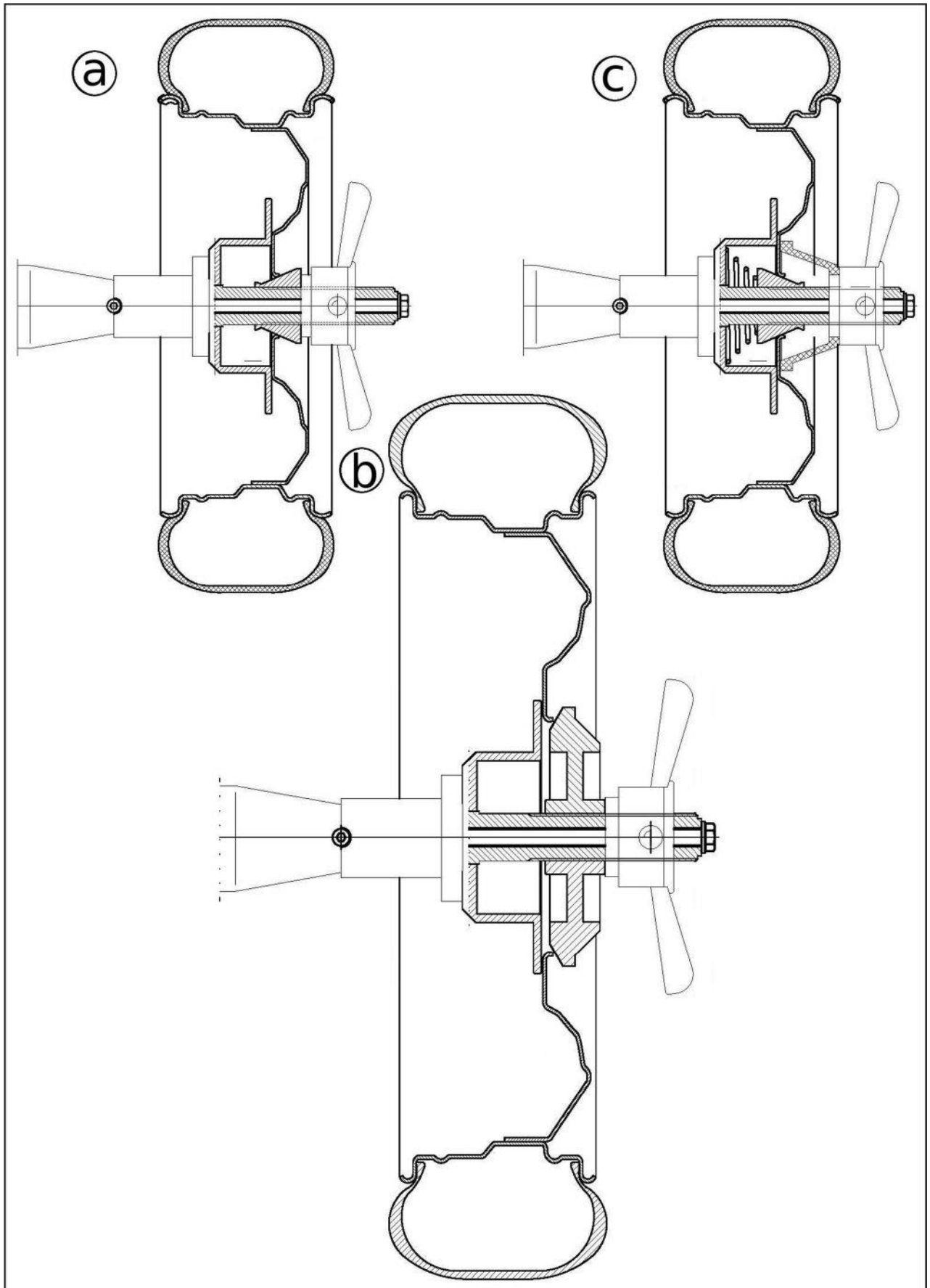

Fig. 5.10 Different ways of mounting wheels for various cones and their configurations.

5.7.2 Mounting the spike holder



ATTENTION: Spike holder is not standard equipment and - if needed - can be purchased separately.

Spike holder, presented and described in figure 5.11 is used for wheels without a central hole. Wheels having 3,4, 5 and 6 holes can be mounted on the holder. Due to the fact that mounting a spike holder is dependent on the balanced wheel, the whole procedure has been described in chapter 5.7.3 .



Fig. 5.11 Spike holder's elements:

- | | |
|------------------------------|--|
| 1: holder's disc | 7: centering muff 058 |
| 2: spikes for wheel mounting | 8: centering muff 060 |
| 3: plates | 9: centering muff 065 |
| 4: pad for mounting bolt | 10: cone screw |
| 5: centering muff 055 | 11: spherical screw |
| 6: centering muff 056 | 12: bolt used for mounting the holder on the spindle |

5.7.3 Car wheel in spike holder

If any holder other than the spike holder is mounted, it should be dismantled. If the rim does not have a central hole, the spike holder should be used. Figure 5.12 presents four

stages of mounting a wheel onto the described holder.

Firstly, depending on the wheel, all muffs should be checked (5-9 in fig. 5.11) to see which one fits best to die hole inside the rim. If none of them fit or there is no hole inside the rim, the pad 4 in fig. 5.11 should be used. Secondly, the disc 1 in fig. 5.11 should be mounted onto the machine's spindle and screwed using the provided bolt (12 in fig. 5.11) with the selected muff or pad, as presented in fig. 5.12(a).

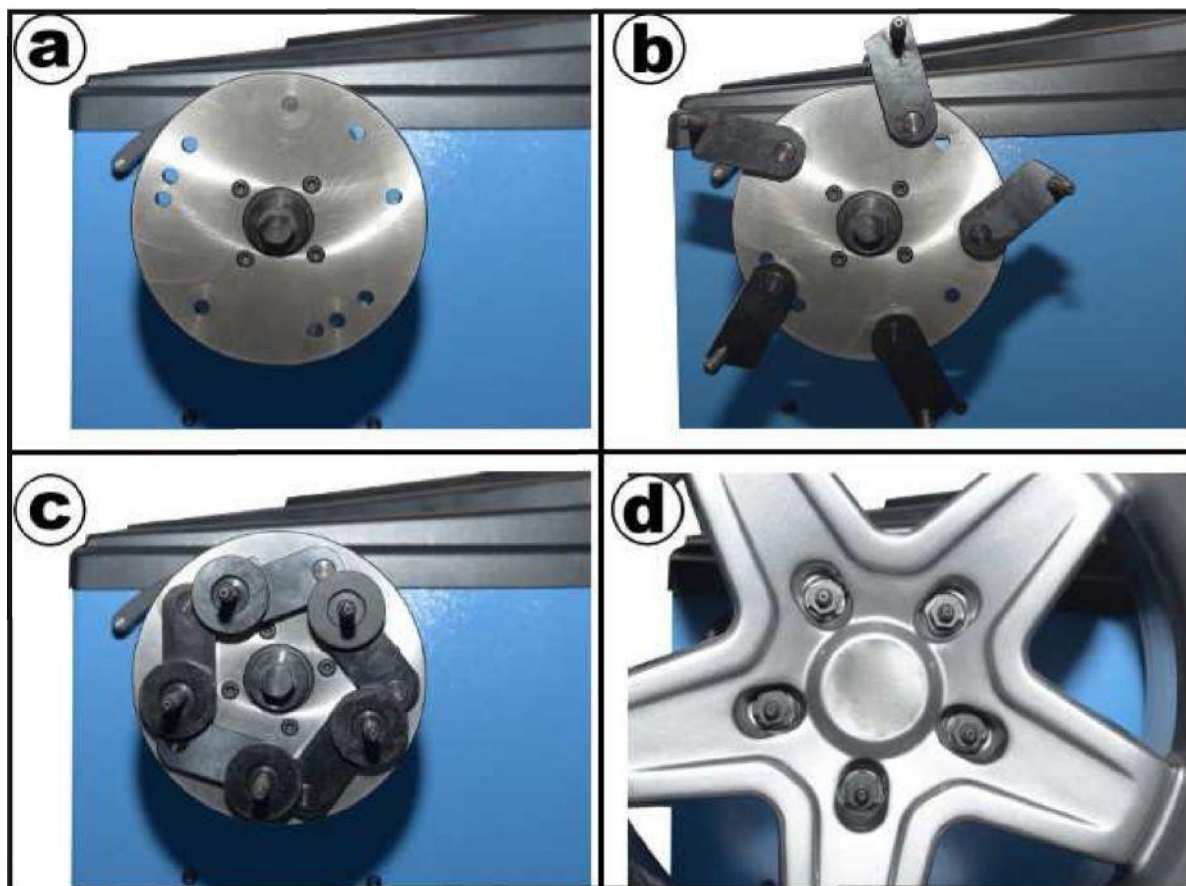

Fig. 5.12 Mounting a wheel without a central hole on the spike holder.

Depending on the number of holes in the rim, place the spikes (2 in fig. 5.11) on the disc according to the numbers imprinted on the back. For example, if the rim has 5 holes, all spikes should be placed in holes which have the number 5 at the back of the disc (fig- 5 .12(^)), if it has 6 holes, then 3 spikes should be placed in holes with the number 3 at the back of the disc and put into the rim through every second hole. The spikes should be screwed using the provided nuts and washers in such manner that the spikes are firmly screwed, but can be tightly rotated (first the flat washer, next the spring washer and lastly the nut). If enough free space is available, place the plates onto the spikes with the indentation facing outwards and set them in a position which makes it possible to put the wheel on the holder (fig. 5.12(c)).



WARNING: If any problems arise with spikes placement in relation to the rim holes during wheel mounting, the holder can be firstly set - before putting it on the spindle - on a dismantled wheel.

Depending on the female screws used in the car for wheel mounting, either cone screws (**10** in fig. **5.11**) or spherical screws (**11** in fig. **5.11**) should be applied to install the wheel on the holder (fig. **5.12(J)**).

5.7.4 Motorcycle wheels

Figure **5.13** presents four steps of installing a motorcycle wheel in the wheel balancer's holder. Firstly, the operator must make sure that tyre clamps **2** in fig. **5.6** are opened, then slide one of cone muffs **4** in fig. **5.6** on the axis (fig. **5.13(a)**) -Next, after sliding the wheel to the end of the axis and placing it on the cone (fig. **5.13(b)**) put the other cone muff on the axis in such way that it enters the wheel's bearing. For the wheel to be tightly mounted on the holder, distance muffs **5** in fig. **5.6** should be placed after the second cone so that there is enough thread at the end of the axis for the holder's screw **6** in fig. **5.6**, like in fig. **5.13(c)**. When everything is tightly mounted and the wheel is not loose, close the tyre clamps so they touch the wheel's tyre (fig. **5.13(d)**).



Fig. 5.13 Mounting motorcycle wheel on the holder.

6. Working with the machine

6.1 Connecting the machine to a power outlet



ATTENTION: Connect the power cord to a 230V/50Hz power outlet.



ATTENTION: because rapid heating of a frozen metal and plastic body results in lots of condensation on its surface, one should not plug a cold machine into a power outlet until 2 to 3 hours have passed required for all the electronic elements to dry and reach the ambient temperature.

Not complying with this requirement may result in damaging the balancing machine, void warranty or - if the electric installation is not fully operational - an electric shock.

6.2 Activating the wheel balancer

In order to activate the wheel balancer, the power button (fig. 2.1 - 7) must be pushed in. After a control test ending with a signal,



6.3 Selecting weight placement (ALU)









After pressing  an arrow appears on the display located near the pictogram showing a rim cross-section with correction weight placement. Using the  and  keys one can choose one of the following weight placement variants:



Table 6.2

- | | | |
|---|---|--|
|  | ① | Balancing a car wheel with hammered weights on both sides of the rim. |
|  | ② | Static balancing (for slim rims, using one weight). Using this option for car wheels is not recommended. |
|  | ③ | Balancing a car wheel with adhesive weights inside the rim.. |
|  | ④ | Balancing a car wheel with hammered weight on internal plane and adhesive weight inside the rim. |
|  | ⑤ | Static balancing of a motorcycle wheel. (Applicable only after mounting an optional motorcycle wheels' holder). |
|  | ⑥ | Dynamic balancing of a motorcycle wheel. (Applicable only after mounting an optional motorcycle wheels' holder). |

6.4 Other icons on the display



Wheel accelerating and a measurement

Icons presenting weight placement methods



Adhesive weight placement using mechanical adjuster (DWC-9-E)



Adhesive weight placement using laser adjuster (DWC-9-E)



/Hammered/Adhesive weight placement on "12 o'clock"



Adhesive weight placement on "6 o'clock"

Icons presenting wheel position



Wheel at the imbalance position



Wheel at the opposite position relative to the imbalance's position

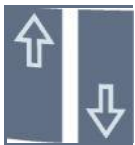

Rotate the wheel according to the arrow's pointing direction

Icons presenting calibration method



Calibration using the device



Calibration using a wheel

Icons presenting wheel parameters



Distance



Diameter



Width

6.5 Changing of threshold

Press the \leftarrow button on the keyboard. A pointer ($<$) will appear on the display on the side of the Q pictogram. The wheel balancer has four threshold values: 0, 2, 5 and 10 grams. Pressing either or the value of threshold is increased or decreased, respectively. Setting the threshold results in displaying "0" in a situation where the measurement result is less or equal the selected threshold.

6.6 Input of parameter values

Inputting the above mentioned parameters can be done in three different ways:

1. using saved data in one of four memory banks - see chapter 6.7.1
2. Setting values and configuring ALU using \leftarrow and keys - (by hand)
3. Setting Q and ALU with U or buttons and \leftarrow using the active adjuster.

Adjuster is a tool for automatic inputting after pressing \leftarrow or \rightarrow keys, for distance and diameter parameters, and even width for weight placement modes (3) and (4). Independent of whether the weight on the left imbalance plane is hammered or glued - the head of the adjuster is to be placed on the **desired weight placement position**. For hammered weights it should be placed on the edge of the rim as presented in fig. 6.1(a), whereas with adhesive weights on the side, as presented in eg. «Л® , and wait for the signal informing of simultaneously changing parameters and \leftarrow in the machine's memory.

ATTENTION! During diameter measurement, for some wheels, the result may differ from the NOMINAL diameter ($\pm 0.5''$). This does not affect imbalance measurement in any way since the real value is taken into account, measured with the adjuster.

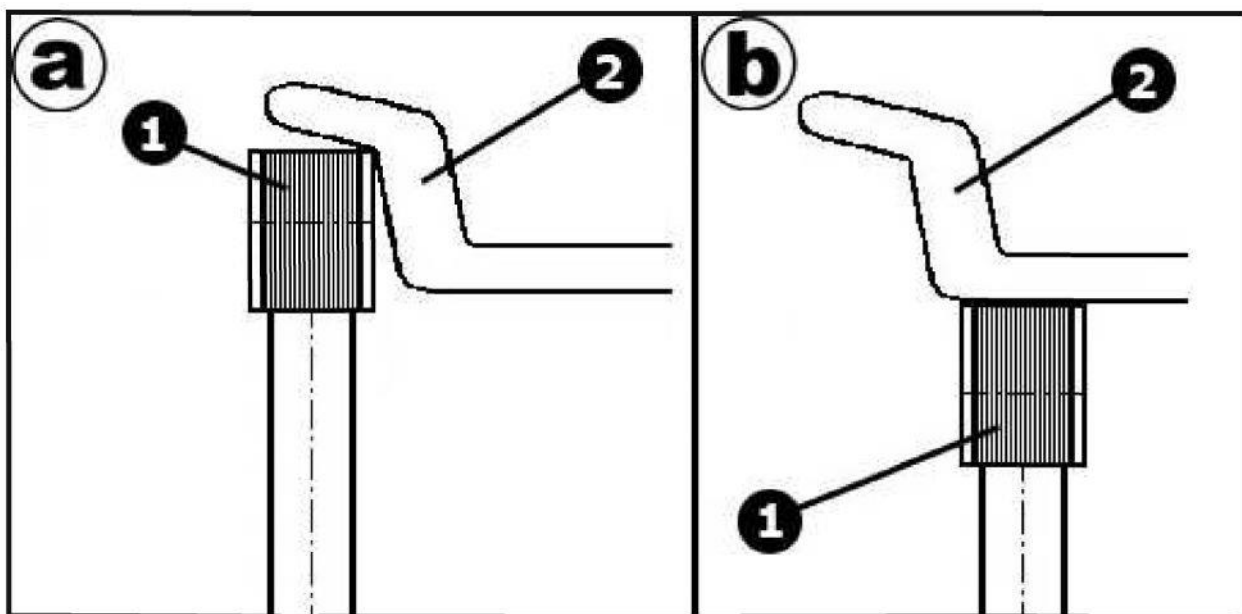

(a) for hammered weights

(g) for adhesive weights

(D - adjuster's head (2) - edge of the rim

Fig. 6.1 Positioning of the adjuster's head

6.6.1 User memory

Wheel balancers are equipped with internal memory, in which the operator can store four sets of wheel parameters. These parameters are: Diameter, Width, Distance and ALU (weight placement).

Memory tiding;
Pressing results in entering memory reading mode.

The following screen appears c



A screenshot of a dark blue rectangular display. The text "MEM1" is centered at the top, and "Czyt" is centered below it.

Using the **↵** and **←** keys one of the four memory banks can be chosen: MEM1 - MEM4. To read wheel parameters from the selected memory press again.

Saving to memory:
Pressing results in entering the mode of saving wheel parameters to memory.

The following screen appears c



A screenshot of a dark blue rectangular display. The text "MEM1" is centered at the top, and "Wpis" is centered below it.

Similarly as for reading mode select one of the memory banks MEM1 - MEM4 and press to save the current wheel parameters into the selected memory bank.

Reading from and saving to a memory bank is confirmed by the word "Czyt" (for reading) or "Wpis" (for saving) blinking twice on the display.

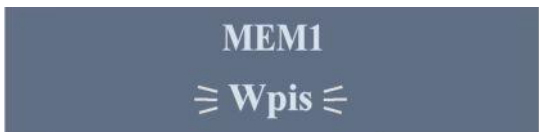

A screenshot of a dark blue rectangular display. The text "MEM1" is centered at the top, and "≡ Wpis ≡" is centered below it, with "Wpis" having a double underline.

6.6.2 Imbalance recalculation

Pressing makes the machine recalculate imbalance of the wheel with current parameters:

6.6.3 AUTOSTART function

The function AUTOSTART is enabled or disabled using the following key combination:
- while holding **↵** press **A** corresponding message will be printed on the display.

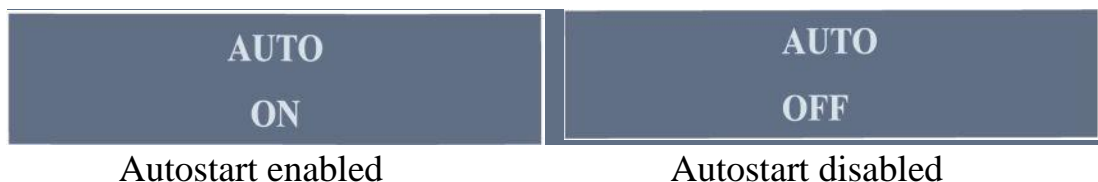

Two screenshots of the AUTOSTART function. The left screenshot shows "AUTO ON" on a dark blue background, with "Autostart enabled" written below it. The right screenshot shows "AUTO OFF" on a dark blue background, with "Autostart disabled" written below it.

6.7 Balancing a wheel

Balancing any wheel comes to evaluating the imbalance values for both internal and external correction planes and locating its position on the wheel. To correctly calculate these values one should input following data: WIDTH- DIAMETER- Δ , DISTANCE - choose weight placement and change threshold if necessary.

A measurement cycle after firmly mounting the wheel in the holder is initiated by closing the hood if AUTOSTART is activated, pressing $B^{\wedge}b$ - after closing the hood or pressing and at the same time without closing the hood - NOT RECOMMENDED. After the measurement cycle has finished imbalance values with weight placement locations where the weight should be put appear on the display. After placing the weights a control measurement should be conducted. If no mistake was made and the machine was properly calibrated, the obtained result should be which means that the wheel has been balanced withHEjiH] accuracy depending on the selected threshold and wheel alignment.

For hammered weights (see table 6.2) the correction place is signalled by a sound (different for each correction plane), a pictogram positioning weights and arrows pointing towards each other. The weight should be hammered at the highest point of the rim ("12 o'clock").

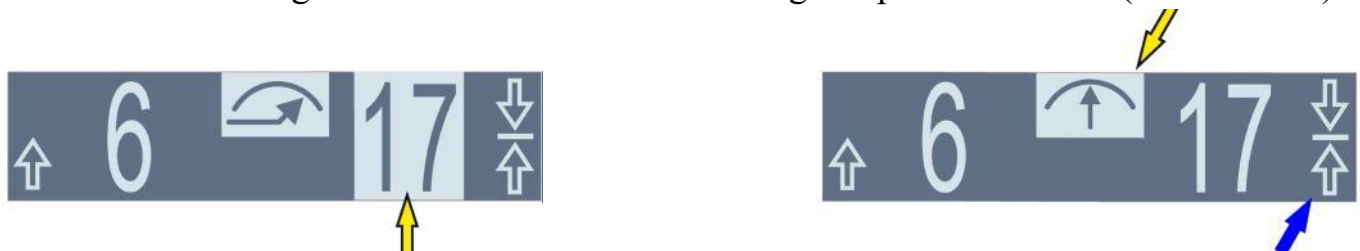

With adhesive weights (table 6.2) a different pictogram is shown on the display showing weight positioning, which should be placed on the rim the moment when the wheel is set to arrows *"pointing towards each other"* in the place where the tip of the properly protruded

adjuster touches the internal surface of the rim. Proper adjuster protrusion is signalled with displaying the imbalanceKWCTF Δ Bvalue in a .

Pressing the button now results in shifting the imbalance to the bottom of the rim ("6 o'clock") - for adhesive weights, or to the top of the rim ("12 o'clock") - for hammered weights, in accordance with the following icons: respectively

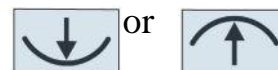

6.8 Automatic wheel positioning

The moment when the measurement cycle is over, imbalance values are displayed and the wheel stops rotating, the machine can automatically direct the wheel on one of the two imbalance positions, depending on the operator's choosing.

To start the automatic wheel positioning procedure to one of imbalance positions, the or ^ key has to be pressed for internal (left) or external (right) side of the wheel, respectively. In a short moment the wheel will be positioned in the vicinity of the selected imbalance location.

6.9 Optimisation



ATTENTION: Optimization is to be performed as a preliminary operation to wheel balancing using correction weights.

Optimization is a control test of a wheel providing rim and tyre alignment checking to ensure that imbalances coming from both cancel each other out. It helps diminishing the imbalance of the wheel and using smaller weights. Imbalances of both rim and tyre are performed in two measurement cycles and the result takes both correction planes into account.

Realisation of the procedure:

After mounting a bare rim in the holder in a specific way - easy to remember (e.g. valve matching the position of the marker on the spindle fig. 5.2) input the following parameters: Width, Diameter and Distance.

Pressing results in entering the optimization program and appearance of the following on the display:

**- OPTYMALIZACJA -
Felga**

Initiating optimization is done the same way as with a regular imbalance measurement (chapter 6.7). After completing the first part of the measurement and the spindle stops rotating the following will appear on the display:

The operator should dismount the bare rim from the holder, put a tyre on the rim, inflate to a specified pressure value and mount it on the holder the same way as the bare rim was mounted before (e.g. valve and marker way). Starting another cycle results in calculation of the values and positions of rim and tyre imbalances as well as the new positioning of the tyre relative to the rim. Additionally a profit will be evaluated (thrift of weight amount). Locating the positions indicated by the machine on the tyre and the rim is analogous to finding the external (right) hammered weight in regular imbalance calculation. Both positions should be marked (e.g. using chalk).

Lastly the operator should dismount the wheel from the handle, position the tyre on the rim so that both marked places are as close to each other as possible. Inflate the wheel to the specified pressure value and mount it on the machine's spindle in order to balance it. In order to leave the OPTIMISATION program press the key at any time.

If the tyre's position relative to the rim is optimal, there is no profit and hence the displayed value is zero.

ZYSK: 0

↓ Zaznacz
↑ Felga ZYSK: 25

Mark this position on the rim.

↓ Zaznacz
↑ Opona ZYSK: 25

Mark this position on the tyre.

6.10 "Hidden weight" program - 3P

The "hidden weight" program breaks down a single imbalance point. It is only available for weight placement modes (3), (4) and (5), (table 6.2). This function is used to break down the value and position of imbalance correction into two separate values and points so that the adhesive weights can be hidden behind the rim's spoke thanks to which they are not visible from outside (for a car wheel, modes 4 and 5) or split the imbalance so that it is possible to omit the spoke, which is exactly in the weight placement point (for motorcycle wheels, mode (5))•

Properly executing the program:

- Press * - displayed pictogram:



- find the location of the external (right) plane which switched to zenithal position ("12 o'clock")

- displayed pictogram:

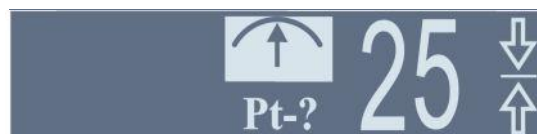

- Next choose spots in which the weights are to be placed (resulting from splitting the imbalance) by positioning them at the top ("12 o'clock") and confirming these selections by pressing ^ for both spots on opposite sides of the old imbalance position. Newly evaluated weights are to be placed in the pointed to spots using the "head of the adjuster" (Pt-1 and Pt-2, respectively).

Proper protrusion of the adjuster is signaled by displaying the imbalance value in a **negative**

- pictogram on the display:



First weight position



Second weight position

In this machine state, pressing the key results in moving the adhesive weight position to the bottom ("6 o'clock") - manual weight placement.

- Pictograms on the display^^



First weight's position



Second weight's position

6.11 Calibration

Attention! Each sold machine is already calibrated! Calibration is advised only in a situation where there exists a probability of machine recalibration (if e.g. displayed imbalance values do not reflect actual values).

Calibration process is about providing a pattern and saving in the machine's memory its reaction to it.

At present all manufactured machines give the operator an option to choose between calibrating with his own wheel or with an added device.

6.11.1 Calibration using the device

The calibrating device, provided with the wheel balancer, should be placed on the holder. After closing the hood ("AUTOSTART" turned off) press and hold key until a signal is heard and the following pictogram appears on the display:



6.11.2 Calibration using a wheel

Mount a prepared earlier wheel (steel recommended, initially balanced) on the holder. Input data and on the RIGHT! edge (external) hammer a model weight 80g. After closing the hood (AUTOSTART turned off) press for a moment, let go, then press and hold until the machine generates a signal and the following appears on the display:



Calibration procedure in both cases results in displaying the following (machine is ready for work):



ATTENTION: It is impossible to conduct a correct calibration if the wheel is not properly balanced. Even though the procedure may end successfully, the latter results will be afflicted by errors resulting from incorrectly executed calibration.

6.11.3 Balancing a wheel before calibrating with it

To balance a wheel before using it for calibration go to the balancing program, set the threshold to ^M0" and start a measurement. If there is no imbalance and two zeroes appear, the wheel is balanced and may be used for calibrating the machine. Otherwise it should be balanced until a control measurement shows zero-valued imbalance results. Only then calibration can be performed as described in chapter 6.11.2.

7. Diagnostics and fault detection

| FAILURE | POSSIBLE CAUSES | SOLUTION |
|---|---|--|
| The wheel balancer does not generate sounds, the power button is not lit, the display is blank. | Electric system failure, no electric supply. | Check the fuse, check if all electrical connections are in good condition. |
| Unstable, incorrect results of the adjuster measurement. | The photo couplers are dusted, broken pieces on code bar, damaged potentiometer. | Blow the photo couplers with dry air, replace the code bar, replace the potentiometer. |
| The keyboard's buttons do not activate all functions. | Poor contact of wires connecting the keyboard to the indicator's plate and indicator's plate to the main board, damaged keyboard. | Check all connections, replace the keyboard. |
| Incorrect indications for different wheel mountings. | Dirty spindle and/or cone, worn out centralizing cone, wheel improperly mounted, broken nut, broken holder (hit). | Change wheel mounting method, clean all dirty elements, replace the cone, replace the nut, replace the holder. |

NOTES

| | | |
|--|---------------------------|--|
| XXXXXX | | XXXXXX. XXXXXXXXXXXXXXXXXX |
| MANUFACTURING PLANT & STORE http://www.XXXX.XX | | tel. (+XX) XXXXX / XXXXXX / XXXXX fax (+XXX) XXXXX / XXXXXX / XXXXXX e-mail: XXXX@XXXXX.XX , XXX@XXX.XX |
| WHEEL WHEEL BALANCERS MM STRAIGHTENING MACHINES TYRE CHANGERS EQUIPMENT FOR TYRESHOPS | | |
| STATISTIC No. : 008132994 | EC VAT No. : PL5270205246 | EORI : PL527020524600000 |
| Account: for EURO : BZ WBK SA no : PL 62 1090 1014 0000 0000 0303 1619 | | SWIFT CODE : WBK PPL PP XXX |



CE Conformity Declaration
in accordance with directives : 2006/42/EC, 2006/95/EC, 2004/108/EC

We : XXXXXXXXXXXXXXX.
XXXXXXXXXXXXX
XXXXXXXX
Poland

declare, under our exclusive responsibility, that the product

Wheel wheel balancer
Electromechanical device
model DWC-9-E
Serial number.....

concerned by this declaration, complies with all relevant requirements of the Machinery Directive:

- Directive 2006/42/EC (safety machines) applicable in the essential requirements and relevant conformity assessment procedures, as well as on the essential requirements of the following directives:
- Directive 2006/95/EC (1^{ow} voltage)
- Directive 2004/108/EC (electromagnetic compatibility)

In order to verification of compliance with the applicable legal regulations have been

consulted harmonized standards and other normative documents:

- PN-EN ISO 12100:2012P
Safety of machinery — General principles for design - Risk assessment and risk reduction
- PN-EN 61000-6-3:2008?
Electromagnetic compatibility (EMC) — Part 6-3: General standards — Emission standard for environments: residential, commercial and light industrial
- PN-EN 61000-6-4:2008P
Electromagnetic compatibility (EMC) — Part 6-4: General standards — Emission standard for industrial environments
- PN-EN ISO 13857:2010P
Safety of machinery - Safety distances to prevent hazard zones being reached by

upper and lower limbs

PN-EN 349+A1:2010P

Safety of machinery - Minimum gaps to avoid crushing of parts of the human body

PN-EN 60204-1:2010P

Safety of machinery — Electrical equipment of machines — Part 1: General requirements

PN-EN 61293:2000P

Marking of electrical equipment with ratings related to electrical supply — Safety requirements

PN-EN 61204:2001/A1 :2002E

Low-voltage power supply devices, d.c. output - Performance characteristics and safety requirements

PN-EN ISO 11201:2012P

Acoustics — Noise emitted by machinery and equipment — Determination of emission sound pressure levels at a work station and at other specified positions in an essentially free field over a reflecting plane with negligible environmental corrections

PN-EN ISO11202:2012P

Acoustics — Noise emitted by machinery and equipment — Determination of emission sound pressure levels at a work station and at other specified positions applying approximate environmental corrections

PN-EN ISO 4871:2012P

Acoustics — Declaration and verification of noise emission values of machinery and equipment

PN-EN 50419:2008P

Marking of electrical and electronic equipment in accordance with Article 11 (2) of Directive 2002/96/CE (WEEE)

PN-EN 61190-1-3:2008E

Materials for connecting electronic components -- Part 1 -3: Particular requirements for solders for electronic applications and solders with fluxes or without fluxes for soldering electronic components

PN-EN 61760-1:2006E

Surface mounting technology — Part 1: Method qualification standard components for surface mount (SMD)

The technical documentation of this device, referred to in point 1 of Annex VILA of the Machinery Directive, is located in the headquarter of the manufacture. (address as above) and will be made available to the competent national authorities for at least 10 years after the last piece.

The person responsible for the preparation of the technical documentation of the product and introducing changes in it, is MSc. Gregory Tworek - Member of the Board.

This EC Declaration of Conformity will be kept by the manufacturer of the product for 10 years from the date of produce the last unit and will available for market supervisory authorities for verification.

**MSc. Gregory Tworek - Member
of the Board.**

Warsaw 15.04.2014

Signature

WARRANTY CARD

The warranty period is not valid if not all fields are filled in, including the signature of the owner.

Client name:

Serial no.:

Production date:

Delivery date:

Seller's signature and stamp:

1. Manufacture., hereinafter referred to as the Guarantor, provides a guarantee on the efficient operation of the above equipment within a period of months, however not longer than 30 months from the date of production.
2. Manufacture guarantees repairs of its own production equipment.
3. In the event of damage to the equipment during the warranty period Guarantor after declaring the complaint correct, it provides free repair of damages or replacement of parts. The repair time will not exceed 14 days from the date of submitting the equipment to repair.
4. The method of repair is determined by the Guarantor.
5. Any damage caused as a result of: operating and maintaining the machine inconsistently with the instruction manual, improper storage of equipment, improper transport, operation of equipment in climatic conditions incompatible with given in the manual or other reasons caused by the user, may be removed at its expense (not covered by the warranty).
6. In the event of an unjustified complaint, the applicant shall cover the costs incurred by the manufacturer: cost of technical inspection, access and other.
7. This card is the basis for free warranty repairs.
8. The warranty does not cover maintenance and adjustment activities such as: belt tension, oil refill, calibration etc.
9. Equipment up to 50 kg should be sent to the factory service through companies

I have read and accept the terms of the warranty

Legible signature / stamp of the owner

| Data | Repair done | Signature |
|------|-------------|-----------|
| | | |
| | | |
| | | |
| | | |
| | | |
| | | |
| | | |
| | | |