











480 | 8,0 t



-  Sollevatore elettro-idraulico a 4 colonne
-  **Electro-hydraulic 4 post lift**
-  Elektrohydraulische 4-Säulenbühne
-  Pont élévateur électro-hydraulique 4 colonnes
-  Elevador electro-hidráulico de 4 columnas



-  Sicurezza in caso di rottura fune • Sicurezza idraulica in caso di sovraccarico • Valvola di controllo velocità discesa • Valvola sicurezza in caso di rottura tubo idraulico • Comandi uomo presente 24V • Comando sgancio elettrico • Comando automatico di discesa • Insonorizzazione sicurezze • Avvisatore acustico fase finale discesa
-  Safety device in case of cable breakage • Overload safety-valve • Descent control valve • Safety-valve in case of sudden loss of pressure • "Dead man" controls 24V • Automatic release of safety locking devices • Automatic descent control • Soundproof safety devices • Buzzer on last portion of descent
-  Seilbruchsicherung • Überdrucksicherung • Sinkgeschwindigkeits-Regelventil • Rohrbruch-Sicherheitsventil • Totmann-Schaltung 24V • Elektrische Entriegelung der Sicherheitsrasten • Autom. Sicherheitsstop • Schalldaempfung Sicherheitshebel • Akustisches Signal Endphase Abstieg
-  Sécurité en cas de rupture d'un cable • Sécurité hydraulique en cas de surcharge • Vanne de contrôle descente • Vanne de sécurité en cas de rupture de tuyauterie • Commande de type "homme mort" 24V • Déverrouillage à commande électrique • Commande automatique de descente • Insonorisation sécurité • Signal sonore sur la dernière partie de la descente
-  Seguridad en caso de rotura cable • Seguridad hidráulica en caso de sobrecarga • Válvula de control velocidad descenso • Válvula de seguridad en caso de rotura del tubo hidráulico • Mandos de "hombre presente", 24V • Mando de desenganche eléctrico • Mando automático de descenso • Insonorización seguridades • Aviso acústico fase final de bajada

480

8,0 t

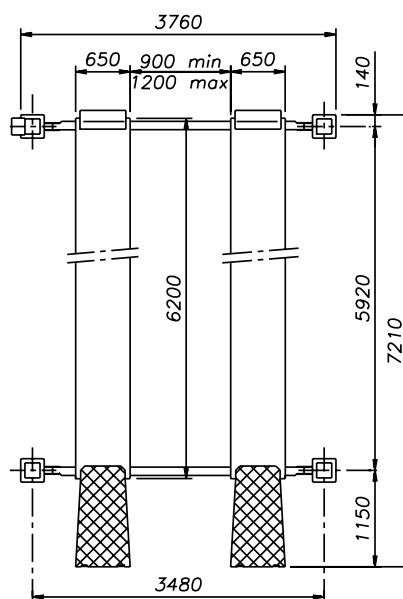
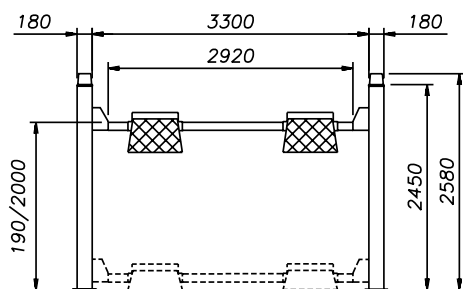

Dati tecnici

Technical data

Technische Eigenschaften

Caractéristiques techniques

Datos técnicos

Portata	Capacity	Tragfähigkeit	Capacité	Capacidad	8.000 kg
Peso	Weight	Gewicht	Poids	Peso	1900 kg
Salita/Discesa	Lifting/descent	Hub/Senkzeit	Levage/descente	Subida/Bajada	75 / 50 s
Altezza di sollevamento	Lifting height	Hubhöhe	Hauteur de levage	Altura de elevación	2000 mm
Motore	Motor	Motorleistung	Puissance moteur	Motor	3,0 kW - 3 ph 230 400V/50 Hz

Funzionamento: Elettroidraulico • **Function: Electro-hydraulic** • Funktionsweise: Elektrohydraulisch • Fonctionnement: Electrohydraulique • Funcionamiento: Electro-hidráulico



Opzioni

Optionals

Sonderzubehör

Options

Opcionales



Traversa idraulica ausiliaria (vedere scheda specifica)
Hydraulic jacking beam (see relevant data sheet)
 Hydraulischer Radfreiheber (s. eigenes Datenblatt)
 Levage auxiliaire hydraulique (voir fiche technique)
 Elevador hidráulico auxiliar (ver ficha técnica)

Esecuzione con motore monofase • Kit illuminazione • Carter protezione centralina

Single-phase motor • Illumination kit • Cover for control unit

Ausführung mit Einphasenmotor • Beleuchtungsset • Abdeckung für Hydraulikaggregat

Moteur monophasé • Kit d'éclairage • Carter protection centrale hydraulique

Motor monofásico • Kit de iluminación • Cubierta protectora para la centralita