

1. Join two straight Pipes together. (Fig. A)  
Then attach both end legs (Fig. B)

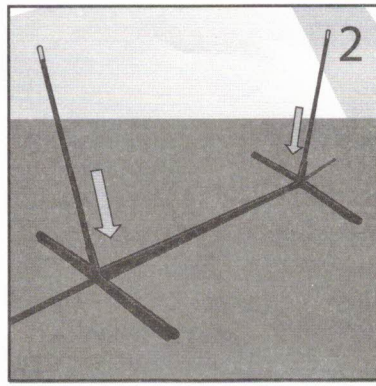

2. Install two lower Black Rods with Coupling Tubes up, into angled Pipes.

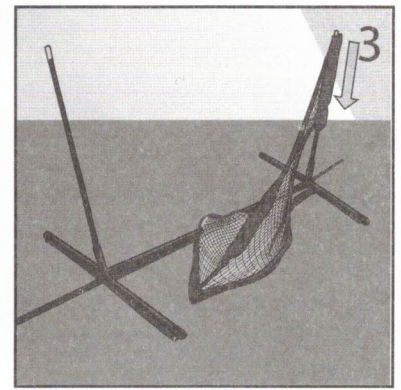

3. Thread Sleeve over Black Rod. Make sure logo is not upside down.



4. Repeat with Sleeve pocket over other Black Rod.

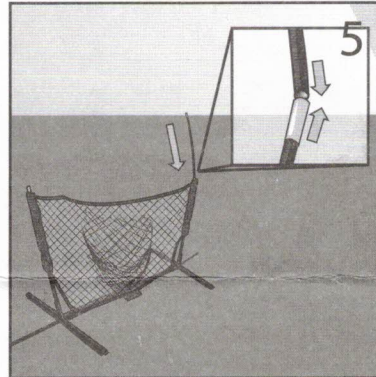

5. Take Black Rod and slide into lower rod's Coupling Tube.

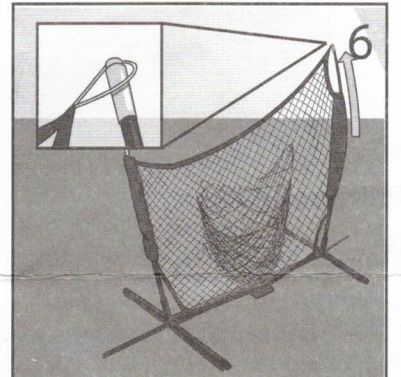

6. Hold Black Rod while pulling Sleeve up. Loop white cord over rod top.

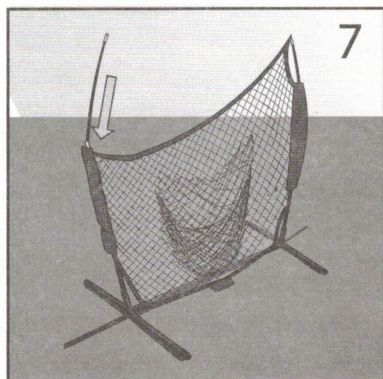

7. Take the last Black Rod and slide into Rod Coupling Tube.

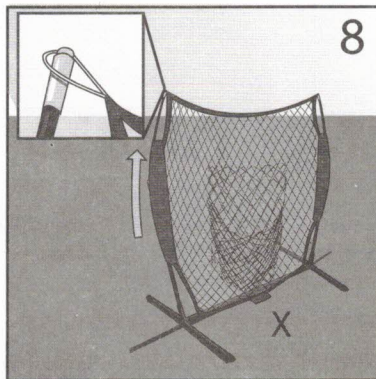

8. Grip Black Rod and pull Sleeve up. Loop Cord over pole top.

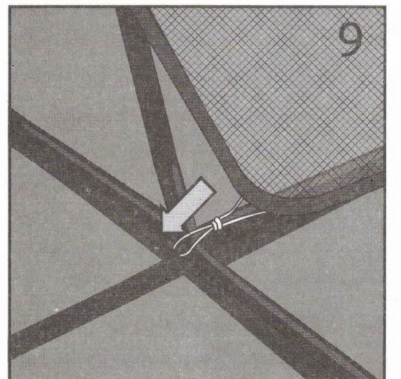

9. Take lower Elastic Loops and place under stud on both end legs.  
10. Wrap velcro around frame. (X in Fig. 8)