

Warranty Conditions

1. In case of any malfunction with normal usage and within the warranty period, we provide a replacement based on the condition stated on this warranty.
2. Bring this warranty card and invoice / receipt for services within the warranty period.
3. In case of sending item for replacement, the customer bears the shipping cost.
4. This warranty does not cover any damage of any appliances including but not limited to computer and the loss of data due to the USB connection to this product.
5. Warranty is not covered under the following circumstances:
 - (a) Lost or not presenting this warranty.
 - (b) The warranty card is not filled or falsification is found.
 - (c) Malfunction or damage caused by inappropriate usage, remodeling, or responsibility of the user.
 - (d) Malfunction or damage caused by natural disaster, such as fire, thunder, earthquake, flood, abnormal voltage, etc.
 - (e) Not for household use.
 - (f) Malfunction or damage caused by transportation or fall after purchase.
 - (g) The damage of accessory parts.
6. We do not reissue the warranty card, please keep it safe.
7. Warranty is only valid in Hong Kong.
8. After the end of the sale period, please note that replacement may not be possible even within the warranty period.

*When purchased at Francfranc online store and have no shop stamp, keep the invoice with the purchase date and bring it with this warranty card to enjoy the same warranty service.

Warranty

Product Name : 23 FRAIS MINI FAN

Purchase Date :

Name :

Address :

Telephone :

Email :

Shop Name / Shop Stamp

Warranty Period
6 Months
after purchase date

hk.francfranc.net

FRAIS MINI FAN

Instruction manual

Thank you for purchasing this product.

Please read this instruction manual carefully before use and use the product correctly. After reading, be sure to keep it and re-read it if you have any questions.

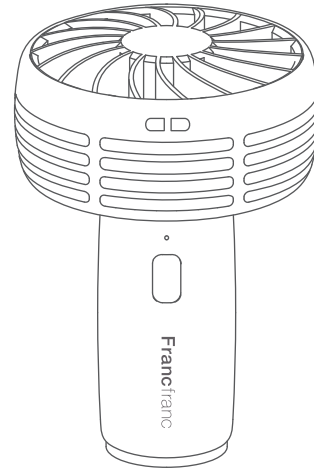

Warranty Included

⚠ Safety Notifications *Please read it for the safe usage.



In case of wrong handling might cause death, serious illness or disability.

- When abnormal condition such as smoke, having strange odor etc. during use, turn it off immediately or remove USB cable if it is being recharged to avoid fire or electric shock.
- Do not repair or remodel by yourself. It may cause fire or electric shock.
- Do not drop or give a strong shock or vibration. It may cause malfunction or damage. In case of any abnormality, stop using immediately.
- Do not use if it is damaged or malfunctioning. It may cause accidents.
- Do not modify, forcefully bend, twist or pull USB cable for charging. It may cause damage.
- When attaching or removing USB cable, hold the connector part. Otherwise may cause injury, accident or damage.
- If you feel something is wrong when inserting the USB cable, do not force it and contact the purchase store. If you forcibly insert it, it will become overheat and the USB plug may melt or deform, causing an electric shock or fire.
- Do not soak or splash water. Do not wash with water. It may cause electric shock, short circuit or fire.
- Do not touch with a wet hand. It may cause electric shock, malfunction or damage.
- Do not leave children to use it by themselves. It may cause injury, electric shock or accidents.
- Do not use or store in below places. It may cause fire, electric shock.
 - Near a fire source, such as heating appliances.
 - Under direct sunlight, inside closed car, etc. places could reach high temperature.
 - Places using organic solvents (paint, thinner, etc.) or gas.
 - Near humidifier.
 - Places with high humidity, such as bath room, kitchen, near washing machine.
 - Places reachable by infants or pets.



In case of wrong handling, it would cause human injury or objects damage.

- Avoid having dust or metal pieces attached on USB plug, micro USB plug or micro USB port. It may cause fire or over heating.
- Do not put anything on top of the USB cable while using it for charging. It may cause fire, malfunction or damage.
- Do not leave it recharging.
- When fully recharged, remove the body from the charging cable.
- Do not cover over by fabric. It may cause injury, malfunction or damage.
- Do not let hairs or strings near the product. It may be strangled and cause injury.
- To avoid falling, only clip it on things with thickness between 5~10mm.
- Do not blow the wind continuously for a long period of time. It may damage the health.
- When cleaning, avoid using benzine, thinner, alcohol, etc. containing volatile organic solvent. It may cause discoloration, deformation or damage.



If you find any other abnormality, over heating, smoke, odor or strange noise, etc. stop using immediately. And please contact the purchase store or our company.

Disposing the product



Only disassemble in case of disposal.



This product uses lithium ion battery. Avoid disposing it and recycle the battery.

Parts Description

▪ Body(Antibacterial)

【Front】

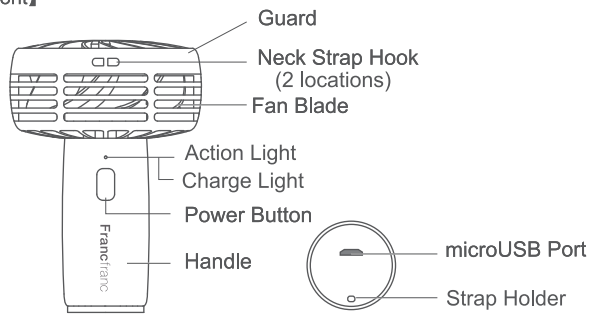

▪ Fixing Clip(Antibacterial)

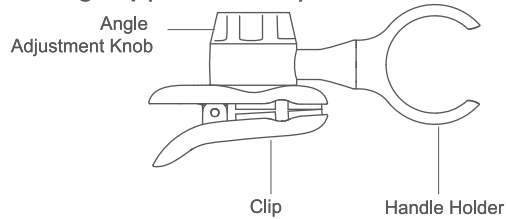

▪ Charging USB Cable

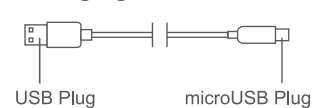

▪ Neck Strap Hook

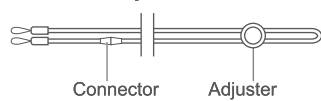

Charging Method

1. Connect USB plug of the charging USB cable to USB port or output port of USB-AC adapter, mobile battery(sold separately).
2. Plug in microUSB plug of the charging USB cable to microUSB port of the charging stand.
3. During charging, the charging indicator light will flash white; after charging, the light will go out.
4. When fully charged, remove the body from the charging stand.

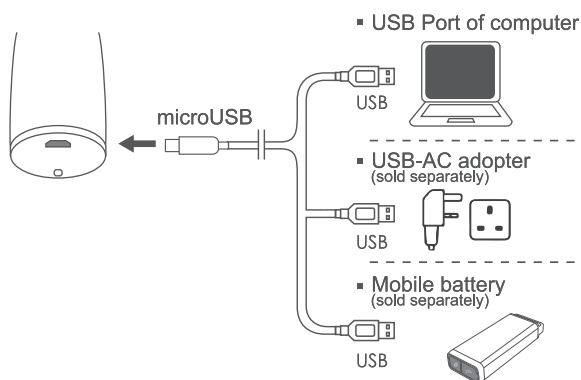

⚠ Attention

- Do not forcibly insert the connector, as it may cause damage.
- Be sure to use the FRAIS MINI FAN USB power cable.

Lithium Ion Battery

- Battery cannot be replaced.
- Charge cycle is approx. 300 times. The length of time usable when fully charged gradually reduce.
- Recharging the battery with nearly full charged status could reduce the battery life.
- Leaving battery not charged for a long period of time would shorten the battery life. Charge the battery **approximately 50% once a month.**

Using Method

Fully charged before the first time usage.

▪Starting Power - ON

Press and hold the power button until the operation indicator lights up, and it will start to work.

▪Shutting Down - OFF

During operation, **long press** the power button to turn off the power.

▪Adjust the Wind Speed

Change the wind speed (3 levels) by pressing the power button.

↳ Weak → Medium → Strong ↵

▪ Neck Strap Hook Usage

1. Open the connector on the attached neck strap, and fix the neck strap through the neck strap hooks on both sides.
2. After closing the connector, it can be used on the neck.



▪ Fixing Clip Usage

- Referring to 【Figure 1】 Turn the angle adjustment knob in the direction of arrow ①. Follow the direction of the other arrow, adjust the angle of the handle holder, and then turn the angle adjustment knob in the reverse direction to lock.
- Insert the handle of the body into the handle holder and fix it. Be sure to insert vertically from the bottom of the body to the handle, as shown in Figure 2. Do not insert from the side of the main body, as this may damage the handle holder.
- The fixing clip can be installed in umbrellas, laptops, strollers, etc. Please refer to 【Figure 3】 to adjust the angle of the fixed position of the handle.

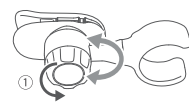

【 Figure2 】

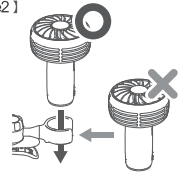

【 Figure3 】

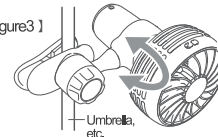

⚠ Attention

- Please clip it to an object with a thickness of 5 ~ 10mm, and make sure that the fixed clip is inserted to the deepest position.
- Since it is difficult to fix the clip to a soft or smooth object, before turning on the power, please make sure the fan is fixed. Do not use in an unfixed state.
- Do not forcibly bend, pressurize, etc. to avoid damage.
- Take care to avoid pinching your fingers.
- The company is not responsible for the direct or indirect damage caused by the use of the fixing clip.

Maintenance Method

1. Make sure the power is off.

Do not apply any maintenance while charging battery.

2. Use a fabric with neutral detergent diluted with water and wipe off to clean.

* Do not use volatile organic solvent, such as thinner, alcohol, etc. It may cause deformation or malfunction.

Specification

Input Voltage : DC 5V 800mA

Rechargeable Battery : Lithium Ion Battery

Charging time : Approx. 1 hours 45 minutes

Continued usage time : Approx. 1 hour 20 minutes ~ 4 hours

Size : Approx. 60x60x85mm

Weight : Approx. 61g (Body only)

Material : ABS (Body, Blade)

Set includes : Body, Dedicated fixing clip, Neck strap,

Charging USB Cable, Instruction manual

Antibacterial Parts: Body, Dedicated fixing clip

*Charging time may require extremely longer if the power supply capacity is low.

*Usable time vary depends on the wind power.

*The antibacterial effect does not last permanently, and not effective for all types of bacteria.

*The fan blade has no antibacterial effect.