

Warranty Conditions

1. In case of any malfunction with normal usage and within the warranty period, we provide a replacement based on the condition stated on this warranty.
2. Bring this warranty card and invoice / receipt for services within the warranty period.
3. In case of sending item for replacement, the customer bears the shipping cost.
4. This warranty does not cover any damage of any appliances including but not limited to computer and the loss of data due to the USB connection to this product.
5. Warranty is not covered under the following circumstances:
 - (a) Lost or not presenting this warranty.
 - (b) The warranty card is not filled or falsification is found.
 - (c) Malfunction or damage caused by inappropriate usage, remodeling, or responsibility of the user.
 - (d) Malfunction or damage caused by natural disaster, such as fire, thunder, earthquake, flood, abnormal voltage, etc.
 - (e) Not for household use.
 - (f) Malfunction or damage caused by transportation or fall after purchase.
 - (g) The damage of accessory parts.
6. We do not reissue the warranty card, please keep it safe.
7. Warranty is only valid in Hong Kong.
8. After the end of the sale period, please note that replacement may not be possible even within the warranty period.

*When purchased at Francfranc online store and have no shop stamp, keep the invoice with the purchase date and bring it with this warranty card to enjoy the same warranty service.

Warranty

Product Name : 23 FRAIS HANDY FAN

Purchase Date :

Name :

Address :

Telephone :

Email :

Shop Name / Shop Stamp

Warranty Period
6 Months
after purchase date

hk.francfranc.net

FRAIS HANDY FAN

Instruction manual

Thank you for purchasing this product.

Please read this instruction manual carefully before use and use the product correctly. After reading, be sure to keep it and re-read it if you have any questions.

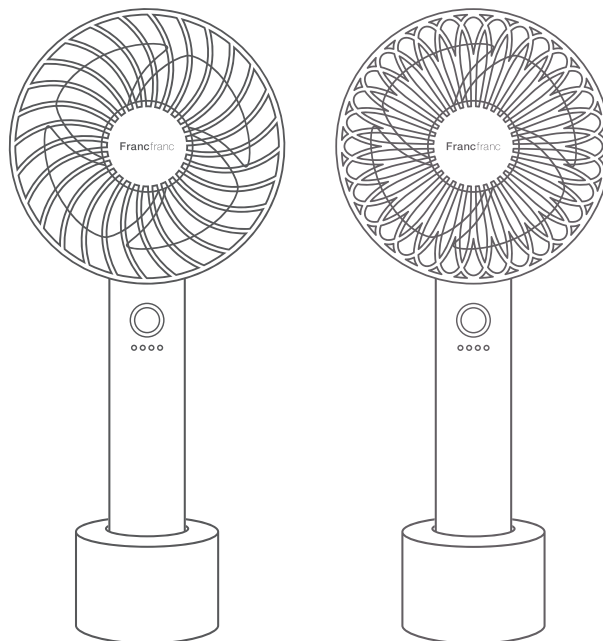

FRAIS HANDY FAN AURORA and GRADATION may have a unique processing smell, but there is no problem with the product itself. Also, the smell will disappear over time.

Warranty Included

Safety Notifications *Please read it for the safe usage.



In case of wrong handling might cause death, serious illness or disability.

- When abnormal condition such as smoke, having strange odor etc. during use, turn it off immediately or remove USB cable if it is being recharged to avoid fire or electric shock.
- Do not repair or remodel by yourself. It may cause fire or electric shock.
- Do not drop or give a strong shock or vibration. It may cause malfunction or damage. In case of any abnormality, stop using immediately.
- Do not use if it is damaged or malfunctioning. It may cause accidents.
- Do not put finger, needle, pin, etc. in the gap of the cover. In case of any object inside, turn it off and contact our company. Using it with objects inside may cause electric shock, injury or damage of the product.
- Do not modify, forcefully bend, twist or pull USB cable for charging. It may cause damage.
- When attaching or removing USB cable, hold the connector part. Otherwise may cause injury, accident or damage.
- If you feel something is wrong when inserting the USB cable, do not force it and contact the purchase store. If you forcibly insert it, it will become overheat and the USB plug may melt or deform, causing an electric shock or fire.
- Do not soak or splash water. Do not wash with water. It may cause electric shock, short circuit or fire.
- Do not touch with a wet hand. It may cause electric shock, malfunction or damage.
- Do not leave children to use it by themselves. It may cause injury, electric shock or accidents.
- Do not use or store in below places. It may cause fire, electric shock.
 - Near a fire source, such as heating appliances.
 - Under direct sunlight, inside closed car, etc. places could reach high temperature.
 - Places using organic solvents (paint, thinner, etc.) or gas.
 - Near humidifier.
 - Places with high humidity, such as bath room, kitchen, near washing machine.
 - Places reachable by infants or pets.



In case of wrong handling, it would cause human injury or objects damage.

- Avoid having dust or metal pieces attached on USB input port, USB or microUSB plug on USB cable. It may cause fire or over heating.
- Do not put anything on top of the USB cable while using it for charging. It may cause fire, malfunction or damage.
- In case of using recharging stand, use it on flat and stable place.
- Do not leave it recharging or use near inflammables.
- When fully recharged, remove the body from the charging cable or the rechargeable stand.
- Do not cover by fabric. It may cause injury, malfunction or damage.
- Do not put hairs or strings near the product. It may be strangled and cause injury.
- Do not blow the wind against human or animal continuously for a long period of time. It may damage the health.
- When cleaning, avoid using benzene, thinner, alcohol, etc. containing volatile organic solvent. It may cause discoloration, deformation or damage.



If you find any other abnormality, over heating, smoke, odor or strange noise, etc. stop using immediately. And please contact the purchase store or our company.

Disposing the product



Only disassemble in case of disposal.



This product uses lithium ion battery. Avoid disposing it and recycle the battery.

Parts Description

■ Body (Antibacterial)

[STANDARD]

[FLOWER]

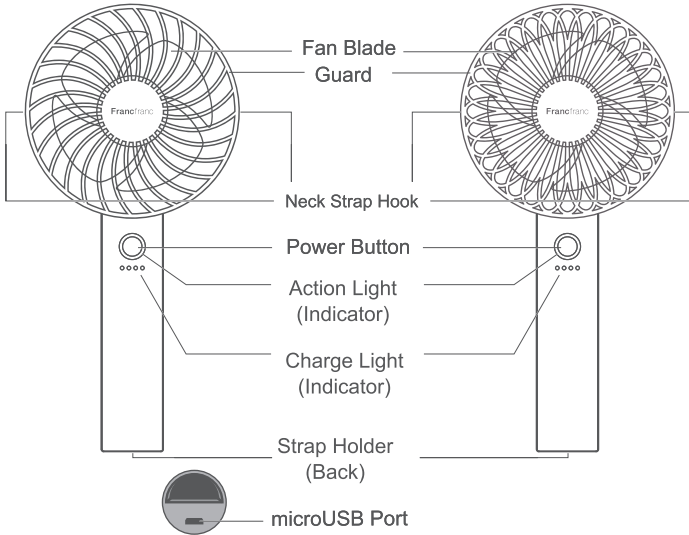

■ Rechargeable Stand (Antibacterial)

[Front]

[Back]

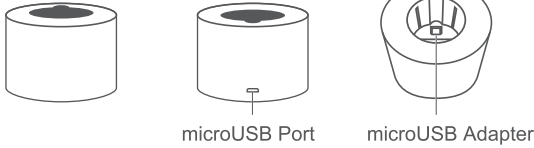

■ Charging USB Cable

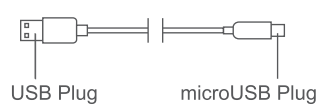

■ Strap

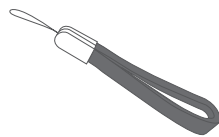

Using Method

Fully charged before the first time usage.

Press Power button to start and the action indicator light is lit.

• Change the wind speed (5 levels + Rhythm) by pressing the power button.

Min. → Weak → Medium → Strong → Max. → Rhythm → OFF

• If you press and hold the power button during operation, you can turn it off at any time regardless of the wind speed.

■ Neck Strap Hook

Please pass the neck strap completely through the hook to ensure that it is stable before use.

[STANDARD]

[FLOWER]

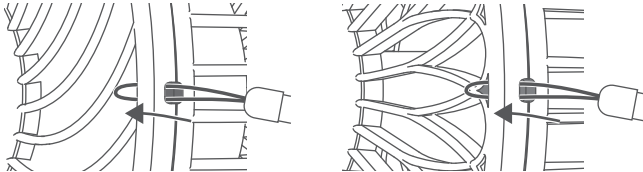

Indicator Display

[Rhythm Wind]



After the action light flashes for 3 seconds, the light keeps on.

[Battery]

● ● ● ●	75~100% remain
● ● ● ○	50~75% remain
● ● ○ ○	25~50% remain
● ○ ○ ○	~25% remain

[Charging]

☀ ○ ○ ○	~25% charged
● ☀ ○ ○	25~50% charged
● ● ☀ ○	50~75% charged
● ● ● ☀	75~100% Charged
● ● ● ●	Fully Charged

Maintenance Method

1. Make sure the power is off. Do not apply any maintenance while charging battery.
2. Use a fabric with neutral detergent diluted with water and wipe off to clean.

* Do not use volatile organic solvent, such as thinner, alcohol, etc. It may cause deformation or malfunction.

Charging Method

■ Using charging stand

1. Connect USB plug of the charging USB cable to USB port or output port of USB-AC adaptor, mobile battery (sold separately).
2. Plug in microUSB plug of the charging USB cable to microUSB port of the charging stand.

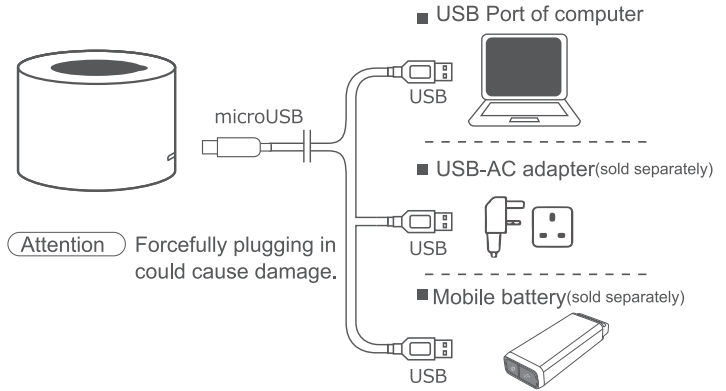

Attention Forcefully plugging in could cause damage.

3. Connect microUSB port of the body and microUSB stand of the charging stand to start charging.

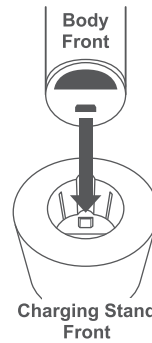

⚠ Attention

- To prevent damage to the microUSB port and microUSB plug, align the front of the main unit with the front of the dedicated charging stand and set it all the way in. Charging will not start if the unit is set in the opposite direction.
- The strap can be attached while setting on the charging stand.

4. When fully charged, remove the body from the charging stand.

■ Not using charging stand

1. Connect USB plug of the charging USB cable to USB port or output port of USB-AC adaptor, mobile battery.
2. Plug in micro USB plug of USB cable to microUSB port of the bottom of the body.
3. When fully charged, remove the charging cable from the body.

■ Lithium Ion Battery

- Battery cannot be replaced.
- Charge cycle is approx. 300 times. The length of time usable when fully charged gradually reduce.
- Recharge after discharging a certain capacity of the battery.
- Recharging the battery with nearly full charged status could reduce the battery life.
- Leaving battery not charged for a long period of time would shorten the battery life. Charge the battery approximately 50% once a month.

Specification

Input Voltage : DC 5V 1000mA (USB Rechargeable)

Rechargeable Battery : Lithium Ion Battery

Charging time : Approx. 4 hours

Continued usage time : Approx. 2 ~ 9 hours

Size : Approx. 103x218x37mm

Weight : Approx. 178g (Body only) 183g (GRADATION)

Material : ABS (Body) / PP (Blade), PC, ABS (Body) / PP (Wings) (GRADATION)

Set includes : Body, Charging Stand, Charging USB Cable,

Strap, Instruction manual

Antibacterial Parts: Body, Charging Stand

*Charging time may require extremely longer if the power supply capacity is low.

*Usable time vary depends on the wind power.

*The antibacterial effect does not last permanently, and not effective for all types of bacteria.

*The fan blade has no antibacterial effect.

*AURORA and GRADATION design are not antibacterial.

*MARBLE design products have individual differences in the marble pattern.

*Products with AURORA and GRADATION designs have individual differences in aurora and gradation pattern.