



INSTRUMENTS

GX-Force

Operator's Manual

Part Number: 71-0626

Revision: P3

Released: 9/21/23

RKI Instruments, Inc.
www.rkiinstruments.com

WARNING

Read and understand this instruction manual before operating instrument. Improper use of the gas monitor could result in bodily harm or death.

Maintenance of the gas monitor is essential for proper operation and correct readings.

Bump test the instrument before each day's use with a known concentration of each target gas. A bump test can be done in User Mode's BUMP item or by applying gas in Measuring Mode. The instrument does not need to be calibrated unless it does not pass the User Mode bump test or does not respond appropriately, as defined by the user, in Measuring Mode. For more information about bump test and calibration requirements, see IEC 60079-29-2.

GX-Force Quick Reference Guide

Turn On

Press & Hold

**POWER
MODE**

Past Due Bump/CAL

To Bump / CAL

**POWER
MODE**

Confirm & Use

AIR

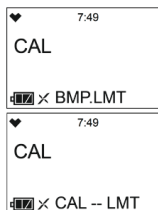

Normal Operation

After brief
warm-up period



Fresh Air

Press & Hold

AIR

Turn Off

Press & Hold

**POWER
MODE**

GX-Force Quick Reference Guide

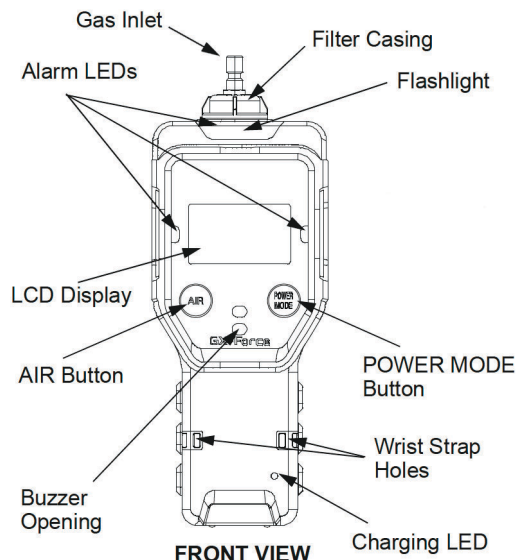

Scan QR code for
GX-Force Manual

RKI Instruments, Inc. 33248 Central Ave, Union City, CA 94587
Phone (510) 441-5656 • (800) 754-5165 • www.rkiinstruments.com
230913/10000



Statement of Quality and Conformance

RKI Instruments, Inc. certifies that this instrument has been tested, inspected, and calibrated by a qualified technician and was found to meet or exceed the manufacturer's specifications per ISO 9001 Quality System.

Register your Product here:

www.rkiinstruments.com/registration

RKI Instruments, Inc. • 33248 Central Avenue, Union City, CA 94587
Phone: (510) 441-5656 • (800) 754-5165 • Fax: (510) 441-5650
www.rkiinstruments.com

Table of Contents

Chapter 1: Introduction	9
Overview	9
About the GX-Force	9
Specifications	10
About this Manual	12
Chapter 2: Description	13
Overview	13
Instrument Description	13
<i>Case</i>	13
<i>LCD</i>	14
<i>Control Buttons</i>	14
<i>Alarm LEDs</i>	14
<i>Buzzer</i>	15
<i>Vibrator</i>	15
<i>Printed Circuit Boards (PCBs)</i>	15
<i>Pump</i>	14
<i>Control Buttons</i>	14
<i>Sensors</i>	15
<i>Filters</i>	16
<i>USB Type-C Charging Data Port</i>	17
Included Accessories	18
<i>Tapered Rubber Nozzle</i>	18
<i>Belt Clip</i>	18
<i>USB Type-A to Type-C Cable</i>	18
Optional Accessories	19
<i>AC Adapter Cable</i>	19
<i>Sample Hose & 8 Inch Probe</i>	19
<i>External Dilution Fitting</i>	17

Chapter 3: Operation	21
Overview	21
Start Up	21
<i>Turning On the GX-Force</i>	21
<i>Performing a Demand Zero</i>	27
<i>Turning Off the GX-Force</i>	28
Measuring Mode Operation	29
<i>Confirmation/Non-Compliance Indicator</i>	29
<i>Monitoring an Area</i>	30
<i>Combustible Gas Detection</i>	30
<i>Oxygen-Enriched Atmospheres</i>	32
<i>H₂-Compensated CO Detection</i>	33
<i>Interference Information</i>	33
Alarms	33
<i>Alarm Indications</i>	33
<i>Responding to Alarms</i>	36
Saving Snap Log Data	42
Data Logging	43
Chapter 4: Display Mode	44
Tips for Using Display Mode	45
LED Flashlight (LIGHT)	46
Peak Screen (PEAK)	46
STEL Screen (STEL)	47
TWA Screen (TWA)	47
Combustible Sensor Target Gas Conversion (LIST)	47
Turning the Pump Off (PUMP.OFF)	50
Changing the User ID (USER ID)	51
Changing the Station ID (STN ID)	52
Last Successful Calibration Date (CAL DATA)	53
Last Successful Bump Test Date (BMP.DATA)	54
Viewing Snap Log Data (REC.DATA)	55
Date, Time, and Temperature Screen (TEMP)	55
Viewing Alarm Settings Screen (ALARM - - P)	56

Chapter 5: User Mode and Calibration	58
Overview	58
Tips for Using User Mode	62
Entering User Mode	63
Performing a Bump Test (BUMP)	63
Performing a Calibration (GAS CAL)	70
Setting Calibration Parameters (CAL SET)	81
Setting Bump Test Parameters (BUMP.SET)	83
Alarm Settings (ALARM - - P)	87
Updating the Lunch Break Setting (LUNCH)	90
Setting the Confirmation Beep and Non-Compliance Indicator (BEEP)	91
Updating the Backlight Time (BL TIME)	93
Turning the Key Tone On/Off (KEY.TONE)	93
Display Mode Items (DISP.SET)	94
Zero Suppression (ZERO.SUP)	94
Zero Follower (ZERO.FLW)	94
Setting the Date/Time (DATE)	95
Turning the Password On/Off (PASS - - W)	95
Viewing the ROM/SUM (ROM/SUM)	96
Entering Measuring Mode (START)	97
Chapter 6: Maintenance	98
Overview	98
Troubleshooting	98
Instrument Cleaning	99
Recharging the Battery Pack	99
Replacing the Sensor Filters	100
<i>Combustible Gas Sensor Filter</i>	100
<i>Dual CO/H₂S Sensor Filter</i>	100
<i>CO-Only/H₂-Compensated CO Sensor Filter</i>	100
<i>H₂S-Only Sensor Filter</i>	100
Replacing the Inlet Filters	102
Replacing the Probe Filters	104
Replacing a Sensor	105

Chapter 7: Storage	107
Chapter 8: General Parts List	108
Appendix A: Maintenance Mode	110
Overview	110
Tips for Using Maintenance Mode	112
Entering Maintenance Mode	113
Performing a Calibration (GAS CAL)	114
Performing a Gas Test (GAS TEST).....	114
Sensor/Battery Replacement Date (SEN.DATE)	115
Performing a Bump Test (BUMP)	116
Setting Alarms to Latching or Self-Resetting (LATCH)	117
Turning the Alarm Silence Function On/Off (ALM.SNC).....	118
Turning the Demand Zero Function On/Off (D.ZERO).....	118
Turning the Auto Zero Function On/Off (A.ZERO).....	118
Turning the ID Display Function On/Off (ID DISP)	119
Turning the Zero Suppression On/Off (ZERO.SUP)	119
Turning the Zero Follower On/Off (ZERO.FLW)	119
User Mode Zero Suppression (ZSUP.DISP).....	120
User Mode Zero Follower (ZFLW.DISP).....	120
Turning the Pump Off Display On/Off (POFF.DSP)	120
Setting the Date/Time (DATE)	120
Turning the Password On/Off (PASS - - W).....	121
Viewing the ROM/SUM (ROM/SUM).....	122
Performing a Flow Adjustment (FLOW.ADJ)	122
Performing a Default (M.DEFAULT).....	122
Entering Measuring Mode (START)	123
Appendix B: Gas Select Mode	124
Overview.....	124
Tips for Using Gas Select Mode.....	124
Entering Gas Select Mode	125
Changing the Gas Combination (GAS.COMB).....	126
Saving the Alarm Points (SAVE-AP).....	129

Turning Calibration Max Span On/Off (MAX.SPAN).....	130
Stealth and Vibrator Settings (STEALTH).....	130
LEL Definition (CHG LEL).....	131
Exiting Gas Select Mode (START).....	133

Appendix C: Interference Information 134

ESR-A13i-H2S, H ₂ S Detection	134
ESR-A13P-CO, CO Detection	136
ESR-A1CP-COH, H ₂ -Compensated CO Detection	138
ESR-A1DP-COHS, CO Detection	140
ESR-A1DP-COHS, H ₂ S Detection.....	142

WARNING: Understand manual before operating. Substitution of components may impair intrinsic safety. To prevent ignition of a hazardous atmosphere, batteries must only be changed or charged in an area known to be nonhazardous.

Chapter 1: Introduction

Overview

This chapter briefly describes the GX-Force portable gas monitor. This chapter also describes the *GX-Force Operator's Manual* (this document). Table 1 at the end of this chapter lists the specifications for the GX-Force.

About the GX-Force

Using an advanced detection system consisting of up to three gas sensors, the GX-Force personal four-gas monitor detects the presence of combustible gas, oxygen (O₂), carbon monoxide (CO), and hydrogen sulfide (H₂S) simultaneously. The GX-Force's compact size and easy-to-use design make it ideally suited for a wide range of applications, including sewage treatment plants, utility manholes, tunnels, hazardous waste sites, power stations, petrochemical refineries, mines, paper mills, drilling rigs, and fire fighting stations. The GX-Force offers a full range of features, including:

- Simultaneous monitoring of one to four gases
- Liquid crystal display (LCD) for complete and understandable information at a glance
- Ultrabright alarm LEDs
- Distinctive audible/vibrating alarms for dangerous gas conditions and audible alarms for unit malfunction
- Microprocessor control for reliability, ease of use, and advanced capabilities
- Data logging functions
- Alarm trend data
- STEL, TWA, and over range alarms
- Peak readings
- Built-in time function
- Lunch break feature
- CSA "C/US" classified as intrinsically safe (pending, see page 11)

WARNING: The Model GX-Force detects oxygen deficiency, elevated levels of oxygen, combustible gases, carbon monoxide, and hydrogen sulfide, all of which can be dangerous or life threatening. When using the GX-Force, you must follow the instructions and warnings in this manual to assure proper and safe operation of the unit and to minimize the risk of personal injury. Be sure to maintain and periodically calibrate the GX-Force as described in this manual.

Specifications

Table 1: Standard Sensor Specifications/Alarm Points



	Combustible Gas, Methane (CH ₄) Calibration Standard*	Oxygen (O ₂)	Hydrogen Sulfide (H ₂ S)	Carbon Monoxide (CO)
Detection Range	0 - 100% LEL	0 - 40% volume	0 - 200.0 ppm	0 - 2,000 ppm
Lowest Detectable Limit (LDL)	n/a	n/a	0.5 ppm	3 ppm
Reading Increment	1% LEL	0.1% volume	0.1 ppm	1 ppm
Warning Setpoint	10% LEL	19.5% volume, decreasing	5.0 ppm	25 ppm
Alarm Setpoint	25% LEL	18.0% volume, decreasing	30.0 ppm	50 ppm
Alarm H Setpoint	50% LEL	23.5% volume, increasing	100.0 ppm	1200 ppm
STEL Setpoint	n/a	n/a	5.0 ppm	200 ppm
TWA Setpoint	n/a	n/a	1.0 ppm	25 ppm

* The GX-Force is also available set up for general hydrocarbons and calibrated to a combustible gas other than methane, such as isobutane. Consult RKI Instruments, Inc. for further information.

Table 2: GX-Force Specifications

Sampling Method	Sample Draw
Response Time	T90 within 30 seconds
Display	Graphics LCD Display
Environmental Conditions	<ul style="list-style-type: none"> Operating pressure: 80 - 120 kPa (80 - 110 kPa for explosion-proof classification) IP 67
Operating Temperature & Humidity	<p>Continuous environment: -20°C to 50°C/Below 90% RH</p> <p>Temporary environment (up to 15 minutes): -20°C to 60°C/Below 95% RH</p> <p>Ambient temperature range (for charging): 10°C to 40°C</p> <p><i>NOTE: The H₂-compensated CO sensor may not effectively compensate for higher levels of H₂ if exposed to temperatures above 40°C for longer than 15 minutes. Under these conditions, it can appear to the instrument that the H₂ concentration has exceeded 2000 ppm, the max concentration that can be compensated for, resulting in a CO reading higher than the actual CO level.</i></p>

Table 2: GX-Force Specifications

<p>Safety/ Regulatory</p>	<ul style="list-style-type: none"> • ATEX: Certificate Number: DNV 22 ATEX 05201X IIIG Ex da ia IIC T4 Ga (with NCR-6309) IIIG Ex ia IIC T4 Ga (without NCR-6309) • IECEx: Certificate Number: IECEx DNV 22.0029X Ex da ia IIC T4 Ga (with NCR-6309) Ex ia IIC T4 Ga (without NCR-6309) <div style="text-align: center;">  </div> <ul style="list-style-type: none"> • PENDING: CSA classified, “C/US”, as Intrinsically Safe. Class I Division 1 Groups A, B, C, D T4. Class I, Zones 0, A/Ex da ia IIC T4 Ga (with NCR-6309) Class I, Zones 0, A/Ex ia IIC T4 Ga (without NCR-6309) <div style="text-align: center;">  C US 186718 </div>
<p>Power Supply</p>	<p>Lithium ion battery pack (3.6V, 300 mA)</p>
<p>Continuous Operating Hours @ 25 °C</p>	<p>30 hours (non-alarm operation)</p>
<p>Battery Charger</p>	<p>Input: 100 - 240 VAC, 50/60 Hz, 0.6 A Output: 5.0 VDC, 3 A max Estimated Charge Time: 8 hours</p>
<p>Case</p>	<p>High-impact Plastic, RF-Shielded, Dust and Water Proof (IP 67)</p>
<p>Included Accessories</p>	<ul style="list-style-type: none"> • Belt clip • Tapered rubber nozzle • USB Type-C data cable
<p>Optional Accessories</p>	<ul style="list-style-type: none"> • AC adapter • 12 VDC adapter • 10 foot hose and probe • Hose/Probes of various lengths, see “Chapter 8: General Parts List” on page 108 • Dilution Fitting (1:1) • Data Logger Management Program
<p>Dimensions and Weight</p>	<p>Approximately 173(H) x 64(W) x 47(D) mm (6.8” H x 2.5” W x 1.9” D) Approximately 280 g (9.9 oz.)</p>

About this Manual

The *GX-Force Operator's Manual* uses the following conventions for notes, cautions, and warnings.

NOTE: Describes additional or critical information.

CAUTION: *Describes potential damage to equipment.*

WARNING: *Describes potential danger that can result in injury or death.*

Chapter 2: Description

Overview

This chapter describes the GX-Force instrument and its accessories.

Instrument Description

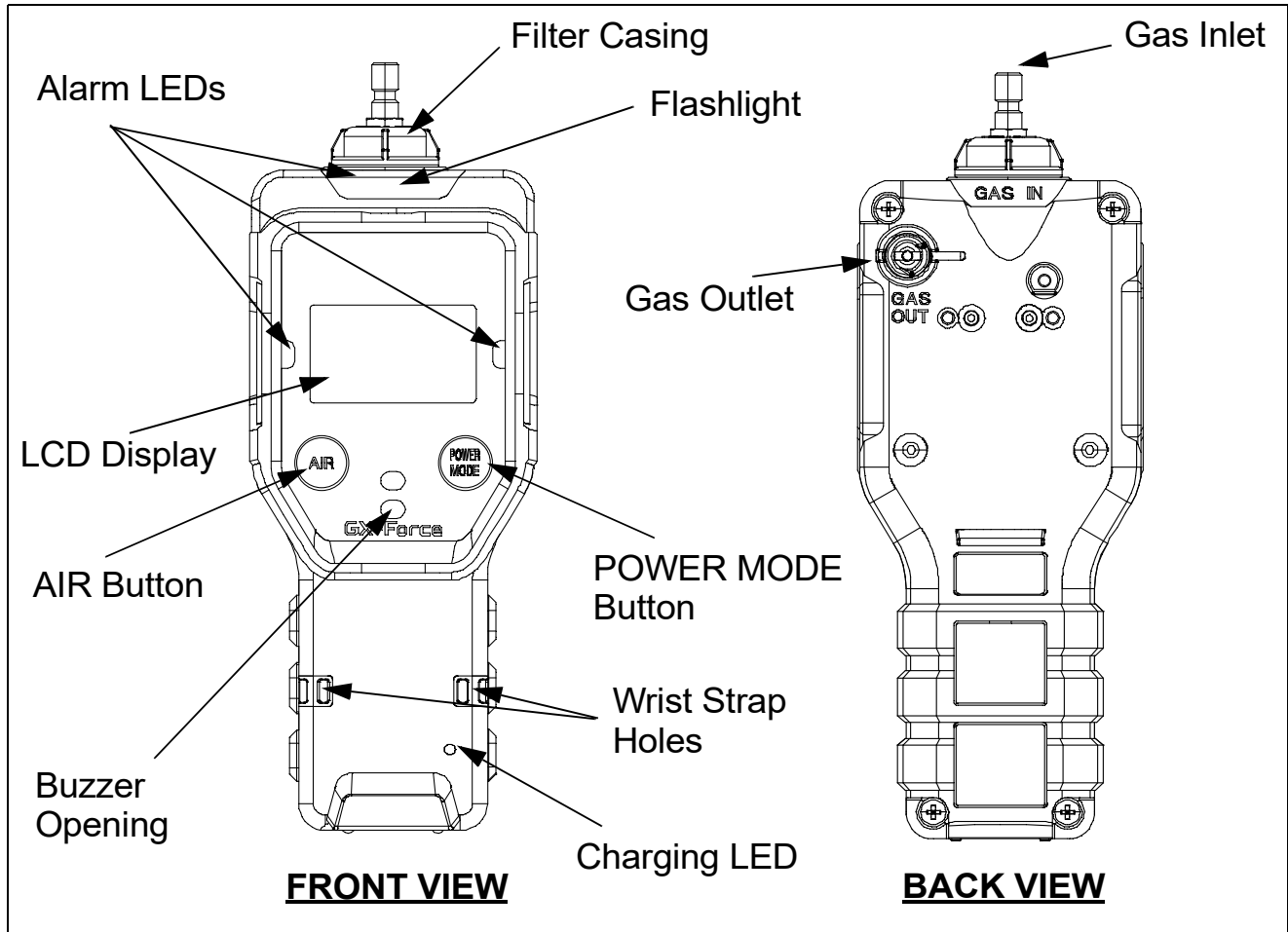

Figure 1: Component Location

Case

The GX-Force's sturdy, high-impact plastic case is radio frequency (RF) resistant and suitable for use in many environmental conditions, indoors and out. The case is dust-proof and water-resistant. A clear plastic window on the front of the case allows for LCD viewing.

Four screws in each corner of the back case allow access to the sensors and filters. Three threaded inserts on the back of the case allow for installation of a belt clip.

LCD

The digital LCD (liquid crystal display) simultaneously shows the gas reading for all installed sensors. The LCD also shows information for each of the GX-Force's operating modes.

WARNING: *A thin protective film covers the display to prevent scratches during shipping. Remove this film before use. Leaving the film installed voids the intrinsically safe certification.*

Control Buttons

Two control buttons, AIR and POWER MODE, are located below the LCD.

Table 3: GX-Force Control Button Functions

Button	Function(s)
AIR	<ul style="list-style-type: none">• turns on LCD backlight• resets alarm condition if LATCH is set to ON in Maintenance Mode• enters User Mode, Maintenance Mode, and Gas Select Mode when used with POWER MODE button• activates the demand zero function (adjusts the GX-Force's fresh air reading)• changes the value of a parameter available for adjustment• scrolls through parameter options
POWER MODE	<ul style="list-style-type: none">• turns the GX-Force on and off• turns on LCD backlight• enters and scrolls through Display Mode• enters instructions into the GX-Force's microprocessor• resets alarm condition if LATCH is set to ON in Maintenance Mode• enters User Mode, Maintenance Mode, and Gas Select Mode when used with AIR button

Flashlight LED

A white LED is visible through a round, raised, frosted lens in the top of the case. This LED can be used to provide extra light, if necessary. The flashlight can be activated in the Display Mode. See page 46 for activating and deactivating the flashlight LED.

Alarm LEDs

The six alarm LEDs around the edge of the case alert you to gas, low battery, and failure alarms.

Charging Indicator LED

One LED located near the bottom of the instrument lights up green when a power cable is plugged into the instrument's charging/data port. The LED changes to orange as charging begins. When charging is complete, the LED turns green until the instrument is disconnected from power.

Buzzer

One solid-state electronic buzzer is located inside the case. Sound exits the case through a hole in the middle front of the case. The buzzer sounds for gas alarms, malfunctions, low battery voltage, and as an indicator during use of the GX-Force's many display and adjustment options.

Vibrator

A vibrating motor inside the GX-Force case vibrates for gas alarms, unit malfunctions, and as an indicator during normal use of the various modes of the GX-Force.

NOTE: If **STEALTH** is set to **ON**, the vibrator only functions when **VIB** in the **STEALTH** Gas Select Mode item is set to **ON**. See "Stealth and Vibrator Settings (STEALTH)" on page 130.

Printed Circuit Boards (PCBs)

The GX-Force's printed circuit boards analyze, record, control, store, and display the information collected. The circuit boards are located inside the case. They are not user serviceable.

Pump

A diaphragm pump inside the GX-Force draws the sample to the sensors. It can draw sample from as far as 100 feet from the GX-Force. The pump is not user serviceable.

CAUTION: *Sample hose lengths of more than 100 feet are not recommended for the GX-Force because of flow rate reduction.*

Flow Chamber

The flow chamber is on the back of the GX-Force and is held in place by four Phillips screws. The flow chamber seals to the rubber sensor gasket which seals to the sensor faces inside the GX-Force and routes flow from the pump to the sensors and to the exhaust port (on the back of the GX-Force case).

Sensors

The GX-Force uses three sensors to monitor combustible gas, oxygen (O₂), carbon monoxide (CO), and hydrogen sulfide (H₂S) simultaneously. The sensors are located inside the GX-Force and are held in their sockets by the sensor retainer and back case. The sensors use different detection principles, described in the following sections.

Combustible Gas Sensor

The combustible gas sensor (NCR-6309) detects combustible gas in the %LEL range using 2 catalytic elements: a standard element and a poison-resistant element that is resistant to sensor poisons like silicone. The element's electrical resistance changes based on the reaction of gas with oxygen. The change in resistance affects the current flowing through the element. The GX-Force's circuitry amplifies the current, converts the current to a gas concentration, and displays the concentration on the LCD.

The standard calibration for the combustible gas sensor is to methane, but the sensor will still detect and respond to a variety of combustible gases.

O₂/CO/H₂S Sensors

The O₂, CO, and H₂S sensors are electrochemical cells that consist of two precious metal electrodes in a dilute acid electrolyte. A gas permeable membrane covers the sensor face and allows gas to diffuse into the electrolyte. The gas reacts in the sensor and produces a current proportional to the concentration of the target gas. The GX-Force's circuitry amplifies the current, converts the current to a gas concentration, and displays the concentration on the LCD.

There are 4 different types of CO and H₂S sensors available:

- CO-only (ESR-A13P-CO): A single electrochemical cell that detects CO. Instruments with this sensor cannot detect H₂S.
- H₂-compensated CO (ESR-A1CP-CO-H): A single electrochemical cell that detects CO. This sensor does not respond to or responds minimally to hydrogen (displays H₂ RICH once H₂ concentration reaches 2000 ppm). Instruments with this sensor cannot detect H₂S.
- H₂S only (ESR-A13i-H₂S): A single electrochemical cell that detects H₂S. Instruments with this sensor cannot detect CO.
- CO/H₂S (ESR-A1DR-COHS): A combination electrochemical cell that detects both CO and H₂S.

Dummy Sensors

A dummy sensor is installed in any units that have less than 3 sensors. Dummy sensors are factory installed. The flat side of the dummy sensor faces away from the GX-Force and the hollow side faces toward the GX-Force.

Filters

Combustible Gas Sensor H₂S Removal Filter Disk (Dark Red)

An H₂S removal filter disk is placed into a recess in the filter gasket over the combustible gas sensor. The filter disk prolongs the life of the combustible gas sensor by preventing H₂S in the ambient air from reaching the sensor. The H₂S filter disk is dark red in color and although it may darken over time, its color is not indicative of remaining filter life.

The H₂S filter disk needs replacing once it's been exposed to 33 ppm hours of H₂S. This means the filter needs replacing after 80 minutes of exposure to 25 ppm H₂S which equates to 40, 2-minute calibrations with a cylinder containing 25 ppm H₂S. If H₂S exists in the monitoring environment, the H₂S filter disk will have to be replaced more frequently.

CO/H₂S Sensor Dual Filter (Black and White)

A dual filter is placed into a recess in the filter gasket over the dual CO/H₂S sensor. The black half is a charcoal filter for the CO sensor. The white half is a humidity filter for the H₂S sensor.

Replace the filter if you notice the following:

- Unexplained CO readings
- For users with a 1 ppm H₂S alarm setpoint, the filter should be replaced every 6 months, if you notice a drift on the H₂S zero reading, unexplained H₂S readings, or if the filter appears dirty (whichever is sooner).

CO-Only and H₂-Compensated CO Sensor Charcoal Filter (Black)

A black charcoal filter is placed into a recess in the filter gasket over the CO sensor. The charcoal filter disk scrubs H₂S and certain hydrocarbons out of the sample to avoid false CO readings. If false or elevated CO readings are noticed, especially in the presence of H₂S, change the charcoal filter.

H₂S Sensor Humidity Filter (White)

A white humidity filter covers the H₂S sensor. The filter absorbs humidity in the sampling environment to prevent unstable readings around 0 ppm H₂S. For users with a 1 ppm H₂S alarm setpoint, the filter should be replaced every 6 months, if you notice a drift on the zero reading, or if the filter appears dirty (whichever is sooner). For users with a 2 ppm or higher H₂S setpoint, the filter does not necessarily need to be replaced.

Inlet Filter Holder

The filter holder is a clear plastic dome-shaped piece on the top of the case. A male quick connect fitting is located on the inlet filter holder. This is the GX-Force's inlet fitting. The filter holder may be removed by turning it counterclockwise and pulling it away from the case. One flat membrane disk hydrophobic filter, a wire mesh disk, and a rubber filter retaining gasket are held in place by the filter holder and are located in the bottom of the case chamber where the filter holder is installed.

Exhaust

Sample gas flows from the sensors to the exhaust port on the back of the GX-Force.

USB Type-C Data/Charging Port and Protective Cover

A USB Type-C port is located on the bottom of the GX-Force, protected by a rubber cover. Pry off this cover when plugging in a USB Type-C cable (for charging or data transfer). A USB Type-C adapter cable can be connected to a computer's USB port to transfer data to the GX-Force Data Logger Management Program.

See the *GX-Force Data Logger Management Program Operator's Manual* for downloading instructions.

Battery Pack

A lithium ion (Li-ion) battery pack powers the GX-Force. At 25°C, the battery lasts at least 30 hours. The battery icon in the lower left corner of the LCD shows remaining battery life.

A low battery warning activates when the GX-Force detects a low battery voltage. The GX-Force sounds a dead battery alarm when battery voltage is too low for Measuring Mode.

The battery pack can be recharged using an AC or DC charger.

NOTE: Use of batteries or battery chargers not specified by RKI Instruments, Inc. will compromise the CSA classification and may void the warranty. See “Recharging the Lithium Ion Battery Pack” on page 99.

WARNING: *To prevent ignition of a hazardous atmosphere, batteries must only be charged in an area known to be nonhazardous.*

AVERTISSEMENT: *Pour éviter l'inflammation d'une atmosphère dangereuse, les batteries ne doivent être chargées que dans une zone connue pour être non dangereuse.*

Included Accessories

Included accessories consist of the tapered rubber nozzle, belt clip, and USB Type-A to Type-C data cable.

Tapered Rubber Nozzle

A cone-shaped 4-inch long rubber nozzle is included with the GX-Force as standard. It can be installed on the inlet fitting by pushing the larger end over it. The smaller end can be inserted through a hole in a wall or some other access to an enclosed area to sample the environment.

Belt Clip

The belt clip can be mounted to the back of the case using 3 Phillips head screws. The belt clip allows the GX-Force to be securely attached to clothing or a belt.

USB Type-A to USB Type-C Cable

The USB cable can be ordered for connecting the GX-Force to a computer when using the GX-Force Data Logger Management Program.

NOTE: The USB Type A to Type C cable should not be used to charge the instrument. Its intended function is to communicate with the GX-Force Data Logger Management Program.

Optional Accessories

Several other accessories are available for the GX-Force.

AC Adapter Cable

The charging cable is a 4 foot cable with an AC adapter on one end and a USB Type-C charging plug that connects to the GX-Force on the other end.

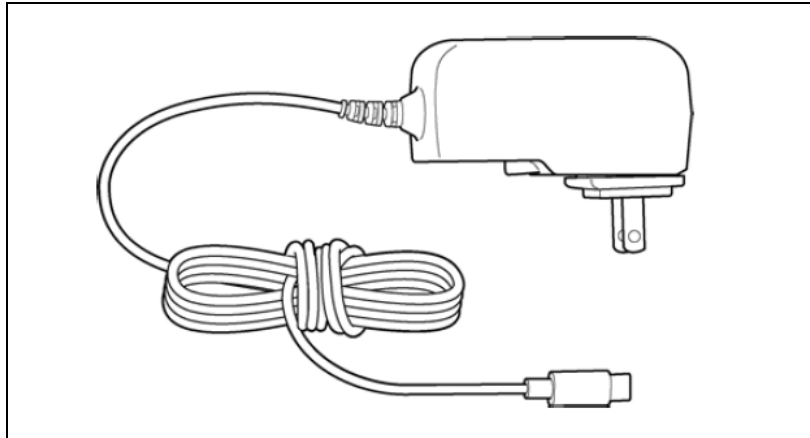

Figure 2: AC Adapter (USB Type-C)

Sample Hose & 8-Inch Probe

A sample hose and probe can be ordered with the GX-Force. When desired, the rubber nozzle may be removed and the sample hose and 8-inch probe may be connected to the inlet fitting. Sample hose lengths are available from 3 feet to 100 feet (see “Chapter 8: General Parts List” on page 108). The quick connect end of the sample hose connects to the inlet fitting of the GX-Force and the probe screws onto the end of the hose with the threaded fitting.

CAUTION: *Sample hose lengths of more than 100 feet are not recommended for the GX-Force because of flow rate reduction.*

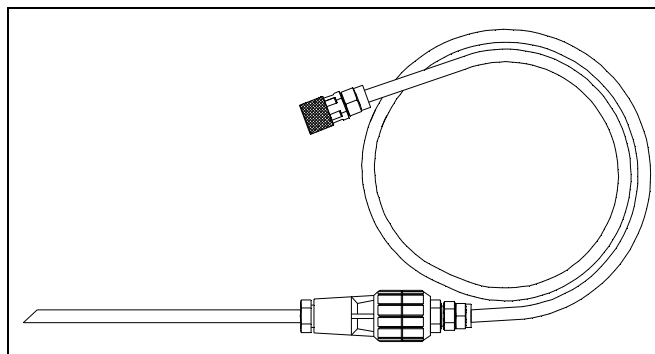

Figure 3: Sample Hose and Probe

External Dilution Fitting

A 1:1 external dilution fitting is available for the GX-Force. It is designed to mate with the inlet fitting and accept a sample hose and probe. The fitting is made with brass and nickel plated brass and is appropriate for use with the four standard gases. The fitting is normally used when it is necessary to introduce air into a sample that has no oxygen or a very low level of oxygen, such as a nitrogen-purged sample. It can also be used when one of the target gas levels in the sample area will likely be present in a concentration above the detection range for that gas. Since the fitting partially consists of unplated brass, it is not appropriate for detection of elevated levels of H₂S.

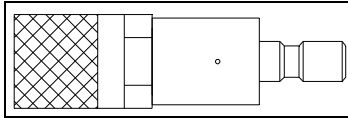

Figure 4: 1:1 Dilution Fitting

Chapter 3: Operation

Overview

This chapter explains how to use the GX-Force to perform confined space entry monitoring or general area monitoring in Measuring Mode.

Start Up

This section explains how to start up the GX-Force, get it ready for operation, and turn it off.

WARNING: *A thin protective film covers the display to prevent scratches during shipping. Remove this film before use. Leaving the film installed voids the intrinsically safe certification.*

Turning On the GX-Force

To illustrate certain functions, the following description of the GX-Force start up sequence assumes that the following menu items in User Mode are turned on: **LUNCH**, **CAL.RMDR**, and **BMP.RMDR** in User Mode, and **ID DISP** and **A.ZERO** in Maintenance Mode. If any of these items are turned off, then the corresponding screens will not appear.

1. Connect a tapered rubber nozzle or sample hose and probe to the GX-Force's quick-connect inlet fitting.
2. Press and briefly hold down POWER MODE. Confirm that the LCD turns on, the LEDs flash, the buzzer sounds, and the motor vibrates before continuing with operation. Release the POWER MODE button after the instrument beeps once.
3. If **LUNCH** is set to **ON** (factory setting if **OFF**, see page 90), the Lunch Break Screen appears. The unit counts down from 5 seconds.

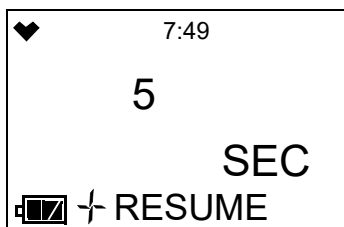

- a. Continue Accumulating: To continue accumulating peak and time-weighted average (TWA) readings from the last time the GX-Force was used, press POWER MODE or allow the countdown to reach 0. The short-term exposure limit (STEL) reading is reset each time the GX-Force is turned on.
- b. Reset Accumulation: To reset the accumulation of peak and time-weighted average (TWA) readings, press AIR before the countdown reaches 0.

4. If **CAL.RMDR** is set to **ON** (factory setting) and a calibration is due, the screen that appears next depends on the **CAL.EXPD** setting in User Mode (see page 82). The three possible screens are described below. If a calibration is not due, the instrument shows how many days are left until a calibration is due.

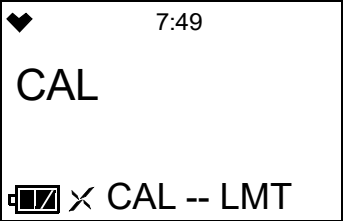
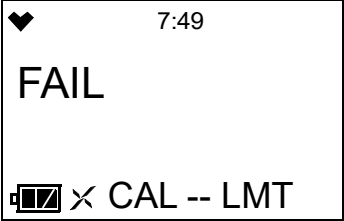
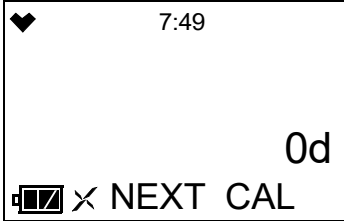
	CAL.EXPD set to CONFIRM (factory setting)	CAL.EXPD set to CANT USE	CAL.EXPD set to NONE
LCD			
Sound	Buzzer sounds double pulsing tone	Buzzer sounds double pulsing tone	None
Action	<ul style="list-style-type: none"> • <u>Option A, Perform calibration</u>: Press POWER MODE to perform a calibration. The instrument takes you straight to the AUTO.CAL CYL A screen in User Mode's GAS CAL/AUTO.CAL item. If PASS--W is set to ON, you must enter a password. See page 70 for calibration instructions. <p>If the calibration is successful, the screen above will not appear again until the unit is due for calibration. If the calibration is not successful, the screen above will again appear in the startup sequence.</p> <ul style="list-style-type: none"> • <u>Option B, Bypass message</u>: To continue without performing a calibration, press AIR. 	<ul style="list-style-type: none"> • The GX-Force cannot be used until a successful calibration is performed. Press POWER MODE to perform a calibration. The instrument takes you straight to the AUTO.CAL CYL A screen in User Mode's GAS CAL/AUTO.CAL item. If PASS--W is set to ON, you must enter a password. If you don't press POWER MODE, the instrument automatically goes to the AUTO.CAL CYL A screen after 6 seconds. See page 70 for calibration instructions. • If the calibration is successful, the screen above will not appear again until the unit is due for calibration. If the calibration is not successful, the screen above will again appear in the startup sequence. 	<ul style="list-style-type: none"> • <u>Option A, Perform calibration</u>: To perform a calibration, press POWER MODE. The instrument takes you straight to the AUTO.CAL CYL A screen in User Mode's GAS CAL/AUTO.CAL item. If PASS--W is set to ON, you must enter a password. • <u>Option B, Bypass message</u>: To continue without performing a calibration, wait a few seconds for the instrument to continue with its startup sequence.

5. If **BMP.RMDR** is set to **ON** (factory setting is **OFF**) and a bump test is due, the screen that appears next depends on how **BMP.EXPD** is set in User Mode (see “**BMP.EXPD**” on page 87). The three possible screens are described below. If a bump test is not due, the instrument shows how many days are left until a bump test is due.

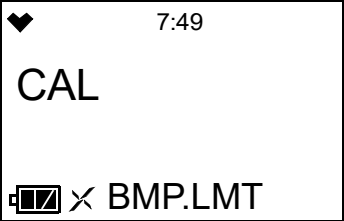
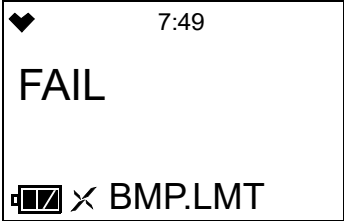
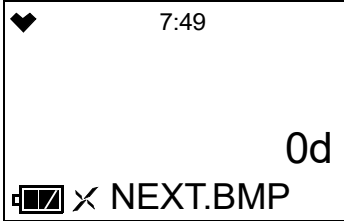
	BMP.EXPD set to CONFIRM (factory setting)	BMP.EXPD set to CANT USE	BMP.EXPD set to NONE
LCD			
Sound	Buzzer sounds double pulsing tone	Buzzer sounds double pulsing tone	None
Action	<ul style="list-style-type: none"> • <u>Option A, Perform bump test:</u> Press POWER MODE to perform a bump test. The instrument takes you straight to the BUMP CYL A screen in User Mode’s BUMP item. If PASS--W is set to ON, you must enter a password. See page 63 for bump test instructions. • If the bump test is successful, the screen above will not appear again until the unit is due for bump testing. If the bump test is not successful, the screen above will again appear in the startup sequence. • <u>Option B, Bypass message:</u> To continue without performing a bump test, press AIR. 	<ul style="list-style-type: none"> • The GX-Force cannot be used until a successful bump test has been performed. Press POWER MODE to perform a bump test. The instrument takes you straight to the BUMP CYL A screen in User Mode’s BUMP item. • If PASS--W is set to ON, you must enter a password. If you don’t press POWER MODE, the instrument automatically goes to the BUMP CYL A screen after 6 seconds. See page 63 for bump test instructions. • If the bump test is successful, the screen above will not appear again until the unit is due for bump testing. If the bump test is not successful, the screen above will again appear in the startup sequence. 	<ul style="list-style-type: none"> • <u>Option A, Perform bump test:</u> To perform a bump test, press POWER MODE. The instrument takes you straight to the BUMP CYL A screen in User Mode’s BUMP item. If PASS -- W is set to ON, you must enter a password. • <u>Option B, Bypass message:</u> To continue without performing a bump test, wait a few seconds for the instrument to continue with its startup sequence.

6. The Date/Time Screen appears for a few seconds.

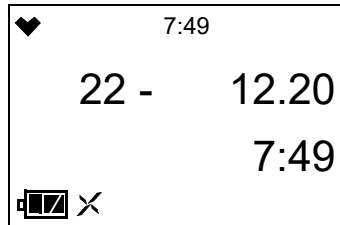

7. The Battery Voltage Screen appears for a few seconds.

An “AL-L” at the bottom of the screen indicates that the alarms are set to latching. An “AL-A” at the bottom of the screen indicates that the alarms are set to auto reset. See page 117 for changing the **LATCH** setting in Maintenance Mode.

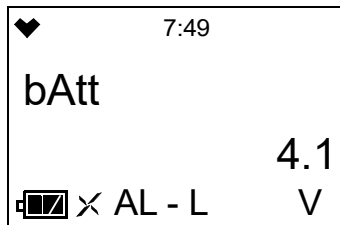

8. The combustible gas sensor contains 2 separate sensors: a standard catalytic sensor and a backup, poison-resistant sensor that is resistant to sensor poisons like silicone. An HC Gas List alarm indicates that the standard sensor has a reduced output, possibly due to one or more sensor poisons in the environment, and that the poison-resistant sensor is being used to provide gas readings. The poison-resistant sensor has a limited list of detectable gases. See Table 10 on page 48 for which gases can and cannot be detected during an HC Gas List condition.

The following screen appears, the LEDs flash, and the instrument beeps.

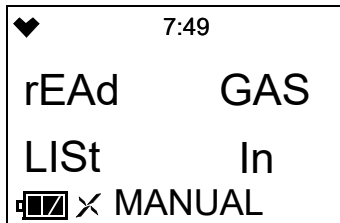

Press POWER MODE to confirm the HC Gas List screen and continue to the Gas Name Screen. If POWER MODE is not pressed after 5 seconds, the GX-Force will automatically proceed to the next screen.

NOTE: If your application requires detection of a gas still detectable after an HC Gas List condition (like methane or isobutane), there is no need to replace the combustible gas sensor.

However, if your application requires detection of a gas not detectable after an HC Gas List condition (like methanol or ethanol), you **must** replace the combustible gas sensor as soon as possible.

9. The following screens display for 3 seconds each: the Gas Name Screen, the Full Scale Screen, the Warning Setpoint Screen, the Alarm Setpoint Screen, the Alarm H Setpoint Screen, the STEL Alarm Screen, and TWA Alarm Screen.

NOTE: If the combustible gas is set to something other than CH₄ or H₂ in Gas Select Mode, the combustible channel is displayed as “HC” and the gas formula for the combustible gas sensor’s target gas appears during startup.

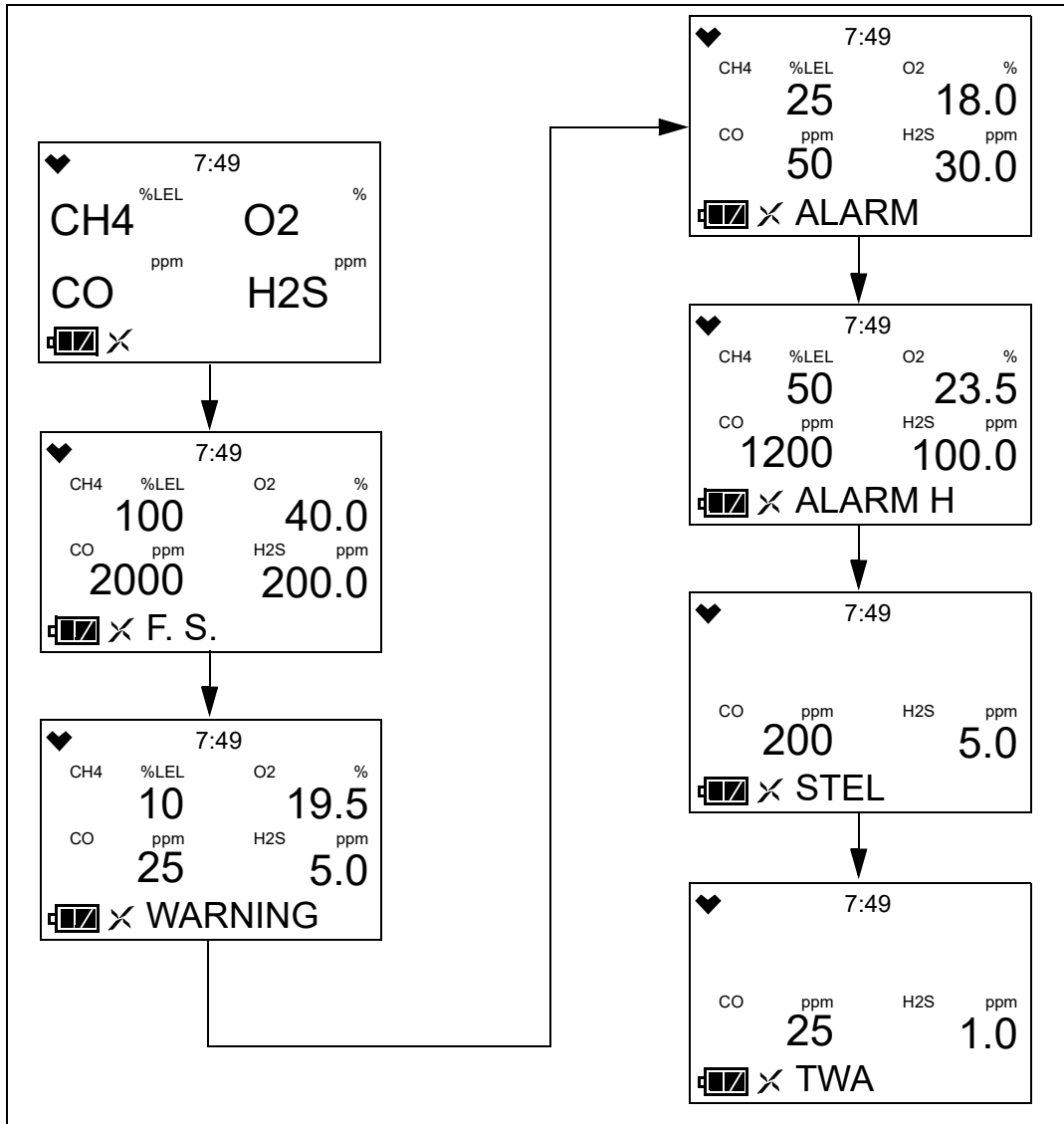

10. If **ID DISP** is set to **ON** (factory setting is **OFF**, see page 119), the User ID Screen appears for a few seconds, followed by the Station ID Screen.

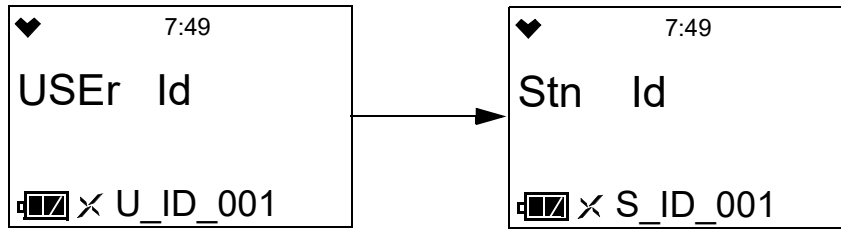

11. If the GX-Force experiences a sensor failure during start up, the display shows which sensor failed and the buzzer sounds a double pulsing tone once per second. In the example below, the combustible gas sensor failed.

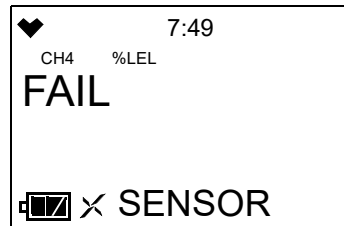

Press **POWER MODE** to acknowledge the failure and continue. “- - -” replaces the failed sensor’s gas reading. Replace the failed sensor as soon as possible.

12. If **A.ZERO** is set to **ON** (factory setting is **OFF**, see page 118), the instrument prompts you to do an auto zero. An auto zero operation sets the combustible gas, H₂S, and CO channels to zero and the O₂ channel to 20.9%.

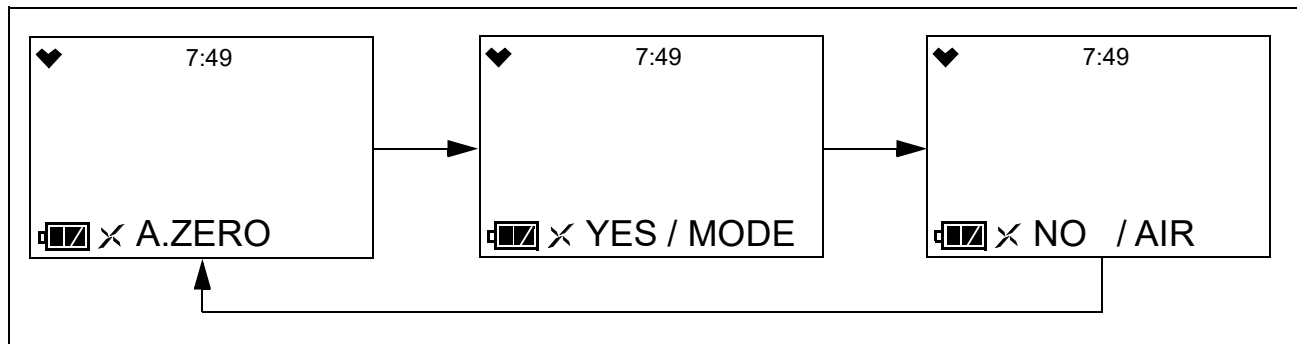

WARNING: *Make sure that the instrument is in a known fresh air environment (an environment free of combustible or toxic gases and of normal oxygen content, 20.9%) before performing an auto zero operation. If you perform an auto zero operation in an area with gases present, the adjustment will not be accurate.*

You must press **POWER MODE** to perform an auto zero function. If you do not press any key after 15 seconds, the instrument enters Measuring Mode without performing an auto zero.

If **PASS--W** is turned **ON** (factory setting is **OFF**), a user-set password is required to perform an auto zero. When the password screen appears, adjust each digit with the AIR button and press the POWER MODE button to move on to the next digit. Once the password is entered, the instrument performs the auto zero.

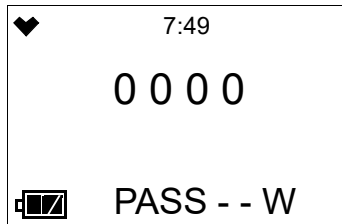

- At the end of the 45 second warmup, the GX-Force begins monitoring for gas in Measuring Mode. The Measuring Mode Screen displays the current gas reading for each target gas.

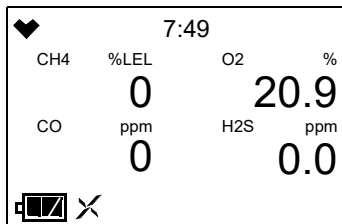

Performing a Demand Zero

Perform a demand zero before using the GX-Force. This sets the combustible gas, H₂S, and CO channels to zero and the O₂ channel to 20.9%.

- Find a fresh-air environment. This is an environment free of toxic or combustible gases and of normal oxygen content (20.9%).
- Turn on the unit as described above in “Turning On the GX-Force” on page 21.
- Press and hold AIR. The LCD prompts you to continue holding AIR and the buzzer pulses while you hold the button (if **KEY.TONE** is set to **ON** in User Mode).
- Continue to hold AIR until the LCD prompts you to release it. The GX-Force sets the fresh air reading for all channels. Start up is complete and the unit is now ready for monitoring.
- If **PASS--W** is turned **ON** (factory setting is **OFF**), a user-set password is required to perform a demand zero. When the password screen appears, adjust each digit with the AIR button and press the POWER MODE button to move on to the next digit. Once the password is entered, the instrument performs the demand zero.

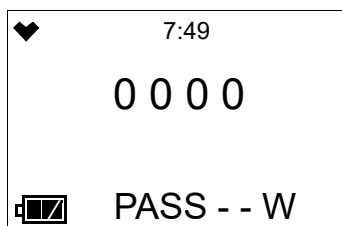

Turning Off the GX-Force

1. To turn off the GX-Force, wait for all readings to return to zero (20.9% for oxygen) and press and hold POWER MODE.

NOTE: If any channel is displaying a non-fresh air reading during shutdown, the instrument will perform a purge to clear the internal pump system. A 30-second countdown will be displayed.



2. “**TURN OFF**” appears on the display and the buzzer pulses three times (if **KEY.TONE** is set to **ON** in User Mode).
3. Release the button when “**TURN OFF**” disappears from the display.
4. If **PASS - - W** is turned **ON** (factory setting is **OFF**), a user-set password is required to turn off the GX-Force. When the password screen appears, adjust each digit with the AIR button and press the POWER MODE button to move on to the next digit. Once the password is entered, the instrument shuts off.

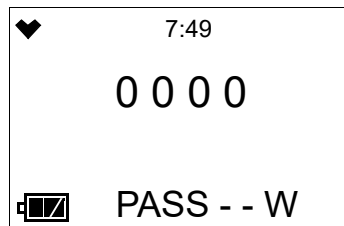

5. If you plan to leave the instrument off for an extended period of time, see page 107.

Measuring Mode Operation

When the GX-Force completes its startup sequence, it is in Measuring Mode. In Measuring Mode, the GX-Force continuously monitors the sampled atmosphere and displays the target gas concentrations. The GX-Force is considered to be in Normal Operation if there are no alarm indications.

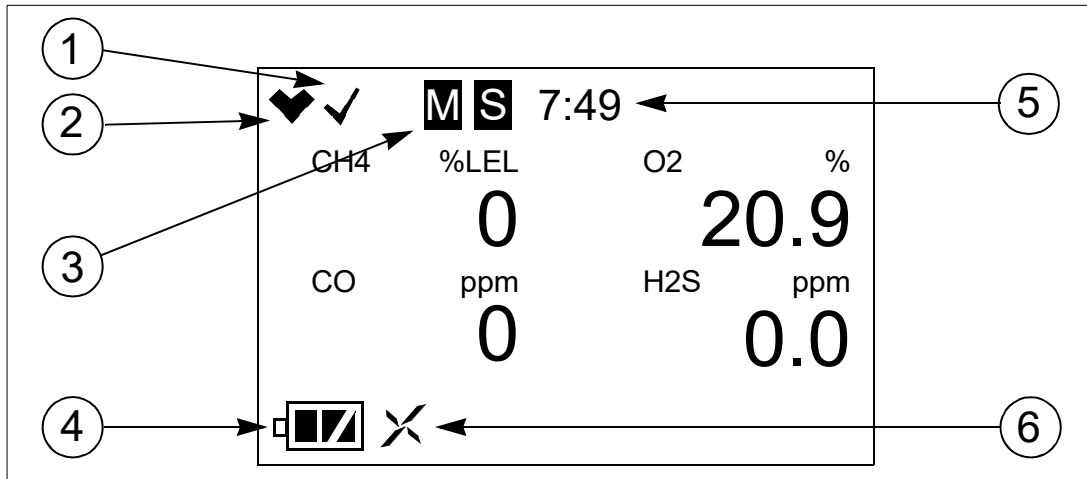





Figure 5: Measuring Mode Display

1. Check Mark: If **BMP.RMDR** is set to **ON** and a bump test is not due, a check mark appears in the upper left corner of the LCD.
2. Heart Symbol: The heart symbol in the upper left corner of the LCD indicates the operation status and blinks when normal. A microprocessor error causes the heart symbol to stop flashing or to disappear.
3. **M**: The instrument is operating in User Mode, Maintenance Mode, or Gas Select Mode.
S: The instrument is operating in Stealth Mode.
4. Battery Icon: Displays one of three levels of battery charge
 - : Fully charged
 - : Low charge
 - : Depleted, needs charging
5. Clock: The current time is displayed at the top of the LCD in 24-hour format.
6. Fan/Pump Icon: The X-shaped icon next to the battery indicates that the pump is active and will rotate in place when functioning properly.

Confirmation/Non-Compliance Indicator

If the **BEEP** menu item in User Mode is set to anything other than **OFF**, the GX-Force beeps periodically to confirm that it's operating or to indicate a non-compliance (see page 91).

Monitoring an Area

1. Start up the GX-Force as described above in “Start Up” on page 21. It is now in Measuring Mode.

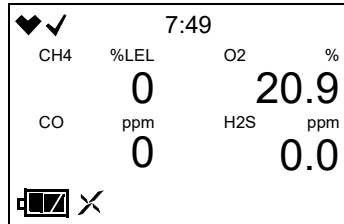

2. Take the GX-Force to the monitoring area.
3. Wait at least 15 seconds and monitor the display for gas readings. Allow readings to stabilize to determine the gas concentrations present.
4. If a gas alarm occurs, take appropriate action. See page 36.
5. Do not expose the GX-Force to rain.
6. The GX-Force’s IP 67 ratings do not imply that the GX-Force will detect gas during and after exposure to those conditions. If exposure occurs, dry the instrument with a cloth and perform a bump test as described on page 63.
7. If the GX-Force gets exposed to flammable liquids:
 - a. Wipe the instrument off with a cloth dampened with water.
 - b. Replace the filters as described on page 100 and page 102 if they become saturated.
 - c. Perform a bump test as described on page 63.
8. If you suspect that the GX-Force is not operating correctly:
 - a. Take the GX-Force to a fresh air environment and perform a demand zero as described on page 27.
 - b. Perform a bump test as described on page 63.

Combustible Gas Detection

There are three issues to keep in mind when monitoring for combustible gas.

Response

The combustible gas sensor responds to any combustible gas. The standard calibrated target gas for the combustible gas channel is methane (CH₄). If the instrument is setup for and calibrated to a different combustible gas, such as hexane or propane, the gas name right above the readings displays as “HC”.

- **Automatic Conversion**

The GX-Force can automatically display converted target gas readings if the instrument’s calibrated target gas is methane or isobutane. See “Combustible Sensor Target Gas Conversion (LIST)” on page 47.

- **Manual Conversion**

You can manually calculate a converted target gas reading using Table 4 if the instrument's calibrated target gas is methane. The table lists the conversion factors for several hydrocarbon gases **if the GX-Force is calibrated to methane.**

To use this table, multiply the display reading on the combustible gas channel by the factor in the appropriate row to obtain the actual gas concentration. For example, if you are detecting ethylene and the display reads 10% LEL for the combustible gas channel, you actually have $10\% \text{ LEL} \times 0.83 = 8.3\% \text{ LEL}$ ethylene present.

Table 4: LEL Hydrocarbon Conversion Factors

Gas	LEL Conversion Factor (from CH ₄ Cal.)
Acetone	2.22
Acetylene	1.43
Benzene	2.50
Butadiene	1.52
Cyclopentane	1.45
DME	1.16
Ethane	0.94
Ethanol	1.96
Ethyl Acetate	2.86
Ethylene	0.83
Heptane	3.13
Hexane	1.89
Hydrogen	0.95

Gas	LEL Conversion Factor (from CH ₄ Cal.)
IPA	1.64
Isobutane	1.10
MEK	2.63
Methane	1.00
Methanol	1.82
MIBK	4.00
MMA	3.33
Nonane	9.09
Propane	1.12
Propylene	0.97
THF	2.33
Toluene	4.55
Xylene	7.69

Overscale Protection

The GX-Force protects the combustible gas sensor by temporarily turning off the sensor power if levels exceeding 100% LEL are detected. Nevertheless, combustible gas concentrations above 100% LEL can still affect the zero level or calibration of the combustible gas sensor.

CAUTION: *Do not expose the combustible gas sensor to high concentrations of combustible gas such as that from a butane lighter. Exposure to high concentrations of combustible gas may adversely affect the performance of the sensor.*

CAUTION: *Any rapid increase in the combustible gas reading on the combustible gas channel followed by a declining or erratic reading may indicate a gas concentration above the LEL which may be hazardous.*

Damaging Gases

Some gases such as silicone vapors, chlorinated hydrocarbons, and sulphur compounds can contaminate the sensor's detection elements. This causes sensor damage and/or a reduced response to combustible gas. Make every effort to avoid these gases.

The H₂S scrubber disks protect the combustible sensor from H₂S, but you should avoid other sulphur compounds.

HC Gas List Alarm

An HC Gas List alarm can occur at startup or after a calibration.

The combustible gas sensor actually contains 2 separate sensors: a standard catalytic sensor and a backup sensor that is resistant to sensor poisons like silicone. An HC Gas List alarm indicates that the standard sensor has a reduced output, possibly due to one or more sensor poisons in the environment and that the poison-resistant sensor is being used to provide gas readings. The poison-resistant sensor has a limited list of detectable gases. The table shown on page 47 shows which gases can and cannot be detected after receiving an HC Gas List alarm.

If your application requires detection of a gas still detectable after an HC Gas List condition (like methane or isobutane), there is no need to replace the combustible gas sensor.

However, if your application requires detection of a gas not detectable after an HC Gas List condition (like methanol or ethanol), you **must** replace the combustible gas sensor as soon as possible.

Oxygen-Enriched Atmospheres

The GX-Force is not intended for use in oxygen-enriched atmospheres.

WARNING: *Do not use the GX-Force in an environment with an oxygen concentration above 21%.*

H₂-Compensated CO Detection

Instruments with an H₂-compensated CO sensor installed do not display H₂ readings, but if the H₂ concentration rises above 2000 ppm, the instrument will go into an "H₂ rich" alarm.

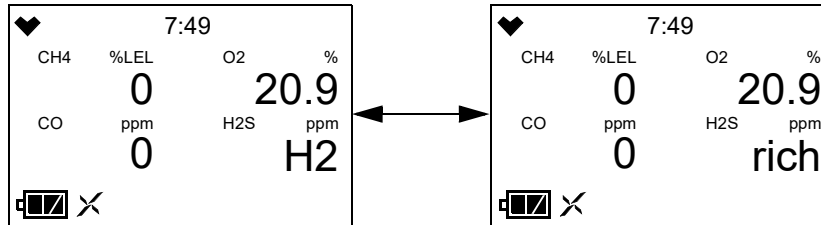

NOTE: The H₂-compensated CO sensor may not effectively compensate for higher levels of H₂ if exposed to temperatures above 40°C for longer than 15 minutes. Under these conditions, it can appear to the instrument that the H₂ concentration has exceeded 2000 ppm, the max concentration that can be compensated for, resulting in a CO reading higher than the actual CO level.

Interference Information

Some gases interfere with CO and H₂S sensors. For a complete list of these gases, see page 134.

Alarms

This section covers alarm indications in Measuring Mode. It also describes responding to and resetting an alarm condition.

NOTE: False alarms may be caused by radio frequency (RF) or electromagnetic (EMI) interference. Keep the GX-Force away from RF and EMI sources such as radio transmitters or large motors.

Alarm Indications

The GX-Force buzzer sounds an alarm, the LEDs flash, and the vibrator pulses when any sort of alarm condition or failure occurs. If the GX-Force is operating in Stealth Mode, the buzzer does not sound and the vibrator's operation depend on the **VIB** setting in Gas Select Mode's **STEALTH** menu item. See page 130 for more information.

NOTE: If an alarm condition occurs while you are in Display Mode, the GX-Force automatically returns to the Measuring Mode screen.

Table 5 summarizes the types of alarms produced by the GX-Force and their indications.

Table 5: Alarm Types and Indications

Alarm Type	Visual Indications	Other Indications
<p><u>Warning</u> Concentration of gas rises above the Warning setting or falls below the Warning setting for O₂.</p>	<ul style="list-style-type: none"> Affected channel's gas reading, gas name, and units flash WARNING appears at the bottom of the LCD Alarm LEDs flash in circle sequence once per second Backlight turns on 	<ul style="list-style-type: none"> High-low tone sounding once per second Vibrator pulses once per second
<p><u>Alarm</u> Concentration of gas rises above the Alarm setting or falls below the Alarm setting for O₂.</p>	<ul style="list-style-type: none"> Affected channel's gas reading, gas name, and units flash ALARM appears at the bottom of the LCD Alarm LEDs flash in circle sequence twice per second Backlight turns on 	<ul style="list-style-type: none"> High-low tone sounding twice per second Vibrator pulses twice per second
<p><u>Alarm H</u> Concentration of gas rises above the Alarm H setting.</p>	<ul style="list-style-type: none"> Affected channel's gas reading, gas name, and units flash ALARM H appears at the bottom of the LCD Alarm LEDs flash in circle sequence twice per second Backlight turns on 	<ul style="list-style-type: none"> High-low tone sounding twice per second Vibrator pulses twice per second
<p><u>TWA or STEL</u> Concentration of CO or H₂S rises above the TWA or STEL alarm setting.</p>	<ul style="list-style-type: none"> Affected channel's gas reading, gas name, and units flash TWA or STEL appears at the bottom of the LCD Alarm LEDs flash in circle sequence once per second Backlight turns on 	<ul style="list-style-type: none"> High-low tone sounding once per second Vibrator pulses once per second
<p><u>H₂ RICH (for instruments with H₂-compensated CO sensors)</u> Concentration of hydrogen rises above 2000 ppm (parts per million).</p>	<ul style="list-style-type: none"> H₂ and rich alternate in the lower right corner Alarm LEDs flash twice per second Backlight turns on 	<ul style="list-style-type: none"> High-low tone sounding twice per second Vibrator pulses twice per second

Table 5: Alarm Types and Indications

Alarm Type	Visual Indications	Other Indications
<u>Over Range</u>	<ul style="list-style-type: none"> Affected channel's gas reading is replaced with a flashing □□□ Gas name and units flash OVER appears at the bottom of the LCD Alarm LEDs flash in circle sequence twice per second Backlight turns on 	<ul style="list-style-type: none"> High-low tone sounding twice per second Vibrator pulses twice per second
<u>Minus Over Range</u>	<ul style="list-style-type: none"> Affected channel's gas reading is replaced with a flashing □□□ Gas name and units flash M OVER appears at the bottom of the LCD Alarm LEDs flash in circle sequence twice per second Backlight turns on 	<ul style="list-style-type: none"> High-low tone sounding twice per second Vibrator pulses twice per second
<u>Low Battery Warning</u>	<ul style="list-style-type: none"> The last bar in the battery icon starts flashing 	None
<u>Dead Battery Alarm</u>	<ul style="list-style-type: none"> Gas readings disappear. FAIL appears in the middle of the screen and BATTERY appears at the bottom of the screen. Alarm LEDs flash once per second 	Double pulsing tone once per second
<u>Sensor Failure</u>	<ul style="list-style-type: none"> SENSOR appears at the bottom of the screen and the failed sensor(s) are indicated with FAIL under the gas name. Alarm LEDs flash once per second 	Double pulsing tone once per second
<u>HC Gas List</u>	<ul style="list-style-type: none"> READ GAS LIST IN MANUAL appears on the screen. Alarm LEDs flash once per second 	Double pulsing tone once per second
<u>Clock Failure</u>	<ul style="list-style-type: none"> FAIL appears in the middle of the screen and CLOCK appears at the bottom of the screen. Alarm LEDs flash once per second 	Double pulsing tone once per second
<u>Flow Failure</u>	<ul style="list-style-type: none"> FAIL appears in the middle of the screen and FLOW appears at the bottom of the screen. Alarm LEDs flash once per second 	Double pulsing tone once per second

Table 5: Alarm Types and Indications

Alarm Type	Visual Indications	Other Indications
<u>Pump Failure</u>	<ul style="list-style-type: none"> • FAIL appears in the middle of the screen and PUMP appears at the bottom of the screen. • Alarm LEDs flash once per second 	Double pulsing tone once per second
<u>System Failure</u>	<ul style="list-style-type: none"> • FAIL SYSTEM appears at the bottom of the screen and an error code displays in the middle • Alarm LEDs flash once per second 	Double pulsing tone once per second

Responding to Alarms

This section describes response to gas, over range, battery, sensor failure, HC Gas List, clock failure, flow/pump failure alarms, and system failure alarms.

Responding to Gas Alarms

1. Determine which gas alarm has been activated.
2. Follow your established procedure for an increasing gas condition or a decreasing oxygen condition.

Reset or silence the alarm as necessary or allowed. Alarm silence can be turned on or off using the **ALM.SLNC** menu item in Maintenance Mode (see page 117) or the GX-Force Data Logger Management Program (see the *GX-Force Data Logger Management Program Operator's Manual*). Table 6 summarizes resetting and silencing alarms for all **LATCH** and **SILENCE** combinations that are possible.

Table 6: Resetting and Silencing Alarms

	LATCH: ON (factory setting)	LATCH: OFF
BUZZER SILENCE: ON	<ul style="list-style-type: none"> • Press the POWER MODE or AIR buttons to silence the buzzer. • If the gas concentration was still above the alarm level when the button was pressed, the LED arrays continue to flash, the vibrator continues to pulse, and the GX-Force continues to display the current alarm level. • The gas reading must fall below (or rise above for an oxygen low alarm) an alarm setting before you can reset the alarm, the LEDs, and the vibrator using the POWER MODE or AIR buttons. <p><i>NOTE: If PASS--W is ON (factory setting: OFF), press POWER MODE <u>and</u> AIR simultaneously and then enter the user-set password to reset an alarm condition.</i></p>	<ul style="list-style-type: none"> • Press the POWER MODE or AIR buttons to silence the buzzer. • The POWER MODE or AIR buttons will not reset the alarm. • The alarm, LEDs, and vibrator will automatically reset when gas reading falls below (or rises above for an oxygen low alarm) an alarm setpoint.
<u>ALARM SILENCE: OFF</u> <i>(factory setting)</i>	<ul style="list-style-type: none"> • Pressing POWER MODE or AIR will not silence buzzer. • The gas reading must fall below (or rise above for an oxygen low alarm) an alarm setting before you can reset the alarm condition using the POWER MODE or AIR buttons. 	<ul style="list-style-type: none"> • Pressing POWER MODE or AIR will not silence buzzer. • The alarm condition will automatically reset when the gas reading falls below (or rises above for an oxygen low alarm) an alarm setpoint.

Responding to an H2 RICH Alarm (H₂-Compensated CO Sensor Only)

The H2 RICH alarm automatically clears once the hydrogen level decreases below 2000 ppm (parts per million).

Responding to Over Range Alarms

WARNING: *An over range condition may indicate an extreme combustible gas, toxic gas, or oxygen concentration. Confirm the gas concentration with a different GX-Force or with another gas detecting device.*

CAUTION: *High off-scale readings may indicate an explosive concentration.*

PRUDENCE: *Des lectures élevées hors échelle peuvent indiquer une concentration explosive.*

1. Determine which channel is in alarm.

2. Follow your established procedure for an extreme gas condition.
3. If **LATCH** is set to **ON** (factory setting) in Maintenance Mode, reset the alarm using **POWER MODE** or **AIR** once the alarm condition clears.

If **PASS - - W** is turned **ON** (factory setting is **OFF**), you must press **POWER MODE** and **AIR** at the same time and then enter a user-set password to reset an alarm condition. When the password screen appears, adjust each digit with the **AIR** button and press the **POWER MODE** button to move on to the next digit. Once the password is entered, the alarm condition resets.

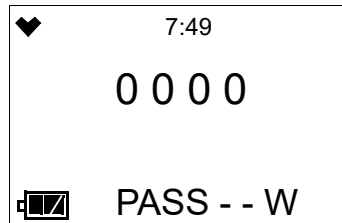

4. Calibrate the GX-Force as described on page 58.
5. If the over range condition continues or if you are not able to successfully calibrate the unit, you may need to replace the sensor that has triggered the over range alarm.
6. If the over range condition continues after you have replaced the sensor, contact RKI Instruments, Inc. for further instructions.

Responding to Battery Alarms

WARNING: *The GX-Force is not operational as a gas monitoring device during a dead battery alarm. Take the Model GX-Force to a non-hazardous area and recharge the batteries as described in “Recharging the Lithium Ion Battery Pack” on page 99.*

The GX-Force is fully functional during a low battery warning. However, only 1-2 hours of operating time remain. The amount of operating time left depends on LCD backlight use and the alarm frequency. Recharge the battery as soon as possible as described in “Recharging the Lithium Ion Battery Pack” on page 99.

NOTE: Alarms and the LCD back light consume battery power and reduce the amount of operating time remaining.

Responding to Sensor Failure Alarms

1. Determine which sensor triggered the sensor failure alarm.
2. Calibrate the failed sensor, as described on page 58.
3. If the sensor failure continues or if the sensor could not be calibrated, replace the sensor as described on page 105.
4. If the sensor failure condition continues after you have replaced the sensor, contact RKI Instruments, Inc. for further instructions.

Responding to an HC Gas List Alarm

An HC Gas List alarm can occur at startup or after a calibration.

1. Press POWER MODE to acknowledge the alarm.

The combustible gas sensor actually contains 2 separate sensors: a standard catalytic sensor and a backup, poison-resistant sensor that is resistant to sensor poisons like silicone. An HC Gas List alarm indicates that the standard sensor has a reduced output, possibly due to one or more sensor poisons in the environment, and that the poison-resistant sensor is being used to provide gas readings. The poison-resistant sensor has a limited list of detectable gases. Table 10 on page 48 shows which gases can and cannot be detected after receiving an HC Gas List alarm.

If your application requires detection of a gas still detectable after an HC Gas List condition (like methane or isobutane), there is no need to replace the combustible gas sensor.

However, if your application requires detection of a gas not detectable after an HC Gas List condition (like methanol or ethanol), you **must** replace the combustible gas sensor as soon as possible.

Responding to Clock Failure Alarms

A clock failure alarm occurs if the unit's internal clock malfunctions. A clock failure alarm might also occur if the battery becomes too drained during storage. See page 107 for storage information.

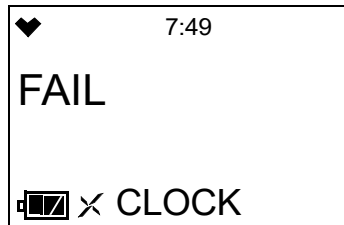

1. Press POWER MODE to proceed to Measuring Mode.

CAUTION: *If you operate the instrument after a clock failure, data will still be logged but the date/time will be incorrect. Set the date/time as described on page 95 as soon as possible to ensure logged data uses the correct date/time.*

2. Attempt to set the date using the **DATE** menu item in User Mode. See page 95.
3. If the date cannot be set correctly, contact RKI Instruments, Inc. as soon as possible.

Responding to a Flow Failure Alarm

Flow failure alarms can be caused by clogged dust filters or blockages in the instrument's internal flow paths.

1. If a flow failure occurs, the flow failure alarm screen displays.

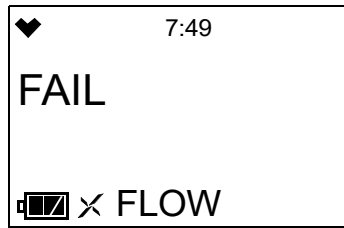

2. Inspect the internal pump's dust filter and the probe's dust filter and replace them if either is clogged or saturated by liquid (see page 102 and page 104).
3. If the low flow alarm persists after filter replacement, contact RKI Instruments, Inc. to schedule a repair.

Responding to a Pump Failure Alarm

Pump failure alarms can be caused by the instrument's internal pump.

NOTE: The pump's motor grease may solidify if not used for long periods of time. For long-term storage, the instrument should be turned on every 6 months to let the pump run. See "Chapter 7: Storage and Disposal" on page 107.

1. If a pump failure occurs, the pump failure alarm screen displays.

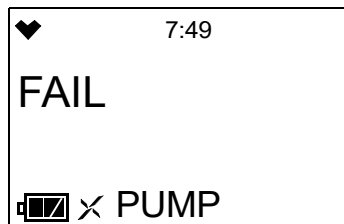

2. The pump failure alarm indicates that the pump must be replaced. Contact RKI Instruments, Inc. to schedule replacement.

Responding to System Failure Alarms

1. If a system failure occurs, the system failure screen displays an error code as shown below:

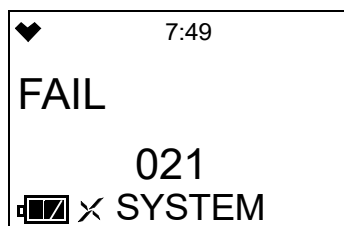

2. The error code meanings are shown in Table 7:

Table 7: Error Code Explanation

Error Code	Explanation
000	ROM failure
010	RAM failure
021	FRAM failure
031	FLASH memory failure
080	Circuit voltage anomaly
081	PCB failure
082	Temperature sensor failure

3. If the error code is anything but 031 as shown above, the instrument cannot be used. Contact RKI Instruments, Inc. as soon as possible.

If the error code is 031, you may press POWER MODE to continue into Measuring Mode if the instrument must be used temporarily.

CAUTION: *There will be no data logging function if you operate the instrument after a 031 system failure. Contact RKI Instruments, Inc. as soon as possible.*

Saving Snap Log Data

The GX-Force is capable of logging all channel readings at a given moment and can store up to 256 logs at one time. When the maximum number of logs has been reached, any new logs will overwrite the oldest data logged on the instrument.

All saved snap log data can be reviewed using the **REC.DATA** screen in Display Mode. Refer to “Viewing Snap Log Data (REC.DATA)” on page 55 for more information.

1. While in Measuring Mode, press and hold AIR and POWER MODE for several seconds. The snap log number, station ID, date and time, and value are displayed in the following sequence:

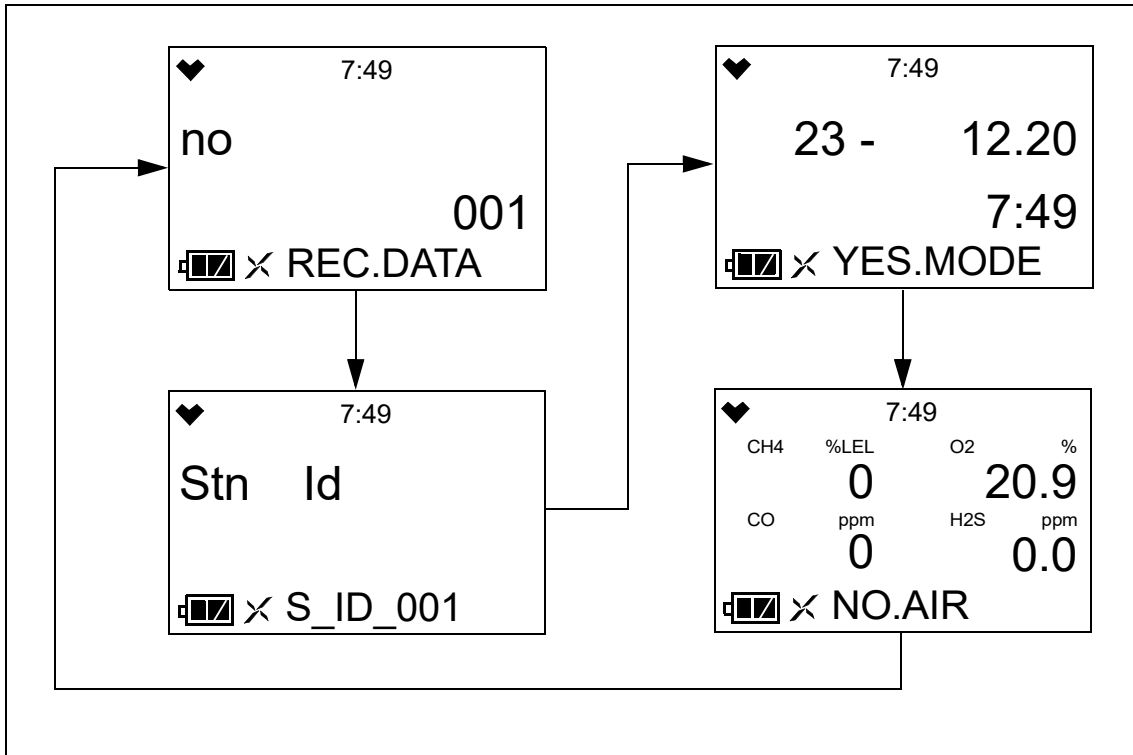

2. Press POWER MODE to save the captured snap log. The instrument confirms the log was saved before displaying the next log screen.

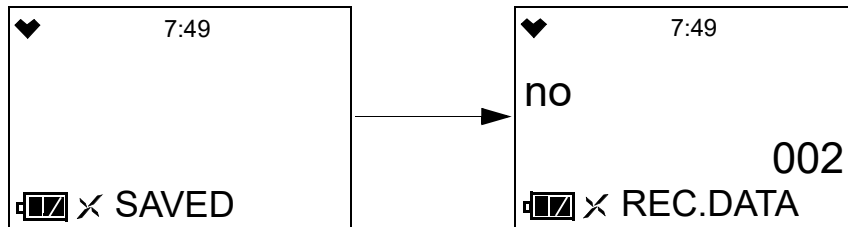

3. To return to the normal Measuring Mode, press AIR.
To save another snap log, press POWER MODE.

Data Logging

The GX-Force logs Measuring Mode gas readings, alarm data, calibration data, and saved snap logs to its internal memory. Logged data can be downloaded to a computer via the infrared communications port on the front of the unit.

To utilize the GX-Force's downloading capability, you will need the GX-Force Data Logger Management Program, a USB Type-C to USB Type-A data cable, and a computer with a USB port that runs one of the following operating systems: Windows 8, Windows 10, or Windows 11. The GX-Force Data Logger Management Program is available at www.rkiinstruments.com/gx-force.

The data logging capacity depends on how often the GX-Force stores data, how many channels are active, and how often the GX-Force is turned on and off. Table 8 illustrates how much data logging time is available for the various interval times. It assumes that the unit has three sensors, is only turned on once, and there are no alarm occurrences. The data logging interval time must be set using the GX-Force Data Logger Management Program.

Table 8: Data Logging Capacity

Interval Time	Data Logging Time
10 seconds	10 hours
20 seconds	20 hours
30 seconds	30 hours
1 minute	60 hours
3 minutes	180 hours
5 minutes (factory setting)	300 hours
10 minutes	600 hours

For a complete description of the Data Logger Management Program and procedures for downloading data to a computer, see the *GX-Force Data Logger Management Program Operator's Manual*.

Chapter 4: Display Mode

This section describes Display Mode which is accessible from Measuring Mode. See Table 9 for a list of Display Mode's menu items, a short description of each item, and the page number for further description.

Table 9: Display Mode Menu Items

Display Mode Menu Item	Description
LIGHT (page 46)	Turns the LED flashlight on and off
PEAK (page 46)	Displays each sensor's Peak reading
STEL (page 47)	Displays the STEL readings (CO and H ₂ S only)
TWA (page 47)	Displays the TWA readings (CO and H ₂ S only)
LIST (page 47)	<p>Changes the target gas for the catalytic sensor</p> <p><i>NOTE: Only appears if DISP.SET is set to ON in User Mode (factory setting) and if CH₄ or i-C₄H₁₀ is selected for the combustible gas in Gas Select Mode.</i></p> <ul style="list-style-type: none"> • CH₄ (methane) • i-C₄H₁₀ (isobutane) • H₂ (hydrogen) • CH₃OH (methanol) • C₂H₂ (acetylene) • C₂H₄ (ethylene) • C₂H₆ (ethane) • C₂H₅OH (ethanol) • C₃H₆ (propylene) • C₃H₆O (acetone) • C₃H₈ (propane) • C₄H₆ (butyne) • C₅H₁₀ (cyclopentane) • C₆H₆ (benzene) • n-C₆H₁₄ (hexane) • C₇H₈ (toluene) • n-C₇H₁₆ (heptane) • C₈H₁₀ (xylene) • n-C₉H₂₀ (nonane) • EtAc (ethyl acetate) • IPA (isopropyl alcohol) • MEK (methyl ethyl ketone) • MMA (methyl methacrylate) • DME (dimethyl ether) • MIBK (methyl isobutyl ketone) • THF (tetrahydrofuran) • n-C₅H₁₂ (n-pentane)
PUMP.OFF (page 50)	<p>Turns the internal pump off to conserve battery</p> <p><i>NOTE: Only appears if DISP.SET is set to ON in User Mode (factory setting) <u>and</u> if POFF.DISP is set to ON in Maintenance Mode (factory setting is OFF).</i></p>
USER ID (page 51)	<p>Displays and updates the instrument's User ID</p> <p><i>NOTE: Only appears if DISP.SET is set to ON in User Mode (factory setting) <u>and</u> if ID DISP is set to ON in Maintenance Mode (factory setting is OFF).</i></p>

Table 9: Display Mode Menu Items

Display Mode Menu Item	Description
STN ID (page 52)	Displays and updates the instrument's Station ID <i>NOTE: Only appears if DISP.SET is set to ON in User Mode (factory setting) <u>and</u> if ID DISP is set to ON in Maintenance Mode (factory setting is OFF).</i>
CAL.DATA (page 53)	Displays each sensor's last calibration date <i>NOTE: Only appears if CAL.RMDR is set to ON in User Mode (factory setting).</i>
BMP.DATA (page 54)	Displays each sensor's last bump test date <i>NOTE: Only appears if BMP.RMDR is set to ON in User Mode (factory setting is OFF).</i>
REC.DATA (page 55)	Displays all saved snap log data
TEMP (page 55)	Displays the current date, time, and temperature
ALARM--P (page 56)	Displays alarm setpoints

Tips for Using Display Mode

- To enter Display Mode and scroll from one menu item to the next or skip an item when a question is asked, press POWER MODE.
- To enter an item, press AIR.
- To change a flashing parameter, press AIR.
- To reverse the direction of movement in a list (ie. from down to up or vice versa):
 - a. Press and hold AIR.
 - b. Immediately press POWER MODE and then release both buttons.
- To exit from an entered-information screen and go back to the main menu, press POWER MODE.
- To exit Display Mode and return to Measuring Mode, press and hold both AIR and POWER MODE together.

NOTE: With the exception of the **PUMP.OFF** screen, each screen displays for 20 seconds. If no button is pressed within 20 seconds, the GX-Force automatically returns to Measuring Mode. If the pump is turned off using the **PUMP.OFF** setting, the **PUMP.OFF** screen will display until the pump is turned back on.

LED Flashlight (LIGHT)

The **LIGHT** menu item can be used to turn the GX-Force's LED flashlight on and off.

1. While in Measuring Mode, press POWER MODE once. The **LIGHT** menu item appears.

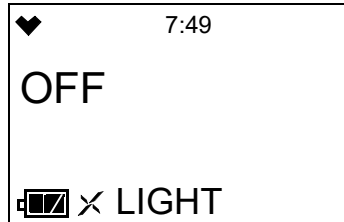

2. Press AIR to change the current setting.
3. Press POWER MODE to save the desired setting and move to the next menu item.

Peak Screen (PEAK)

The peak screen displays the highest (lowest for oxygen) concentrations detected since the GX-Force was turned on. Peak readings are stored in the GX-Force's memory until a higher level is detected (lower for oxygen), the peak reading is cleared, or the GX-Force is turned off.

The lunch break feature enables the GX-Force to save peak readings when it is turned off so it can continue with the same peaks when it is turned on again. See page 90 for instructions to turn the lunch break feature on (default is **OFF**).

To clear the peak readings, do the following:

NOTE: If **PASS - - W** is set to **ON**, the peak reading cannot be cleared.

1. While in Measuring Mode, press POWER MODE until **PEAK** appears.

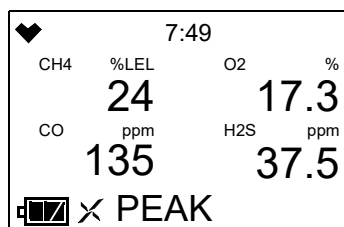

2. Press and hold AIR until the screen prompts you to release it.

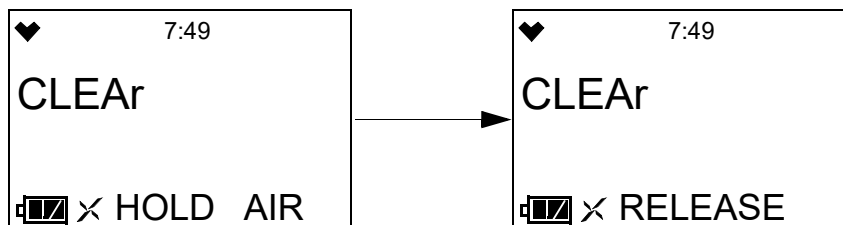

- The peak readings are cleared and the unit returns to the Peak Screen.
If you do not want to clear the peak readings, release AIR before the above screen sequence occurs. The unit returns to the Peak Screen.

STEL Screen (STEL)

The STEL Screen displays the short term exposure limit (STEL) readings *for H₂S and CO only*. The STEL reading is the average reading *over the last 15 minutes*.

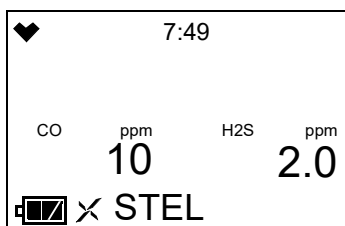

TWA Screen (TWA)

The TWA Screen displays the time weighted average (TWA) readings *for H₂S and CO only*.

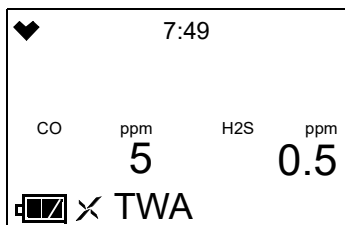

The TWA reading is the average reading *over the last 8 hours*. If 8 hours have not elapsed since the last time the TWA reading was cleared, the average is still calculated over 8 hours. The missing readings are assigned a 0 value. If **LUNCH** is set to **OFF** (factory setting), the TWA is cleared when the GX-Force is turned off.

If **LUNCH** is set to **ON**, the GX-Force remembers TWA readings when it is turned off so it can continue them when it is turned on again. See page 90 for instructions to turn the lunch break feature on (default is **OFF**).

Combustible Sensor Target Gas Conversion (LIST)

NOTE: This screen only appears if **DISP.SET** in User Mode is set to **ON** (factory setting) and if the instrument's calibrated target gas is CH₄ or iC₄H₁₀ (select target gas in Gas Select Mode's **GAS.COMB** item, calibrate with target gas in User Mode's **GAS CAL** item).

The **LIST** screen allows you to select a converted target gas based on a CH₄ or iC₄H₁₀ calibration. It does not change the calibrated target gas. You must go to Gas Select Mode's **GAS.COMB** item to change the calibrated target gas.

Selecting a converted target gas from the **LIST** screen (based on a CH₄ or iC₄H₁₀ calibration) does not provide the same reading accuracy as selecting a calibrated target gas in Gas Select Mode's **GAS.COMB** item and calibrating with that target gas in User Mode.

Selecting a converted target gas in **LIST** does not mean that the combustible gas sensor will respond only to that gas. The combustible gas sensor responds to a number of gases regardless of the target gas selection.

NOTE: If H₂ is selected as the target gas in **LIST**, the sensor will only respond to H₂ and will not respond to any other gas, regardless of the gas listings in Table 10.

If you select a new converted target gas, the change is saved after you turn the instrument off and on.

Table 10: Available HC Gas Conversions

Gas	Available Converted Gases Based on Calibrated Target Gas (Selected in Gas Select Mode)		Available Converted Target Gases During HC Gas List Condition
	CH ₄ (methane)	i-C ₄ H ₁₀ (isobutane)	
CH ₄ (methane)	-	x	O
i-C ₄ H ₁₀ (isobutane)	O	-	O
H ₂ (hydrogen)	O	O	O
CH ₃ OH (methanol)	O	O	x
C ₂ H ₂ (acetylene)	O	O	O
C ₂ H ₄ (ethylene)	O	O	O
C ₂ H ₆ (ethane)	O	x	O
C ₂ H ₅ OH (ethanol)	O	O	x
C ₃ H ₆ (propylene)	O	O	O
C ₃ H ₆ O (acetone)	O	O	x
C ₃ H ₈ (propane)	O	x	O
C ₄ H ₆ (butyne)	O	O	O
C ₅ H ₁₀ (cyclopentane)	O	O	O
C ₆ H ₆ (benzene)	O	O	x
n-C ₆ H ₁₄ (hexane)	O	O	O
C ₇ H ₈ (toluene)	O	O	x

Table 10: Available HC Gas Conversions

Gas	Available Converted Gases Based on Calibrated Target Gas (Selected in Gas Select Mode)		Available Converted Target Gases During HC Gas List Condition
	CH4 (methane)	i-C4H10 (isobutane)	
n-C7H16 (heptane)	O	O	O
C8H10 (xylene)	O	O	x
n-C9H20 (nonane)	O	O	x
EtAc (ethyl acetate)	O	O	x
IPA (isopropyl alcohol)	O	O	x
MEK (methyl ethyl ketone)	O	O	x
MMA (methyl methacrylate)	O	O	x
DME (dimethyl ether)	O	O	x
MIBK (methyl isobutyl ketone)	O	O	x
THF (tetrahydrofuran)	O	O	x
n-C5H12 (n-pentane)	O	O	O
x = not available O = available			

1. While in Measuring Mode, press POWER MODE until **LIST** appears.

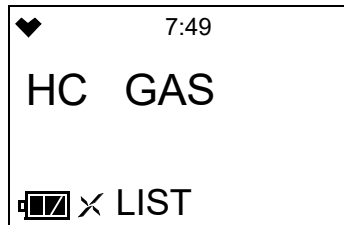

2. Press AIR to enter the screen. The current gas flashes at the bottom of the screen.

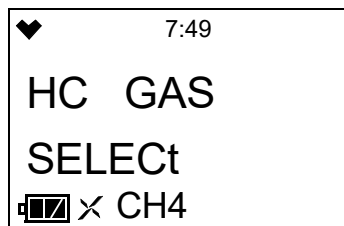

3. Use AIR to scroll through the list of gases.

- When the desired gas is displayed, press POWER MODE. The changes are saved and the instrument returns to the **LIST** screen.
- The gas formula displays at the bottom of the Measuring Mode screen. The gas selection remains selected if you turn the instrument off and on again.

Turning the Pump Off (PUMP.OFF)

WARNING: *The GX-Force is not a gas monitoring device while the pump is off.*

The **PUMP.OFF** screen only appears if **DISP.SET** in User Mode is set to **ON** (factory setting) and if **P.OFF DISP** in Maintenance Mode is set to **ON** (factory setting is **OFF**).

This menu item turns the internal pump off to prevent draining the battery while the instrument is not in active use. This can be useful if the instrument is being used intermittently throughout a monitoring session.

- While in Measuring Mode, press POWER MODE until the **PUMP.OFF** screen sequence appears.

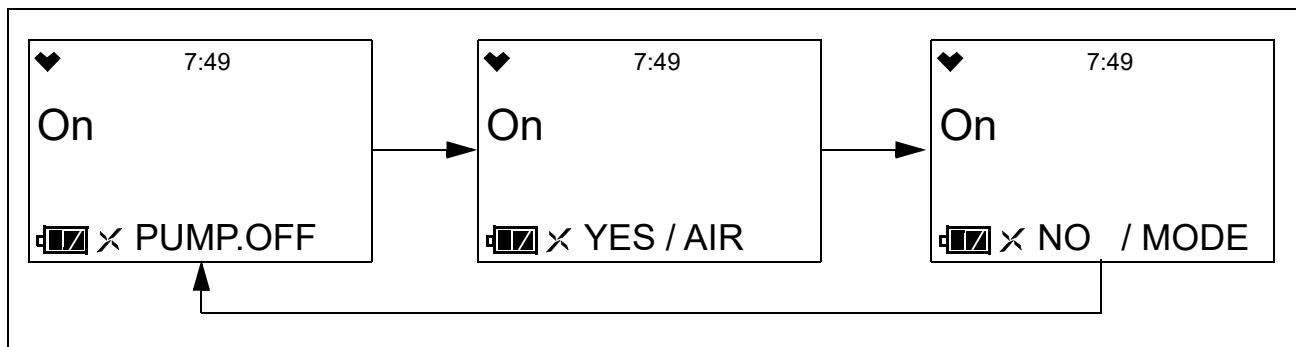

- To turn the internal pump off, press AIR. The pump will shut off and the pump fan icon next to the battery icon will disappear.

The **M** icon indicates that the instrument can only exit this screen when the pump is turned back on.

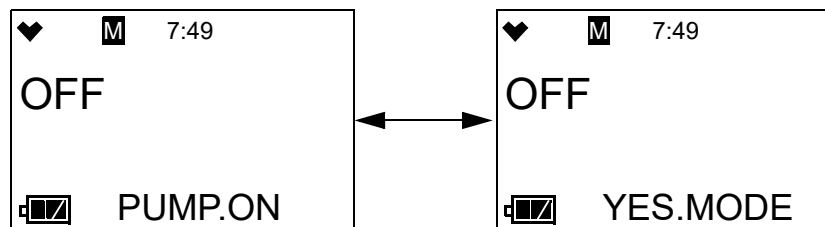

- Press POWER MODE to turn the internal pump back on and return to the **PUMP.OFF** menu item in Display Mode.

Changing the User ID (USER ID)

The **USER ID** screen only appears if **DISP.SET** in User Mode is set to **ON** (factory setting) and if **ID DISP** in Maintenance Mode is set to **ON** (factory setting is **OFF**).

Use this screen to select a user ID from the 128 user IDs that are stored in the GX-Force's memory. Before a user ID is selected on a brand new instrument, the user ID is "-----". The factory-installed user IDs have a "**U_ID_XXX**" format.

The user ID provides a way to identify the GX-Force user during a data logging session.

User IDs can only be selected in this menu item. In order to edit the 128 user IDs, you must use the GX-Force Datalogging Program.

1. While in Measuring Mode, press POWER MODE until the **USER ID** screen sequence appears.

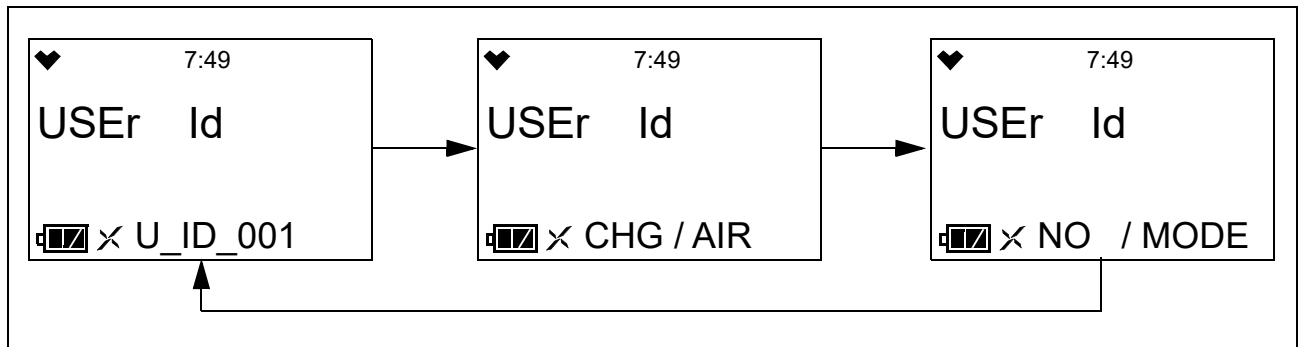

2. To change the User ID, press AIR. The current User ID flashes.

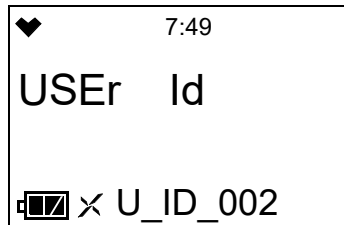

3. Use AIR to scroll to the desired User ID.
4. Press POWER MODE to save the User ID and return to the **USER ID** screen in Display Mode.

Changing the Station ID (STN ID)

The **STN ID** screen appears if **DISP.SET** in User Mode is set to **ON** (factory setting) and if **ID DISP** in Maintenance Mode is set to **ON** (factory setting is **OFF**).

Use this screen to select a station ID from the 128 station IDs that are stored in the GX-Force's memory. Before a station ID is selected on a brand new instrument, the station ID is "-----". The factory-installed station IDs have a "**S_ID_XXX**" format.

The station ID provides a way to identify the GX-Force location during a data logging session.

Station IDs can only be selected in this menu item. In order to edit the 128 station IDs, you must use the GX-Force Data Logger Program.

1. While in Measuring Mode, press POWER MODE until the **STN ID** screen sequence appears.

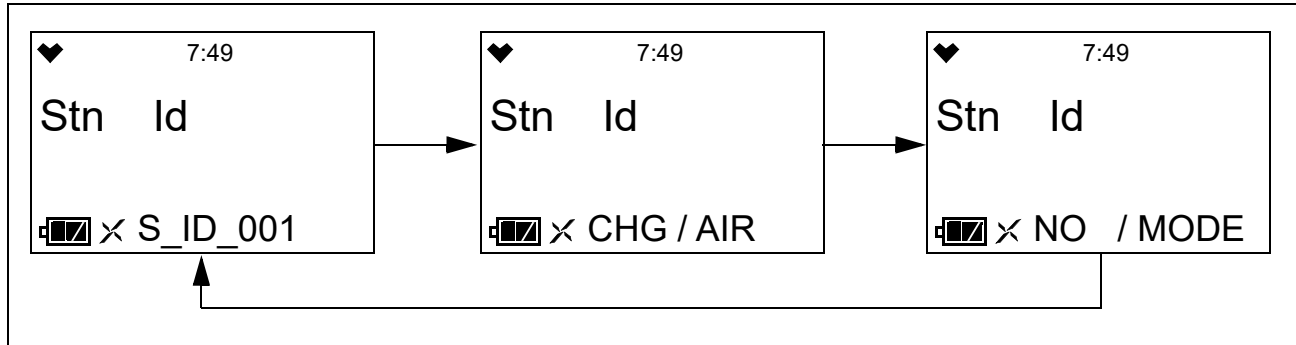

2. To change the station ID, press AIR. The current Station ID flashes.

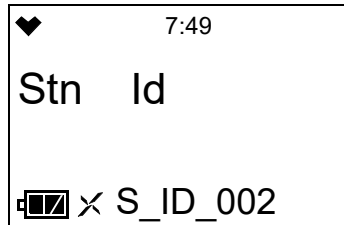

3. Use AIR to scroll to the desired station ID.
4. Press POWER MODE to save the station ID and return to the **STN ID** screen in Display Mode.

Last Successful Calibration Date (CAL DATA)

The **CAL DATA** screen shows the date of each installed sensor's last successful calibration. This screen only appears if **CAL.RMDR** is set to **ON** in User Mode.

1. While in Measuring Mode, press **POWER MODE** until **CAL DATA** appears.

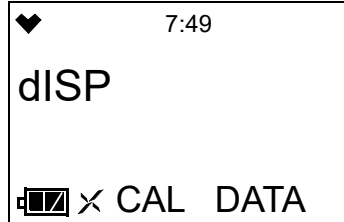

2. Press **AIR** to enter the **CAL DATA** screen and to scroll through the installed sensors.

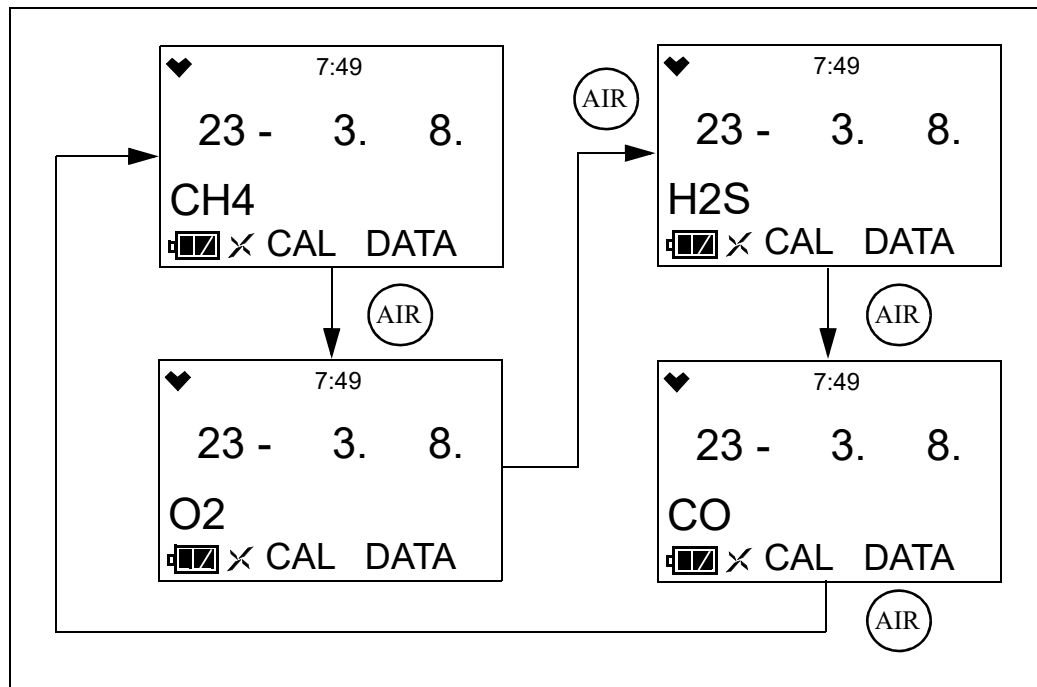

3. When you are done viewing the last calibration date for the sensors, press **POWER MODE** to return to the **CAL DATA** screen in Display Mode.

Last Successful Bump Test Date (BMP.DATA)

The **BMP.DATA** screen shows the date of each installed sensor's last successful bump test. This screen only appears if **BMP.RMDR** is set to **ON**.

1. While in Measuring Mode, press POWER MODE until **BMP.DATA** appears.

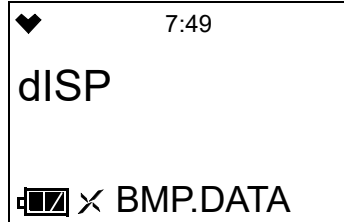

2. Press AIR to enter the **BMP.DATA** screen and to scroll through the installed sensors.

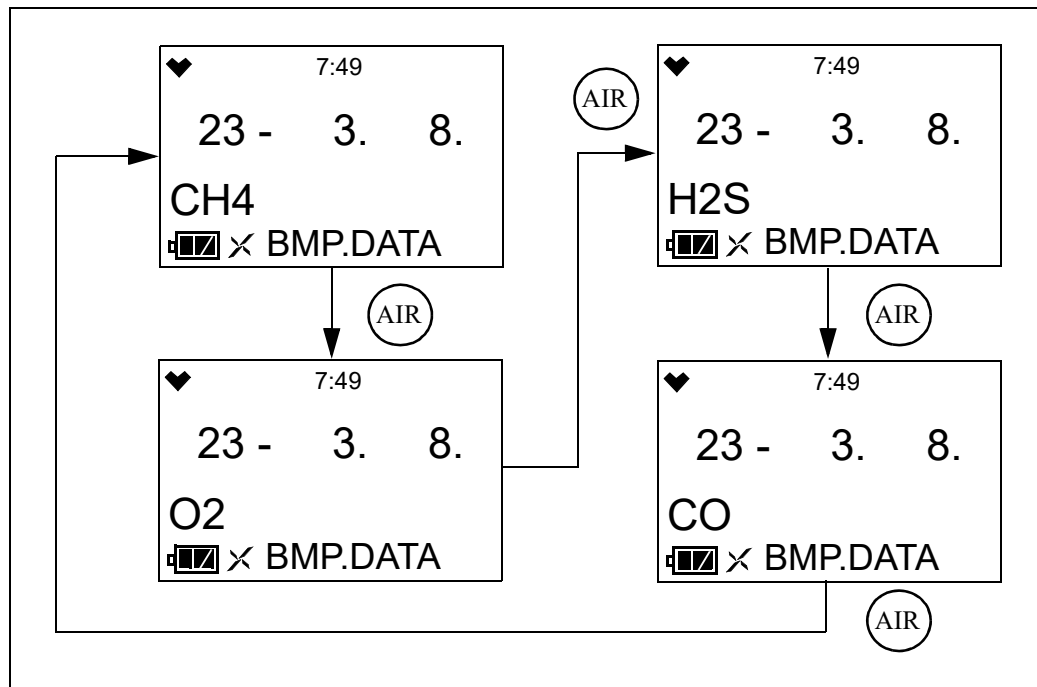

3. When you are done viewing the last bump test date for the sensors, press POWER MODE to return to the **BMP.DATA** screen in Display Mode.

Viewing Snap Log Data (REC.DATA)

The **REC.DATA** screen shows the date and measurement data for each snap log saved on the instrument.

1. While in Measuring Mode, press **POWER MODE** until **REC.DATA** appears.

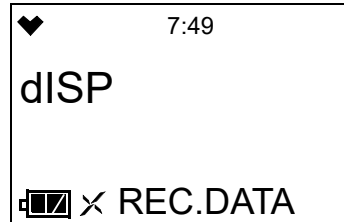

2. Press **AIR** to enter the **REC.DATA** screen and to scroll through the saved snap logs. Press **POWER MODE** to view the desired snap log's details.

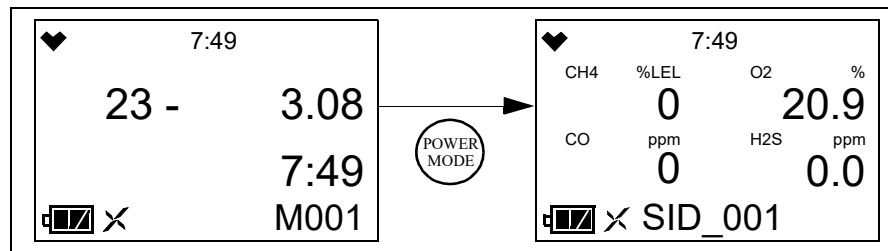

3. When finished viewing the instrument's snap log data, press **AIR** and **POWER MODE** together to return to the **REC.DATA** screen in Display Mode.

Date, Time, Temperature Screen (TEMP)

The **TEMP** screen shows the instrument's date and time and the surrounding area's temperature.

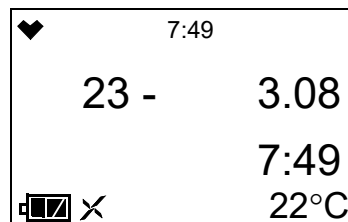

Alarm Points Screen (ALARM--P)

The Alarm Points Screen shows the gas alarm settings for all active channels.

1. While in Measuring Mode, press POWER MODE until **ALARM--P** appears.



2. Press AIR. The Full Scale Settings screen appears and shows full scale settings for each channel.
3. Use AIR to scroll through the Warning, Alarm, Alarm H, STEL, and TWA settings.

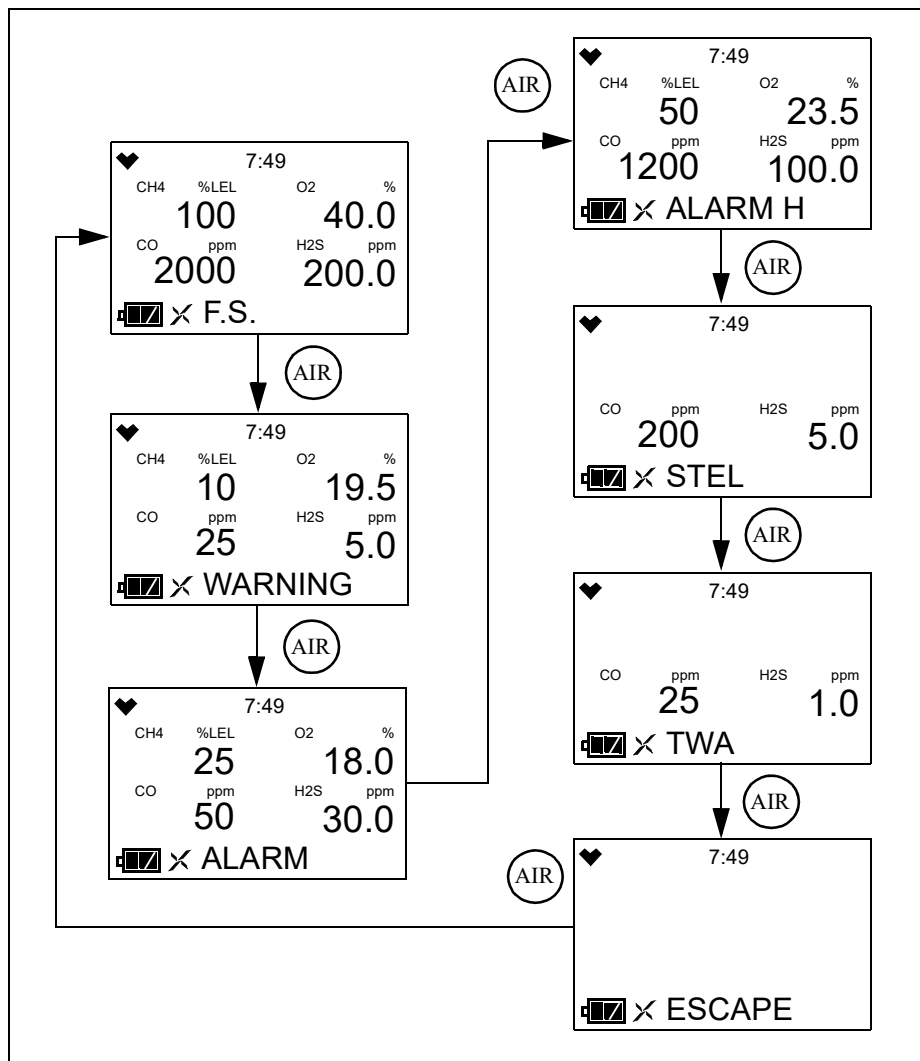

4. While viewing the alarm settings for an alarm point, press AIR and POWER MODE at the same time to simulate the alarm conditions. The buzzer will sound, the LEDs will flash, and the instrument will vibrate just as it would if the displayed condition was actually happening.
5. Press POWER MODE to return to the Alarm Points Screen.

Chapter 5: User Mode and Calibration

Overview

This section describes the GX-Force in User Mode. See Table 11 for a list of the items found in User Mode, the page that the menu item's instructions can be found on, and a short description of the menu item.

Table 11: User Mode Menu Items

User Mode Menu Item	Description			
BUMP (page 63)	Perform a bump test.			
	BUMP CYL X	Perform a bump test on the gases selected for Cylinder X (A-E cylinders available)		
	START	Begin the warmup sequence and enter Measuring Mode.		
	ESCAPE	Return to the BUMP menu item.		
GAS CAL (page 70)	Perform a fresh air adjustment, perform a span adjustment, change the calibration gas concentration, set the cylinder group.			
	AIR CAL (page 70)	Perform a fresh air adjustment.		
	AUTO.CAL (page 71)	AUTO.CAL CYL X	Perform an automatic span adjustment on the gases selected for Cylinder X (A-E cylinders available).	
		START	Begin the warmup sequence and enter Measuring Mode.	
		CAL--P	Set the calibration gas concentration for each gas.	
		CYL SEL	Assign a cylinder (A-E) to each gas (all 4 gases set to Cylinder A is the default). For single cal operation, you would assign each gas its own cylinder.	
		ESCAPE	Return to the AUTO.CAL menu item.	
	ESCAPE	Return to the GAS CAL menu item.		

Table 11: User Mode Menu Items

User Mode Menu Item	Description	
CAL SET (page 81)	Change calibration parameters.	
	CAL.RMDR (page 81)	<p>ON (factory setting): The instrument notifies the user upon startup when a calibration is due. Notification type depends on CAL.EXPD setting below.</p> <p>OFF: No notification upon startup when a calibration is due.</p>
	CAL.INT (page 82)	<p>How often the instrument needs to be calibrated.</p> <p>Options: 1 - 1000 days (factory setting is 90 days)</p>
CAL SET (page 81) cont.	CAL.EXPD (page 82)	<p>Defines what action must be taken if a calibration is due upon startup.</p> <p>CONFIRM (factory setting): press AIR to acknowledge that calibration is due and continue to Measuring Mode.</p> <p>CANT USE: Cannot enter Measuring Mode until a successful calibration is performed.</p> <p>NONE: A screen indicates that calibration is due but warmup sequence continues.</p>
	ESCAPE	Return to the CAL SET menu item in User Mode.

Table 11: User Mode Menu Items

User Mode Menu Item	Description		
BUMP.SET (page 83)	Change bump test parameters.		
	SETTING (page 83)	GAS.TIME	How long gas is applied during a bump test. Choices: 30 (factory setting), 45 , 60 , 90 seconds
		CHECK	Percentage of calibration gas concentration that the bump test reading must be within in order to pass bump. Options: 10% , 20% , 30% , 40% , 50% (factory setting)
		CAL.TIME	How long gas is applied during a calibration. GAS.TIME is deducted from this time. Options: 90 (factory setting) or 120 seconds
		AUTO.CAL	ON (factory setting): If a bump test fails, a calibration automatically starts. OFF : If a bump test fails, a calibration does not automatically start.
	ESCAPE	Return to the SETTING menu item in BUMP.SET .	
	BMP.RMDR (page 86)	ON : The instrument notifies the user upon startup when a bump test is due. Notification type depends on BMP.EXPD setting below. OFF (factory setting): No notification upon startup when a bump test is due.	
BMP.INT (page 86)	How often the instrument needs to be bump tested. Options: 0 - 30 days (factory setting is 30 days)		
BUMP.SET (page 83) cont.	BMP.EXPD (page 87)	Defines what action must be taken if a bump test is due upon startup. CONFIRM (factory setting): Press AIR to acknowledge that bump test is due and continue to Measuring Mode. CANT USE : Cannot enter Measuring Mode until a successful bump test is performed. NONE : A screen indicates that bump test is due but warmup sequence continues.	
	ESCAPE	Return to the BUMP.SET menu item in User Mode.	
ALARM -- P (page 87)	Set alarm points for all channels (WARNING , ALARM , ALARM H , STEL , TWA) or reset all alarms to their default settings (DEF.ALMP).		
	ESCAPE	Return to the ALARM--P menu item in User Mode.	

Table 11: User Mode Menu Items

User Mode Menu Item	Description	
LUNCH (page 90)	<p>ON: Lunch break feature is on. Instrument asks if you want to resume TWA and PEAK readings at startup.</p> <p>OFF (factory setting): Lunch break feature is off. Instrument resets TWA and PEAK readings every time it's turned on.</p>	
BEEP (page 91)	Set confirmation beep parameters.	
	BEEP.SEL (page 91)	<p>LED: LEDs flash and instrument vibrates based on interval defined in BEEP.INT to confirm instrument is still operating.</p> <p>BUZZER: Buzzer sounds and instrument vibrates based on interval defined in BEEP.INT to confirm instrument is still operating.</p> <p>LED+BUZZ: LEDs flash, buzzer sounds, and instrument vibrates based on interval defined in BEEP.INT to confirm instrument is still operating.</p> <p>BUMP/CAL: LEDs flash based on interval defined in BEEP.INT if bump test or calibration is due.</p> <p>ALM.ALRT: LEDs flash based on interval defined in BEEP.INT if instrument goes into a gas alarm.</p>
	BEEP.SEL (page 91) cont.	<p>B/C/ALM: LEDs flash based on interval defined in BEEP.INT if a) bump test is due, b) calibration is due, or c) instrument goes into a gas alarm.</p> <p>OFF (factory setting): No alerts to confirm instrument is still operating or that a bump test or calibration is due.</p>
	BEEP.INT (page 92)	Confirmation alert interval. Confirmation type defined in BEEP.SEL. Options: 0.5 minute and 1 to 99 minutes in 1 minute increments. The factory setting is 5 minutes.
	ESCAPE	Return to the BEEP menu item in User Mode.
BL TIME (page 93)	<p>How long the back light stays on after the last button press</p> <p>Options: 0 - 255 seconds or OFF. The factory setting is 30 seconds.</p>	
KEY.TONE (page 93)	<p>ON (factory setting): Buzzer sounds when button is pressed.</p> <p>OFF: Buzzer does not sound when button is pressed.</p>	
DISP.SET (page 94)	<p>OFF: LIST, USER ID, STN ID, and PUMP.OFF screens do not appear in Display Mode.</p> <p>ON (factory setting): LIST item appears in Display Mode. USER ID and STN ID screens appear if ID DISP in Maintenance Mode is also set to ON. The PUMP.OFF screen appears if POFF.DISP in Maintenance Mode is also set to ON.</p>	

Table 11: User Mode Menu Items

User Mode Menu Item	Description
ZERO.SUP (page 94)	ON (factory setting): Not intended for field adjustment. The suppression values are: Combustible Gas: 2% LEL O ₂ : 0.5% volume H ₂ S: 0.3 ppm CO: 2 ppm <i>NOTE: Only appears if ZSUP.DISP is set to ON in Maintenance Mode</i>
ZERO.FLW (page 94)	ON (factory setting): Not intended for field adjustment. Oxygen channel does not support zero follower functionality. <i>NOTE: Only appears if ZFLW.DISP is set to ON in Maintenance Mode</i>
DATE (page 95)	Set the instrument's date and time.
PASS - - W (page 95)	ON : User Mode is password-protected. Factory-set password is 0000. OFF (factory setting): User Mode is not password-protected.
ROM/SUM (page 96)	Displays the GX-Force's sensor and main ROM/SUM numbers
START (page 97)	Press POWER MODE to begin the warmup sequence and enter Measuring Mode.

Tips for Using User Mode

- To scroll from one menu item to the next, press AIR. To reverse the scrolling direction:
 - a. Press and hold AIR.
 - b. Immediately press POWER/MODE and then release both buttons.
 - c. The scrolling direction returns to the original direction when you exit and reenter a menu.
- To skip an item when a question is asked, press AIR.
- To enter an item and to save any changes, press POWER MODE.
- To change a flashing parameter, press AIR. To reverse the direction of change (ie. from increasing to decreasing or vice versa):
 - a. Press and hold AIR.
 - b. Immediately press POWER MODE and then release both buttons.
- To exit an entered menu item without saving a change, press and hold AIR and POWER MODE for a few seconds.

Entering User Mode

WARNING: *The GX-Force is not in operation as a gas detector while in User Mode.*

1. Take the GX-Force to a non-hazardous location and turn it off if it is on.
2. Press and hold AIR, then press and hold POWER MODE. When the instrument beeps once, release the buttons.
3. The screen that appears depends on the **PASS - - W** setting in User Mode.
 - If **PASS - - W** is set to **OFF** (factory setting), continue to Step 6.
 - If **PASS - - W** is set to **ON**, continue to Step 4.

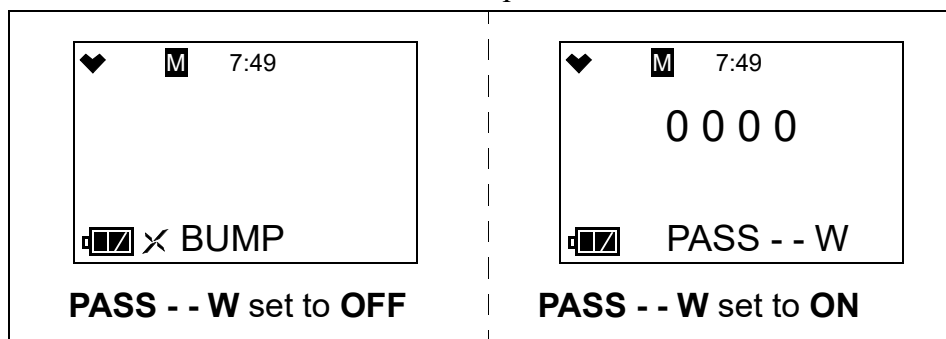

4. If **PASS - - W** has been set to **ON** in User Mode, a password screen appears. The first digit is flashing.
5. Use AIR to select each password number then press POWER MODE to save it and move on to the next number. To go back a number, press and hold AIR and POWER MODE for a few seconds. To reverse the direction of change (ie. from increasing to decreasing or vice versa):
 - a. Press and hold AIR.
 - b. Immediately press POWER MODE and then release both buttons.
6. The **BUMP** menu item appears.

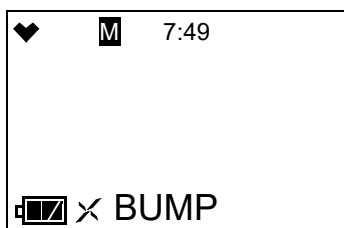

7. **M** at the top of the screen indicates that the GX-Force is in User Mode.
8. Use AIR to move through the User Mode menu items.

Performing a Bump Test (BUMP)

Bump test the instrument before each day's use with a known concentration of each target gas. The instrument does not need to be calibrated unless it does not pass the bump test.

To bump test the GX-Force, you will need:

- Known calibrating samples of the gases being detected.

Table 12: Calibration Concentration Limits

Channel	Min. Cal. Gas Concentration	Max. Cal. Gas Concentration
Combustible Gas	1% LEL	75% LEL
Oxygen	0.0%	17.0%
Hydrogen Sulfide	0.5 ppm	200.0 ppm
Carbon Monoxide	12 ppm	2,000 ppm

- Demand flow regulator
 - Non-absorbent tubing
 - Sample hose and probe (if used during normal operation)
1. Confirm that the GX-Force's calibration gas values match the concentrations listed on the calibration gas cylinder(s) as described on page 76.
 2. Confirm that your cylinder selections are appropriate as described on page 79.
 3. Install the demand flow regulator onto the calibration cylinder.
 4. Connect the sample tubing to the demand flow regulator.
 5. If used during normal operation, install the sample hose and probe onto the GX-Force inlet fitting.

Make sure the probe's two halves are tightened firmly together to avoid leaks that can affect the calibration.

6. While in User Mode, press AIR to scroll to **BUMP**.

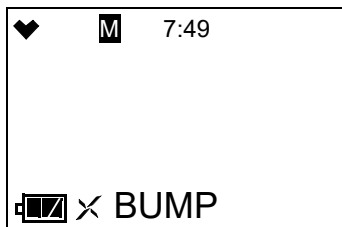

- Press POWER MODE. The display shows the gases assigned to Cylinder A and their assigned bump test values (see page 76 if the bump test values do not match the calibration gas cylinder's concentrations). The bottom of the screen alternates between "CYL A" and "BUMP".

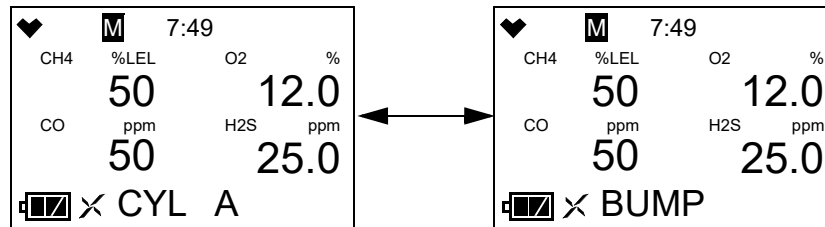

- If necessary, use AIR to scroll to the Bump screen for the gas(es) you want to bump test. As shipped from the factory, combustible gas, O₂, H₂S, and CO are assigned to Cylinder A. If an H₂-compensated CO sensor is installed, H₂ is assigned to Cylinder D, but there is no reason to bump test the H₂ response.
- Make sure the GX-Force has been turned on for at least 45 seconds before continuing.
- Connect the sample tubing from the demand flow regulator to either the GX-Force's inlet fitting or the rigid tube on the probe (if in use) then quickly press POWER MODE to begin the bump test countdown.
- The gas readings flash, the bottom of the screen alternates between "APPLY" and "BUMP", and the top of the screen counts down from the time set in BUMP.SET\SETTING\GAS.TIME.

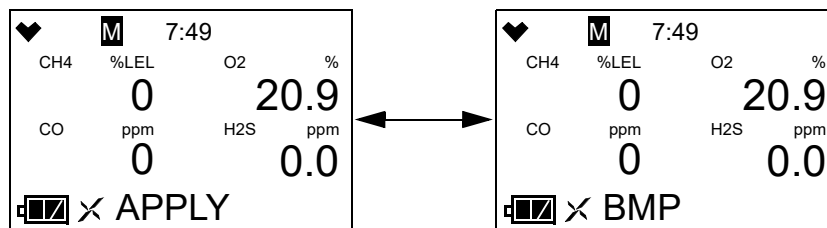

NOTE: To back out of the gas application screen without performing the bump test, press AIR and POWER MODE together.

12. At the end of the countdown, the instrument analyzes the results. Follow the flow chart to determine the bump test outcome.

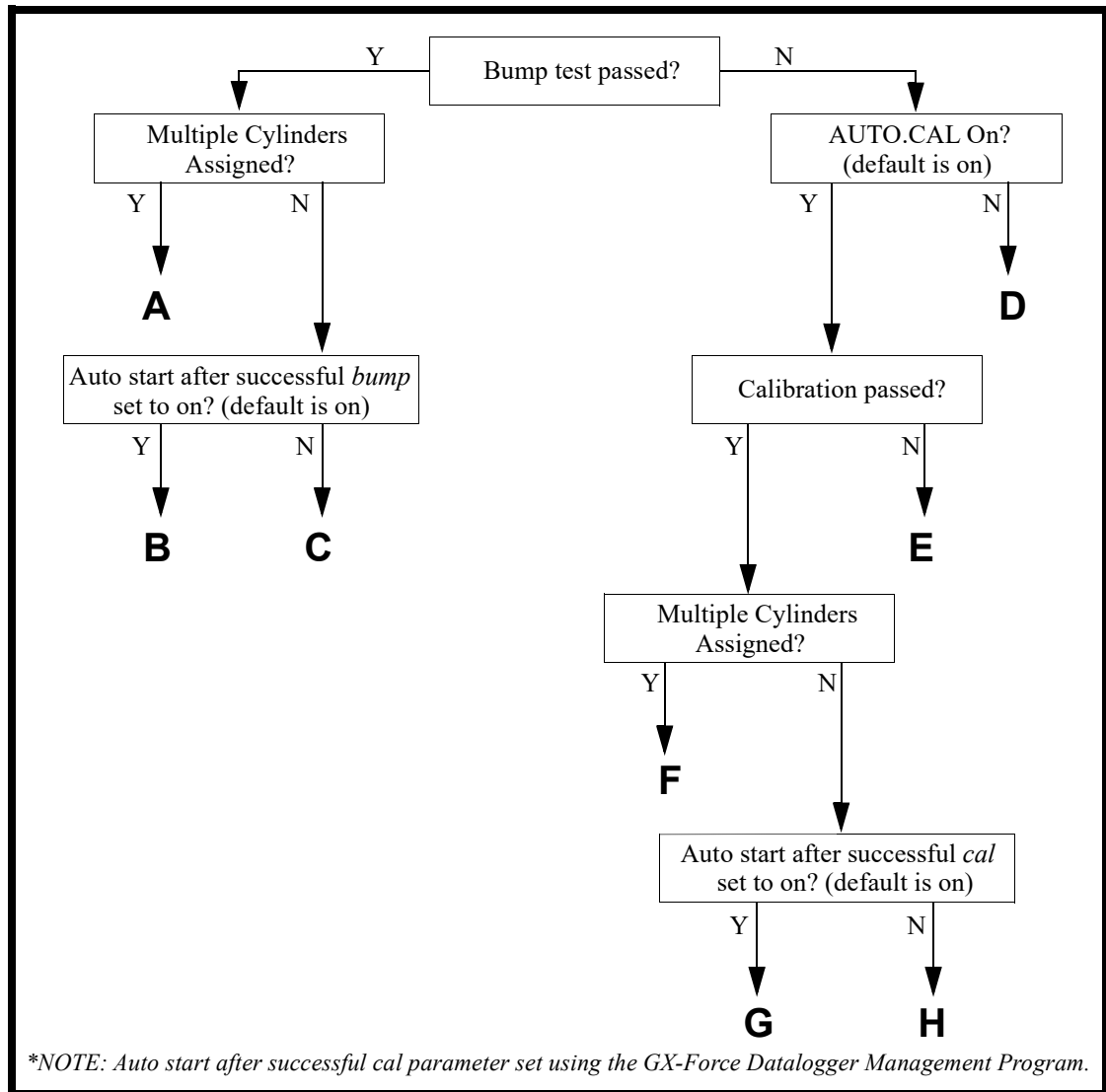
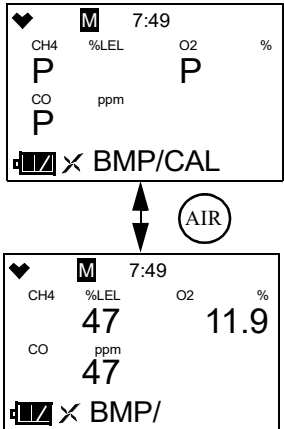
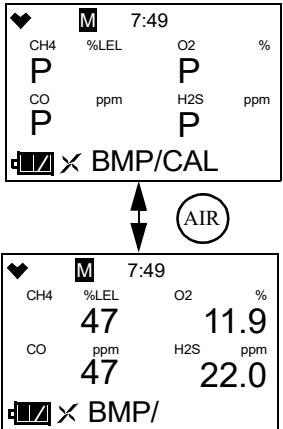
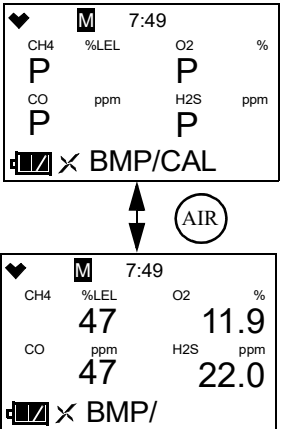
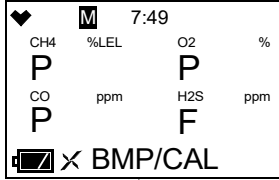
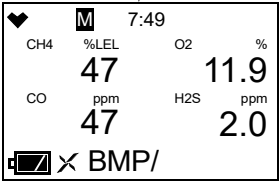
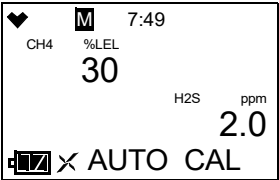
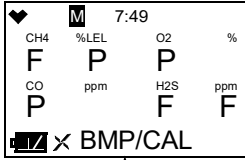
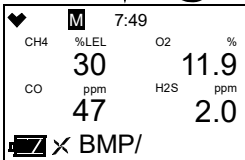
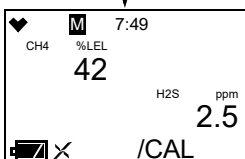

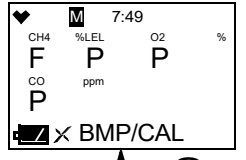
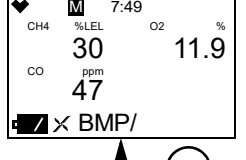
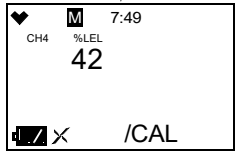
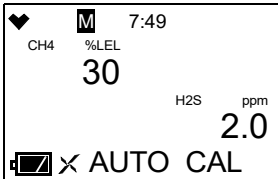
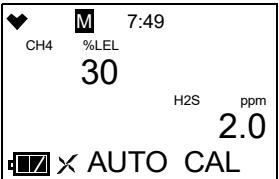
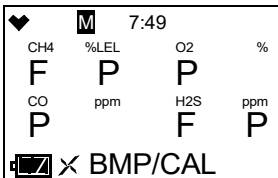
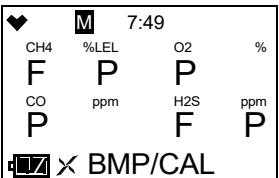
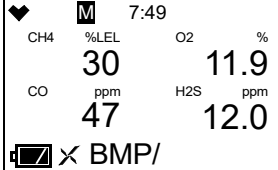
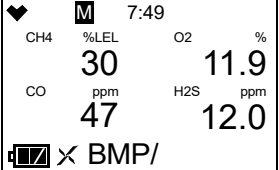
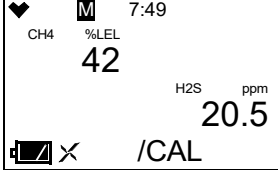
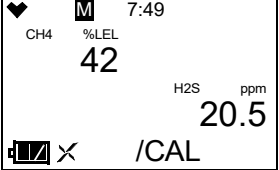

Figure 6: Bump Test Flow Chart

Option A from Flow Chart	Option B from Flow Chart	Option C from Flow Chart
<ul style="list-style-type: none"> • Bump test passed • Multiple cylinders assigned 	<ul style="list-style-type: none"> • Bump test passed • One cylinder assigned • Auto Start After Successful Bump set to ON (factory setting) 	<ul style="list-style-type: none"> • Bump test passed • One cylinder assigned • Auto Start After Successful Bump set to OFF (factory setting is ON)
<p>1. The instrument indicates that all channels passed the bump test. Use AIR to scroll between the bump test results and the bump test gas readings.</p> <div style="text-align: center;">  <p>The diagram shows two screenshots of the instrument display. The top screenshot shows the 'BMP/CAL' screen with 'P' indicators for CH4, %LEL, O2, and CO. The bottom screenshot shows the 'BMP/' screen with numerical values: CH4 47, %LEL 47, O2 11.9, and H2S 22.0. A double-headed vertical arrow and a circle labeled 'AIR' indicate the scroll action between the two screens.</p> </div> <ol style="list-style-type: none"> 2. Disconnect the tubing from the probe. 3. Press POWER MODE to move to the BUMP CYL X screen for the next cylinder. 4. Unscrew the demand flow regulator from the first cylinder and screw it into the next cylinder. 5. Repeat Step 10 through Step 12. 6. After the last cylinder is bump tested, press POWER MODE to go to the START item in the BUMP menu. 7. Disconnect the tubing from the probe. 8. Unscrew the regulator. 9. Press POWER MODE to enter Measuring Mode. 	<p>1. The instrument indicates that all channels passed the bump test. Use AIR to scroll between the bump test results and the bump test gas readings.</p> <div style="text-align: center;">  <p>The diagram shows two screenshots of the instrument display. The top screenshot shows the 'BMP/CAL' screen with 'P' indicators for CH4, %LEL, O2, CO, and H2S. The bottom screenshot shows the 'BMP/' screen with numerical values: CH4 47, %LEL 47, O2 11.9, CO 47, and H2S 22.0. A double-headed vertical arrow and a circle labeled 'AIR' indicate the scroll action between the two screens.</p> </div> <ol style="list-style-type: none"> 2. Disconnect the tubing from the probe. 3. Unscrew the demand flow regulator from the calibration cylinder. 4. Press POWER MODE to enter Measuring Mode. 	<p>1. The instrument indicates that all channels passed the bump test. Use AIR to scroll between the bump test results and the bump test gas readings.</p> <div style="text-align: center;">  <p>The diagram shows two screenshots of the instrument display. The top screenshot shows the 'BMP/CAL' screen with 'P' indicators for CH4, %LEL, O2, CO, and H2S. The bottom screenshot shows the 'BMP/' screen with numerical values: CH4 47, %LEL 47, O2 11.9, CO 47, and H2S 22.0. A double-headed vertical arrow and a circle labeled 'AIR' indicate the scroll action between the two screens.</p> </div> <ol style="list-style-type: none"> 2. Disconnect the tubing from the probe. 3. Unscrew the demand flow regulator from the calibration cylinder. 4. Press POWER MODE to return to the START item in the BUMP menu. 5. Press POWER MODE to enter Measuring Mode.

Option D from Flow Chart	Option E from Flow Chart	Option F from Flow Chart
<ul style="list-style-type: none"> • Bump test failed • A-CAL set to OFF (factory setting is ON) 	<ul style="list-style-type: none"> • Bump test failed • A-CAL set to ON (factory setting) • Calibration failed 	<ul style="list-style-type: none"> • Bump test failed • A-CAL set to ON (factory setting) • Calibration passed • Multiple cylinders assigned
<p>1. The instrument shows which channels passed or failed the bump test. The LEDs flash and the buzzer sounds. Use AIR to scroll between the results and the readings.</p>   <p>2. Disconnect the tubing from the probe.</p> <p>3. Unscrew the demand flow regulator from the calibration cylinder.</p> <p>4. Press POWER MODE to return to the BUMP CYL A item in the BUMP menu.</p> <p>5. Use AIR to scroll to START and Press POWER MODE to enter Measuring Mode.</p> <p>6. Calibrate the GX-Force as soon as possible.</p>	<p>1. A calibration immediately and automatically starts. Continue to apply the calibration gas.</p> <p>2. The calibration time is the difference between the GAS.TIME and the CAL.TIME values defined in the BUMP.SET\SETTING item in User Mode.</p>  <p>3. The instrument shows which channels passed or failed the bump test/calibration. The LEDs flash and the buzzer sounds. Use AIR to scroll between the results and the readings.</p>    <p>4. Disconnect the tubing from the probe.</p> <p>5. Unscrew the demand flow regulator from the calibration cylinder.</p> <p>6. Press POWER MODE to return to the BUMP CYL A item in the BUMP menu.</p> <p>7. Use AIR to scroll to START and press POWER MODE to enter Measuring Mode.</p>	<p>1. A calibration immediately and automatically starts. Continue to apply the calibration gas.</p> <p>2. The calibration time is the difference between the GAS.TIME and the CAL.TIME values defined in the BUMP.SET\SETTING item in User Mode.</p>  <p>3. The instrument shows which channels passed or failed the bump test/calibration. Use AIR to scroll between the results and the readings.</p>    <p>4. Disconnect the tubing from the probe.</p> <p>5. Press POWER MODE to move to the BUMP CYL X screen for the next cylinder.</p> <p>6. Unscrew the demand flow regulator from the first cylinder and screw it into the next cylinder.</p> <p>7. Repeat Step 10 through Step 12.</p> <p>8. After the last cylinder is bump tested, press POWER MODE to go to the START item in the BUMP menu.</p> <p>9. Unscrew the regulator.</p> <p>10. Press POWER MODE to enter Measuring Mode.</p>

Option G from Flow Chart	Option H from Flow Chart
<ul style="list-style-type: none"> • Bump test failed • A-CAL set to ON (factory setting) • Calibration passed • One cylinder assigned • Auto Start After Successful Cal set to ON (factory setting) 	<ul style="list-style-type: none"> • Bump test failed • A-CAL set to ON (factory setting) • Calibration passed • One cylinder assigned • Auto Start After Successful Cal set to OFF (factory setting is ON)
<ol style="list-style-type: none"> 1. A calibration immediately and automatically starts. Continue to apply the calibration gas. 2. The calibration time is the difference between the GAS.TIME and the CAL.TIME values defined in the BUMP.SET\SETTING item in User Mode. 	<ol style="list-style-type: none"> 1. A calibration immediately and automatically starts. Continue to apply the calibration gas. 2. The calibration time is the difference between the GAS.TIME and the CAL.TIME values defined in the BUMP.SET\SETTING item in User Mode.
	
<ol style="list-style-type: none"> 3. The instrument shows which channels passed or failed the bump test/calibration. Use AIR to scroll between the results and the readings. 	<ol style="list-style-type: none"> 3. The instrument shows which channels passed or failed the bump test/calibration. Use AIR to scroll between the results and the readings.
	
<p style="text-align: center;">↕ (AIR)</p>	<p style="text-align: center;">↕ (AIR)</p>
	
<p style="text-align: center;">↕ (AIR)</p>	<p style="text-align: center;">↕ (AIR)</p>
	
<ol style="list-style-type: none"> 4. Disconnect the tubing from the probe. 5. Unscrew the demand flow regulator from the calibration cylinder. 6. Press POWER MODE to enter Measuring Mode. 	<ol style="list-style-type: none"> 4. Disconnect the tubing from the probe. 5. Unscrew the demand flow regulator from the calibration cylinder. 6. Press POWER MODE to return to the START item in the BUMP menu. 7. Press POWER MODE to enter Measuring Mode.

Performing a Calibration (GAS CAL)

Calibration Notes

- To fully calibrate the sensors, you must do a fresh air adjustment (**AIR CAL**) and a span adjustment (**AUTO.CAL**).
- Bump test the instrument before each day's use with a known concentration of each target gas. A bump test can be done in User Mode's **BUMP** item or by applying gas in Measuring Mode. The instrument does not need to be calibrated unless it does not pass the User Mode bump test or does not respond appropriately, as defined by the user, in Measuring Mode.
- The hydrogen response for the H₂-compensated CO sensor needs to be calibrated both monthly and when the sensor is replaced.

AIR CAL

1. Find a fresh air environment, an environment of normal oxygen content (20.9%) that is free of toxic and combustible gases.
2. While in User Mode, press AIR to scroll to **GAS CAL**.

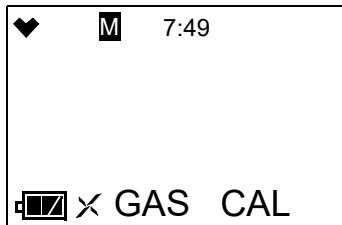

3. Press POWER MODE. The **AIR CAL** menu item appears.

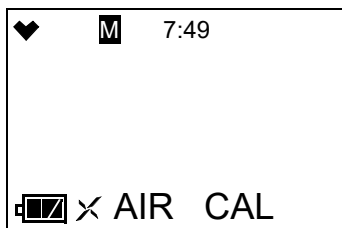

4. Press POWER MODE to enter the **AIR CAL** menu.

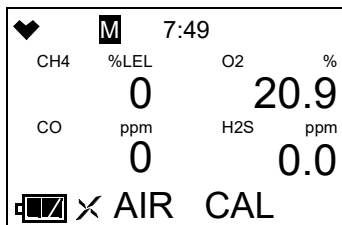

5. Make sure the GX-Force has been turned on for at least 45 seconds before continuing.

- Press and hold AIR until the screen prompts you to release it.

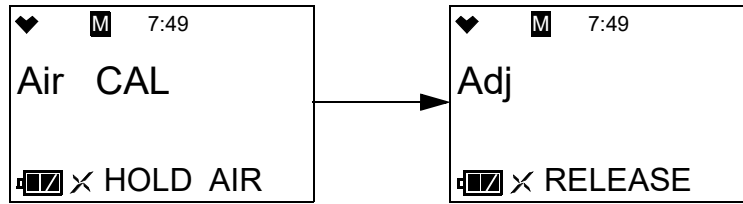

- If the fresh air adjustment passes, the instrument returns to the **GAS CAL** menu.
- If the fresh air adjustment fails, “**FAIL AIR**” displays. Press POWER MODE to acknowledge the failure. See “Troubleshooting” on page 98.

Performing a Span Adjustment in AUTO.CAL

Preparing for a Span Adjustment

To adjust the span on the GX-Force, you will need the following:

- Known concentrations of the gases being detected

Table 13: Calibration Concentration Limits

Channel	Min. Cal. Concentration	Max. Cal. Concentration
Combustible Gas	1% LEL	75% LEL
Oxygen	0.0%	17.0%
Hydrogen Sulfide	0.5 ppm	200.0 ppm
Carbon Monoxide	12 ppm	2,000 ppm
Hydrogen (for H ₂ -compensated CO sensor); needs monthly calibration	25 ppm	2,000 ppm

- Demand flow regulator
 - Non-absorbent tubing
 - Sample hose and probe (if used during normal operation)
- Confirm that the GX-Force’s calibration gas values match the concentrations listed on the calibration gas cylinder(s) as described on page 76.
 - Confirm that your cylinder selections are appropriate as described on page 79.
 - Install the demand flow regulator onto the 3-gas or 4-gas calibration cylinder.
 - Connect the sample tubing to the demand flow regulator.
 - If used during normal operation, install the sample hose and probe onto the GX-Force inlet fitting.

Make sure the probe’s two halves are tightened firmly together to avoid leaks that can affect the calibration.

Performing a Span Adjustment

1. While in User Mode, press AIR to scroll to **GAS CAL**.

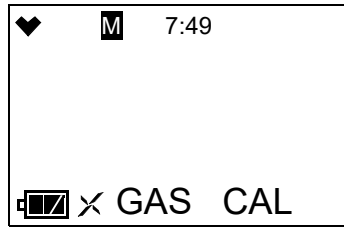

2. Press POWER MODE. The **AIR CAL** menu item appears.
3. Use AIR to scroll to the **AUTO.CAL** menu item.

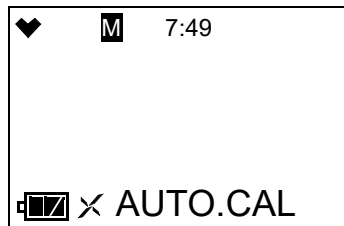

4. Press POWER MODE. The display shows the gases assigned to Cylinder A and their assigned calibration values (see page 76 if the calibration values do not match the calibration gas cylinder's concentrations). The bottom of the screen alternates between "**CYL A**" and "**AUTO.CAL**".

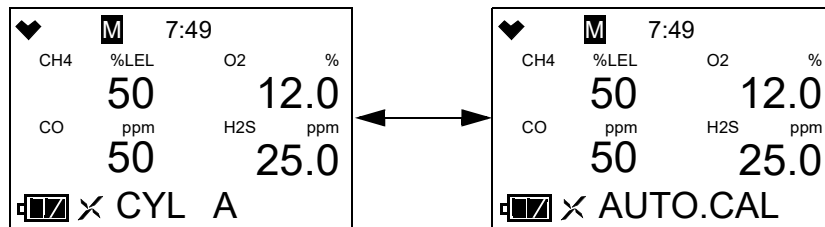

5. If necessary, use AIR to scroll to the **AUTO.CAL** screen for the gas(es) you want to calibrate. As shipped from the factory, combustible gas, O₂, H₂S, and CO are assigned to Cylinder A. If an H₂-compensated CO sensor is installed, H₂ is assigned to Cylinder D.
6. Make sure the GX-Force has been turned on for at least 45 seconds before continuing.
7. Connect the tubing from the demand flow regulator to either the GX-Force's inlet fitting or the rigid tube on the probe (if in use) then quickly press POWER MODE to begin the span adjustment countdown.

8. The gas readings flash and the bottom of the screen alternates between “**APPLY**” and “**AUTO.CAL**”.

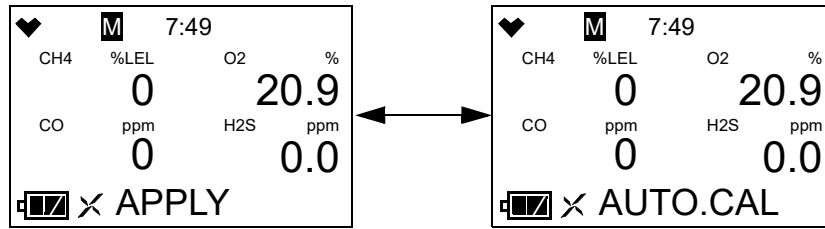

NOTE: To back out of the gas application screen without performing the bump test, press AIR and POWER MODE together.

9. Allow the gas to flow for 1 minute.
 10. Press POWER MODE.
 11. Follow the flow chart to determine the calibration outcome.

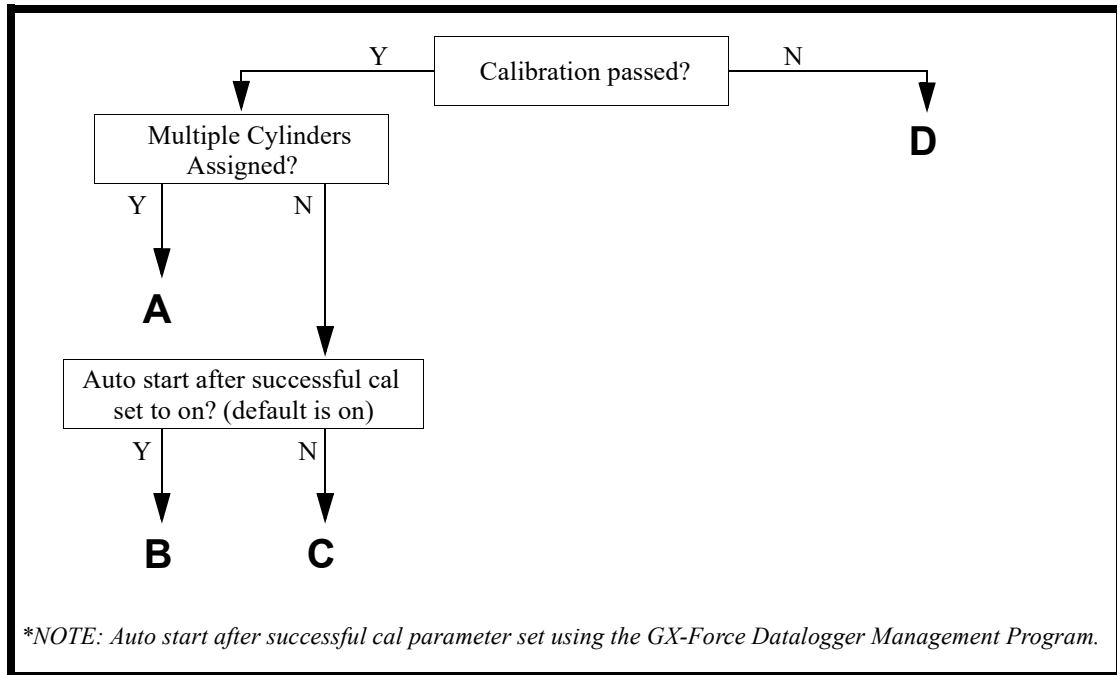
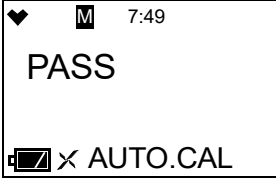
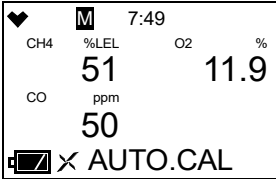
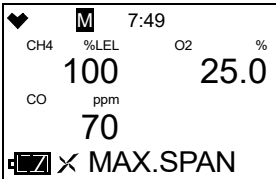
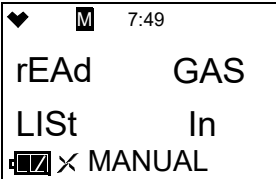
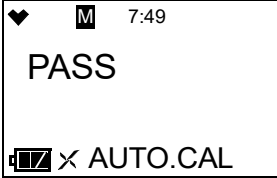
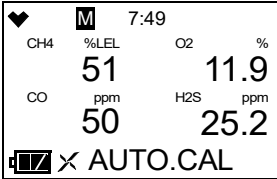
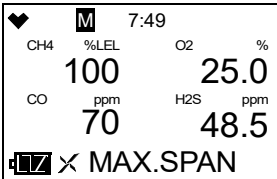
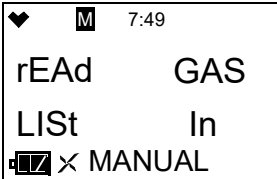
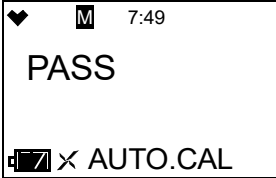
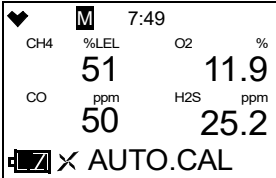
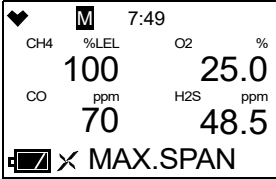
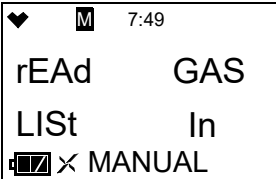
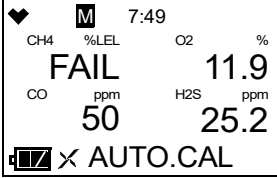

Figure 7: Calibration Flow Chart

Option A from Flow Chart	Option B from Flow Chart
<ul style="list-style-type: none"> • Calibration passed • Multiple cylinders assigned 	<ul style="list-style-type: none"> • Calibration passed • One cylinder assigned • Auto Start After Successful Cal set to ON (factory setting)
<ol style="list-style-type: none"> The instrument indicates that all channels passed the calibration.  The instrument shows the current gas readings.  If MAX.SPAN is set to ON (default is OFF, see page 130), the response reading's max adjustment is displayed. A max span of 100% LEL on the combustible channel indicates that the reading could have been adjusted up to 100% LEL. If the max span value is close to the calibration gas value, the sensor should be replaced soon. The max adjustment is either twice the calibration value or full scale, whichever is lower. The max adjustment indicated for the oxygen channel is 25.0% volume.  If the combustible gas sensor is nearing expiration, Display Mode's LIST item becomes limited. Press POWER MODE to acknowledge. See page 39 for a description of the HC Gas List condition and page 47 for the limited conversion list.  <ol style="list-style-type: none"> Disconnect the tubing from the probe. The instrument continues to the AUTO.CAL CYL X screen. Unscrew the regulator from the first cylinder and screw it into the next cylinder. Press POWER MODE to start the next cylinder's calibration. Repeat Step 9 through Step 11. After the last cylinder is calibrated, the instrument continues to the START item in the AUTO.CAL menu. Disconnect the tubing from the probe. Unscrew the regulator. Press POWER MODE to enter Measuring Mode. 	<ol style="list-style-type: none"> The instrument indicates that all channels passed the calibration.  The instrument shows the current gas readings.  If MAX.SPAN is set to ON (default is OFF, see page 130), the response reading's max adjustment is displayed. A max span of 100% LEL on the combustible channel indicates that the reading could have been adjusted up to 100% LEL. If the max span value is close to the calibration gas value, the sensor should be replaced soon. The max adjustment is either twice the calibration value or full scale, whichever is lower. The max adjustment indicated for the oxygen channel is 25.0% volume.  If the combustible gas sensor is nearing expiration, Display Mode's LIST item becomes limited. Press POWER MODE to acknowledge. See page 39 for a description of the HC Gas List condition and page 47 for the limited conversion list.  <ol style="list-style-type: none"> Disconnect the tubing from the probe. Unscrew the regulator. The instrument automatically begins its warmup sequence and enters Measuring Mode.

Option C from Flow Chart	Option D from Flow Chart
<ul style="list-style-type: none"> • Calibration passed • One cylinder assigned • Auto Start After Successful Cal set to OFF (factory setting is ON) 	<ul style="list-style-type: none"> • Calibration failed
<ol style="list-style-type: none"> The instrument indicates that all channels passed the calibration.  The instrument shows the current gas readings.  If MAX.SPAN is set to ON (default is OFF, see page 130), the response reading's max adjustment is displayed. A max span of 100% LEL on the combustible channel indicates that the reading could have been adjusted up to 100% LEL. If the max span value is close to the calibration gas value, the sensor should be replaced soon. The max adjustment is either twice the calibration value or full scale, whichever is lower. The max adjustment indicated for the oxygen channel is 25.0% volume.  If the combustible gas sensor is nearing expiration, Display Mode's LIST item becomes limited. Press POWER MODE to acknowledge. See page 39 for a description of the HC Gas List condition and page 47 for the limited conversion list.  Disconnect the tubing from the probe. Unscrew the regulator. The instrument continues to the START item in the AUTO.CAL menu. Press POWER MODE to enter Measuring Mode. 	<ol style="list-style-type: none"> The instrument indicates which channels failed the calibration.  Disconnect the tubing from the probe. Unscrew the regulator. Press POWER MODE to return to the AUTO.CAL CYL X screen in the AUTO.CAL menu. See "Troubleshooting" on page 98.

Setting the Calibration Values in CAL--P

1. While in User Mode, press AIR to scroll to **GAS CAL**.

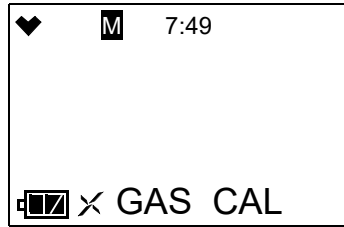

2. Press POWER MODE. The **AIR CAL** menu item appears.
3. Use AIR to scroll to the **AUTO.CAL** menu item.

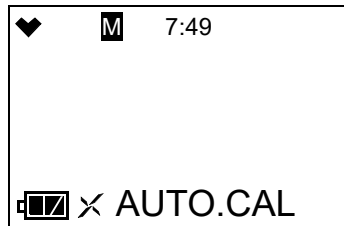

4. Press POWER MODE. The **AUTO.CAL** screen for gases assigned to Cylinder A appears.
5. Use AIR to scroll to **CAL -- P**.

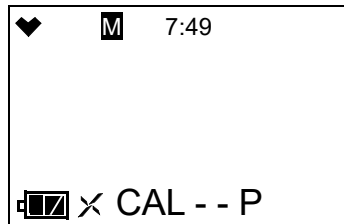

6. Press POWER MODE. The combustible gas channel appears.

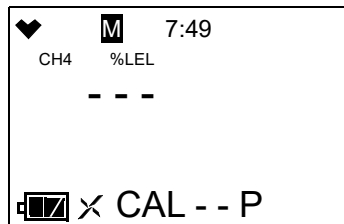

7. Use AIR to scroll to the channel whose calibration gas value you want to change.

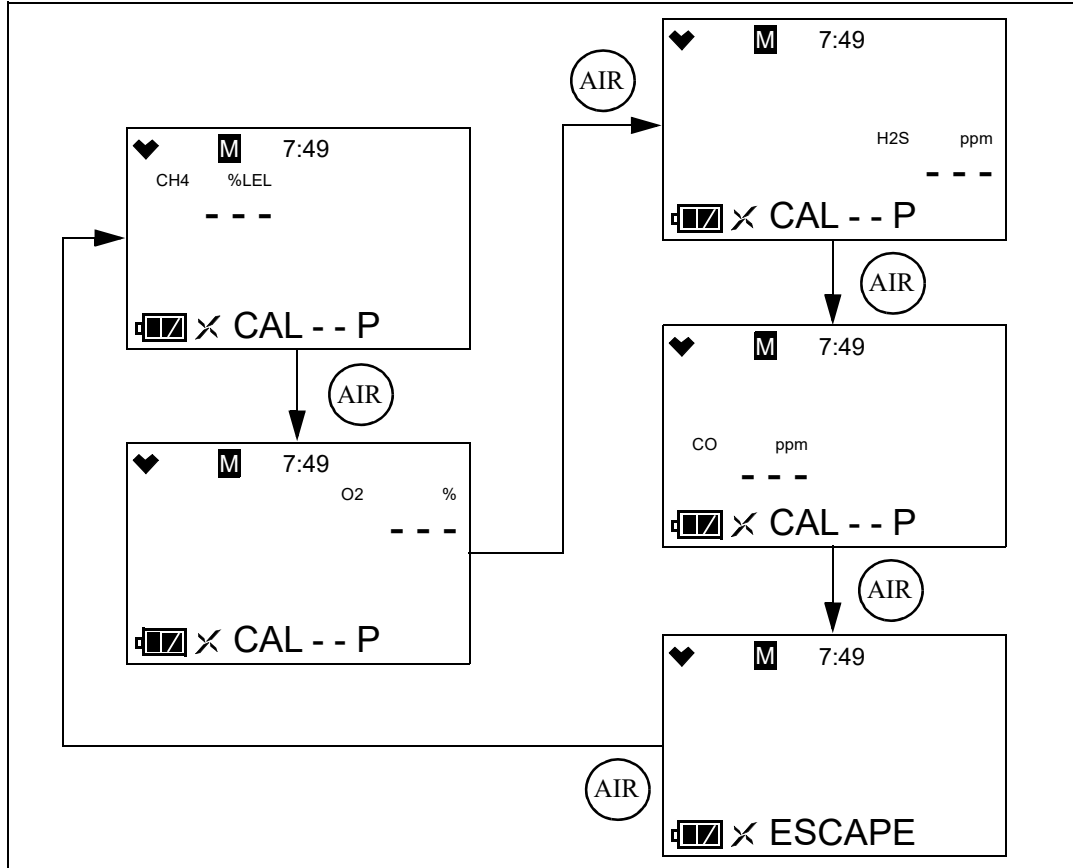

8. Press POWER MODE. The calibration value begins to flash. In the example below, the combustible gas channel is selected.

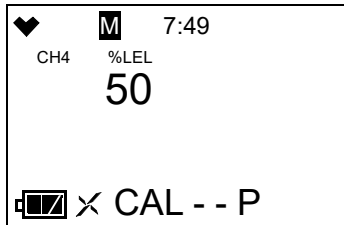

9. Use AIR to adjust the calibration gas value. The calibration gas value in the instrument must match the value listed on the calibration gas cylinder you are using for that channel. Limits on the calibration gas value are shown in Table 14.

Table 14: Calibration Concentration Limits

Channel	Min. Cal. Concentration	Max. Cal. Concentration
Combustible Gas	1% LEL	75% LEL
Oxygen	0.0%	17.0%
Hydrogen Sulfide	0.5 ppm	200.0 ppm
Carbon Monoxide	12 ppm	2,000 ppm
Hydrogen (for H ₂ -compensated CO sensor); needs monthly calibration	25 ppm	2,000 ppm

10. Press POWER MODE to save the change. The calibration gas value stops flashing and the unit returns to the channel selection screen.
11. Repeat Step 7 through Step 10 for any other channels that need to be changed.
12. Use AIR to scroll to **ESCAPE**.
13. Press POWER MODE. The instrument returns to the **CAL--P** menu item in the Auto Cal Menu.
14. Press AIR to scroll to **ESCAPE**.
15. Press POWER MODE. The instrument returns to the **AUTO.CAL** menu item in the **GAS CAL** Menu.
16. See “Exiting the GAS CAL Menu” on page 81 to return to User Mode.

Making Cylinder Selections in CYL SEL

The **CYL SEL** menu item allows you to group channels together for calibration. As shipped from the factory, the standard 4 channels (combustible gas, O₂, H₂S, and CO) are assigned to Cylinder A. As shipped from the factory, the H₂ response for the H₂-compensated CO sensor is assigned to Cylinder D.

There are 5 cylinder assignments available: A, B, C, D, and E. To calibrate each channel separately, assign each channel to a different cylinder (ie. Cylinder A: combustible gas, Cylinder B: O₂, Cylinder C: H₂S, Cylinder D: CO).

1. While in User Mode, press AIR to scroll to **GAS CAL**.

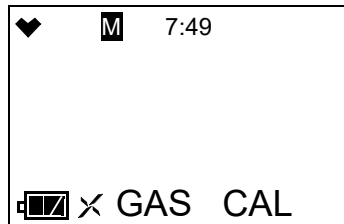

2. Press POWER MODE. The **AIR CAL** menu item appears.
3. Use AIR to scroll to the **AUTO.CAL** menu item.

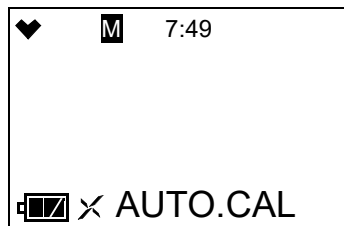

4. Press POWER MODE. The Auto Cal screen for gases assigned to Cylinder A displays.
5. Use AIR to scroll to **CYL SEL**.



6. Press POWER MODE. The combustible gas channel displays.

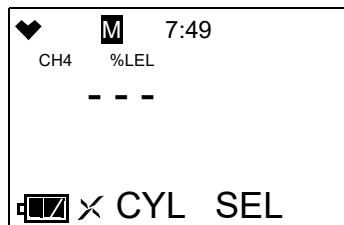

- Use AIR to scroll to the channel whose cylinder assignment you want to change.

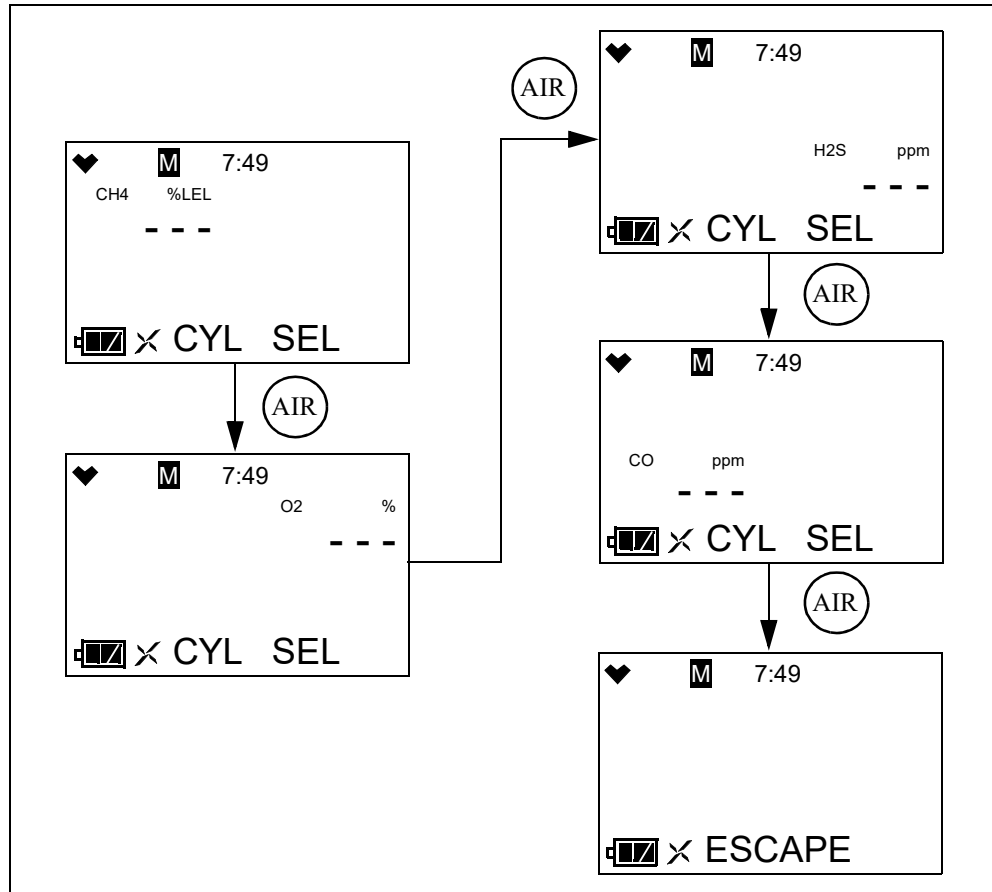

- Press POWER MODE. The current setting flashes. In the example below, the combustible gas channel is selected.

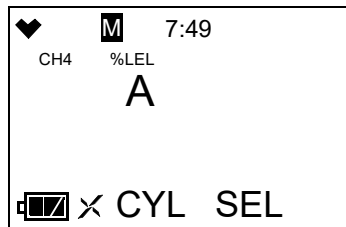

- Use AIR to change the cylinder assignment. The choices are A, B, C, D, and E.
- Press POWER MODE to save the change. The cylinder assignment stops flashing and the unit returns to the channel selection screen.
- Repeat Step 7 through Step 10 for any other channels that need to be changed.
- Use AIR to scroll to **ESCAPE**.
- Press POWER MODE. The instrument returns to the **CYL SEL** menu item in the Auto Cal Menu.
- Press AIR to scroll to **ESCAPE**.

15. Press POWER MODE. The instrument returns to the **AUTO.CAL** menu item in the GAS CAL menu.
16. See “Exiting the GAS CAL Menu” on page 81 to return to User Mode.

Exiting the GAS CAL Menu

1. While in the **GAS CAL** menu, press AIR to scroll to **ESCAPE**.
2. Press POWER MODE. The instrument returns to the **GAS CAL** menu item in User Mode.
3. See “Entering Measuring Mode (START)” on page 97 to enter Measuring Mode.

Setting Calibration Parameters (CAL SET)

The **CAL SET** menu item has 4 items: **CAL.RMDR**, **CAL.INT**, **CAL.EXPD**, and **ESCAPE**.

1. While in User Mode, press AIR to scroll to **CAL SET**.

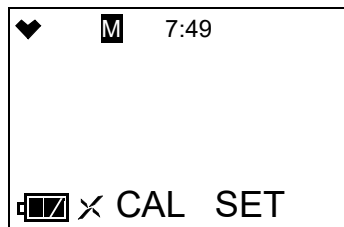

2. Press POWER MODE. The **CAL.RMDR** menu item appears.

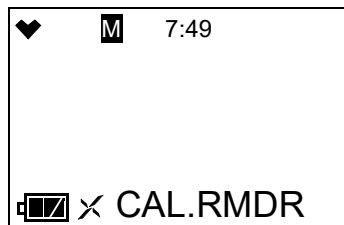

CAL.RMDR

ON (factory setting): The GX-Force gives an indication at start up if it is due for calibration. The type of indication depends on the **CAL.EXPD** setting (see page 82).

OFF: The GX-Force does not give an indication at start up if it is due for calibration.

1. After entering the CAL SET menu, press AIR to scroll to **CAL.RMDR**.

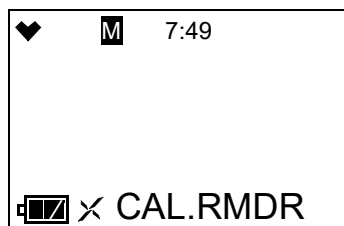

2. Press POWER MODE. The current setting flashes.

3. Use AIR to display the desired setting.
4. Press POWER MODE to save the setting and return to the **CAL.RMDR** menu item.
5. See “Exiting the CAL SET Menu” on page 83 to return to User Mode.

CAL.INT

This setting defines the amount of time between calibrations. The time can be set in 1 day increments. The minimum setting is **1** day and the maximum setting is **1000** days. The factory setting is **90** days.

1. After entering the CAL SET menu, press AIR to scroll to **CAL.INT**.

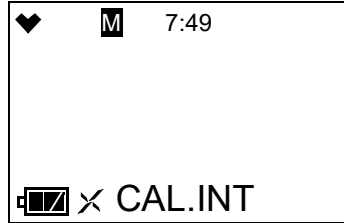

2. Press POWER MODE. The current setting flashes.
3. Use AIR to display the desired setting.
4. Press POWER MODE to save the setting and return to the **CAL.INT** menu item.
5. See “Exiting the CAL SET Menu” on page 83 to return to User Mode.

CAL.EXPD

This item defines what indication is given during start up when calibration is due and **CAL.RMDR** is set to **ON**.

CONFIRM (factory setting): The GX-Force gives an indication at start up if calibration is past due. Press AIR to continue without calibrating or press POWER MODE to perform a calibration.

CANT USE: The GX-Force gives an indication at start up if calibration is past due. Press POWER MODE to enter User Mode and perform a calibration. Pressing AIR has no effect. A successful calibration must be performed in order to use the instrument.

NONE: The GX-Force gives an indication at startup if calibration is past due. If desired, press POWER MODE to perform a calibration but it is not necessary to acknowledge the calibration due indication. The warm-up sequence will continue on its own.

1. After entering the **CAL SET** menu, press AIR to scroll to **CAL.EXPD**.

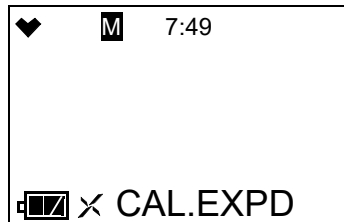

2. Press POWER MODE. The current setting flashes.

3. Use AIR to display the desired setting.
4. Press POWER MODE to save the setting and return to the **CAL.EXPD** menu item.
5. See “Exiting the CAL SET Menu” on page 83 to return to User Mode.

Exiting the CAL SET Menu

1. While in the **CAL SET** menu, press AIR to scroll to **ESCAPE**.
2. Press POWER MODE. The instrument returns to the **CAL SET** menu item in User Mode.
3. See “Entering Measuring Mode (START)” on page 97 to enter Measuring Mode.

Setting Bump Test Parameters (BUMP.SET)

The **BUMP.SET** menu item has 5 items: **SETTING**, **BMP.RMDR**, **BMP.INT**, **BMP.EXPD**, and **ESCAPE**.

1. While in User Mode, press AIR to scroll to **BUMP.SET**.



2. Press POWER MODE. The **SETTING** menu item appears.

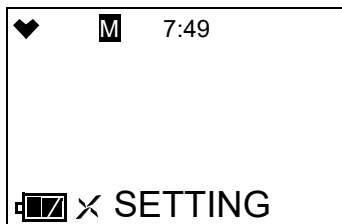

SETTING

The **SETTING** menu item has 5 items: **GAS.TIME**, **CHECK**, **CAL.TIME**, **AUTO.CAL**, and **ESCAPE**.

1. After entering the BUMP.SET menu, press AIR to scroll to **SETTING**.

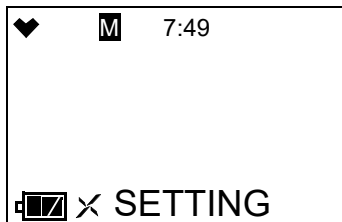

2. Press POWER MODE. The **GAS.TIME** menu item appears.

GAS.TIME

The **GAS.TIME** is the amount of time that the instrument is exposed to gas during a bump test. The available choices are **30** seconds (factory setting), **45** seconds, **60** seconds, and **90** seconds.

1. After entering the BUMP.SET\SETTING menu, press AIR to scroll to **GAS.TIME**.

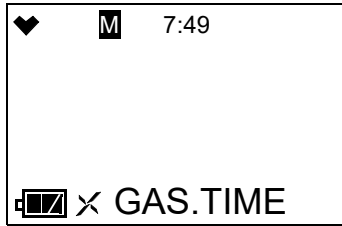

2. Press POWER MODE. The current setting flashes.
3. Use AIR to display the desired setting.
4. Press POWER MODE to save the setting and return to the **GAS.TIME** menu item.
5. See “Exiting the SETTING Menu” on page 85 to return to the **BUMP.SET** menu.
6. See “Exiting the BUMP.SET Menu” on page 87 to return to User Mode.

CHECK

CHECK is the bump test tolerance value and is represented as a percentage of the calibration gas concentration. It is the percentage that the bump test reading can differ from the actual gas concentration and still be considered a passed bump test. If the bump test reading differs more, the bump test will fail. The available values are **10%**, **20%**, **30%**, **40%**, and **50%** (factory setting).

1. After entering the BUMP.SET\SETTING menu, press AIR to scroll to **CHECK**.

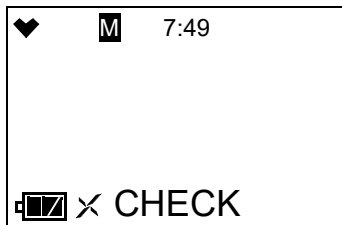

2. Press POWER MODE. The current setting flashes.
3. Use AIR to display the desired setting.
4. Press POWER MODE to save the setting and return to the **CHECK** menu item.
5. See “Exiting the SETTING Menu” on page 85 to return to the **BUMP.SET** menu.
6. See “Exiting the BUMP.SET Menu” on page 87 to return to User Mode.

CAL.TIME

The **CAL.TIME** is the total time the instrument is exposed to calibration gas when a bump test fails if **AUTO.CAL** is set to **ON**. The bump test time is deducted from the calibration time.

For example, if the **CAL.TIME** is set to 90 seconds and the **GAS.TIME** is set to 30 seconds, if the bump test fails, the GX-Force will only be exposed to gas for an additional 60 seconds. The available values are **90** seconds (factory setting), and **120** seconds.

1. After entering the BUMP.SET\SETTING menu, press AIR to scroll to **CAL.TIME**.

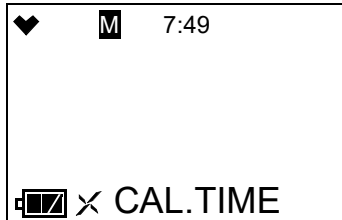

2. Press POWER MODE. The current setting flashes.
3. Use AIR to display the desired setting.
4. Press POWER MODE to save the setting and return to the **CAL.TIME** menu item.
5. See “Exiting the SETTING Menu” on page 85 to return to the **BUMP.SET** menu.
6. See “Exiting the BUMP.SET Menu” on page 87 to return to User Mode.

AUTO.CAL

ON (factory setting): If a bump test fails, the unit automatically begins a calibration.

OFF: If a bump test fails, the unit does not automatically begin a calibration.

1. After entering the BUMP.SET\SETTING menu, press AIR to scroll to **AUTO.CAL**.

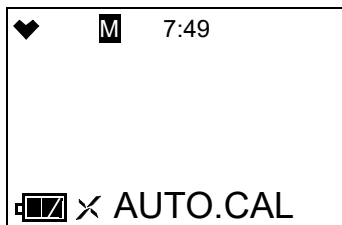

2. Press POWER MODE. The current setting flashes.
3. Use AIR to display the desired setting.
4. Press POWER MODE to save the setting and return to the **AUTO.CAL** menu item.
5. See “Exiting the SETTING Menu” on page 85 to return to the **BUMP.SET** menu.
6. See “Exiting the BUMP.SET Menu” on page 87 to return to User Mode.

Exiting the SETTING Menu

1. While in the BUMP.SET\SETTING menu, press AIR to scroll to **ESCAPE**.
2. Press POWER MODE. The instrument returns to the **SETTING** menu item of the BUMP.SET menu.

BMP.RMDR

ON: The GX-Force gives an indication at start up if it is due for bump testing. The type of indication depends on the **BMP.EXPD** setting (see page 87).

OFF (factory setting): The GX-Force does not give an indication at start up if it is due for bump testing.

1. After entering the BUMP.SET menu, press AIR to scroll to **BMP.RMDR**.

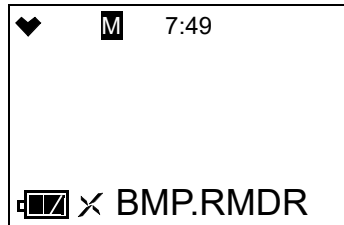

2. Press POWER MODE. The current setting flashes.
3. Use AIR to display the desired setting.
4. Press POWER MODE to save the setting and return to the **BMP.RMDR** menu item.
5. See “Exiting the BUMP.SET Menu” on page 87 to return to User Mode.

BMP.INT

This setting defines the amount of time between bump tests. The time can be set in 1 day increments. The minimum setting is **0** days and the maximum setting is **30** days (factory setting).

1. After entering the BUMP.SET menu, press AIR to scroll to **BMP.INT**.

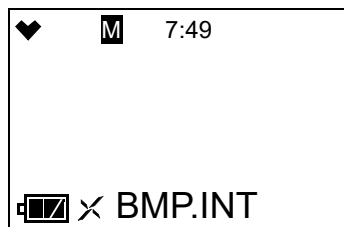

2. Press POWER MODE. The current setting flashes.
3. Use AIR to display the desired setting.
4. Press POWER MODE to save the setting and return to the **BMP.INT** menu item.
5. See “Exiting the BUMP.SET Menu” on page 87 to return to User Mode.

BMP.EXPD

This item defines what indication is given during start up when a bump test is due and **BMP.RMDR** is set to **ON**.

CONFIRM (factory setting): The GX-Force gives an indication at start up if a bump test is past due. Press AIR to continue without bump testing or press POWER MODE to perform a bump test.

CANT USE: The GX-Force gives an indication at start up if a bump test is past due. Press POWER MODE to enter User Mode and perform a bump test. Pressing AIR has no effect. A successful bump test must be performed in order to use the instrument.

NONE: The GX-Force gives an indication at startup if a bump test is past due. If desired, press POWER MODE to perform a bump test but it is not necessary to acknowledge the bump test due indication. The warm-up sequence will continue on its own.

1. After entering the BUMP.SET menu, press AIR to scroll to **BMP.EXPD**.

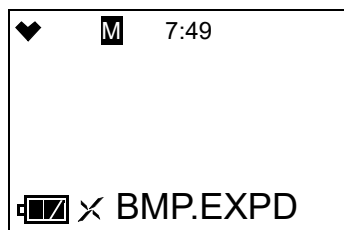

2. Press POWER MODE. The current setting flashes.
3. Use AIR to display the desired setting.
4. Press POWER MODE to save the setting and return to the **BMP.EXPD** menu item.
5. See “Exiting the BUMP.SET Menu” on page 87 to return to User Mode.

Exiting the BUMP.SET Menu

1. While in the BUMP.SET menu, press AIR to scroll to **ESCAPE**.
2. Press POWER MODE. The instrument returns to the **BUMP.SET** menu item in User Mode.
3. See “Entering Measuring Mode (START)” on page 97 to enter Measuring Mode.

Alarm Settings (ALARM--P)

The **ALARM--P** menu item has 3 items: **ALARM--P**, **DEF--ALMP**, and **ESCAPE**.

1. While in User Mode, press AIR to scroll to **ALARM--P**.

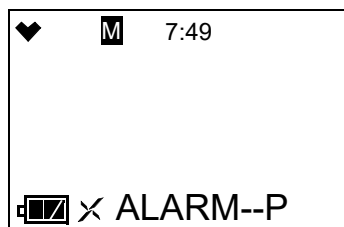

2. Press POWER MODE. The first channel displays.

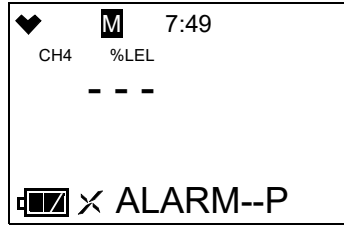

Setting the Alarm Points

1. After entering the Alarm Points menu item, press AIR to scroll through to the instrument channel whose alarm points you want to change.

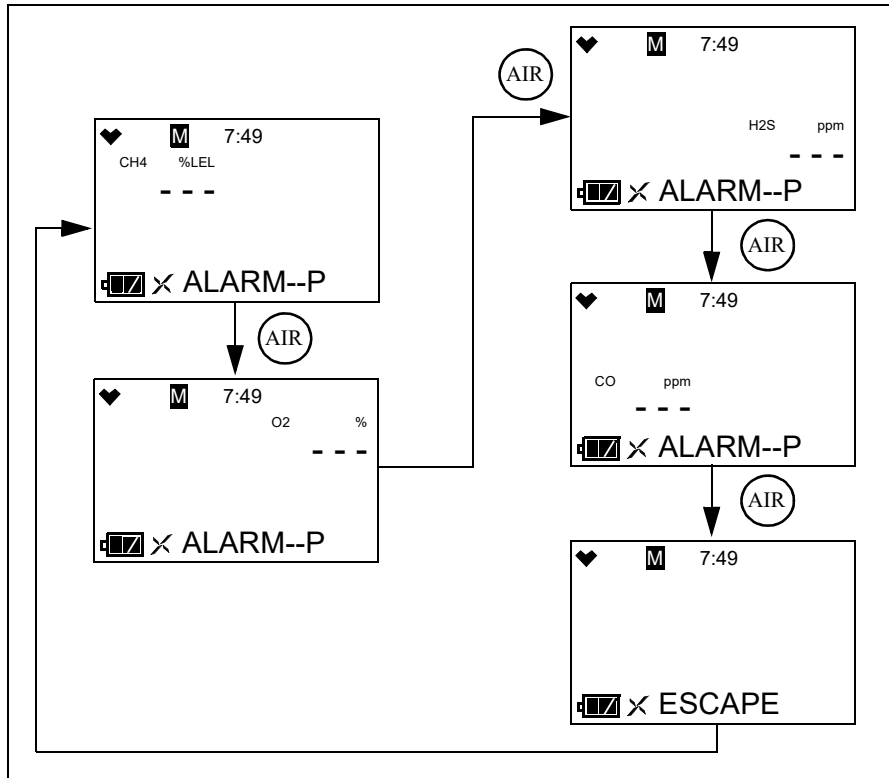

2. Press POWER MODE.

- The Warning setpoint for the channel flashes. In the example below, the CO channel is selected.

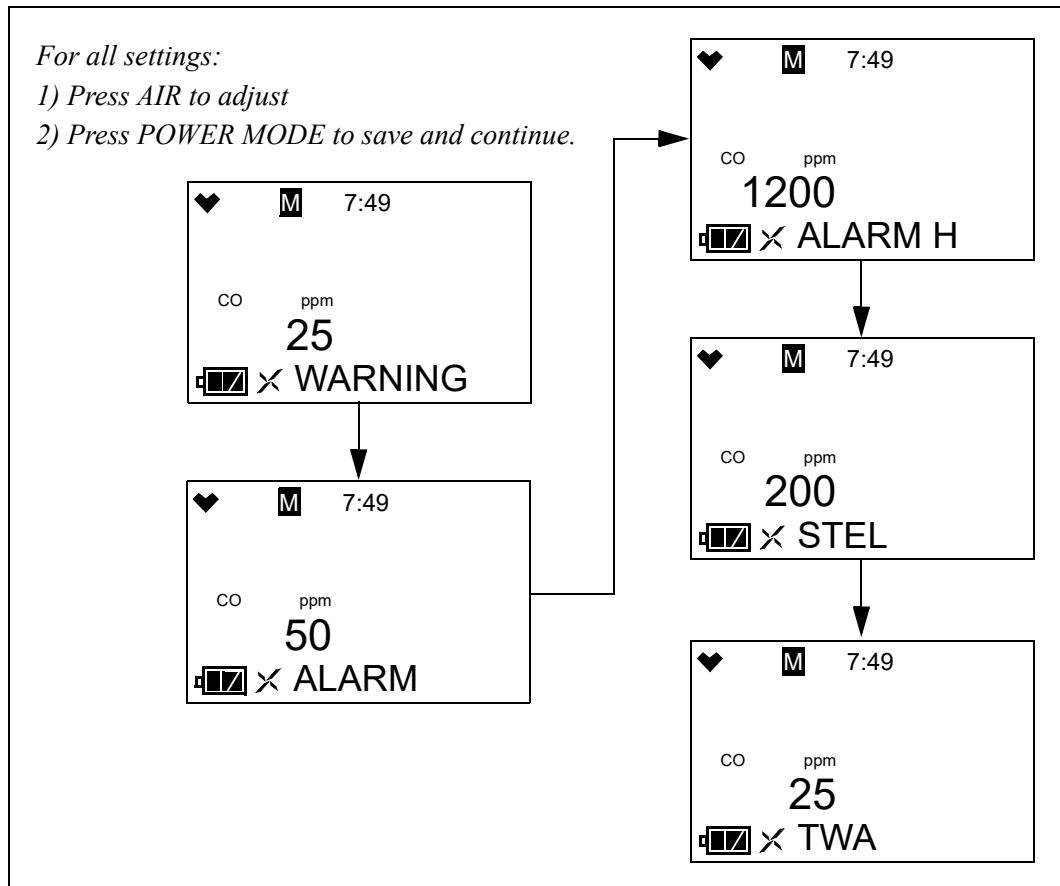

- Use AIR to adjust the Warning setpoint. Alarm setpoint limitations are shown below.

Channel	Alarm Point Limitations
Combustible Gas	1% LEL ≤ WARNING ≤ ALARM ≤ ALARM H ≤ 60% LEL
O ₂	<ul style="list-style-type: none"> • 0.0% ≤ ALARM ≤ WARNING ≤ 20.0% • 21.8% ≤ ALARM H ≤ 25.0%
H ₂ S	1.0 ppm ≤ WARNING ≤ ALARM ≤ ALARM H ≤ 200.0 ppm
CO	12 ppm ≤ WARNING ≤ ALARM ≤ ALARM H ≤ 2000 ppm

- Press POWER MODE to save the setting.
- Repeat Step 4 and Step 5 for the Alarm, Alarm H, STEL (CO and H₂S only), and TWA (CO and H₂S only) settings.
- The instrument returns to the channel selection screen.
- Repeat Step 1 - Step 7 to change the alarm points for other channels.
- See “ESCAPE” on page 90 to return to User Mode.

Defaulting the Alarm Points

Defaulting the alarm points defaults them back to factory settings as outlined in Table 1 on page 10 or to the settings saved in the **SAVE-AP** menu item in Gas Select Mode if you have performed a **SAVE-AP** operation.

1. After entering the Alarm Points menu item, press AIR to scroll to **DEF.ALMP**.



2. Press POWER MODE to enter the **DEF.ALMP** menu item.
3. Press POWER MODE to perform an alarm default. Press AIR to return to the **DEF.ALMP** menu item.
4. The instrument asks if you're sure you want to default the alarm points. Press POWER MODE to default the alarm points. Press AIR to return to the **DEF.ALMP** menu item.
5. See "ESCAPE" on page 90 to return to User Mode.

ESCAPE

1. While in the ALARM--P menu, press AIR to scroll to **ESCAPE**.
2. Press POWER MODE. The instrument returns to the **ALARM--P** menu item.
3. See "Entering Measuring Mode (START)" on page 97 to enter Measuring Mode.

Updating the Lunch Break Setting (LUNCH)

OFF (factory setting): The GX-Force automatically starts new TWA and PEAK reading collection and resets the time in operation at startup.

ON: The Lunch Break Screen displays during startup. From this screen, you can choose to continue accumulating TWA and PEAK readings and the time in operation from the last time the GX-Force was used or start collecting new readings and reset the time in operation.

1. While in User Mode, press AIR to scroll to **LUNCH**.

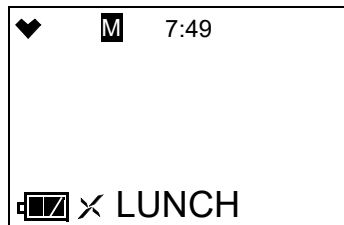

2. Press POWER MODE. The current setting flashes.
3. Use AIR to display the desired setting.

4. Press POWER MODE to save the setting and return to the **LUNCH** menu item.
5. See “Entering Measuring Mode (START)” on page 97 to enter Measuring Mode.

Setting the Confirmation Beep and Non-Compliance Indicator (BEEP)

The **BEEP** menu item has 3 items: **BEEP.SEL**, **BEEP.INT**, and **ESCAPE**.

1. While in User Mode, press AIR to scroll to **BEEP**.

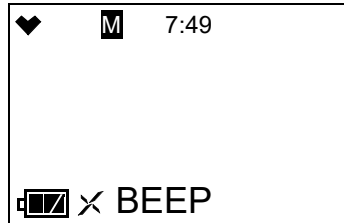

2. Press POWER MODE. The **BEEP.SEL** menu item appears.

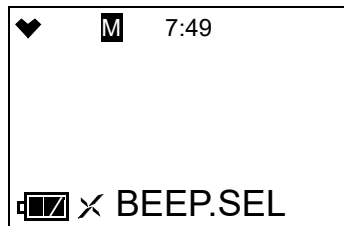

BEEP.SEL

BEEP.SEL defines what kind of confirmation or non-compliance indication you want to occur in Measuring Mode. The available choices are:

- **OFF** (factory setting): The GX-Force does not provide a confirmation alert or non-compliance indicator.
- **LED**: The GX-Force’s LEDs double flash as often as defined by the **BEEP.INT** parameter to verify that the instrument is operating.
- **BUZZER**: The GX-Force’s buzzer double beeps as often as defined by the **BEEP.INT** parameter to verify that the instrument is operating.
- **LED+BUZZ**: The GX-Force’s LEDs double flash and the buzzer double beeps as often as defined by the **BEEP.INT** parameter to verify that the instrument is operating.
- **BUMP/CAL**: If a bump test or a calibration is due and if **BMP.EXPD** or **CAL.EXPD** is set to **CONFIRM** or **NONE**, the GX-Force’s LEDs double flash as often as defined by the **BEEP.INT** parameter to indicate a non-compliance. Once a bump test or calibration (depending on which is due) is done, the LEDs stop flashing.
- **ALM ALRT**: If the instrument goes into any gas alarm, the LEDs double flash as often as defined by the **BEEP.INT** parameter to indicate a non-compliance. Once a successful bump test or calibration is done, the LEDs stop flashing.

- **B/C/ALM**: The LEDs double flash to indicate a non-compliance if any of the following are true:
 - **BMP.EXPD** is set to **CONFIRM** or **NONE** and a bump test is due (cleared by successful bump test).
 - **CAL.EXPD** is set to **CONFIRM** or **NONE** and a calibration is due (cleared by successful calibration).
 - The instrument goes into any gas alarm (cleared by successful bump test or calibration).

1. While in the **BEEP** menu, press AIR to scroll to **BEEP.SEL**.

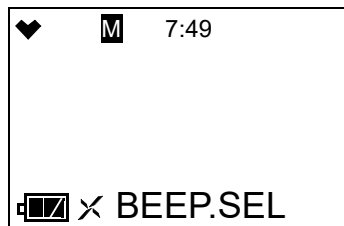

2. Press POWER MODE. The current setting flashes.
3. Use AIR to display the desired setting.
4. Press POWER MODE to save the setting and return to the **BEEP.SEL** menu item.
5. See “ESCAPE” on page 93 to return to User Mode.

BEEP.INT

The **BEEP.INT** parameter defines how often the confirmation alert or non-compliance indicator selected in **BEEP.SEL** occurs. This setting only applies if the **BEEP.SEL** parameter is set to something other than **OFF**. The available choices are **0.5** minutes and **1-99** minutes in 1 minute increments. The factory setting is **5** minutes.

1. While in the **BEEP** menu, press AIR to scroll to **BEEP.INT**.

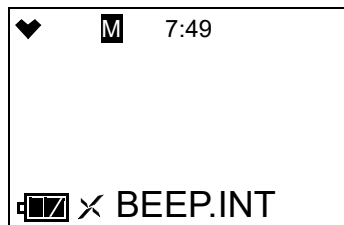

2. Press POWER MODE. The current setting flashes.
3. Use AIR to display the desired setting.
4. Press POWER MODE to save the setting and return to the **BEEP.INT** menu item.
5. See “ESCAPE” on page 93 to return to User Mode.

ESCAPE

1. While in the **BEEP** menu, press AIR to scroll to **ESCAPE**.
2. Press POWER MODE. The instrument return to the **BEEP** menu item.
3. See “Entering Measuring Mode (START)” on page 97 to enter Measuring Mode.

Updating the Backlight Time (BL TIME)

This setting defines how long the LCD backlight stays on when you press any button. The minimum setting is **OFF**; the maximum setting is **255** seconds. The factory setting is **30** seconds.

1. While in User Mode, press AIR to scroll to **BL TIME**.

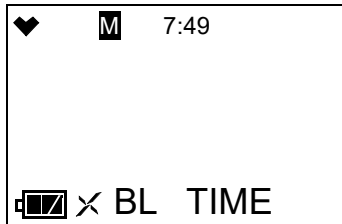

2. Press POWER MODE. The current setting flashes.
3. Use AIR to display the desired setting.
4. Press POWER MODE to save the setting and return to the **BL TIME** menu item.
5. See “Entering Measuring Mode (START)” on page 97 to enter Measuring Mode.

Turning the Key Tone On/Off (KEY.TONE)

ON (factory setting): The instrument beeps when a button is pressed.

OFF: The instrument does not beep when a button is pressed.

1. While in User Mode, press AIR to scroll to **KEY.TONE**.

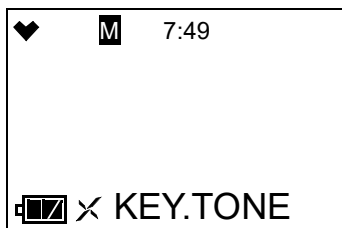

2. Press POWER MODE. The current setting flashes.
3. Use AIR to display the desired setting.
4. Press POWER MODE to save the setting and return to the **KEY.TONE** menu item.
5. See “Entering Measuring Mode (START)” on page 97 to enter Measuring Mode.

Display Mode Items (DISP.SET)

OFF: LIST, USER ID, STN ID, and PUMP.OFF items do not appear in Display Mode.

ON (factory setting): LIST item appears in Display Mode. USER ID and STN ID screens appear in Display Mode if ID DISP in Maintenance Mode is also set to ON (factory setting is OFF).

PUMP.OFF appears in Display Mode if POFF.DSP is also set to ON (factory setting is OFF).

1. While in User Mode, press AIR to scroll to **DISP.SET**.



2. Press POWER MODE. The current setting flashes.
3. Use AIR to display the desired setting.
4. Press POWER MODE to save the setting and return to the **DISP.SET** menu item.
5. See “Entering Measuring Mode (START)” on page 97 to enter Measuring Mode.

Zero Suppression (ZERO.SUP)

This menu item only appears if ZSUP.DISP is set to ON in Maintenance Mode (factory setting is OFF).

The ZERO.SUP setting is not intended for field adjustment. The default setting for each sensor is ON.

Sensor	Zero Suppression Value
Combustible Gas	2% LEL
O ₂	0.5% volume
H ₂ S	0.3 ppm
CO	2 ppm

Zero Follower (ZERO.FLW)

This menu item only appears if ZFLW.DISP is set to ON in Maintenance Mode (factory setting is OFF).

The ZERO.FLW setting is not intended for field adjustment. The default setting is ON. The oxygen channel does not support zero follower functionality.

Setting the Date/Time (DATE)

1. While in User Mode, press AIR to scroll to **DATE**.

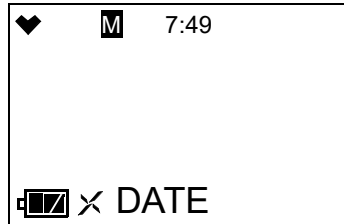

2. Press POWER MODE. The date and time display with the year flashing.

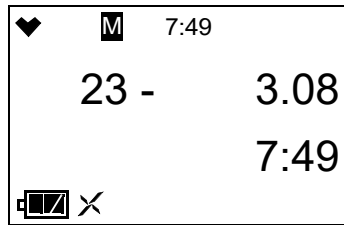

3. Use AIR to display the desired year.
4. Press POWER MODE to save the setting. The month setting flashes.
5. Repeat Step 3 and Step 4 to enter the month, day, hours, and minutes settings. The date and time are saved and the instrument returns to the **DATE** menu item.
6. See “Entering Measuring Mode (START)” on page 97 to enter Measuring Mode.

Turning the Password On/Off (PASS - - W)

ON: The GX-Force prompts you for a password when you enter User Mode. The factory-set password is **0000** but it can be changed as desired.

OFF (factory setting): No password is required to enter User Mode.

1. While in User Mode, press AIR to scroll to **PASS - - W**.

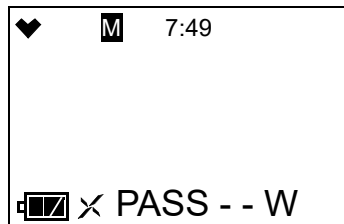

2. Press POWER MODE. The current setting flashes.
3. Use AIR to display the desired setting.
4. If you selected **OFF**, press POWER MODE to save the setting and return to the **PASS - - W** item in User Mode.
If you selected **ON**, continue with Step 5.

5. Press POWER MODE. The Set Password Screen appears. The current password appears and the first digit flashes.

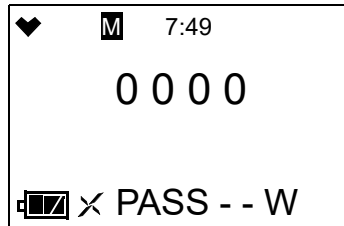

6. Use AIR to display a number from 0 to 9.
7. Press POWER MODE to enter the selection and advance to the next number. To go back a number, press and hold AIR and POWER MODE for a few seconds.
8. Repeat Step 6 and Step 7 to select the remaining numbers. When you press POWER MODE to enter the last number, the password is saved and you return to the **PASS--W** item in User Mode.
9. See “Entering Measuring Mode (START)” on page 97 to enter Measuring Mode.

Viewing the ROM/SUM (ROM/SUM)

The **ROM/SUM** screen shows the instrument and sensor ROM/SUM numbers.

1. While in User Mode, press AIR to scroll to **ROM/SUM**.

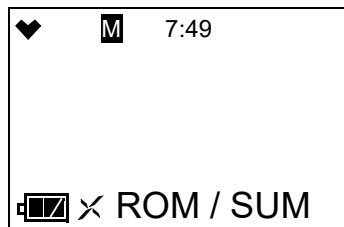

2. Press POWER MODE. The screen cycles through the main board’s ROM/SUM and the sensor board’s ROM/SUM. The ROM is the top value and the SUM is the bottom value.

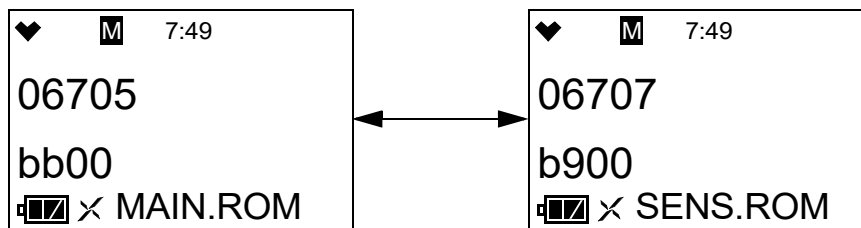

3. Press POWER MODE to return to the **ROM/SUM** menu item in User Mode.
4. See “Entering Measuring Mode (START)” on page 97 to enter Measuring Mode.

Entering Measuring Mode (START)

1. While in User Mode, press AIR to scroll to **START**.

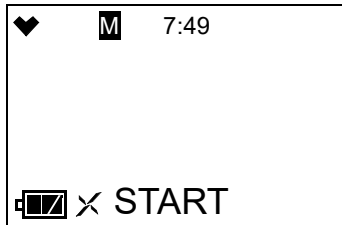

2. Press POWER MODE. The instrument begins its warmup sequence.

Chapter 6: Maintenance

Overview

This chapter describes troubleshooting procedures for the GX-Force. It also includes procedures for instrument cleaning, recharging the batteries, and replacing various consumable parts.

WARNING: *RKI Instruments, Inc. recommends that service, calibration, and repair of RKI instruments be performed by personnel properly trained for this work. Replacing sensors and other parts with original equipment does not affect the intrinsic safety of the instrument.*

Troubleshooting

Table 15 describes error messages, symptoms, probable causes, and recommended action for problems you may encounter with the GX-Force.

Table 15: Troubleshooting the GX-Force

Symptoms	Probable Causes	Recommended Action
<ul style="list-style-type: none">The LCD is blank.	<ul style="list-style-type: none">The unit may have been turned off.The battery pack may need to be recharged.	<ol style="list-style-type: none">To turn on the unit, press and briefly hold POWER MODE.If the unit does not turn on, recharge the battery pack.If the difficulties continue, contact RKI Instruments, Inc. for further instruction.
<ul style="list-style-type: none">The LCD shows abnormally high or low readings but other gas detection instruments do not.	<ul style="list-style-type: none">The filters may need to be replaced.The GX-Force may need to be recalibrated.The sensor for the affected channel(s) may need replacement.	<ol style="list-style-type: none">Replace the filters.Recalibrate the unit.If the difficulties continue, replace the sensor for the affected channel(s) and calibrate the affected channel(s).If the difficulties continue, contact RKI Instruments, Inc. for further instruction.
<ul style="list-style-type: none">Calibration fails.	<ul style="list-style-type: none">The calibration values may not match the cylinder gas concentrations.The charcoal filter or charcoal half of the dual filter is saturated causing an elevated CO reading.The sample gas is not reaching the sensors because of a bad connection.The calibration cylinder may be out of gas or is outdated.The sensor for the affected channel(s) may need replacement.	<ol style="list-style-type: none">Make sure the GX-Force has been properly set up for calibration.Change the charcoal filter or the dual filter.Check all calibration tubing for leaks or for any bad connections.Verify that the calibration cylinder contains an adequate supply of fresh test sample.If the fail condition continues, replace the sensor(s).If the difficulties continue, contact RKI Instruments, Inc. for further instruction.

Table 15: Troubleshooting the GX-Force

Symptoms	Probable Causes	Recommended Action
<ul style="list-style-type: none">Heart symbol at the top of the screen becomes steadily on or disappears	<ul style="list-style-type: none">A microprocessor error has occurred.	<ul style="list-style-type: none">Contact RKI Instruments, Inc. for further instruction.
<ul style="list-style-type: none">Charge LED alternates between green and orange	<ul style="list-style-type: none">Charging environment is outside the allowed 10°C - 40°C charging temperature range.	<ul style="list-style-type: none">Move the charger to a location that is within the allowed 10°C - 40°C charging temperature range.

Instrument Cleaning

Clean the GX-Force with a cloth dampened with water if it becomes excessively dirty. Do not use alcohol or other cleaning solvents.

Recharging the Lithium Ion Battery Pack

CAUTION: *To be used only with lithium ion battery pack p/n 49-1633. Charge only with RKI charger 49-0139 or 49-2022. Use of other rechargeable batteries or chargers or charging of other rechargeable batteries in the GX-Force will void the warranty.*

PRUDENCE: *À utiliser uniquement avec la batterie lithium-ion 49-1633. Charger uniquement avec le chargeur RKI 49-0139 ou 49-2022. L'utilisation d'autres batteries rechargeables ou chargeurs ou la charge d'autres batteries rechargeables dans le GX-Force annulera la garantie.*

1. Make sure the GX-Force is off.
2. Plug the AC adapter into an electrical outlet.
3. Pry off the protective insert covering the USB Type-C port on the bottom of the instrument.
4. Insert the USB Type-C adapter cable into the charging port. When the charger cable has been securely connected, the charging LED will light up green. The LED changes to orange as charging begins.
5. When the instrument is fully charged (after approximately 8 hours) the orange LED will turn green until it is disconnected from power. Detach the AC adapter cable from the GX-Force and unplug the AC power adapter from the AC outlet.

Replacing the Sensor Filters

Combustible Gas Sensor Filter

The H₂S filter disk is dark red in color and although it may darken over time, its color is not indicative of remaining filter life. The H₂S filter disk can absorb H₂S for 33 ppm hours and should be replaced after that much exposure. With this many ppm hours of absorption, the H₂S filter disk should be replaced after 80 minutes of exposure to 25 ppm H₂S. This equates to replacing the H₂S filter disk after 40 2-minute calibrations with a cylinder containing 25 ppm H₂S. If H₂S exists in the monitoring environment, the H₂S filter disk will have to be replaced more frequently.

Dual CO/H₂S Sensor Filter

The dual CO/H₂S sensor has a half black/half white filter installed over it. The filter should be replaced if you notice either 1) unexplained CO readings or 2) For users with a 1 ppm H₂S alarm setpoint: a drift on the H₂S channel's zero reading, unexplained H₂S readings, the filter appears dirty, or every 6 months (whichever is sooner).

CO-Only and H₂-Compensated CO Sensor Filter

A black charcoal filter is installed over CO-only and H₂-compensated CO sensors. The filter should be replaced if you notice unexplained CO readings.

H₂S-Only Sensor Filter

A white humidity filter is installed over H₂S-only sensors. The filter absorbs humidity in the sampling environment to prevent unstable readings around 0 ppm H₂S. For users with a 1 ppm H₂S alarm setpoint, the filter should be replaced if you notice: a drift on the H₂S channel's zero reading, unexplained H₂S readings, the filter appears dirty, or every 6 months (whichever is sooner). For users with a 2 ppm or higher H₂S alarm setpoint, the filter does not necessarily ever need to be replaced.

Replacement Procedure

1. Verify that the GX-Force is off.

2. Turn the GX-Force over so that the LCD is facing down. Use a small Phillips screwdriver to unscrew the four screws holding the back case to the front case of the GX-Force.

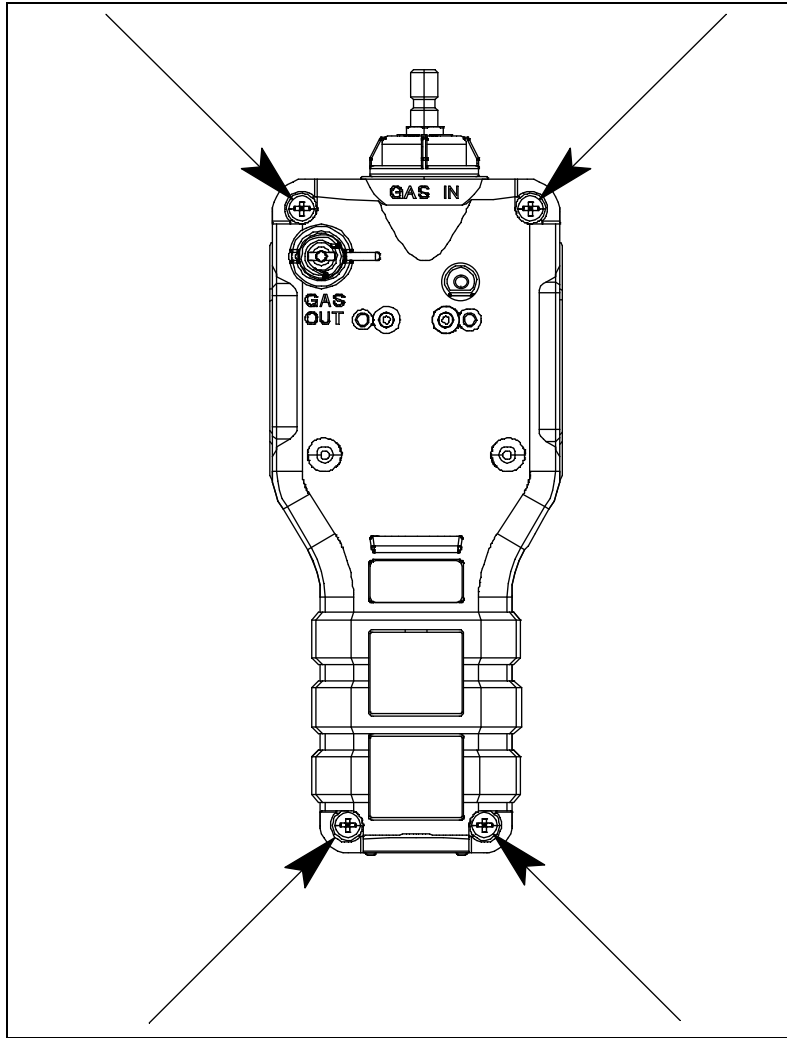

3. With the front of the GX-Force facing down, gently pry apart the front and back portions of the case.
4. Remove the filter gasket.
5. Gently pry out the filter you want to replace.

6. Install the new filters.
 - a. Dark red H₂S scrubber disk for combustible gas sensor: The brown side of the filter case should face toward the GX-Force.
 - b. Black and white combo filter for CO/H₂S dual sensor: The red side of the filter case should face toward the GX-Force. The black filter material should face the edge of the GX-Force while the white filter material should face the H₂S scrubber disk.
 - c. Black filter for CO-only sensor: The red side of the filter case should face toward the GX-Force.
 - d. White filter for H₂S-only sensor: The white side of the filter case should face toward the GX-Force.

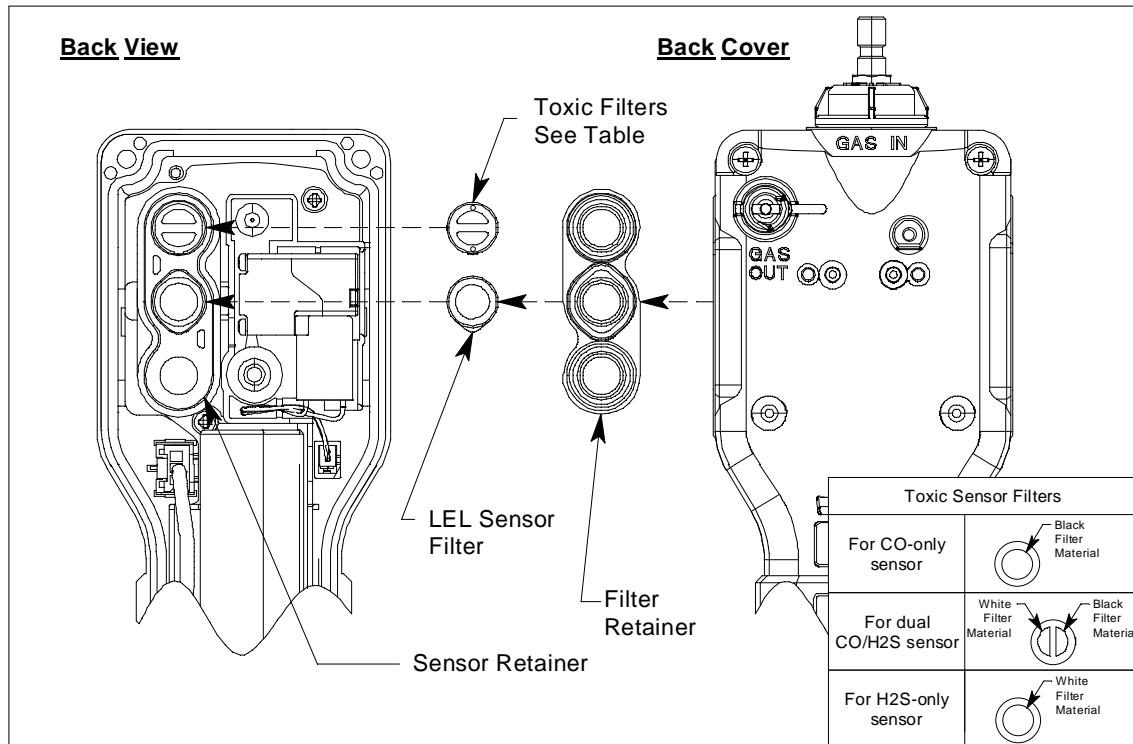

Figure 8: Replacing the Sensor Filters

7. Reinstall the filter gasket onto the sensor retainer. The gasket tabs face down.
8. Reattach the back cover to the GX-Force.
9. Reinstall the four screws that were loosened in Step 2.
10. Perform a bump test as described on page 63 to confirm good operation.

Replacing the Hydrophobic Filter and Wire Mesh Disk

1. Verify that the GX-Force is off.
2. Locate the clear plastic filter holder at the top of the GX-Force.

3. Grasp the filter holder and turn it 1/4 turn counterclockwise.
4. Pull the filter holder away from the case.
5. The wire mesh disk and hydrophobic filter are located in the case and are retained by a rubber gasket.

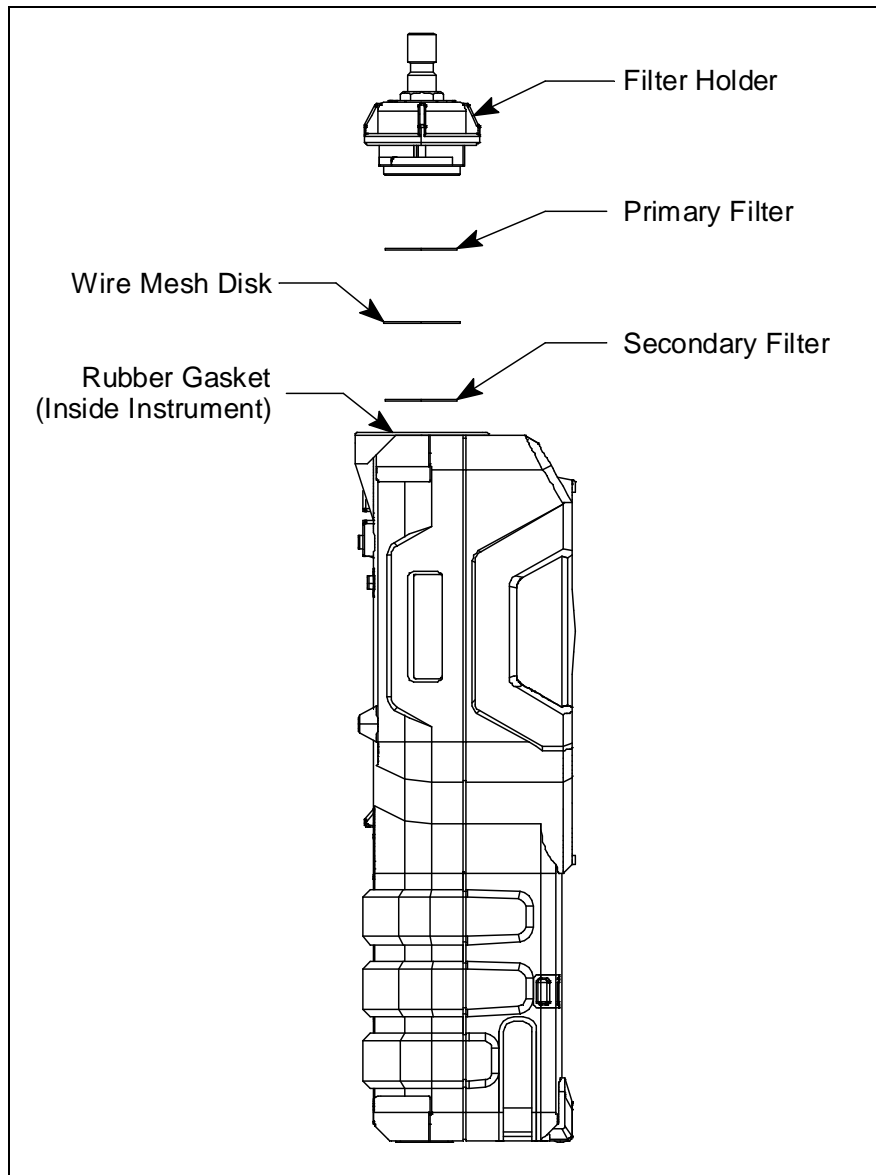

Figure 9: Changing the Filters & Wire Mesh Disk

6. Using a small flat head screwdriver, carefully pry the wire mesh disk and hydrophobic filter from the gasket. Do not remove the gasket.
7. Carefully install the new hydrophobic filter and/or wire mesh disk making sure the wire mesh disk is on top of the hydrophobic filter.
8. Reinstall the filter holder. Align the two wide tabs on the bottom of the filter holder with the two wide slots in the case where the filter holder fits. Push the filter holder into the case and turn it 1/4 turn clockwise until it snaps into place.

Replacing the Probe's Particle Filter and Hydrophobic Filter Disk

Inspect the probe's internal components if you notice that the GX-Force's pump sounds bogged down or if an unexplained low flow alarm occurs. Replace the particle filter and hydrophobic filter disk if they appear dirty or saturated with liquid. Replace the gasket in the probe if it appears damaged.

1. Hold the sample hose and probe assembly so that the probe tip is pointing up.
2. Grasp each end of the clear probe body firmly and unscrew the two halves from each other. The top half includes the probe tube.

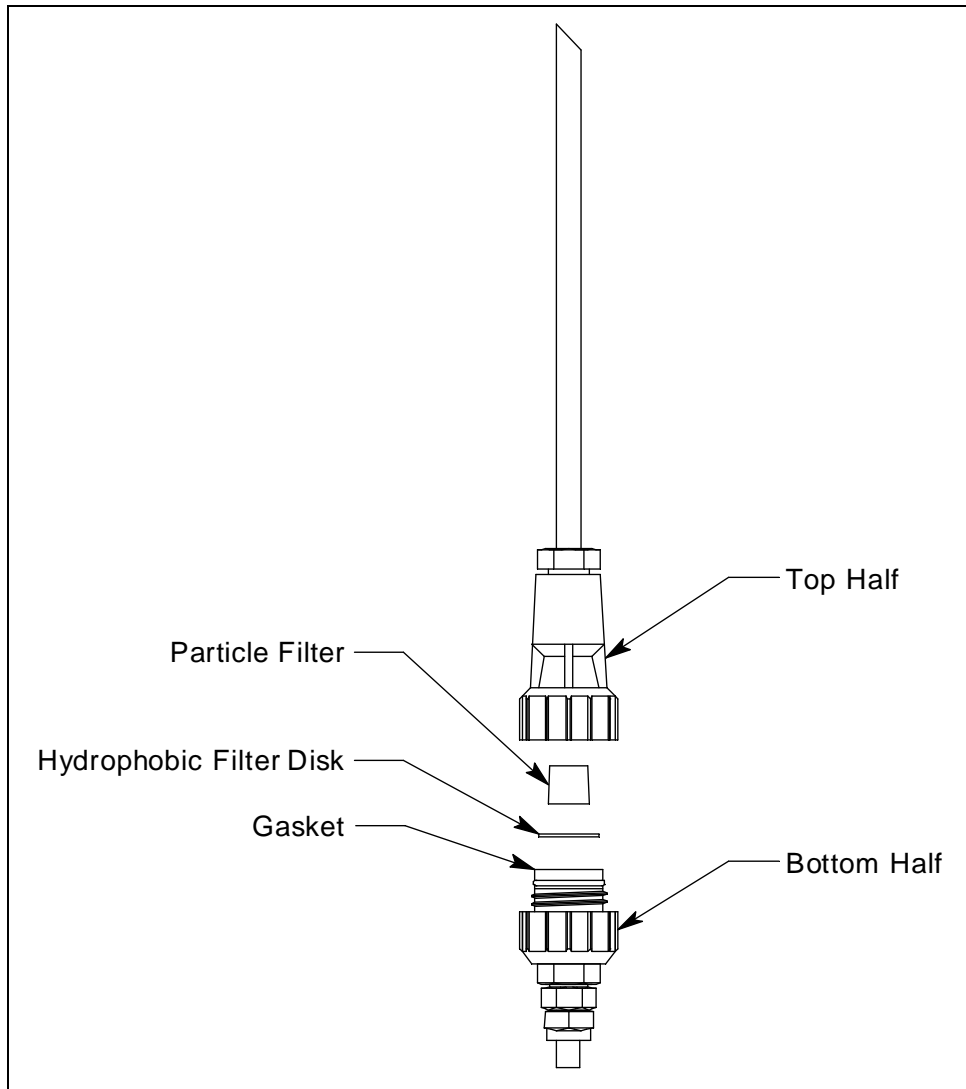

Figure 10: Replacing the Particle Filter and Hydrophobic Filter Disk

3. Set the top half aside.

4. The particle filter should be sitting on top of the hydrophobic filter disk. If it is not, remove it from the top half of the probe.
5. Remove the white hydrophobic filter disk from the top of the bottom half. The disk sits in a black gasket.
6. Place the new filter disk flat on top of the gasket. Make sure that it sits in the gasket and does not extend over the gasket's edge.
7. Set the new particle filter on top of the filter disk. The bigger end should be facing down.
8. Carefully screw the top half onto the bottom half disk while keeping the probe oriented with the probe tip facing up. The particle filter fits into a recess in the top half of the probe. Be sure the particle filter is not compressed in any way.
9. Tighten the halves together very firmly to ensure a seal.
10. To test the seal, do the following:
 - a. Install the probe on the GX-Force.
 - b. Startup the GX-Force.
 - c. Confirm that a low flow alarm occurs when you cover the end of the probe tube with your finger.
 - d. If a low flow alarm does not occur, hand tighten the probe further.
 - e. If a low flow alarm still does not occur when you cover the probe tube with your finger, disassemble the probe, inspect the placement of the hydrophobic filter disk, reassemble the probe, and re-test it.

Replacing a Sensor

CAUTION: *The CO, H₂S, and O₂ sensors contain an electrolyte solution. If contact with the electrolyte occurs, wash the area immediately.*

1. Verify that the GX-Force is off.
2. Turn the GX-Force over so that the LCD is facing down.
3. Use a small Phillips screwdriver to unscrew the four screws on the back cover of the GX-Force's case.
4. Gently pry apart the back case from the front.
5. Remove the filter gasket/sensor retainer assembly from the GX-Force. The sensors will be exposed.
6. Locate the sensor you want to replace and remove it from its socket.

- Carefully insert the replacement sensor in the correct socket. Be sure that the new sensor is installed in the same position as the old sensor and that it is aligned correctly. The toxic and oxygen sensors have slots to orient the sensor. The combustible gas sensor has tabs to orient the sensor. Do not force a sensor into its slot. If your instrument has a factory-installed dummy

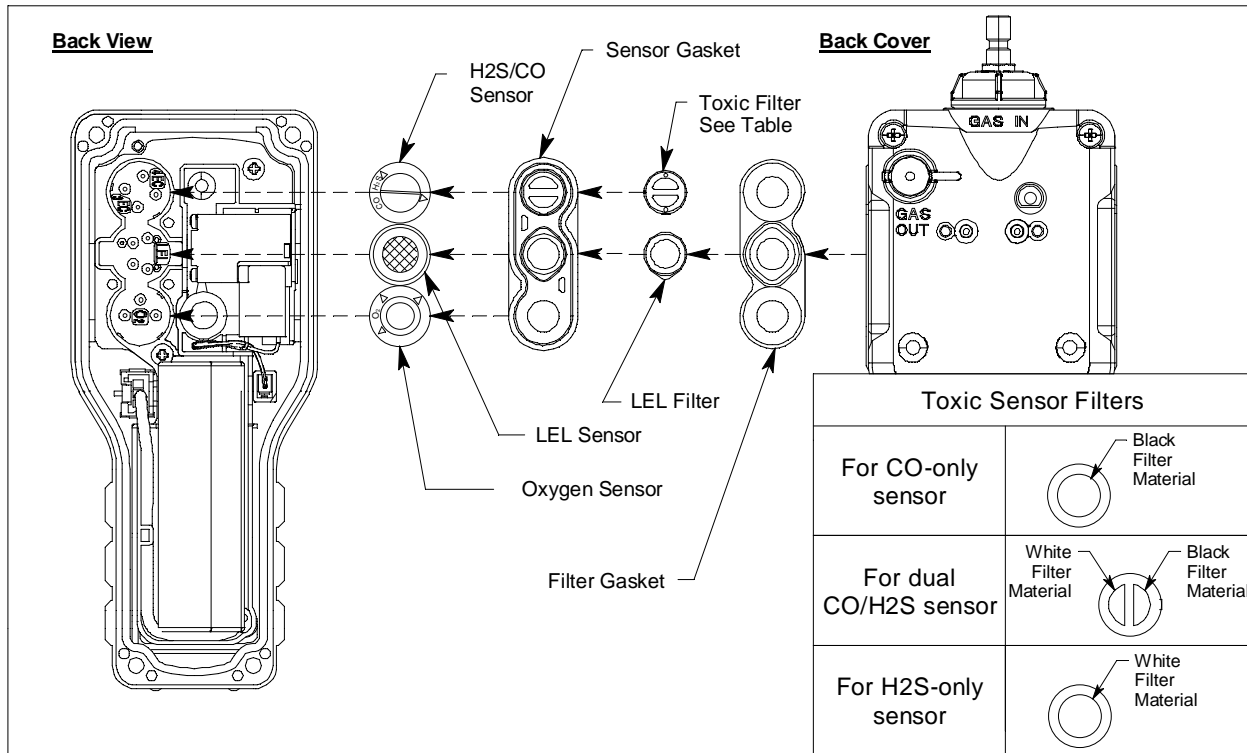

Figure 11: Replacing a Sensor

- sensor, ensure that it is still installed correctly. Make sure that the flat side is facing away from the GX-Force.
- Reinstall the filter gasket/sensor retainer assembly. The black and white filter goes over the CO/H₂S sensor with the black half of the filter facing the edge of the GX-Force. Be sure the filter gasket/sensor retainer is oriented correctly.
 - If the filter gasket came out, reinstall it with the gasket tabs facing down.
 - Reattach the back half of the case to the front case.
 - Tighten the four screws that were loosened in Step 3.
 - Calibrate the new sensors as described on page 70. If a new H₂-compensated CO sensor was installed, you need to calibrate with CO and set the H₂ response.

Chapter 7: Storage and Disposal

Storage

- Store away from direct sunlight
- Store in a location with normal temperature and humidity
- Store in a location free of gases, solvents, and vapors
- Store away from dust and dirt
- Discharge the battery to 1 bar in the battery icon to help prolong battery life and prevent battery deterioration.
- The GX-Force draws a small amount of power even while it is shut off. A GX-Force with a full battery can be stored for 3 years without losing power. A GX-Force with a battery in low battery alarm can be stored for about 3 months without losing power. If a GX-Force completely loses power during storage, the date/time must be reset as described on page 95.
- For long-term storage, the instrument should be turned on every 6 months to let the pump run for at least 3 minutes to prevent the pump's motor grease from solidifying.

Disposal

- Remove the battery pack
- Dispose in accordance with local regulations

Chapter 8: General Parts List

Table 16: General Parts List

Part Number	Description
06-1248RK-03	Calibration kit tubing, 3 foot length
07-2005RK	Inlet fitting gasket
07-6064	Filter gasket
07-6065	Charger port cover
10-1133	Screw for back case
13-0112RK	Wrist strap
13-0130	Belt clip with 3 installation screws
17-1001RK	Tapered nozzle
21-1833RK	Cotton filter holder with fitting
21-1983	Sensor retainer
33-0159RK	Filter disks, Teflon
33-1112RK	Filter disks, metal mesh
33-7130	Charcoal filter/humidity filter disk (black and white), for dual CO/H ₂ S sensor, 5 pack
33-7131	H ₂ S scrubber disk (dark red), for combustible gas sensor, 5 pack
33-7132	Charcoal filter disk (black), for CO and H ₂ -compensated CO sensors, 5 pack
33-7133	Humidity filter (white), for H ₂ S sensor, 5 pack
47-5116	USB Type-A to USB Type-C cable (for data downloading)
49-0139	AC adapter
49-2022	DC adapter
65-7004	Dummy sensor
71-0626	<i>GX-Force Operator's Manual</i> (this document)
71-0627	<i>GX-Force Datalogging Management Program Operator's Manual</i>
80-0009RK-10	Sample hose, 5 foot hose is standard, available lengths for the GX-Force are 3, 5, 10, 15, 20, 25, 30, 35, 40, 45, 50, and 100 feet
80-0172	Probe, with hydrophobic filter and particle filter, no scrubber section
80-0404RK	Dilution fitting, 1:1

Table 16: General Parts List (Continued)

Part Number	Description
81-0000RK-51	Calibration cylinder, 200 ppm H ₂ in air, 34 liter steel
81-0090RK-01	Calibration cylinder, 3-gas (CH ₄ /O ₂ /CO), 34 liter steel
81-0090RK-03	Calibration cylinder, 3-gas (CH ₄ /O ₂ /CO), 103 liter
81-0154RK-02	Calibration cylinder, 4-gas (CH ₄ /O ₂ / H ₂ S/CO), 58 liter
81-0154RK-04	Calibration cylinder, 4-gas (CH ₄ /O ₂ / H ₂ S/CO), 34 liter aluminum
81-1054RK-H2S	Regulator, demand-flow type, for CO, H ₂ S, zero air, and combustible gases in 34-liter aluminum, 58-liter, and 103-liter calibration cylinders (cylinders with internal threads)
81-1055RK	Regulator, demand-flow type, for all gases in 17- and 34-liter steel cylinders (cylinders with external threads)
ESR-A13i-H2S	Hydrogen sulfide (H ₂ S) sensor
ESR-A13P-CO	Carbon monoxide (CO) sensor
ESR-A1CP-CO-H	Hydrogen-compensated carbon monoxide (CO) sensor
ESR-A1DP-COHS	Dual carbon monoxide (CO) and hydrogen sulfide (H ₂ S) sensor
ESR-X13P-OXY	Oxygen sensor
NCR-6309	Combustible gas sensor, catalytic

Appendix A: Maintenance Mode

Overview

This appendix describes the GX-Force in Maintenance Mode. The GX-Force is factory-set to suit most applications. Update settings in Maintenance Mode only if required for your specific application. Maintenance Mode items and their factory settings are listed in Table 17.

Table 17: Maintenance Mode Menu Items

Maintenance Mode Menu Item	Description	
GAS.CAL (page 114)	Perform an air adjust, perform a span adjustment, change the calibration values, set the cylinder group.	
	AIR.CAL	Perform a fresh air adjustment.
	AUTO.CAL	Perform a span adjustment, set the calibration gas concentration, and set the cylinder for each gas.
		AUTO.CAL CYL X
	START	Begin the warmup sequence and enter Measuring Mode.
	CAL --P	Set the calibration concentration for each gas.
	CYL SEL	Assign a cylinder (A-E) to each gas (all 4 gases set to Cylinder A is the default). For single cal operation, you would assign each gas its own cylinder.
	ESCAPE	Return to the AUTO.CAL menu item.
ESCAPE	Return to the GAS.CAL menu item.	
GAS.TEST (page 114)	Apply gas to test sensor response and observe alarm indications without an alarm event being recorded.	
SEN.DATE (page 115)	View the replacement date for each sensor and the battery and/or set the replacement date for each sensor or the battery to the current date.	
BUMP (page 116)	Perform a bump test.	
	BUMP CYL X	Perform a bump test on the gases selected for Cylinder X (A-E cylinders available)
	START	Begin the warmup sequence and enter Measuring Mode.
	ESCAPE	Return to the BUMP menu item.

Table 17: Maintenance Mode Menu Items

Maintenance Mode Menu Item	Description
LATCH (page 117)	<p>ON (factory setting): The GX-Force remains in alarm until the alarm condition passes <i>and</i> POWER MODE is pressed.</p> <p>OFF: The GX-Force automatically resets an alarm when the alarm condition passes.</p>
ALM.SLNC (page 117)	<p>ON: The GX-Force’s buzzer can be silenced during an alarm condition by pressing the POWER MODE or AIR buttons.</p> <p>OFF (factory setting): The GX-Force’s buzzer cannot be silenced during an alarm condition by pressing the POWER MODE or AIR buttons.</p>
D.ZERO (page 118)	<p>ON (factory setting): You can manually perform a fresh air adjust in Measuring Mode by pressing AIR.</p> <p>OFF: You cannot manually perform a fresh air adjust in Measuring Mode by pressing AIR.</p>
A.ZERO (page 118)	<p>ON: The GX-Force asks if you want to perform a fresh air adjustment at the end of the startup sequence.</p> <p>OFF (factory setting): The GX-Force does not ask if you want to perform a fresh air adjustment at the end of the startup sequence.</p>
ID DISP (page 119)	<p>ON: User ID and Station ID screens appear in startup sequence. IDs can be changed in Display Mode if DISP.SET in User Mode is also set to ON.</p> <p>OFF (factory setting): User ID and Station ID screens do not appear in startup sequence. IDs cannot be changed in Display Mode.</p>
ZERO.SUP (page 119)	<p>ON (factory setting): Not intended for field adjustment. The suppression values are:</p> <ul style="list-style-type: none"> • Combustible Gas: 2% LEL • O₂: 0.5% volume • H₂S: 0.3 ppm • CO: 2 ppm
ZERO.FLW (page 119)	<p>ON (factory setting): Not intended for field adjustment. Oxygen channel does not support zero follower functionality.</p>
ZSUP.DSP (page 120)	<p>ON (factory setting): Zero suppression menu item appears in User Mode.</p> <p>OFF: Zero suppression menu item does not appear in User Mode. (Zero suppression menu item is always available in Maintenance Mode)</p>
ZFLW.DSP (page 120)	<p>ON: Zero follower menu item appears in User Mode.</p> <p>OFF (factory setting): Zero follower menu item does not appear in User Mode. (Zero follower menu item is always available in Maintenance Mode)</p>
POFF.DSP (page 120)	<p>ON: The PUMP.OFF screen appears in Display Mode (DISP.SET must also be set to ON). The GX-Force is not a gas monitoring device while the pump is off.</p> <p>OFF (factory setting): The Pump Off screen does not appear in Display Mode.</p>

Table 17: Maintenance Mode Menu Items

Maintenance Mode Menu Item	Description
DATE (page 120)	Set the current date and time.
PASS - - W (page 121)	ON (factory setting): Maintenance Mode is password-protected. Factory-set password is 2202 . OFF : Maintenance Mode is not password-protected.
ROM/SUM (page 122)	View the instrument's firmware version and checksum.
FLOW.ADJ (page 122)	Not intended for field use. This menu item does not adjust the instrument's low flow setpoint.
M.DEF (page 122)	Set all parameters back to their factory settings.
START (page 123)	Press POWER MODE to begin the warmup sequence and enter Measuring Mode.

Tips for Using Maintenance Mode

- To scroll from one menu item to the next, press AIR. To reverse the scrolling direction:
 - a. Press and hold AIR.
 - b. Immediately press POWER/MODE and then release both buttons.
 - c. The scrolling direction returns to the original direction when you exit and reenter a menu.
- To skip an item when a question is asked, press AIR.
- To enter an item and to save any changes, press POWER MODE.
- To change a flashing parameter, press AIR. To reverse the direction of change (i.e. from increasing to decreasing or vice versa):
 - a. Press and hold AIR.
 - b. Immediately press POWER MODE and then release both buttons.
- To exit an entered menu item without saving a change, press and hold AIR and POWER MODE for a few seconds.

Entering Maintenance Mode

WARNING: *The GX-Force is not in operation as a gas detector while in Maintenance Mode.*

1. Take the GX-Force to a non-hazardous location and turn it off if it is on.
2. Press and hold AIR, then press and hold POWER MODE. You will hear a beep after one second. Continue to hold the buttons down.
3. When you hear a second beep, release the buttons.
4. The screen that appears depends on the **PASS - - W** setting in Maintenance Mode.
 - If **PASS - - W** is set to **OFF**, continue with Step 7.
 - If **PASS - - W** is set to **ON** (factory setting), continue with Step 5.

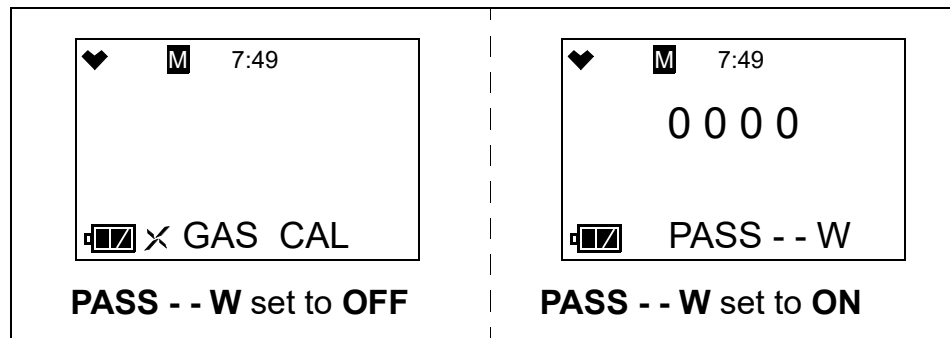

5. If **PASS - - W** is set to **ON** in Maintenance Mode, a password screen appears. The first digit flashes. The factory-set password is **2202**, but it can be changed as desired.
6. Use AIR to select each password number then press POWER MODE to save it and move on to the next number.
To go back a number, press and hold AIR and POWER MODE for a few seconds.
To reverse the direction of change (ie. from increasing to decreasing or vice versa):
 - a. Press and hold AIR.
 - b. Immediately press POWER MODE and then release both buttons.
7. The **GAS CAL** menu item displays.

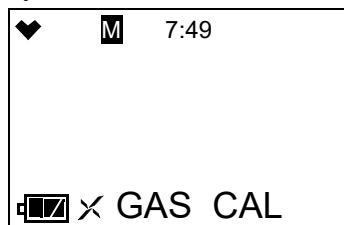

8. **M** at the top of the screen indicates that the GX-Force is in Maintenance Mode.
9. Use AIR to move through the Maintenance Mode menu items.

Performing a Calibration (GAS CAL)

See “Performing a Calibration (GAS CAL)” on page 70 for a description of the **GAS CAL** menu item.

Performing a Gas Test (GAS.TEST)

The **GAS.TEST** menu item allows you to apply gas to the instrument and see all alarm indications except for the buzzer indication. There is no buzzer indication in the **GAS.TEST** menu even though the buzzer will sound in the event of a real gas alarm condition while in Measuring Mode.

Materials

To perform a gas test on the GX-Force, you will need:

- A calibration cylinder
 - The concentrations should be above the alarm condition you want to check. Standard alarm points are listed on page 10.
- Demand flow regulator
- Non-absorbent tubing
- Sample hose and probe (if used during the monitoring session)

Performing a Gas Test

1. Install the demand flow regulator onto the calibration cylinder.
2. Connect the sample tubing to the demand flow regulator.
3. If used during normal operation, install the sample hose and probe onto the GX-Force inlet fitting.

Make sure the probe’s two halves are tightened firmly together to avoid leaks that can affect the calibration.

4. Make sure the GX-Force has been turned on for at least 45 seconds before continuing.
5. Connect the tubing from the demand flow regulator to either the GX-Force’s inlet fitting or the rigid tube on the probe (if in use) then quickly press POWER MODE to begin the countdown.
6. While in Maintenance Mode, press AIR to scroll to **GAS.TEST**.

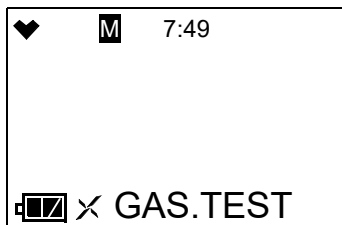

- Press POWER MODE. The current gas readings display. The bottom of the LCD alternates between “**GAS.TEST**” and “**BUZZ.OFF**”.

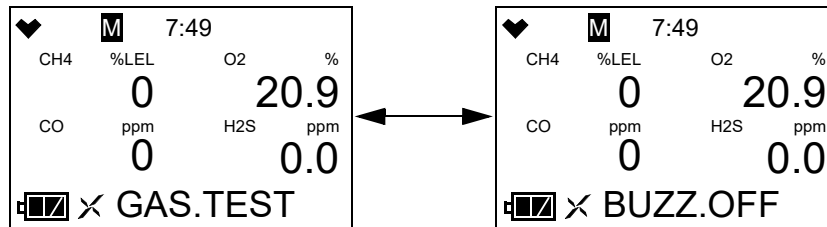

- The instrument initiates alarm indications except for the buzzer. There is no buzzer indication in the **GAS.TEST** menu even though the buzzer will sound in the event of a real gas alarm condition.
- Unscrew the regulator from the calibration cylinder.
- Disconnect the tubing from the gas inlet on the GX-Force.
- Store the calibration kit in a safe and convenient place.
- Press POWER MODE to return to the **GAS.TEST** menu item in Maintenance Mode.
- See “Entering Measuring Mode (START)” on page 123 to enter Measuring Mode.

Sensor/Battery Replacement Date (SEN.DATE)

The **SEN.DATE** menu item allows you to keep track of when the sensors and the battery were replaced.

- While in Maintenance Mode, press AIR to scroll to **SEN.DATE**.

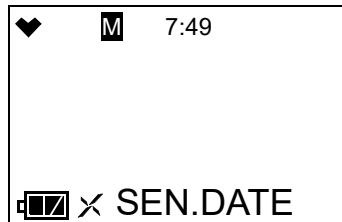

- Press POWER MODE. The combustible gas sensor’s replacement date displays.

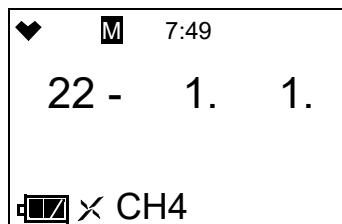

- Use AIR to scroll to the item whose replacement date you want to view or change.

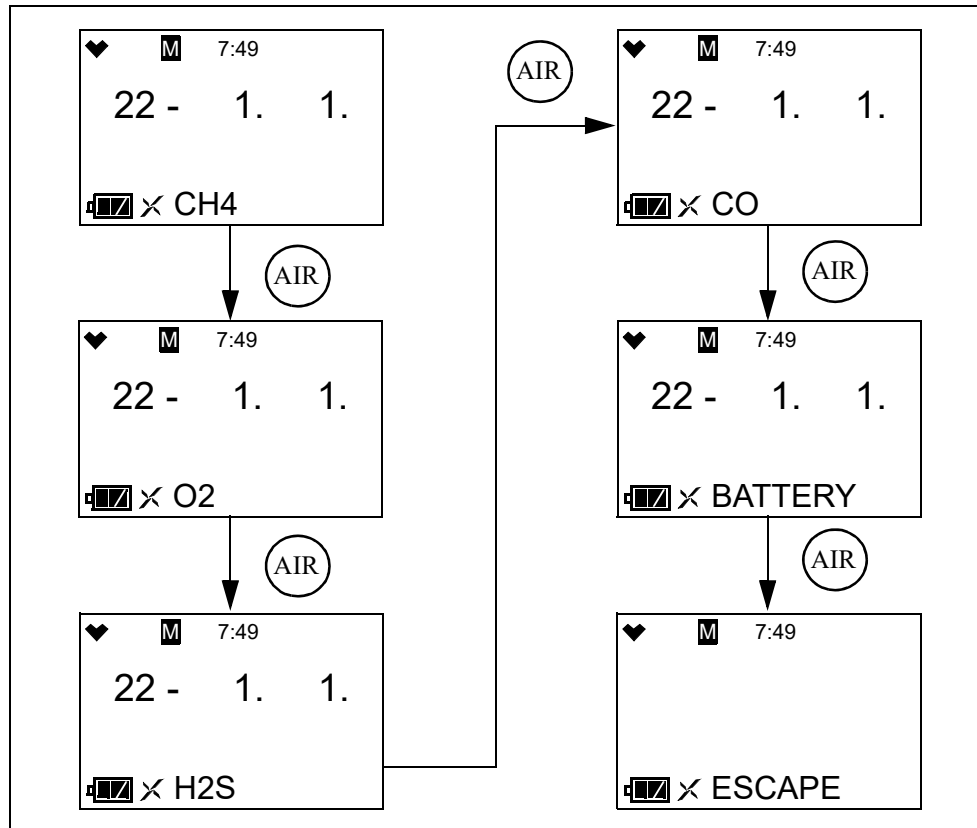

- To change the replacement date:
 - With the desired item displayed, press POWER MODE.
 - Press POWER MODE again to set the replacement date to the current date.
- Use the AIR button to scroll to the **ESCAPE** menu item.
- Press POWER MODE to return to the **SEN.DATE** menu item in Maintenance Mode.
- See “Entering Measuring Mode (START)” on page 123 to enter Measuring Mode.

Performing a Bump Test (BUMP)

See “Performing a Bump Test (BUMP)” on page 63 for a description of the **BUMP** menu item.

Setting Alarms to Latching or Self-Resetting (LATCH)

ON (factory setting): The GX-Force remains in alarm until the alarm condition passes *and* POWER MODE is pressed.

OFF: The GX-Force automatically resets an alarm when the alarm condition passes.

1. While in Maintenance Mode, press AIR to scroll to **LATCH**.



2. Press POWER MODE. The current setting flashes.
3. Use AIR to display the desired setting.
4. Press POWER MODE to save the setting and return to the **LATCH** menu item.
5. See “Entering Measuring Mode (START)” on page 123 to enter Measuring Mode.

Turning the Alarm Silence Function On/Off (ALM.SLNC)

ON (factory setting): The buzzer can be silenced during an alarm condition by pressing POWER MODE or AIR.

OFF: The buzzer cannot be silenced during an alarm condition by pressing POWER MODE or AIR. The alarm condition must first pass before the buzzer can be silenced.

1. While in Maintenance Mode, press AIR to scroll to **ALM.SLNC**.

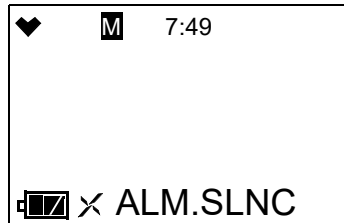

2. Press POWER MODE. The current setting flashes.
3. Use AIR to display the desired setting.
4. Press POWER MODE to save the setting and return to the **ALM.SLNC** menu item in Maintenance Mode.
5. See “Entering Measuring Mode (START)” on page 123 to enter Measuring Mode.

Turning the Demand Zero Function On/Off (D.ZERO)

ON (factory setting): You can manually perform a fresh air adjust in Measuring Mode by pressing AIR.

OFF: You cannot manually perform a fresh air adjust in Measuring Mode.

1. While in Maintenance Mode, press AIR to scroll to **D.ZERO**.



2. Press POWER MODE. The current setting flashes.
3. Use AIR to display the desired setting.
4. Press POWER MODE to save the setting and return to the **D.ZERO** menu item in Maintenance Mode.
5. See “Entering Measuring Mode (START)” on page 123 to enter Measuring Mode.

Turning the Auto Zero Function On/Off (A.ZERO)

ON: The GX-Force asks if you want to perform a fresh air adjustment at the end of the startup sequence.

OFF (factory setting): The GX-Force does not ask if you want to perform a fresh air adjustment at the end of the startup sequence.

1. While in Maintenance Mode, press AIR to scroll to **A.ZERO**.

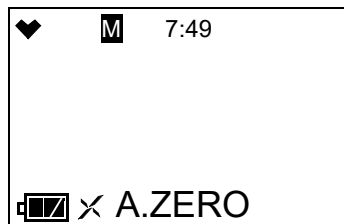

2. Press POWER MODE. The current setting flashes.
3. Use AIR to display the desired setting.
4. Press POWER MODE to save the setting and return to the **A.ZERO** menu item in Maintenance Mode.
5. See “Entering Measuring Mode (START)” on page 123 to enter Measuring Mode.

Turning the ID Display Function On/Off (ID DISP)

ON: The User ID and Station ID screens appear in startup sequence. If **DISP.SET** in User Mode is also set to **ON**, then the IDs can be changed in Display Mode.

OFF (factory setting): The User ID and Station ID screens do not appear in startup sequence and the IDs cannot be changed in Display Mode.

1. While in Maintenance Mode, press AIR to scroll to **ID DISP**.



2. Press POWER MODE. The current setting flashes.
3. Use AIR to display the desired setting.
4. Press POWER MODE to save the setting and return to the **ID DISP** menu item in Maintenance Mode.
5. See “Entering Measuring Mode (START)” on page 123 to enter Measuring Mode.

Turning the Zero Suppression On/Off (ZERO.SUP)

The **ZERO.SUP** setting is not intended for field adjustment. The default setting for each sensor is **ON**.

Sensor	Zero Suppression Value
Combustible Gas	2% LEL
O ₂	0.5% volume
H ₂ S	0.3 ppm
CO	2 ppm

Turning the Zero Follower On/Off (ZERO.FLW)

The **ZERO.FLW** setting is not intended for field adjustment. The default setting is **ON**. The oxygen channel does not support zero follower functionality.

User Mode Zero Suppression (ZSUP.DSP)

ON (factory setting): The **ZERO.SUP** menu item appears in User Mode.

OFF: The **ZERO.SUP** menu item does not appear in User Mode. The **ZERO.SUP** menu item is always available in Maintenance Mode.

User Mode Zero Follower (ZFLW.DSP)

ON: Zero follower menu item appears in User Mode.

OFF (factory setting): Zero follower menu item does not appear in User Mode. The zero follower menu item is always available in Maintenance Mode.

It is not normally necessary to have the zero follower menu item appear in User Mode. Contact RKI Instruments before turning this setting on.

Turning the Pump Off Display On/Off (POFF.DSP)

OFF (factory setting): The **PUMP.OFF** item does not appear in Display Mode.

ON: The **PUMP.OFF** item appears in Display Mode. **DISP.SET** in User Mode must also be set to **ON** (factory setting is **ON**) for the **PUMP.OFF** item to appear.

WARNING: *The GX-Force is not a gas monitoring device if the pump is turned off.*

Setting the Date/Time (DATE)

1. While in User Mode, press AIR to scroll to **DATE**.

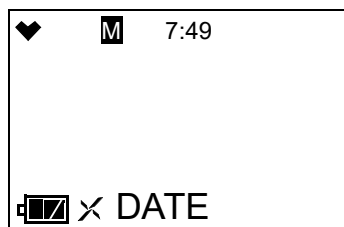

2. Press POWER MODE. The date and time display with the year flashing.

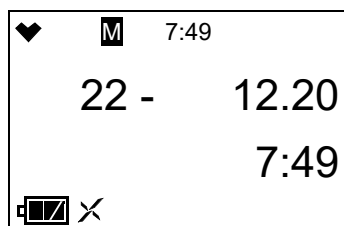

3. Use AIR to display the desired year.

4. Press POWER MODE to save the setting. The month setting flashes.
5. Repeat Step 3 and Step 4 to enter the month, day, hours, and minutes settings. The date and time are saved and the instrument returns to the **DATE** menu item in Maintenance Mode.
6. See “Entering Measuring Mode (START)” on page 123 to enter Measuring Mode.

Turning the Password On/Off (PASS - - W)

ON (factory setting): The GX-Force prompts you for a password when you enter Maintenance Mode. The factory-set password is **2202** but it can be changed as desired.

OFF: No password is required to enter Maintenance Mode.

1. While in Maintenance Mode, press AIR to scroll to **PASS - - W**.

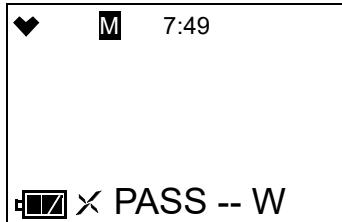

2. Press POWER MODE. The current setting flashes.
3. Use AIR to display the desired setting.
4. If you selected **OFF**, press POWER MODE to save the setting and return to the **PASS - - W** item in Maintenance Mode.

If you selected **ON**, continue with Step 5.

5. Press POWER MODE. The Set Password Screen appears. The current password appears and the first digit flashes.

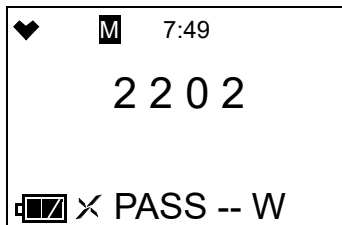

6. Use AIR to display a number from 0 to 9.
7. Press POWER MODE to enter the selection and advance to the next number. To go back a number, press and hold AIR and POWER MODE for a few seconds.
8. Repeat Step 6 and Step 7 to select the remaining numbers. When you press POWER MODE to enter the last number, the password is saved and the instrument returns to the **PASS - - W** item in Maintenance Mode.
9. See “Entering Measuring Mode (START)” on page 123 to enter Measuring Mode.

Viewing the ROM/SUM (ROM/SUM)

The **ROM/SUM** screen shows the instrument's firmware version and the firmware checksum.

1. While in Maintenance Mode, press AIR to scroll to **ROM/SUM**.

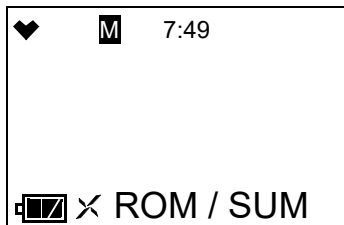

2. Press POWER MODE. The screen cycles through the main board's ROM/SUM, the sensor board's ROM/SUM, and the gas list's ROM/SUM. The ROM is the top value and the SUM is the bottom value.

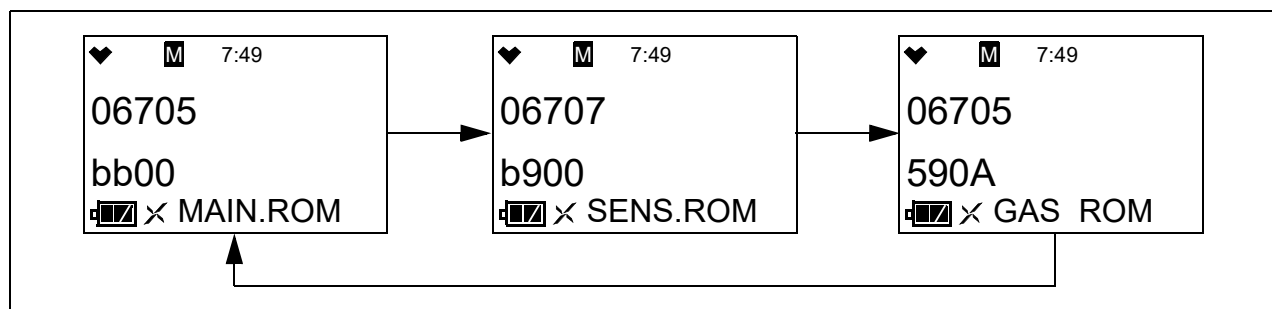

3. Press POWER MODE to return to the **ROM/SUM** menu item in Maintenance Mode.
4. See “Entering Measuring Mode (START)” on page 123 to enter Measuring Mode.

Performing a Flow Pump Adjustment (FLOW.ADJ)

This menu item is not intended for field use and does not affect the instrument. The GX-Force's low flow tolerance is factory adjusted so that a low flow setpoint adjustment is not necessary.

Performing a Default (M.DEF)

Performing a default operation in Maintenance Mode returns all parameters to their RKI factory settings.

1. While in Maintenance Mode, press AIR to scroll to **M.DEF**.



2. Press POWER MODE to continue. Press AIR to return to the **M.DEF** menu item in Maintenance Mode.

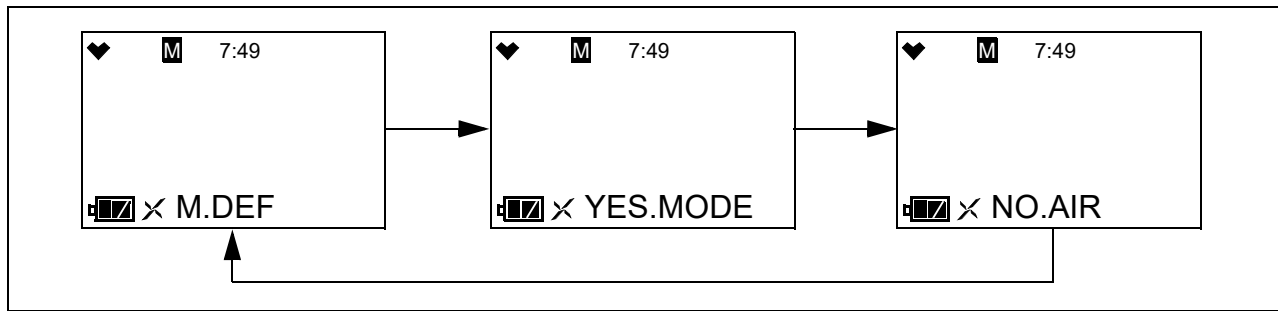

3. Press POWER MODE to perform a default operation. The instrument asks if you are sure you want to perform a default operation.

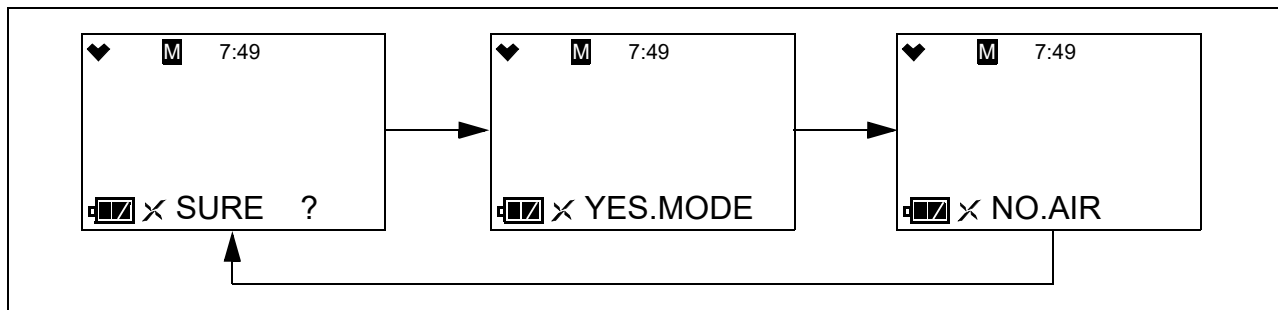

4. Press POWER MODE to perform a default operation. Press AIR to return to **M.DEF** menu item in Maintenance Mode.
5. The instrument beeps twice and returns to the **M.DEF** menu item in Maintenance Mode.
6. See “Entering Measuring Mode (START)” on page 123 to enter Measuring Mode.

Entering Measuring Mode (START)

1. While in Maintenance Mode, press AIR to scroll to **START**.



2. Press POWER MODE. The instrument begins its warmup sequence.

Appendix B: Gas Select Mode

Overview

This appendix describes the GX-Force in Gas Select Mode. The GX-Force is factory-set to suit most applications. Update settings in Gas Select Mode only if required for your specific application. A description of the Gas Select Mode items is shown in Table 18.

Table 18: Gas Select Mode Menu Items

Menu Item (Page # of Description)	Description
GAS.COMB (page 126)	Turn channels on or off and change target gas for each channel.
SAVE--AP (page 129)	Set the current alarm points as the default alarm points.
MAX.SPAN (page 130)	ON : Maximum span screen appears after a successful calibration. OFF (factory setting): No maximum span screen appears.
STEALTH (page 130)	<u>STEALTH</u> <ul style="list-style-type: none">• ON: No backlight, LED, or buzzer operation.• OFF (factory setting): Backlight, LED, and buzzer operate normally.
	<u>VIB</u> <p>This setting has no effect unless STEALTH is set to ON.</p> <ul style="list-style-type: none">• ON: Vibrator activates for alarm conditions.• OFF (factory setting): Vibrator does not activate in any situation.
CHG LEL (page 131)	STANDARD (factory setting): Apply standard settings for lower explosive limit's ppm level. IEC : Apply IEC standards for the lower explosive limit's ppm level. ISO : Apply ISO standards for the lower explosive limit's ppm level.
START (page 133)	Enter Measuring Mode

Tips for Using Gas Select Mode

To scroll from one menu item to the next, press AIR. To reverse the scrolling direction:

1. Press and hold AIR.
2. Immediately press POWER/MODE and then release both buttons.
3. The scrolling direction returns to the original direction when you exit and reenter a menu.

To skip an item when a question is asked, press AIR.

To enter an item and to save any changes, press POWER MODE.

- To change a flashing parameter, press AIR. To reverse the direction of change (i.e. from increasing to decreasing or vice versa):
 - a. Press and hold AIR.
 - b. Immediately press POWER MODE and then release both buttons.
- To exit an entered menu item without saving a change, press and hold AIR and POWER MODE for a few seconds.

Entering Gas Select Mode

WARNING: The GX-Force is not in operation as a gas detector while in Gas Select Mode.

1. Take the GX-Force to a non-hazardous location and turn it off if it is on.
2. Press and hold AIR, then press and hold POWER MODE. You will hear a beep after one second. Continue to hold the buttons down.
3. You will hear a second beep. Continue to hold the buttons down.
4. When you hear a third beep, release the buttons.
5. A password screen appears. The first digit flashes. The password is **2014**.

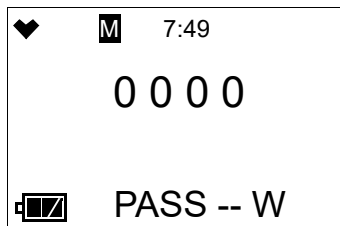

6. Use AIR to select each password number then press POWER MODE to save it and move on to the next number. To go back a number, press and hold AIR and POWER MODE for a few seconds. To reverse the direction of change (ie. from increasing to decreasing or vice versa):
 - a. Press and hold AIR.
 - b. Immediately press POWER MODE and then release both buttons.
7. The **GAS.COMB** menu item displays.

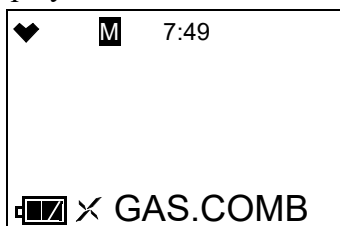

8. **M** at the top of the screen indicates that the GX-Force is in Gas Select Mode.
9. Use AIR to move through the Gas Select Mode menu items.

Changing the Gas Combination (GAS.COMB)

The **GAS.COMB** menu item allows you to turn channels on and off and change each channel's target gas.

If you want the combustible gas channel to be calibrated to a specific target gas, select that target gas here and then calibrate to it in User Mode (see page 70).

1. While in Gas Select Mode, press AIR to scroll to **GAS.COMB**.



2. Press POWER MODE. The first channel displays.

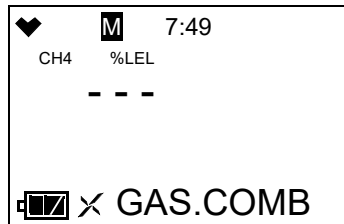

3. Press AIR to scroll through to the instrument channel whose target gas you want to change.

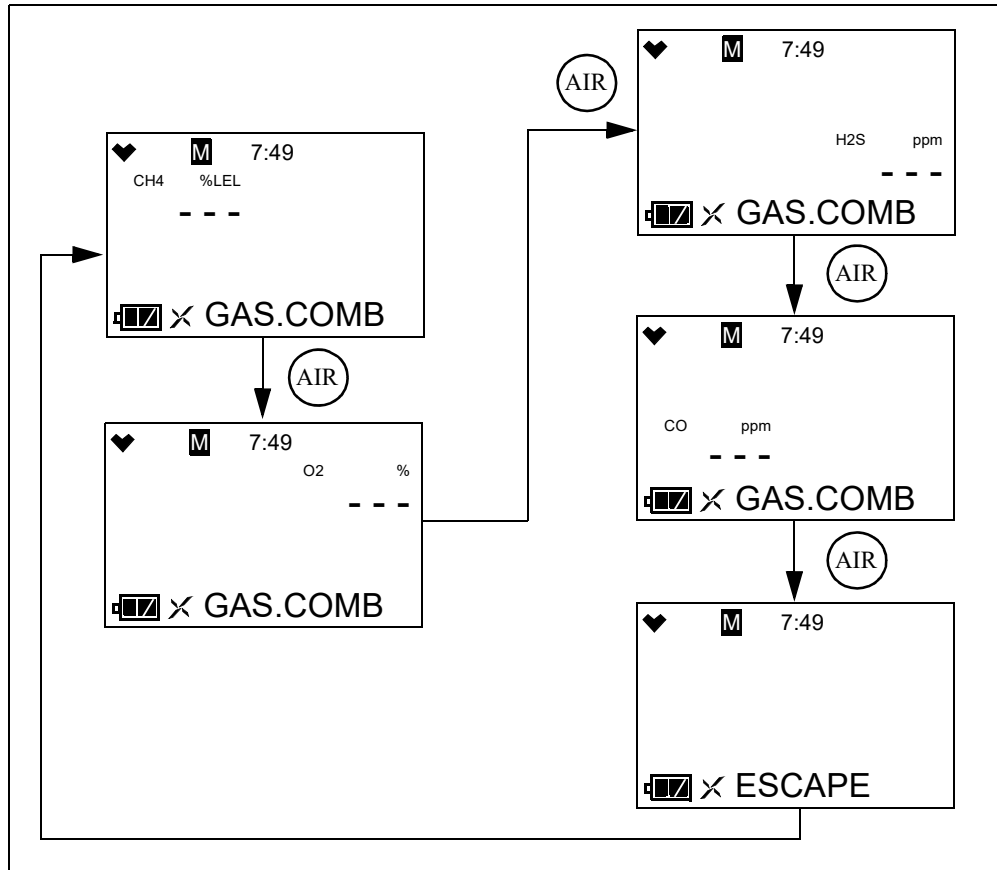

4. Press POWER MODE.
5. The target gas for the selected channel flashes. In the example below, the combustible gas channel is selected.

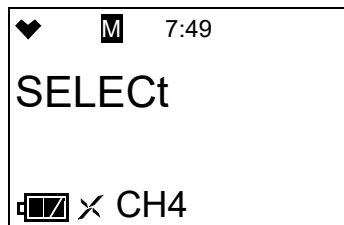

6. Use AIR to change the target gas or turn the channel off.

Table 19: Target Gas Options for Each Channel

Channel	Target Gas Options
Combustible Gas	<ul style="list-style-type: none"> • CH₄ (methane) • i-C₄H₁₀ (isobutane) • H₂ (hydrogen) • CH₃OH (methanol) • C₂H₂ (acetylene) • C₂H₄ (ethylene) • C₂H₆ (ethane) • C₂H₅OH (ethanol) • C₃H₆ (propylene) • C₃H₆O (acetone) • C₃H₈ (propane) • C₄H₆ (butyne) • C₅H₁₀ (cyclopentane) • C₆H₆ (benzene) • n-C₆H₁₄ (hexane) • C₇H₈ (toluene) • n-C₇H₁₆ (heptane) • C₈H₁₀ (xylene) • n-C₉H₂₀ (nonane) • EtAc (ethyl acetate) • IPA (isopropyl alcohol) • MEK (methyl ethyl ketone) • MMA (methyl methacrylate) • DME (dimethyl ether) • MIBK (methyl isobutyl ketone) • THF (tetrahydrofuran) • n-C₅H₁₂ (n-pentane) • CH₄_VOL (methane %volume)* • ----- (off)
O ₂	<ul style="list-style-type: none"> • O₂ (oxygen) • ----- (off)
H ₂ S	<ul style="list-style-type: none"> • H₂S (hydrogen sulfide for dual CO/H₂S sensor) • H₂S SIN (hydrogen sulfide for single-gas H₂S sensor) • H₂_CO-H₂ (hydrogen-compensated CO) • ----- (off)
CO	<ul style="list-style-type: none"> • CO (carbon monoxide for dual CO/H₂S sensor or single-gas CO sensor) • CO_CO-H₂ (hydrogen-compensated CO) • HCN** • ----- (off)

* If CH₄_VOL is selected, the **CHG LEL** item in Gas Select Mode has no effect on operation.

** Although HCN is in the list of CO channel options, the GX-Force does not support this target gas.

7. Press POWER MODE to save the setting.
8. The instrument returns to the channel selection screen.
9. Repeat Step 3 - Step 8 to change the target gas for other channels.
10. Use AIR to scroll to **ESCAPE** and press POWER MODE.
11. The instrument returns to the **GAS.COMB** menu item in Gas Select Mode.
12. See “Exiting Gas Select Mode (START)” on page 133 to enter Measuring Mode.

Saving the Alarm Points (SAVE--AP)

Performing a **SAVE -- AP** operation saves the current alarm setpoints.

Performing a **DEF ALMP** operation in the **ALARM-PT** User Mode menu item sets the instrument's alarm points to those saved during the **SAVE -- AP** operation (if performed).

Performing a **SAVE -- AP** operation has no effect on an **M.DEF** in Maintenance Mode. An **M.DEF** operation returns all instrument settings to the RKI default regardless of if a **SAVE -- AP** operation was performed.

1. While in Gas Select Mode, press AIR to scroll to **SAVE -- AP**.

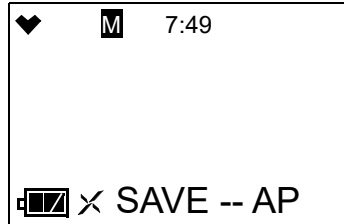

2. Press POWER MODE. The display cycles through the following screens.

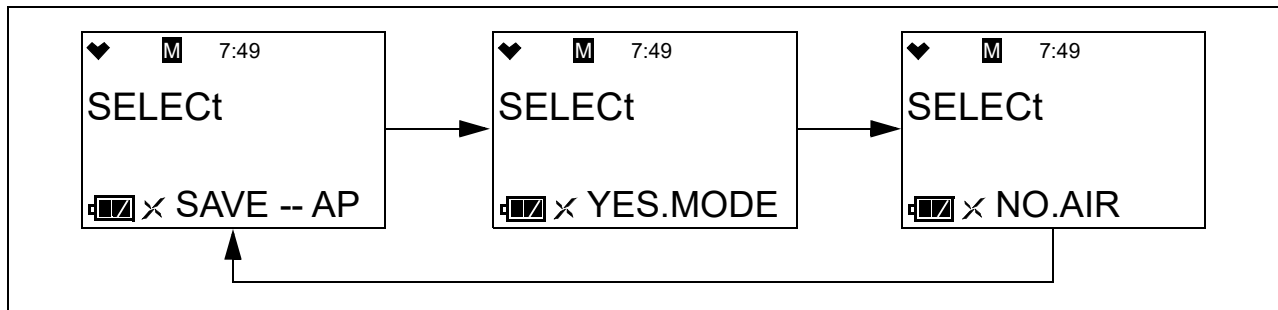

3. Press POWER MODE to save the current alarm point settings as the default.
4. The instrument returns to the **SAVE -- AP** menu item in Gas Select Mode.
5. See “Exiting Gas Select Mode (START)” on page 133 to enter Measuring Mode.

Turning Calibration Max Span On/Off (MAX.SPAN)

ON: After a passed calibration, the GX-Force displays the maximum possible adjustment it could have made to the response reading. If the combustible gas channel was calibrated with 50% LEL gas and the maximum indicated span is 95% LEL, this means that there was enough adjustment left on that channel to set the reading to 95% LEL when the detector was exposed to 50% LEL gas. If the maximum span value is close to the calibration gas value, for example if it is 53% LEL when exposed to 50% LEL gas, the sensor should be replaced soon. The upper limit on the maximum adjustment indicated for all channels except for oxygen is either twice the calibration value or full scale, whichever is lower. The upper limit on the maximum adjustment indicated for the oxygen channel is 25.0% volume.

OFF (factory setting): There is no maximum span indication at the end of a calibration.

1. While in Gas Select Mode, press AIR to scroll to **MAX.SPAN**.



2. Press POWER MODE. The current setting flashes.
3. Use AIR to display the desired setting.
4. Press POWER MODE to save the setting and return to the **MAX.SPAN** menu item in Gas Select Mode.
5. See “Exiting Gas Select Mode (START)” on page 133 to enter Measuring Mode.

Stealth and Vibrator Settings (STEALTH)

STEALTH

ON:

- The instrument’s backlight does not come on, regardless of the **BL TIME** setting.
- The instrument’s LEDs do not come on for any reason, even alarm conditions.
- The instrument’s buzzer does not sound for any reason, even alarm conditions.
- An “S” appears at the top of the LCD.

OFF (factory setting): The instrument’s backlight and LEDs operate normally.

VIB

The **VIB** setting only affects instrument operation if **STEALTH** is set to **On**.

ON: The vibrator activates for alarm conditions. It can be useful to have this feature turned on if you have also turned **STEALTH** on.

OFF (factory setting): The vibrator does not activate for any reason.

1. While in Gas Select Mode, press AIR to scroll to **STEALTH**.

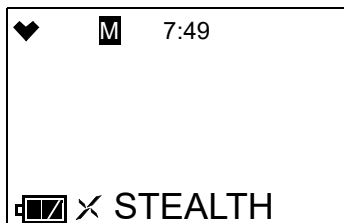

2. Press POWER MODE. The current **STEALTH** setting flashes.
3. Use AIR to display the desired setting.
4. Press POWER MODE. The current **VIB** setting flashes.
5. Use AIR to display the desired setting.
6. Press POWER MODE to save the setting and return to the **STEALTH** menu item in Gas Select Mode.
7. See “Exiting Gas Select Mode (START)” on page 133 to enter Measuring Mode.

LEL Definition (CHG LEL)

NOTE: If **CH4_VOL** is selected for the combustible gas sensor in the **GAS.COMB** menu item, the **CHG LEL** setting has no effect on operation.

The **CHG LEL** menu item defines what standard the instrument follows in determining the LEL (lower explosive limit) for the combustible channel’s target gas.

STANDARD (factory setting): Apply the standard settings for the lower explosive limit’s ppm level.

IEC: Apply the IEC settings (per IEC 60079-20-1 2010[ed1.0]) for the lower explosive limit’s ppm level.

ISO: Apply the ISO settings (per ISO 10156 2017) for the lower explosive limit’s ppm level.

Gas	Standard (ppm)	IEC (ppm)	ISO (ppm)
Methane (CH4)	50,000	44,000	44,000
Isobutane (i-C4H10)	18,000	13,000	15,000
Hydrogen (H2)	40,000	40,000	40,000

Gas	Standard (ppm)	IEC (ppm)	ISO (ppm)
Methanol (CH ₃ OH)	55,000	60,000	60,000
Acetylene (C ₂ H ₂)	15,000	23,000	23,000
Ethylene (C ₂ H ₄)	27,000	23,000	24,000
Ethane (C ₂ H ₆)	30,000	24,000	24,000
Ethanol (C ₂ H ₅ OH)	33,000	31,000	31,000
Propylene (C ₃ H ₆)	20,000	20,000	18,000
Acetone (C ₃ H ₆ O)	21,500	25,000	25,000
Propane (C ₃ H ₈)	20,000	17,000	17,000
Butadiene (C ₄ H ₆)	11,000	14,000	14,000
Cyclopentane (C ₅ H ₁₀)	14,000	14,000	14,000*
N-pentane (n-C ₅ H ₁₂)	15,000	11,000	11,000
Benzene (C ₆ H ₆)	12,000	12,000	12,000
N-hexane (n-C ₆ H ₁₄)	12,000	10,000	10,000
Toluene (C ₇ H ₈)	12,000	10,000	10,000
N-heptane (n-C ₇ H ₁₆)	11,000	8,500	8,000
Xylene (C ₈ H ₁₀)	10,000	10,000	10,000*
N-nonane (n-C ₉ H ₂₀)	7,000	7,000	7,000
Ethyl acetate (EtAc)	21,000	20,000	20,000
Isopropyl alcohol (IPA)	20,000	20,000	20,000*
Methyl ethyl ketone (MEK)	18,000	15,000	15,000
Methyl methacrylate (MMA)	17,000	17,000	17,000*
Dimethyl ether (DME)	30,000	27,000	27,000
Methyl isobutyl ketone (MIBK)	12,000	12,000	12,000*
Tetrahydrofuran (THK)	20,000	15,000	15,000*

* Values are actually IEC because no ISO definition exists for these gases.

1. While in Gas Select Mode, press AIR to scroll to **CHG LEL**.

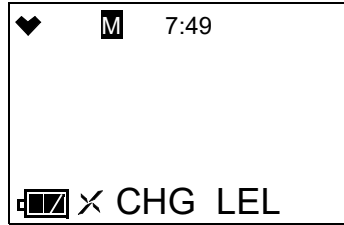

2. Press POWER MODE. The current setting flashes.
3. Use AIR to display the desired setting.
4. Press POWER MODE to save the setting and return to the **CHG LEL** menu item in Gas Select Mode.
5. See “Exiting Gas Select Mode (START)” on page 133 to enter Measuring Mode.

Exiting Gas Select Mode (START)

1. While in Gas Select Mode, press AIR to scroll to **START**.



2. Press POWER MODE. The instrument begins its warm-up sequence.

Appendix C: Interference Information

All interference response values shown in this appendix are approximate. Response may vary between sensors.

ESR-A13i-H2S, H₂S Detection

Table 20: Interference Chart for ESR-A13i-H2S, H₂S Detection

Gas	Chemical Formula	Concentration	Indication Value
Acetone	C ₃ H ₆ O	0.54 vol%	0.0 ppm
Acetylene	C ₂ H ₂	100 ppm	0.0 ppm
Ammonia	NH ₃	38.6 ppm	0.0 ppm
Benzene	C ₆ H ₆	0.30 vol%	0.0 ppm
Carbon Dioxide	CO ₂	20.0 vol%	0.0 ppm
Carbon Monoxide	CO	100.0 ppm	0.2 ppm
Chlorine	CL ₂	2.0 ppm	0.0 ppm
Cyclopentane	C ₅ H ₁₀	0.35 vol%	0.0 ppm
Ethane	C ₂ H ₆	0.75 vol%	0.0 ppm [*]
Ethanol	C ₂ H ₅ OH	0.83 vol%	-0.5 ppm [*]
Ethyl Acetate	C ₄ H ₈ O ₂	0.53 vol%	-0.1 ppm [*]
Fluorine	F ₂	1.6 ppm	0.0 ppm
Hydrogen	H ₂	500 ppm	0.2 ppm
Hydrogen Bromide	HBr	9.0 ppm	0.0 ppm
Hydrogen Chloride	HCl	3.2 ppm	0.0 ppm
Isobutane	i-C ₄ H ₁₀	0.45 vol%	0.0 ppm
Isobuten	C ₄ H ₈	1000 ppm	0.1 ppm
Isopropyl Alcohol	C ₃ H ₈ O	2.0 vol%	-0.5 ppm
Methane	CH ₄	1.26 vol%	0.0 ppm
Methanol	CH ₃ OH	1.38 vol%	-0.6 ppm [*]
Methyl Ethyl Ketone	C ₄ H ₈ O	0.45 vol%	0.0 ppm

Table 20: Interference Chart for ESR-A13i-H2S, H₂S Detection

Gas	Chemical Formula	Concentration	Indication Value
Methyl Isobutyl Ketone	C ₆ H ₁₂ O	0.30 vol%	0.0 ppm
Methyl Methacrylate	C ₅ H ₈ O ₂	0.43 vol%	0.1 ppm*
n-Hexane	n-C ₆ H ₁₄	0.30 vol%	0.0 ppm
Nitrogen Dioxide	NO ₂	5.0 ppm	-0.4 ppm
Nitrogen Monoxide	NO	99.2 ppm	2.6 ppm
Nonane	n-C ₉ H ₂₀	0.18 vol%	0.0 ppm
Ozone	O ₃	0.48 ppm	0.0 ppm
Phosphine	PH ₃	2.51 ppm	1.0 ppm
Propane	C ₃ H ₈	0.49 vol%	0.0 ppm
Propylene	C ₃ H ₆	0.5 vol%	-0.2 ppm
Sulfur Dioxide	SO ₂	25.0 ppm	0.0 ppm
Tetrahydrofuran	C ₄ H ₈ O	0.50 vol%	-0.4 ppm
Toluene	C ₇ H ₈	1.0 vol%	0.0 ppm
Xylene	C ₈ H ₁₀	0.25 vol%	0.0 pm

* The indicated value may fluctuate when exposed to this gas.

ESR-A13P-CO, CO Detection

Table 21: Interference Chart for ESR-A13P-CO, CO Detection

Gas	Chemical Formula	Concentration	Indication Value
Acetone	$(\text{CH}_3)_2\text{CO}$	5380 ppm	0 ppm
Acetylene	C_2H_2	99.6 ppm	50 ppm
Ammonia	NH_3	255 ppm	1 ppm
Arsine	AsH_3	1.1 ppm	4 ppm
Benzene	C_6H_6	0.3 vol%	-1 ppm
Carbon Dioxide	CO_2	100 vol%	8 ppm
Chlorine	Cl_2	0.8 ppm	0 ppm
Cyclopentane	C_5H_{10}	0.35 vol%	0 ppm
Diborane	B_2H_6	5.25 ppm	2 ppm
Ethane	C_2H_6	0.75 vol%	-1 ppm
Ethanol	$\text{CH}_3\text{CH}_2\text{OH}$	0.825 vol%	2 ppm *
Ethyl Acetate	$\text{CH}_3\text{COOH}_2\text{CH}_3$	0.525 vol%	-1 ppm
Fluorine	F_2	1.6 ppm	-1 ppm
Germane	GeH_4	10.2 ppm	3 ppm
Hydrogen	H_2	100 ppm	11 ppm
Hydrogen Chloride	HCl	11.7 ppm	-1 ppm
Hydrogen Cyanide	HCN	1.8 ppm	-1 ppm
Hydrogen Selenide	H_2Se	1 ppm	1 ppm
Hydrogen Sulfide	H_2S	30 ppm	0 ppm
Isobutane	C_4H_{10}	0.45 vol%	-1 ppm
Isobuten	$(\text{CH}_3)_2\text{C}=\text{CH}_2$	1000 ppm	2 ppm
Isopropyl Alcohol	$(\text{CH}_3)_2\text{CHOH}$	0.5 vol%	-1 ppm
Methane	CH_4	1.25 vol%	0 ppm
Methanol	CH_3OH	1000 ppm	3 ppm
Methyl Ethyl Ketone	$\text{C}_4\text{H}_8\text{O}$	0.45 vol%	-1 ppm

Table 21: Interference Chart for ESR-A13P-CO, CO Detection

Gas	Chemical Formula	Concentration	Indication Value
Methyl Isobutyl Ketone	C ₆ H ₁₂ O	3000 ppm	-1 ppm
Methyl Methacrylate	C ₅ H ₈ O ₂	0.425 vol%	0 ppm
n-Heptane	CH ₃ (CH ₂) ₅ CH ₃	0.275 vol%	-1 ppm
n-Hexane	CH ₃ (CH ₂) ₄ CH ₃	0.3 vol%	0 ppm
Nitrogen Dioxide	NO ₂	50.5 ppm	1 ppm
Nitrogen Monoxide	NO	99.2 ppm	53 ppm
Nonane	CH ₃ (CH ₂) ₇ CH ₃	0.175 vol%	0 ppm
Ozone	O ₃	1.8 ppm	0 ppm
Phosphine	PH ₃	2.5 ppm	3 ppm
Propane	C ₃ H ₈	0.5 vol%	0 ppm
Propylene	C ₃ H ₆	5000 ppm	16 ppm
Silane	SiH ₄	29.9 ppm	27 ppm
Sulfur Dioxide	SO ₂	30 ppm	0 ppm
Tetrahydrofuran	C ₄ H ₈ O	0.5 vol%	0 ppm
Toluene	C ₆ H ₅ CH ₃	3000 ppm	0 ppm
Xylene	C ₆ H ₄ (CH ₃) ₂	2500 ppm	0 ppm

* The indicated value may fluctuate when exposed to this gas.

ESR-A1CP-COH, H₂-Compensated CO Detection

Table 22: Interference Chart for ESR-A1CP-COH, H₂-Compensated CO Detection

Gas	Chemical Formula	Concentration	Indication Value
Acetone	C ₃ H ₆ O	0.54 vol%	1 ppm
Acetylene	C ₂ H ₂	100 ppm	109 ppm
Ammonia	NH ₃	38.6 ppm	0 ppm
Benzene	C ₆ H ₆	0.30 vol%	0 ppm
Carbon Dioxide	CO ₂	20.0 vol%	0 ppm
Chlorine	Cl ₂	2.0 ppm	-1 ppm
Cyclopentane	C ₅ H ₁₀	0.35 vol%	1 ppm
Ethane	C ₂ H ₆	0.75 vol%	0 ppm
Ethanol	C ₂ H ₅ OH	0.83 vol%	4 ppm [*]
Ethyl Acetate	C ₄ H ₈ O ₂	0.53 vol%	1 ppm
Fluorine	F ₂	1.6 ppm	-1 ppm
Hydrogen	H ₂	500 ppm	7 ppm
Hydrogen Bromide	HBr	9.0 ppm	0 ppm
Hydrogen Chloride	HCl	15.8 ppm	0 ppm
Hydrogen Sulfide	H ₂ S	24.2 ppm	0 ppm
Isobutane	i-C ₄ H ₁₀	0.45 vol%	0 ppm
Isobuten	C ₄ H ₈ O	1000 ppm	3 ppm
Isopropyl Alcohol	C ₃ H ₈ O	0.50 vol%	0 ppm
Nitrogen Monoxide	NO	99.2 ppm	53 ppm
Nitrogen Dioxide	NO ₂	50.5 ppm	0 ppm
Methane	CH ₄	1.26 vol%	1 ppm
Methanol	CH ₃ OH	1.38 vol%	131 ppm [*]
Methyl Ethyl Ketone	C ₄ H ₈ O	0.45 vol%	0 ppm
Methyl Isobutyl Ketone	C ₆ H ₁₂ O	0.30 vol%	0 ppm
Methyl Methacrylate	C ₅ H ₈ O ₂	0.43 vol%	1 ppm

Table 22: Interference Chart for ESR-A1CP-COH, H₂-Compensated CO Detection

Gas	Chemical Formula	Concentration	Indication Value
n-Hexane	n-C ₆ H ₁₄	0.30 vol%	1 ppm
Nonane	n-C ₉ H ₂₀	0.18 vol%	0 ppm
Ozone	O ₃	0.48 ppm	0 ppm
Phosphine	PH ₃	2.51 ppm	3 ppm
Propane	C ₃ H ₈	0.49 vol%	0 ppm
Propylene	C ₃ H ₆	0.50 vol%	78 ppm *
Sulfur Dioxide	SO ₂	25.0 ppm	1 ppm
Tetrahydrofuran	C ₄ H ₈ O	0.50 vol%	1 ppm
Toluene	C ₇ H ₈	0.30 vol%	1 ppm
Xylene	C ₈ H ₁₀	0.25 vol%	0 ppm

* The indicated value may fluctuate when exposed to this gas.

ESR-A1DP-COHS, CO Detection

Table 23: Interference Chart for ESR-A1DP-COHS, CO Detection

Gas	Chemical Formula	Concentration	Indication Value
Acetone	$(\text{CH}_3)_2\text{CO}$	0.538 vol%	-1 ppm
Acetylene	C_2H_2	99.6 ppm	84 ppm
Ammonia	NH_3	255 ppm	2 ppm
Arsine	AsH_3	1.1 ppm	4 ppm
Benzene	C_6H_6	0.3 vol%	-1 ppm
Carbon Dioxide	CO_2	100 vol%	8 ppm
Chlorine	Cl_2	0.8 ppm	-1 ppm
Cyclopentane	C_5H_{10}	0.35 vol%	0 ppm
Diborane	B_2H_6	5.25 ppm	2 ppm
Ethane	C_2H_6	0.75 vol%	0 ppm
Ethanol	$\text{CH}_3\text{CH}_2\text{OH}$	0.825 vol%	25 ppm *
Ethyl Acetate	$\text{CH}_3\text{COOCH}_2\text{CH}_3$	0.525 vol%	9 ppm *
Fluorine	F_2	1.6 ppm	0 ppm
Germane	GeH_4	10.2 ppm	7 ppm
Hydrogen	H_2	100 ppm	17 ppm
Hydrogen Chloride	HCl	11.7 ppm	-1 ppm
Hydrogen Cyanide	HCN	1.8 ppm	-1 ppm
Hydrogen Selenide	H_2Se	1 ppm	2 ppm
Hydrogen Sulfide	H_2S	30 ppm	2 ppm
Isobutane	C_4H_{10}	0.45 vol%	0 ppm
Isobuten	$(\text{CH}_3)_2\text{C}=\text{CH}_2$	1000 ppm	9 ppm
Isopropyl Alcohol	$(\text{CH}_3)_2\text{CHOH}$	0.5 vol%	15 ppm *
Methane	CH_4	1.25 vol%	-1 ppm
Methanol	CH_3OH	1000 ppm	10 ppm *
Methyl Ethyl Ketone	$\text{C}_4\text{H}_8\text{O}$	0.45 vol%	-1 ppm

Table 23: Interference Chart for ESR-A1DP-COHS, CO Detection

Gas	Chemical Formula	Concentration	Indication Value
Methyl Isobutyl Ketone	C ₆ H ₁₂ O	0.3 vol%	0 ppm
Methyl Methacrylate	C ₅ H ₈ O ₂	0.425 vol%	2 ppm
n-Heptane	CH ₃ (CH ₂) ₅ CH ₃	0.275 vol%	-1 ppm
n-Hexane	CH ₃ (CH ₂) ₄ CH ₃	0.3 vol%	0 ppm
Nitrogen Dioxide	NO ₂	50.5 ppm	1 ppm
Nitrogen Monoxide	NO	99.2 ppm	38 ppm
Nonane	CH ₃ (CH ₂) ₇ CH ₃	0.175 vol%	0 ppm
Ozone	O ₃	1.8 ppm	0 ppm
Phosphine	PH ₃	2.5 ppm	3 ppm
Propane	C ₃ H ₈	0.5 vol%	0 ppm
Propylene	C ₃ H ₆	0.5 vol%	42 ppm*
Silane	SiH ₄	29.9 ppm	46 ppm
Sulfur Dioxide	SO ₂	30 ppm	3 ppm
Tetrahydrofuran	C ₄ H ₈ O	0.5 vol%	21 ppm
Toluene	C ₆ H ₅ CH ₃	0.3 vol%	0 ppm
Xylene	C ₆ H ₄ (CH ₃) ₂	0.25 vol%	0 ppm

* The indicated value may fluctuate when exposed to this gas.

ESR-A1DP-COHS, H₂S Detection

Table 24: Interference Chart for ESR-A1DP-COHS, H₂S Detection

Gas	Chemical Formula	Concentration	Indication Value
Acetone	CH ₃ COCH ₃	0.538 vol%	-0.1 ppm
Acetylene	C ₂ H ₂	99.6 ppm	-0.1 ppm
Ammonia	NH ₃	250 ppm	-0.1 ppm
Arsine	AsH ₃	1.1 ppm	0.5 ppm
Benzene	C ₆ H ₆	0.3 vol%	-0.1 ppm
Carbon Dioxide	CO ₂	100 vol%	-0.1 ppm
Carbon Monoxide	CO	1000 ppm	2.6 ppm
Chlorine	Cl ₂	0.8 ppm	-0.1 ppm
Cyclopentane	C ₅ H ₁₀	0.35 vol%	-0.1 ppm
Diborane	B ₂ H ₆	5.25 ppm	0.2 ppm
Ethane	C ₂ H ₆	0.75 vol%	0.0 ppm
Ethanol	CH ₃ CH ₂ OH	0.825 vol%	0.5 ppm
Ethyl Acetate	CH ₃ COOCH ₂ CH ₃	0.525 vol%	-0.1 ppm
Fluorine	F ₂	1.6 ppm	-0.1 ppm
Germane	GeH ₄	10.2 ppm	0.3 ppm
Hydrogen	H ₂	2000 ppm	1.3 ppm
Hydrogen Chloride	HCl	11.7 ppm	-0.2 ppm
Hydrogen Cyanide	HCN	1.8 ppm	0.0 ppm
Hydrogen Selenide	H ₂ Se	1 ppm	0.3 ppm
Isobutane	C ₄ H ₁₀	0.45 vol%	-0.1 ppm
Isobuten	CH ₂ CH(CH ₃) ₂	1000 ppm	0.1 ppm
Isopropyl Alcohol	CH ₃ C(OH)CH ₃	0.5 vol%	0.0 ppm
Methane	CH ₄	1.25 vol%	-0.1 ppm
Methanol	CH ₃ OH	1.375 vol%	0.5 ppm

Table 24: Interference Chart for ESR-A1DP-COHS, H₂S Detection

Gas	Chemical Formula	Concentration	Indication Value
Methyl Ethyl Ketone	C ₄ H ₈ O	0.45 vol%	0.3 ppm
Methyl Isobutyl Ketone	C ₆ H ₁₂ O	0.3 vol%	-0.1 ppm
Methyl Methacrylate	C ₅ H ₈ O ₂	0.425 vol%	-0.1 ppm
n-Heptane	CH ₃ (CH ₂) ₅ CH ₃	0.275 vol%	-0.1 ppm
n-Hexane	CH ₃ (CH ₂) ₄ CH ₃	0.3 vol%	-0.1 ppm
Nitrogen Dioxide	NO ₂	50.5 ppm	-4.6 ppm
Nitrogen Monoxide	NO	99.2 ppm	6.0 ppm
Nonane	CH ₃ (CH ₂) ₇ CH ₃	0.175 vol%	0.2 ppm
Ozone	O ₃	1.8 ppm	-0.1 ppm
Phosphine	PH ₃	2.5 ppm	1.5 ppm
Propane	C ₃ H ₈	0.5 vol%	-0.1 ppm
Propylene	C ₃ H ₆	0.5 vol%	-0.1 ppm
Silane	SiH ₄	29.9 ppm	0.6 ppm
Sulfur Dioxide	SO ₂	30 ppm	-0.1 ppm
Tetrahydrofuran	C ₄ H ₈ O	0.5 vol%	0.1 ppm
Toluene	C ₆ H ₅ CH ₃	0.3 vol%	-0.1 ppm
Xylene	C ₆ H ₅ (CH ₃) ₂	0.25 vol%	-0.1 ppm

Product Warranty

RKI Instruments, Inc. warrants gas alarm equipment sold by us to be free from defects in materials, workmanship, and performance for a period of one year from the date of shipment from RKI Instruments, Inc. Any parts found defective within that period will be repaired or replaced, at our option, free of charge. Parts must be returned to RKI Instruments, Inc. for repair or replacement. This warranty does not apply to those items which by their nature are subject to deterioration or consumption in normal service, and which must be cleaned, repaired or replaced on a routine basis. Examples of such items are:

- Absorbent cartridges
- Fuses
- Pump diaphragms and valves
- Batteries
- Filter elements

Warranty is voided by abuse including mechanical damage, alteration, rough handling, or repair procedures not in accordance with instruction manual. This warranty indicates the full extent of our liability, and we are not responsible for removal or replacement costs, local repair costs, transportation costs, or contingent expenses incurred without our prior approval.

THIS WARRANTY IS EXPRESSLY IN LIEU OF ANY AND ALL OTHER WARRANTIES AND REPRESENTATIONS, EXPRESSED OR IMPLIED, AND ALL OTHER OBLIGATIONS OR LIABILITIES ON THE PART OF RKI INSTRUMENTS, INC. INCLUDING BUT NOT LIMITED TO, THE WARRANTY OF MERCHANTABILITY OR FITNESS FOR A PARTICULAR PURPOSE. IN NO EVENT SHALL RKI INSTRUMENTS, INC. BE LIABLE FOR INDIRECT, INCIDENTAL, OR CONSEQUENTIAL LOSS OR DAMAGE OF ANY KIND CONNECTED WITH THE USE OF ITS PRODUCTS OR FAILURE OF ITS PRODUCTS TO FUNCTION OR OPERATE PROPERLY.

This warranty covers instruments and parts sold to users only by authorized distributors, dealers and representatives as appointed by RKI Instruments, Inc.

We do not assume indemnification for any accident or damage caused by the operation of this gas monitor and our warranty is limited to the replacement of parts or our complete goods. Warranty covers parts and labor performed at RKI Instruments, Inc. only, and does not cover field labor or shipment of parts back to RKI.



EU-Declaration of Conformity

Document No.: 320CE22123



We, RIKEN KEIKI Co., Ltd. 2-7-6, Azusawa, Itabashi-ku, Tokyo, 174-8744, Japan declare under our sole responsibility that the following product conforms to all the relevant provisions.

Product Name: Portable gas detector
Model: GX-Force

Council Directives		Applicable Standards
2014/34/EU	ATEX Directive	EN IEC 60079-0:2018 EN 60079-1:2014 EN 60079-11:2012
2014/30/EU	EMC Directive	EN 50270:2015/AC:2016-08
2011/65/EU ^[1]	RoHS Directive	EN IEC 63000:2018

^[1]Including substances added by Commission Delegated Directive (EU) 2015/863

EU-Type examination Certificate No. DNV 22 ATEX 05201X

Notified Body for ATEX DNV Product Assurance AS (NB 2460)
Veritasveien 1
1363 Høvik
Norway

Auditing Organization for ATEX DNV Product Assurance AS (NB 2460)
Veritasveien 1
1363 Høvik
Norway

The marking of the product shall include the following:

 II 1 G Ex da ia IIC T4 Ga -20°C≤Ta≤+60°C
 II 1 G Ex ia IIC T4 Ga -20°C≤Ta≤+60°C
 Alternative Marking: da ia: including flammable gas sensor.
 ia: not including flammable gas sensor.

Place: Tokyo, Japan

Date: Sep. 7, 2022

Takakura Toshiyuki
General manager
Quality Control Center



UK-Declaration of Conformity

Document No.: 320UK22079



We, RIKEN KEIKI Co., Ltd. 2-7-6, Azusawa, Itabashi-ku, Tokyo, 174-8744, Japan declare under our sole responsibility that the following product conforms to all the relevant provisions.

Product Name: Portable gas detector
Model: GX-Force

Regulations	UK designated Standards
The Equipment and Protective Systems Intended for Use in Potentially Explosive Atmospheres Regulations 2016 (S.I. 2016/1107) (UKEX)	BS EN IEC 60079-0:2018 BS EN 60079-1:2014 BS EN 60079-11:2012
Electromagnetic Compatibility Regulations 2016 (S.I. 2016/1091)	BS EN 50270:2015/AC:2016-08
The Restriction of the Use of Certain Hazardous Substances in Electrical and Electronic Equipment Regulations 2012 (S.I. 2012/3032)	BS EN IEC 63000:2018

UK-Type examination Certificate No. DNV 22 UKEX 55041X

Approved Body for UKEX DNV Business Assurance UK Ltd (AB8501)
4th Floor Vivo Building, 30 Stamford Street,
London SE1 9LQ, United Kingdom

Auditing Organization for UKEX DNV Business Assurance UK Ltd (AB8501)
4th Floor Vivo Building, 30 Stamford Street,
London SE1 9LQ, United Kingdom

The marking of the product shall include the following:

 II 1 G Ex da ia IIC T4 Ga -20°C≤Ta≤+60°C
 II 1 G Ex ia IIC T4 Ga -20°C≤Ta≤+60°C
 Alternative Marking: da ia: including flammable gas sensor.
 ia: not including flammable gas sensor.

Place: Tokyo, Japan

Date: Dec. 9, 2022

Takakura Toshiyuki
General manager
Quality Control Center

Safety Information

Observe the following points to ensure performance as an explosion-proof product:

Product overview

- The GX-Force can be equipped with up to three types of sensors to detect up to four different gas types.
- The GX-Force can be used to detect combustible gases (%LEL), oxygen (O₂), hydrogen sulfide (H₂S), and carbon monoxide (CO).
- Measurement results are displayed on the LCD. Gas alarms are indicated by LEDs and the buzzer based on the settings.

Power source

- The GX-Force is powered by an internal rechargeable lithium ion battery. (The rechargeable battery cannot be replaced by the customer.)
- Charge the battery using the dedicated AC adapter, an IEC 60950 certified SELV power supply, or IEC 62368-1 certified ES1 power supply.
- Make sure that the maximum voltage from the charger does not exceed 6.0 V DC.

<ATEX/UKEX/IECEx specifications>

Explosion-proof construction Intrinsically safe explosion-proof construction, flame-proof enclosure

Explosion-proof class Ex da ia IIC T4 Ga



II 1 G Ex da ia IIC T4 Ga

Ambient temperature -20 °C - +60 °C

Ambient temperature (when charging) +10 °C - +40 °C

Electrical specifications

- BP-Force is specified for the rechargeable lithium ion battery.
- Uses one Panasonic NCR18650GA.
- Charge the battery using the dedicated AC adapter, an IEC 60950 certified SELV power supply, or IEC 62368-1 certified ES1 power supply.

Make sure that the maximum voltage from the charger does not exceed 6.0 V DC.

Certificate numbers

- IECEx: IECEx DNV 22.0029X
- ATEX: DNV 22 ATEX 05201X
- UK Type Examination Certificate: DNV 22 UKEX 55041X

Applicable standards

• IEC 60079-0:2017	• EN IEC 60079-0:2018	• BS EN IEC 60079-0:2018
• IEC 60079-1:2014-06	• EN 60079-1:2014	• BS EN 60079-1:2014
• IEC 60079-11:2011	• EN 60079-11:2012	• BS EN 60079-11:2012



WARNING

- Do not disassemble or modify the product.
- Only the NCR-6309 combustible gas sensor has a flame-proof construction in the product.
- The product is an explosion-proof device. Do not disassemble or modify components other than those stipulated.
- The product incorporates a flame-proof construction sensor. Explosion-proof performance may be impaired if it has not been assembled as specified. When replacing the filter, mount the specified parts using the correct torque.

- If the casing is damaged, stop using the product. Have it repaired before resuming use.
 - Do not use the product with the sensors inadequately shielded or exposed to ultraviolet light.
 - Do not charge in hazardous areas.
 - Charge the battery using the dedicated AC adapter, an IEC 60950 certified SELV power supply, or IEC 62368-1 certified ES1 power supply.
-

Product code

INST. No.	<u>00</u>	<u>0</u>	<u>000</u>	<u>0000</u>	<u>00</u>
	A	B	C	D	E

A: Year of manufacture (0 - 9)

B: Month of manufacture (1 - 9 for Jan. - Sep.; XYZ for Oct., Nov., Dec.)

C: Manufacturing lot

D: Serial number

E: Factory code