



EXO User Manual

ADVANCED WATER QUALITY MONITORING PLATFORM



a xylem brand



The information contained in this manual is subject to change without notice.

Effort has been made to make the information in this manual complete, accurate, and current.

The manufacturer shall not be held responsible for errors or omissions in this manual.

Consult YSI.com/EXO for the most up-to-date version of this manual.

THIS IS AN INTERACTIVE DOCUMENT



When viewing this document as an Adobe™ PDF, hovering your cursor over certain phrases will bring up the finger-point icon. Clicking elements of the Table of Contents, website URLs, or references to certain sections will take you automatically to those locations.

Product Components

Carefully unpack the instrument and accessories and inspect for damage. If any parts or materials are damaged, contact YSI Customer Service at 800-897-4151 (+1 937 767-7241) or the authorized YSI distributor from whom the instrument was purchased.

Technical Support

Telephone: 800 897 4151 (USA), +1 937 767 7241 (Globally)

Monday through Friday, 8:00 AM to 5:00 ET

Fax: +1 937 767 9353 (orders)

Email: info@ysi.com

YSI.com

Safety Information

Please read this entire manual before unpacking, setting up or operating this equipment. Pay attention to all precautionary statements. Failure to do so could result in serious injury to the operator or damage to the equipment. Make sure that the protection provided by this equipment is not impaired. Do not use or install this equipment in any manner other than that specified in this manual.

Precautionary Symbols

NOTE: Information that requires special emphasis

NOTICE: Indicates a situation which, if not avoided, may cause damage to the instrument

 **CAUTION:** Indicates a potentially hazardous situation that may result in minor or moderate injury

 **WARNING:** Indicates a potentially hazardous situation which could result in death or serious injury

TABLE OF CONTENTS

1. EXO Platform Overview

- 1.1 EXO1 Sonde Overview
- 1.2 EXO2 Sonde Overview
- 1.3 EXO2^S Sonde Overview
- 1.4 EXO3 Sonde Overview
- 1.5 EXO Field Cables Overview
- 1.6 EXO Handheld Overview
- 1.7 EXO GO Overview

2. Operation

- 2.1 Sonde Install / Replace EXO1 Batteries
- 2.2 Sonde Install / Replace EXO2 and EXO3 Batteries
- 2.3 Install / Remove Guard or Cal. Cup
- 2.4 Install / Remove Sensors
- 2.5 Sonde States and LED Descriptions
- 2.6 Connection Methods Overview
- 2.7 Awaken Sonde, Activate *Bluetooth*
- 2.8 Connect Sonde, *Bluetooth*
- 2.9 Connect Sonde, SDI-12 - EXO3 Only
- 2.10 Communication Adapters Overview
- 2.11 Communication Adapters, USB
- 2.12 Communication Adapters, DCP
- 2.13 Communication Adapter, RS-232
- 2.14 Communication Adapters, SDI-12
- 2.15 Communication Adapters, Modbus
- 2.16 Connect Sonde, Flow Cell
- 2.17 Daisy Chaining, Sonde Expansion
- 2.18 Sonde Clamping / Mooring, Long-Term Monitoring

3. KorEXO Software

- 3.1 Introduction
- 3.2 Installation
- 3.3 Instrument Connection Panel
- 3.4 Home Screen
- 3.5 File Menu
- 3.6 Calibration Screen
- 3.7 Deployment Screen
- 3.8 Live & Recorded Data
- 3.9 Instruments and Sensors

4. Sensors and Calibration

- 4.1 Sensors Overview
- 4.2 Calibration Basic Overview
- 4.3 Calibration Report
- 4.4 SmartQC Overview
- 4.5 Conductivity / Temperature Sensor Overview
- 4.6 Conductivity / Temperature Calibration
- 4.7 Wiped Conductivity / Temperature Sensor Overview
- 4.8 Wiped C / T Calibration and Deployment
- 4.9 Depth and Level Sensor Overview
- 4.10 Depth and Level Calibration
- 4.11 Dissolved Oxygen Sensor Overview
- 4.12 Dissolved Oxygen Calibration
- 4.13 fDOM Sensor Overview
- 4.14 fDOM Calibration Standards
- 4.15 fDOM Calibration

- 4.16 ISEs: Ammonium, Nitrate, & Chloride Overview
- 4.17 ISEs: Ammonium, Nitrate, & Chloride Calibration
- 4.18 pH and ORP Sensor Overview
- 4.19 pH Calibration
- 4.20 ORP Calibration
- 4.21 Rhodamine Sensor Overview
- 4.22 Rhodamine Calibration
- 4.23 Total Algae Sensor Overview
- 4.24 Total Algae Calibration
- 4.25 Turbidity Sensor Overview
- 4.26 Turbidity Calibration
- 4.27 Total Suspended Solids Calculation

5. Maintenance

- 5.1 Sonde Storage
- 5.2 Sonde Maintenance
- 5.3 Replace EXO1 Sonde Bail
- 5.4 Replace EXO2 and EXO3 Sonde Bail
- 5.5 Depth and Level Sensor Maintenance and Storage
- 5.6 Standard Optical Sensors Maintenance and Storage
- 5.7 C/T Sensor Maintenance and Storage
- 5.8 Dissolved Oxygen Sensor Storage
- 5.9 Dissolved Oxygen Sensor Maintenance and Rehydration
- 5.10 Dissolved Oxygen Sensor Cap Replacement
- 5.11 pH and pH/ORP Sensors Storage and Rehydration
- 5.12 pH and pH/ORP Sensors Maintenance
- 5.13 ISE Sensors Maintenance and Storage
- 5.14 Sensor Module Replacement
- 5.15 EXO Central Wiper Maintenance and Storage
- 5.16 EXO Field Cable Maintenance and Storage
- 5.17 Connectors Maintenance and Storage
- 5.18 Antifouling Equipment Maintenance
- 5.19 Flow Cell Maintenance
- 5.20 Storage Cases, Packing Options

6. Vented Level Sonde

- 6.1 Vented Level Sonde Overview
- 6.2 Vented Level Sonde Installation
- 6.3 Vented Cables and Desiccants Installation
- 6.4 Calibration
- 6.5 Maintenance and Storage

7. Accessories

- 7.1 Ordering

8. Health and Safety, Warranty, Service

- 8.1 Health and Safety, Chemicals
- 8.2 Radio Frequency
- 8.3 Declarations of Conformity
- 8.4 Instrument Warranty
- 8.5 Instrument Service, Cleaning and Packing
- 8.6 Instrument Service, Recycling

9. Appendices

- 9.1 EXO PAR User Manual
- 9.2 EXO Handheld Mini Manual



Section 1

EXO Platform Overview

1.1

EXO1 Sonde Overview

The EXO1 sonde is a multiparameter instrument that collects water quality data. The sonde collects the data with up to four user-replaceable sensors and an integral pressure transducer. Each sensor measures its parameter via a variety of electrochemical, optical, or physical detection methods. Each port accepts any EXO sensor and automatically recognizes its type. Depending upon user-defined settings, the EXO1 will collect data and store it onboard the sonde, transfer the data to a data collection platform (DCP), or relay data directly to a user's PC or the EXO Handheld. See [Section 6](#) for information specific to vented level sondes.

Users communicate with the sonde via a field cable to an EXO Handheld, **Bluetooth**® wireless connection to a PC or EXO Classic Handheld, or a USB connection (via communications adapter) to a PC.

Specifications

Operating Environment <i>Depth Rating</i>	250 meters, 820 feet
Material	Xenoy®, Lexan®, titanium, 316 stainless steel
Internal Logging Memory Capacity	512 MB
Software	KorEXO Software
Communications Sonde	Wireless: <i>Bluetooth</i> Field Cable: RS-485
<i>Adapters</i>	RS-232, Mod Bus, USB, SDI-12
Power <i>External</i> <i>Internal</i>	9-16 VDC (2) D-cell batteries
Temperature <i>Operating</i> <i>Storage</i>	-5 to 50°C -20 to +80°C
Battery Life	90 days*
Dimensions <i>Diameter</i> <i>Length</i> <i>Weight w/ battery</i>	4.70 cm, 1.85 in 64.77 cm, 25.50 in 1.42 kg, 3.15 lb

*Battery life will depend on the type of sensors and measurement frequency.

EXO1 Bulkhead

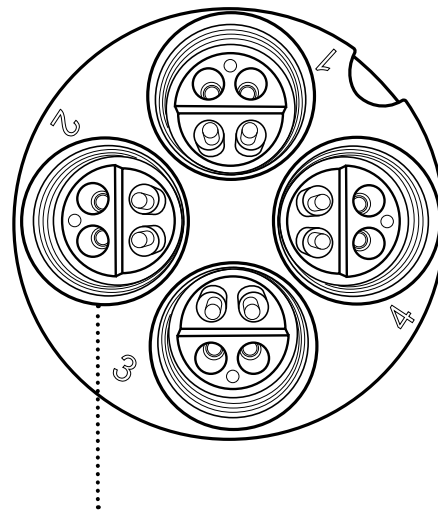

Universal Sensor Ports



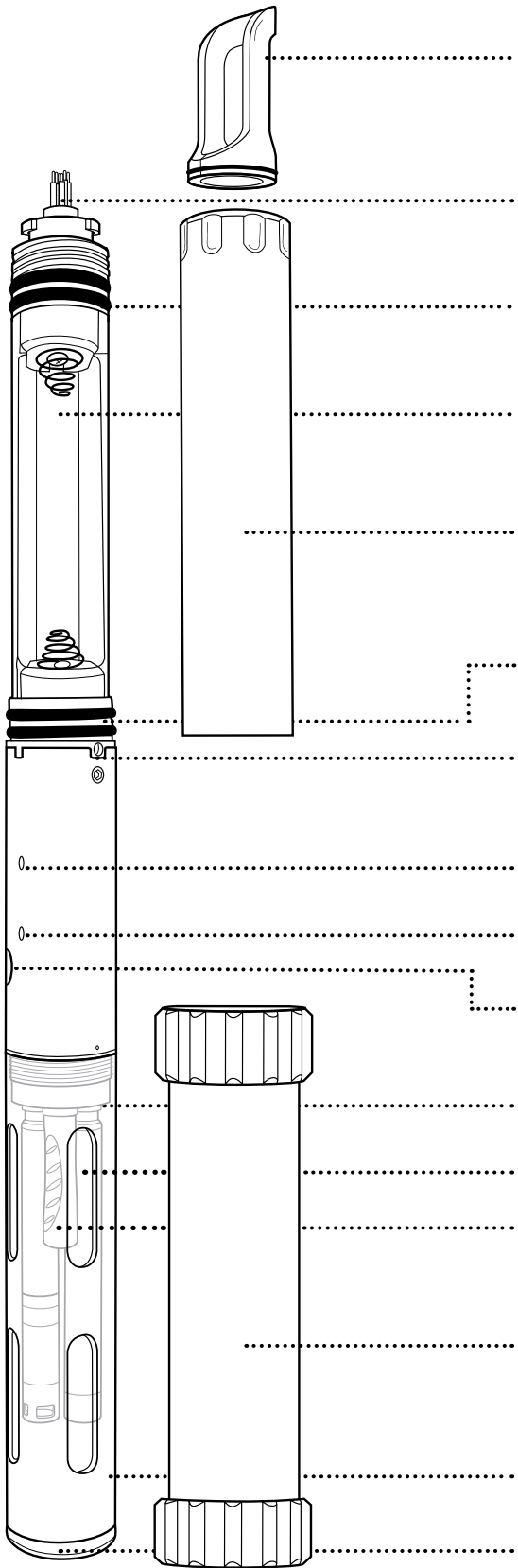

- EXO1 Sonde**
599501-xx
- Removable Bail**
599473
- 6-Pin Cable Connector**
- Upper Battery Compartment Seal**
O-ring kit 599680
- Battery Compartment**
- Battery Cover**
599052
- Lower Battery Compartment Seal**
- Pressure Transducer Opening**
- Red LED Indicator - Sonde Status**
- Blue LED Indicator - Bluetooth**
- On/Off Magnetic Switch for Power and Bluetooth**
- Bulkhead**
- Sensors**
- Port Plug**
599475
- Calibration Cup**
599786
- Sensor Guard**
599666, 599563
- Guard Weight**
599471

1.2

EXO2 Sonde Overview

The EXO2 sonde is a multiparameter instrument that collects water quality data. The sonde collects the data with up to seven user-replaceable sensors and an integral pressure transducer. Each sensor measures its parameter via a variety of electrochemical, optical, or physical detection methods. Each port accepts any EXO sensor and automatically recognizes the type of sensor. Depending on user-defined settings, the EXO2 will collect data and store it onboard the sonde, transfer the data to a data collection platform (DCP), or relay it to a user's PC or EXO Handheld via cable, USB connection, or **Bluetooth®** connection.

In addition to six standard sensor ports, the central port (port 7) can accept either a central wiper or an additional sensor. The auxiliary port on top of the sonde will allow the user to connect the EXO2 to other EXO sondes, making this our most expandable and flexible sonde. See [Section 6](#) for information specific to vented level sondes.

Users communicate with the sonde via a field cable to an EXO Handheld, *Bluetooth* wireless connection to a PC or EXO Classic Handheld, or a USB connection (via communications adapter) to a PC. See [Section 2.6](#) for a communication overview.

Specifications

Operating Environment	
<i>Depth Rating</i>	250 meters, 820 feet
Material	Xenoy®, Lexan®, titanium, 316 stainless steel
Internal Logging Memory Capacity	512 MB
Software	KorEXO Software
Communications Sonde	Wireless: <i>Bluetooth</i> Field Cable: RS-485
<i>Adapters</i>	RS-232, Mod Bus, USB, SDI-12
Power	
<i>External</i>	9-16 VDC
<i>Internal</i>	(4) D-cell batteries
Temperature	
<i>Operating</i>	-5 to +50°C
<i>Storage</i>	-20 to +80°C
Battery Life	90 days*
Dimensions	
<i>Diameter</i>	7.62 cm, 3.00 in
<i>Length</i>	71.1 cm, 28.00 in
<i>Weight w/ battery</i>	3.60 kg, 7.90 lb

EXO2 Bulkhead

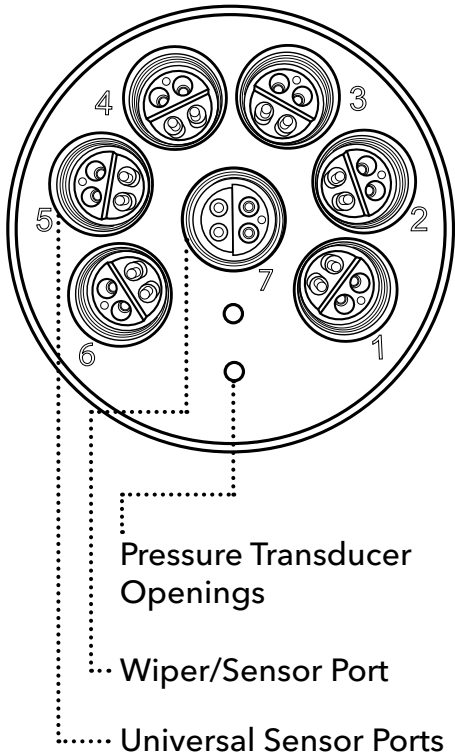

*Battery life will depend on the type of sensors and measurement frequency.



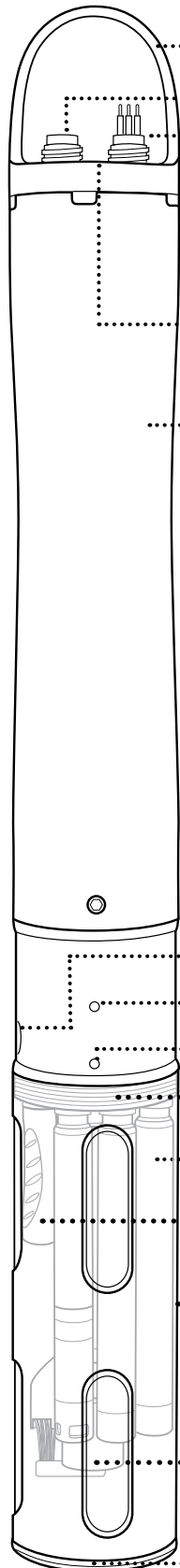

EXO2 Sonde

599502-xx

Removable Bail

599474

Auxiliary Port

6-Pin Cable Connector

Battery Cap/Pressure Relief Valve

O-ring kit 599681

Battery Compartment Opening

Battery Compartment

On/Off Magnetic Switch for Power and Bluetooth

Red LED Indicator - Sonde Status

Blue LED Indicator - Bluetooth

Bulkhead

Sensors

Port Plug

599475

Sensor Guard

599667, 599564

Calibration Cup

599316

Central Wiper

599090-01

Guard Weight

599472

1.3

EXO2^s Sonde Overview

The EXO2^s sonde is compact, battery-less, factory-customized version of the EXO2 sonde for use where external power is available. One orders an EXO2^s by first selecting the appropriate depth of an EXO2 sonde (599502-xx) and a conversion kit (119077) that is used by our team to convert the EXO2 sonde into an EXO2^s. The sonde supports up to seven user-replaceable sensors and an integral pressure transducer. The EXO2^s features the same logging and communication options as the standard EXO2; however, an external power source is required. Power can be supplied via a DCP, the EXO handheld or EXO GO. See [Section 2.6](#) for a communication overview.

Specifications

Operating Environment <i>Depth Rating</i>	250 meters, 820 feet
Material	Xenoy*, Lexan*, titanium, 316 stainless steel
Internal Logging Memory Capacity	512 MB
Software	KorEXO Software
Communications Sonde	Wireless: Bluetooth Field Cable: RS-485
Adapters	RS-232, Mod Bus, USB, SDI-12
Power External	9-16 VDC
Temperature <i>Operating</i> <i>Storage</i>	-5 to +50°C -20 to +80°C
Dimensions <i>Diameter</i> <i>Length</i>	7.62 cm, 3.00 in 47.0 cm, 18.50 in

EXO2^s Bulkhead

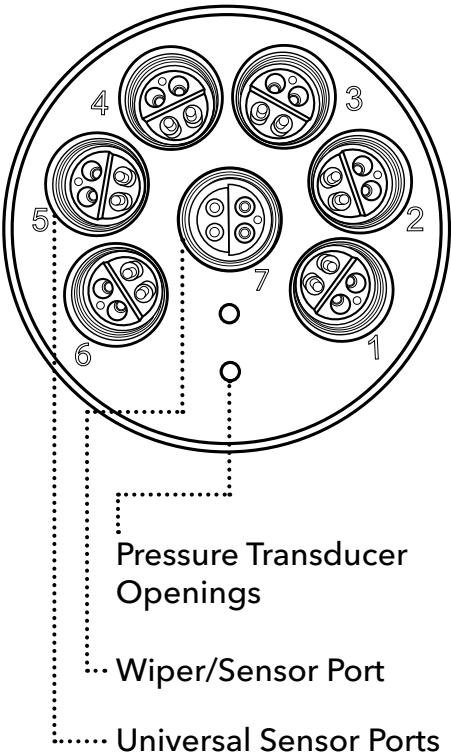

EXO2^S Sonde
 599502-xx and 119077

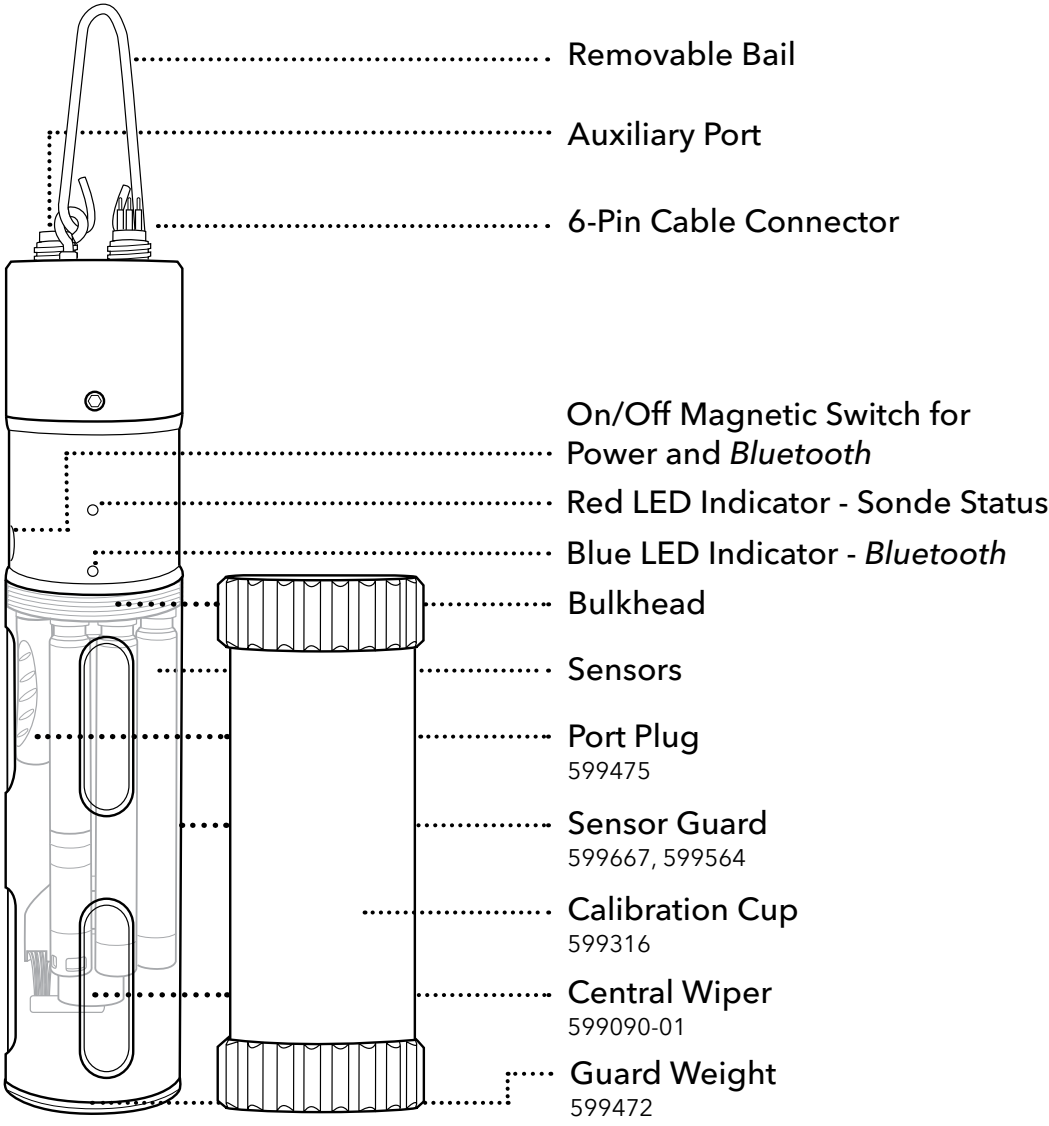

1.4

EXO3 Sonde Overview

The EXO3 sonde is a multiparameter instrument that collects water quality data. The sonde collects the data with up to four user-replaceable sensors and an integral pressure transducer. The EXO3 also has a central port for an EXO wiper (or an additional sensor). Each sensor measures its parameter via a variety of electrochemical, optical, or physical detection methods. Each port accepts any EXO sensor and automatically recognizes the type of sensor. Depending on user-defined settings, the EXO3 will collect data and store it onboard the sonde, transfer the data to a data collection platform (DCP), or relay it to a user's PC or EXO Handheld via cable, USB connection, or **Bluetooth®** connection.

Users communicate with the sonde via a field cable to an EXO Handheld, *Bluetooth* wireless connection to a PC or a USB connection (via communications adapter) to a PC. See [Section 2.6](#) for a communication overview.

NOTE: The EXO3 Sonde includes integral SDI-12 communications for use with cables up to 100 meters in length. With EXO3, a 599820 Signal Output Adapter (SOA) is not necessarily required. See [Section 2.9](#) for details.

Specifications

Operating Environment	
<i>Depth Rating</i>	250 meters, 820 feet
Material	Xenoy®, Lexan®, titanium, 316 stainless steel
Internal Logging Memory Capacity	512 MB
Software	KorEXO Software
Communications Sonde	Wireless: <i>Bluetooth</i> Field Cable: RS-485, SDI-12
<i>Adapters</i>	RS-232, Mod Bus, USB, SDI-12
Power	
<i>External</i>	9-16 VDC
<i>Internal</i>	(2) D-cell batteries
Temperature	
<i>Operating</i>	-5 to +50°C
<i>Storage</i>	-20 to +80°C
Battery Life	60 days*
Dimensions	
<i>Diameter</i>	7.62 cm, 3.00 in
<i>Length</i>	58.67 cm, 23.1 in
<i>Weight w/ battery</i>	2.0 kg, 4.41 lb

EXO3 Bulkhead

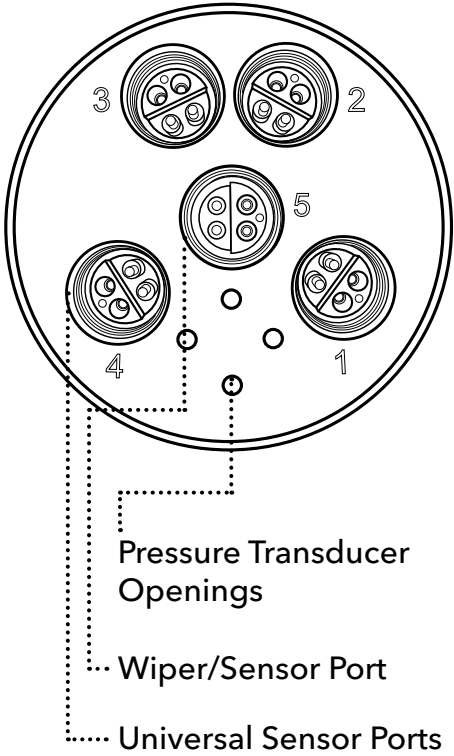

*Battery life will depend on the type of sensors and measurement frequency.



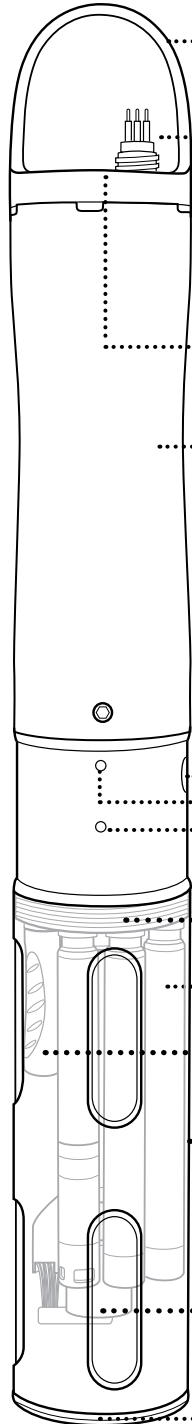

EXO3 Sondé

599503-xx

Removable Bail

599474

6-Pin Cable Connector



Battery Cap/Pressure Relief Valve

O-ring kit 599681

Battery Compartment Opening

Battery Compartment

On/Off Magnetic Switch for Power and Bluetooth

Red LED Indicator - Sondé Status

Blue LED Indicator - Bluetooth

Bulkhead

Sensors

Port Plug

599475

Sensor Guard

599667, 599564

Calibration Cup

599316

Central Wiper

599090-01

Guard Weight

599472

1.5

EXO Field Cables

Overview

The EXO rugged field cable comes in many different lengths and options to meet the needs of your specific application. Selecting the correct cable length and coupler will ensure the best quality data for your project. For a full list of cable options and precautions for extended cables, please see [Cable Options](#) on the following page.

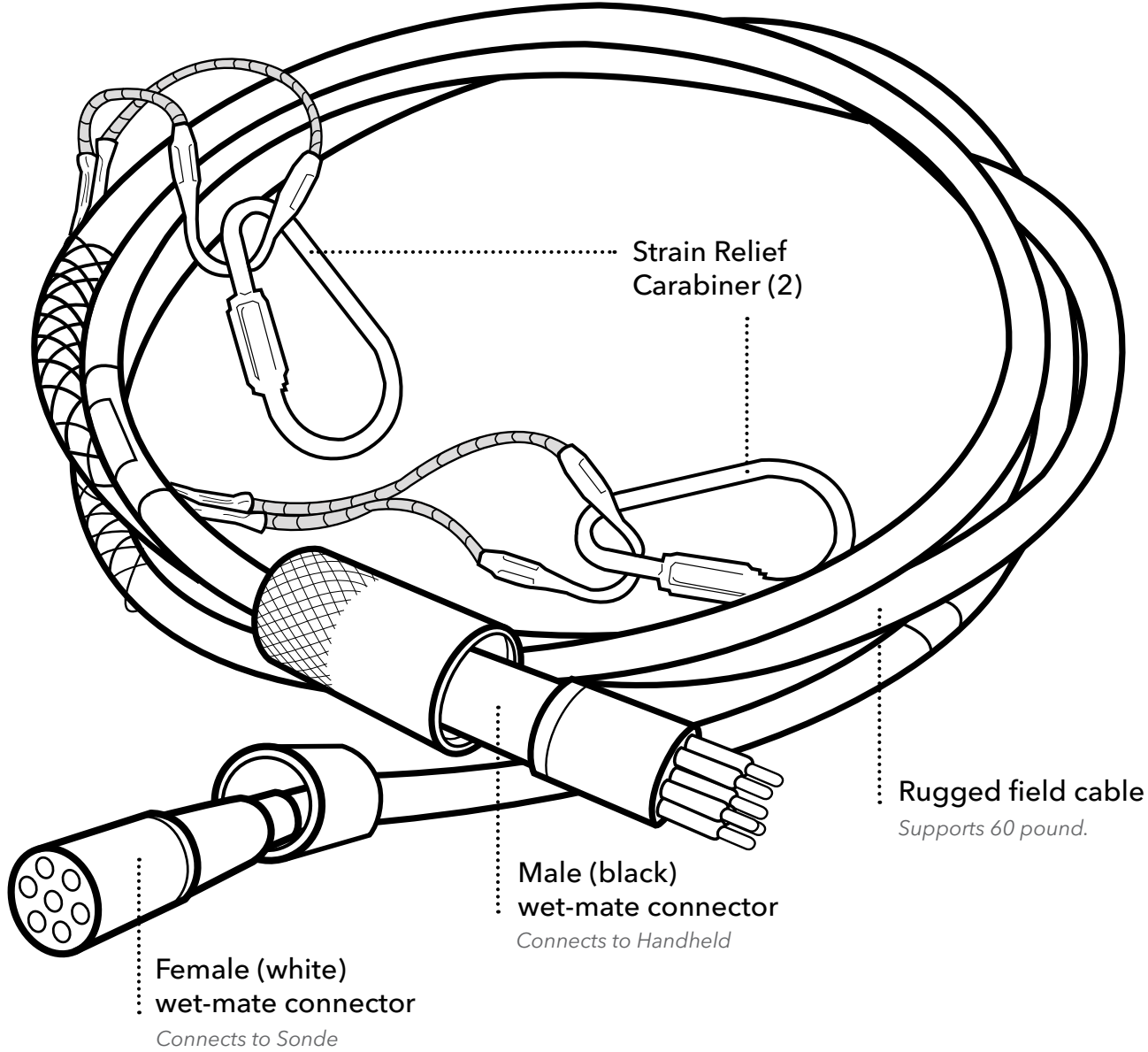

Flying Lead Cable Vented and Non-Vented

A flying lead cable option is available which is intended for wiring to a data collection platform (DCP) or a data logger. A vented flying lead option is for use with a vented sonde only. See [Section 6](#) for more information.

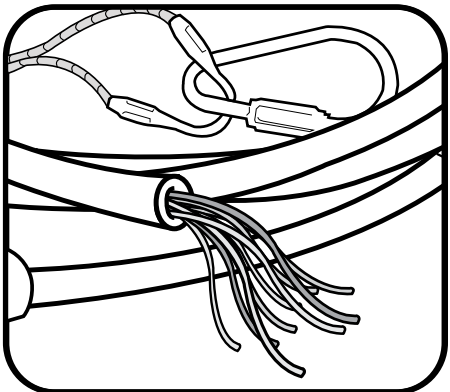

Cable Options

599431-01	EXO Cable Coupler, Titanium	599040-250	EXO 250 meter Field Cable
599431-02	EXO Cable Coupler, Brass	599040-300	EXO 300 meter Field Cable
599040-2	EXO 2 meter Field Cable	599008-10	EXO 10 meter Flying Lead Cable
599040-4	EXO 4 meter Field Cable	599008-15	EXO 15 meter Flying Lead Cable
599040-10	EXO 10 meter Field Cable	599008-33	EXO 33 meter Flying Lead Cable
599040-15	EXO 15 meter Field Cable	599008-66	EXO 66 meter Flying Lead Cable
599040-33	EXO 33 meter Field Cable	599008-100	EXO 100 meter Flying Lead Cable
599040-66	EXO 66 meter Field Cable	599210-4	EXO 4 meter VENTED Flying Lead Cable
599040-100	EXO 100 meter Field Cable	599210-10	EXO 10 meter VENTED Flying Lead Cable
599040-150	EXO 150 meter Field Cable	599210-15	EXO 15 meter VENTED Flying lead Cable
599040-200	EXO 200 meter Field Cable	599210-33	EXO 33 meter VENTED Flying Lead Cable

Extended Field Cables Precaution

There are some limitations for applications using EXO cable lengths greater than 100 meters - whether by extended cables, or by means of cable-coupling.

NOTICE: To prevent system problems related to power and signal integrity, make sure you understand the system limitations if you plan to use cable couplers or extended cables.

Voltage drop through long cables can adversely affect the available power at the sonde.

Here are some techniques to prevent such problems:

- Use Alkaline or high-capacity NiMH batteries in the sonde. This serves a dual purpose of adding weight in the sonde for profiling applications, as well as preventing system reboots during period of high current demand.
- Do not use EXO's USB SOA or Handheld as the sole power source for systems with large payloads (many optical or high power sensors). These devices do not provide a voltage high enough for use with extended cables.
- Limit use of EXO's auxiliary port to lower power devices.
- Power the sondes with a regulated power supply (12V-14V) capable of supplying 1A. This will ensure sufficient power is reaching the sonde.

1.6

EXO Handheld Overview

The EXO Handheld is a rugged, microcomputer-based instrument that allows the user to display sonde readings, configure sondes, store and retrieve data, and transfer data from sondes to a computer. Equipped with GPS and an integrated barometer, the Handheld communicates via field cable or USB connector.

The unit also utilizes an adjustable backlit screen for easy day or night viewing. The handheld features a built-in rechargeable Lithium-Ion battery, integrated help menus, a simplified user interface, and a more ergonomic design than the Classic handheld.

NOTE: For operating instructions, please see the [EXO Handheld Mini-Manual](#).

Specifications

GPS Accuracy	Yes 2.5 m CEP (dependent on site conditions)
Display	IP-67 rated, Color-LCD graphic display
Memory	>100,000 data sets
Software	KorEXO Software
Communications	Field Cable, USB
Power Internal	Rechargeable Lithium-Ion Pack
Operating Time	> 15 hours
Charging Time	9 hours (from 0 to 100%)
Temperature Operating	0°C to 50°C
Storage	0°C to 60°C (no battery) 0°C to 45°C (battery installed)
Barometer Range	Built-in with User Calibration 375 to 825 mmHg
Accuracy	±1.5 mmHg from 0 to 50°C
Resolution	0.1 mmHg
Dimensions	
Width	8.3 cm, 3.27 in
Length	21.6 cm, 8.5 in
Depth	5.6 cm, 2.21 in
Weight w/ battery	0.57 kg, 1.25 lb

NOTE: Barometer vent located under battery cover.

EXO Handheld

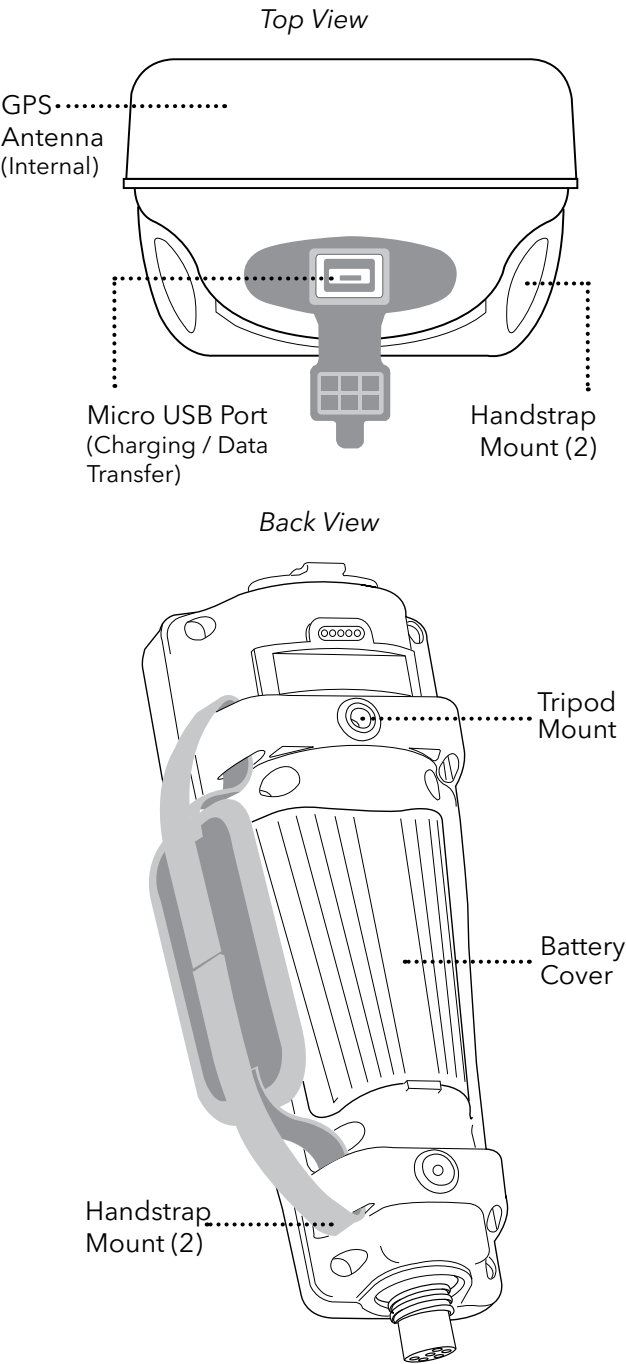

EXO Handheld

599960

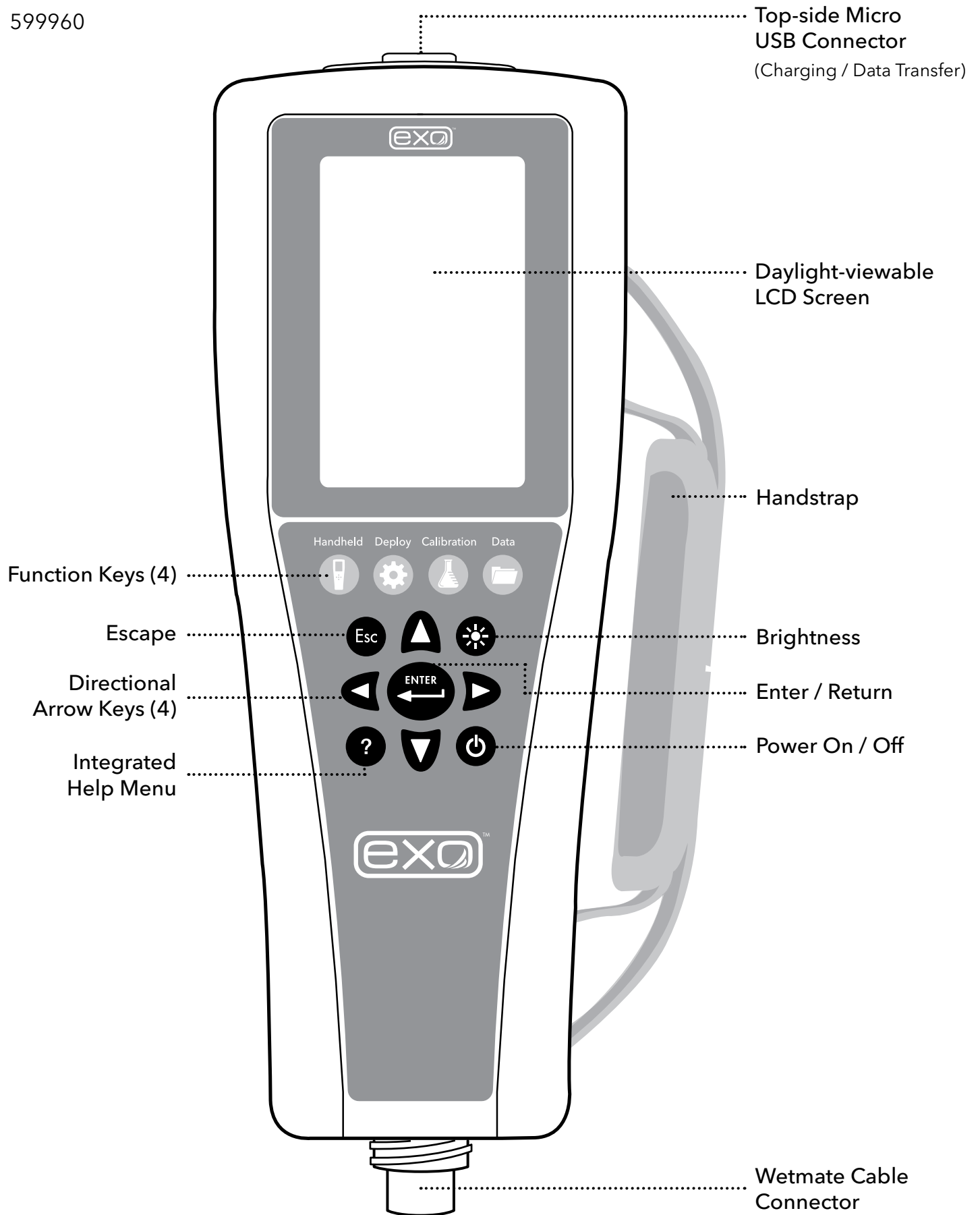

1.7

EXO GO Overview

The EXO GO is a compact, rugged device that enables **Bluetooth®** communication between a submerged EXO sonde and a device running KorEXO Software. The EXO GO remains topside while connected to a sonde via the field cable. Pair with a tablet or laptop running KorEXO to form a complete sampling system.

With an integral barometer and GPS, the EXO GO provides barometric pressure and location data in addition to the connected sonde data. The built-in, rechargeable Lithium-Ion battery will power an EXO Sonde for a full day of sampling. LED indicators represent battery level, charge status, and *Bluetooth* status, as shown in the diagram below.

NOTE: EXO GO is not compatible with earlier versions of KorEXO Software (prior to 2.0).

LED Descriptions

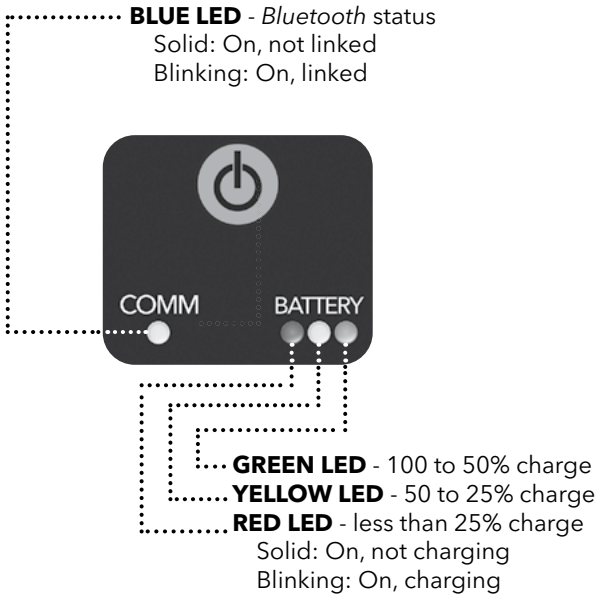

Specifications

Communications	<i>Bluetooth, USB 2.0</i>
Bluetooth	Class 2
<i>Range</i>	10 m
Barometer	<i>Built-in with User Calibration</i>
<i>Range</i>	375 to 825 mmHg
<i>Accuracy</i>	±1.5 mmHg
<i>Resolution</i>	0.1 mmHg
GPS	
<i>Accuracy</i>	2.5 m CEP (dependent on site conditions)
Battery	Rechargeable Lithium-Ion
<i>Operating Time</i>	> 15 hours (powering full EXO3)
<i>Charge Time</i>	9 hours (from 0 to 100%)
Enclosure	Xenoy
<i>Rating</i>	IP-67
Temperature	
<i>Operating</i>	-5 to 50°C
<i>Storage</i>	0 to 45°C
Dimensions	
<i>Width</i>	5.2 cm
<i>Length</i>	17.4 cm
<i>Depth</i>	3.5 cm
<i>Weight</i>	240 g

EXO GO

577400

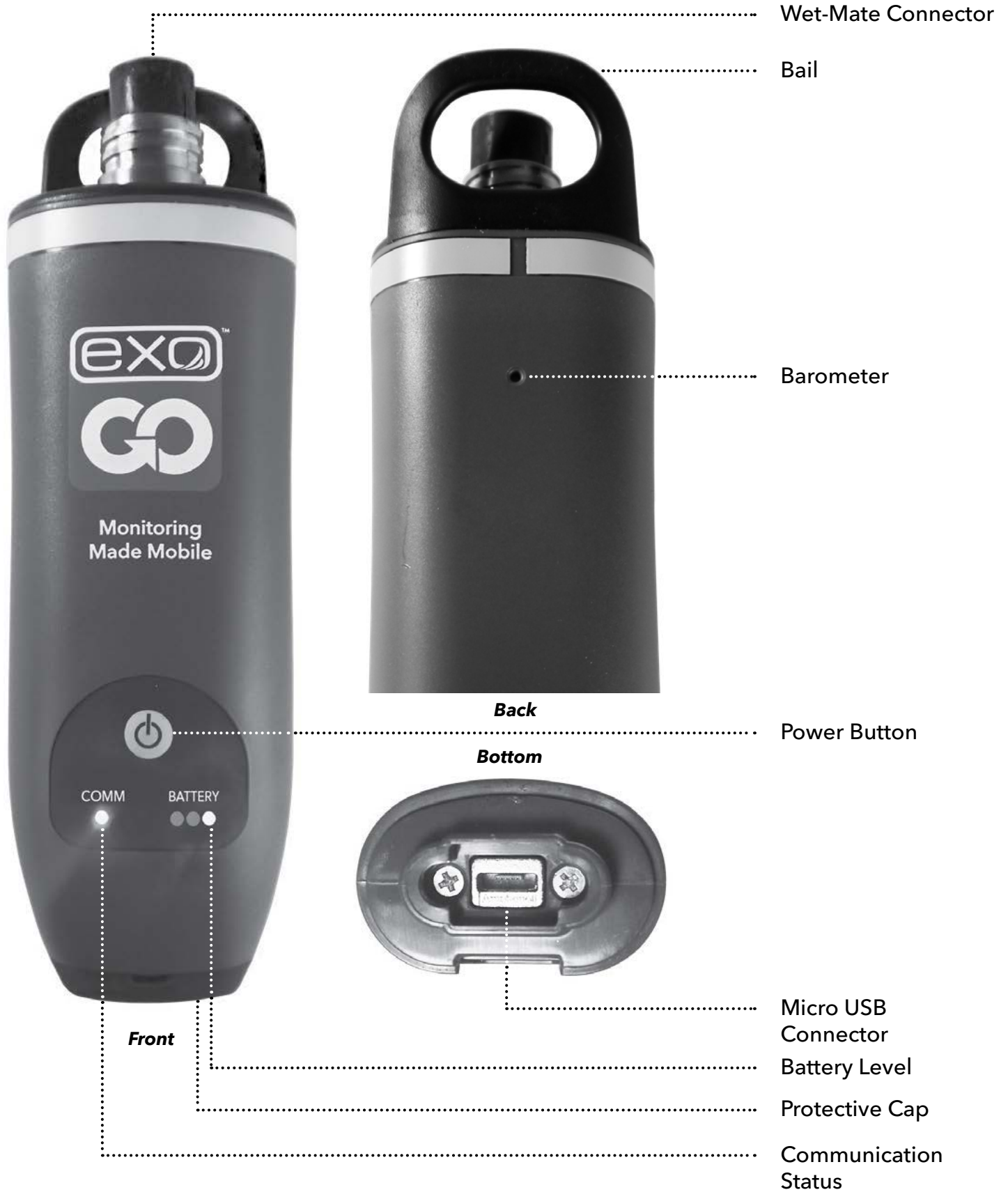



Section 2

Operation

2.1

Sonde

Install / Replace EXO1 Batteries

EXO1 water quality sondes use two (2) D-cell batteries as a power source. Using alkaline batteries, users can expect approximately 90 days of deployment from a fully loaded sonde that samples once every 15 minutes. However, deployment times may vary greatly depending on water temperature, sampling rate, sensor payload, and brand of battery.

See [Battery Life Specification](#) on the next page.

NOTICE: Do not use Ni-Cad or 3.6V Lithium batteries in the EXO1 sonde.

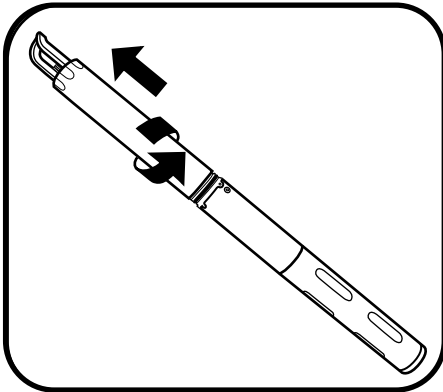

1 Remove battery cover

Start with a clean and dry sonde. Hold the sonde horizontally with the bail up and twist the battery cover counterclockwise until free. If necessary, slide the sonde tool's larger opening over the end of the battery compartment and use it as a lever to break the compartment free. Then slide off the battery cover.

NOTICE:

Do not remove the screws on the sonde.

Do not clamp the sonde in a vise.

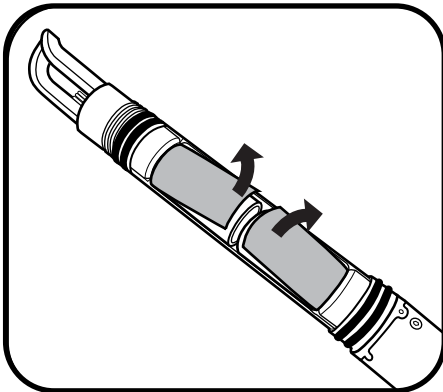

2 Remove old batteries

Expose the batteries by flipping the isolation flap up away from the batteries, and pull the batteries free of their compartment. Always dispose of used alkaline batteries according to local requirements and regulations.

Clean the inside of the battery compartment with a lint-free cloth.

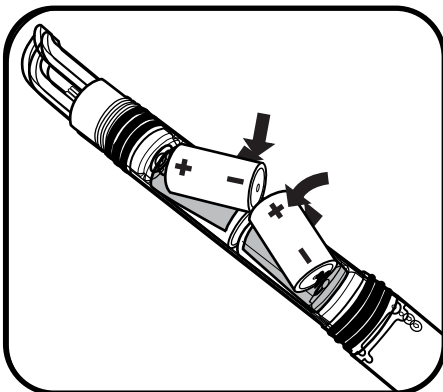

3 Install new batteries

Install the new batteries so that the positive terminals point towards the bail (away from the sensor bulkhead). Replace the isolation flap over the batteries.

NOTICE:

Do not use Ni-Cad or 3.6V Lithium batteries in the sondes.

Damage to the circuit board is not covered under warranty.

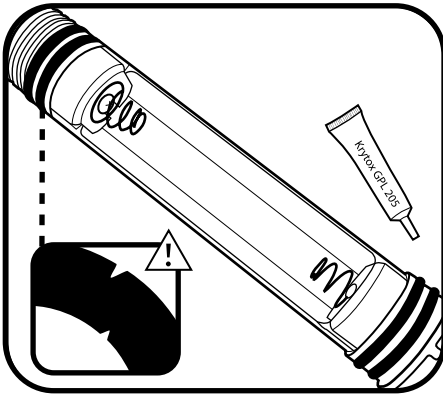

4 Check and service o-rings

NOTE: Before replacing the battery cover, check and service the four o-rings.

Ensure that the o-rings are not nicked or torn and that there are no contaminants or particles on them or the sealing surfaces inside the battery cover. Clean the o-rings with a lint-free cloth. Then apply a thin coat of Krytox® lubricant to each o-ring.

EXO1 replacement o-ring kits are available, part #599680.

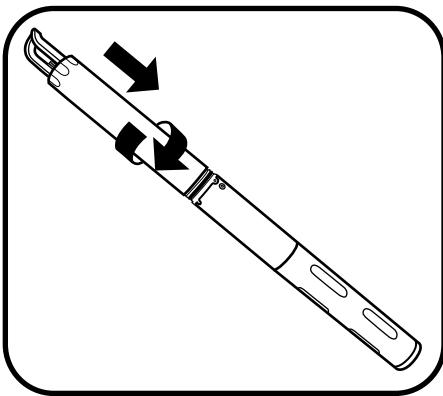

5 Replace battery cover

Twist the battery cover clockwise until it stops at the rubber gasket. The gasket does not provide a seal and does not need to be compressed.

NOTICE: Do not overtighten; overtightening will not create a strong seal and may damage the sonde.

The EXO1 sonde has a resealing pressure relief valve; no maintenance is required.

If a battery failure occurs that results in battery acid leakage into the battery compartment, the sonde must be returned to a service center for evaluation.

Battery Life Specification (Example)

When using alkaline batteries: Estimated battery life is approximately 90 days for EXO1 at 20°C at a 15-minute logging interval, with temperature/conductivity, pH/ORP, Optical DO, and turbidity sensors installed. Battery life is heavily dependent on sensor configuration and is given for a typical sensor ensemble. Battery life is reduced in cold-water applications.

When using rechargeable nickel metal hydride (NiMH) batteries: Estimated battery life is not available because NiMH batteries vary greatly in manufacturer capacity and discharge curves. We recommend a NiMH D-cell battery with a minimum rating of 10,000 milliamp hours that is fully charged each time it is used.

2.2

Sonde

Install / Replace EXO2 and EXO3 Batteries

EXO2 sondes use four (4) D-cell batteries as a power source. Using alkaline batteries, users can expect approximately 90 days of deployment from a fully loaded sonde that samples once every 15 minutes. However, deployment times may vary greatly depending on water temperature, sampling rate, sensor payload, wiper frequency, and brand of battery.

See [Battery Life Specification](#) on the next page.

EXO3 sondes use two (2) D-cell batteries as a power source and can expect 60 days of deployment with an average sensor payload while sampling once every 15 minutes.

NOTICE: Do not use Ni-Cad or 3.6V Lithium batteries in the EXO sondes.

Pressure in Battery Compartment

The EXO2 and EXO3 sondes are equipped with a pressure relief valve to protect against catastrophic battery failure. If the valve is open (indicating an over-pressure situation), the battery cap must be replaced. Significant water leakage into the battery compartment requires that your instrument be evaluated by the manufacturer or Authorized Service Center before the next deployment.

⚠ WARNING: Do not paint over or cover the pressure release valve in any way.
Blocking the pressure release valve can lead to dangerously high internal pressure.

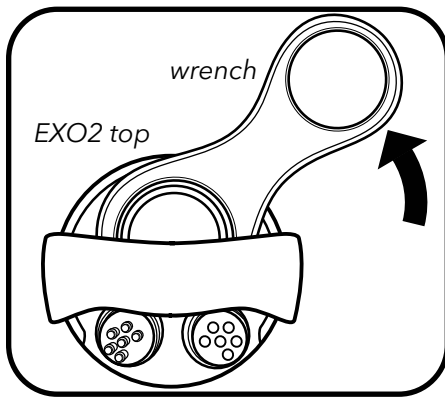

1 Loosen battery cap

Start with a clean and dry sonde. Slide the sonde tool's smaller opening over the battery cap on top of the EXO2 or EXO3. Using the tool as a lever, firmly turn the tool counterclockwise until the battery cap is loose.

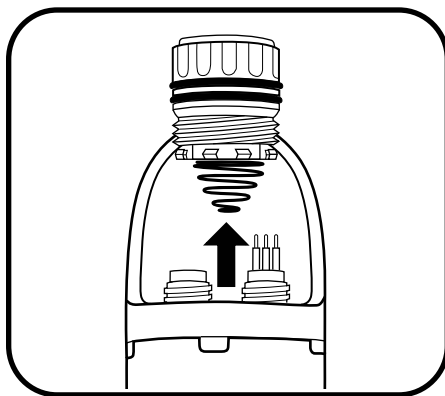

2 Remove battery cap and old batteries

Once the cap is sufficiently loose, remove the cap and old batteries from the well. Always dispose of used alkaline batteries according to local requirements and regulations.

Clean the o-ring sealing surfaces of the cap with a lint-free cloth. Inspect down into the battery tube to make sure it is clean and dry.

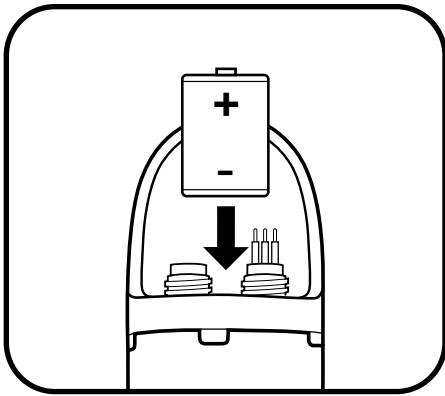

3 Insert new batteries

With the positive terminal facing up, insert four (4) new D-cell batteries into the battery well for EXO2 sondes, or two (2) new D-cell batteries for EXO3 sondes.

NOTICE:

Do not use Ni-Cad or 3.6V Lithium batteries in the sondes.
Damage to the circuit board is not covered under warranty.

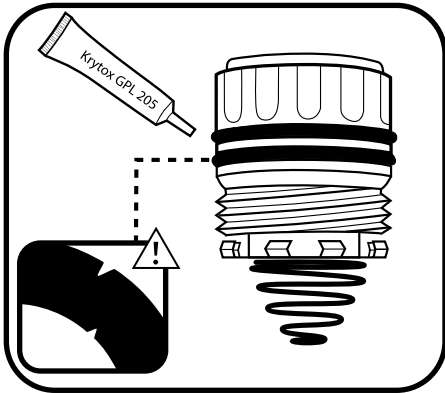

4 Check and service o-rings

NOTE: Before replacing the battery cover, inspect and service the four o-rings.

Ensure that the o-rings are not nicked or torn and that there are no contaminants or particles on the o-rings or the sealing surfaces inside the battery cover. Then apply a thin coat of Krytox® lubricant to each o-ring and sealing surface.

EXO2 replacement o-ring kits are available, part #599681.

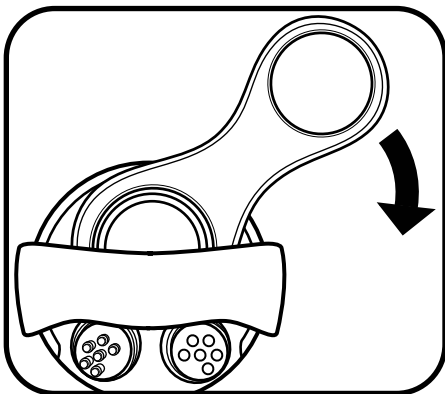

5 Replace battery cap

After servicing the cap's o-rings, insert the cap in its recess. Then, using your thumb, press down on the pressure relief valve while turning the cap clockwise. Once the cap threads are engaged, use the tool to tighten until snug.

NOTICE: Do not overtighten; overtightening will not create a strong seal and may damage the sonde. When completed, the top o-ring of the cap must be below the battery compartment opening.

If a battery failure occurs that results in battery acid leakage into the battery compartment, the sonde must be returned to a service center for evaluation. Some battery acid will damage the plastic in the battery compartment.

Battery Life Specification (Example)

When using alkaline batteries: Estimated battery life is approximately 90 days for EXO2, and 60 days for EXO3, at 20°C with a 15-minute logging interval, with temperature/conductivity, pH/ORP, Optical DO, turbidity, and Total Algae-PC sensors installed along with a central wiper which rotates once every logging interval. Battery life is heavily dependent on sensor configuration and is given for a typical sensor ensemble. Battery life is reduced in cold-water applications.

When using rechargeable nickel metal hydride (NiMH) batteries: Estimated battery life is not available because NiMH batteries vary greatly in manufacturer capacity and discharge curves. We recommend a NiMH D-cell battery with a minimum rating of 10,000 milliamp hours that is fully charged each time it is used.

2.3

Install / Remove Guard or Cal. Cup

Sensor guards protect EXO sensors from impact throughout deployment. Users must install the guard prior to data collection. The calibration cup (cal cup) is used for storage and calibration.

NOTE: We recommend using two guards: one for field deployments and a second used exclusively for calibrations. Using a second guard will minimize calibration solution contamination (especially for turbidity). EXO calibration cups install over an installed sensor guard. This configuration reduces the amount of standards required for calibration and protects the sensors during calibration.

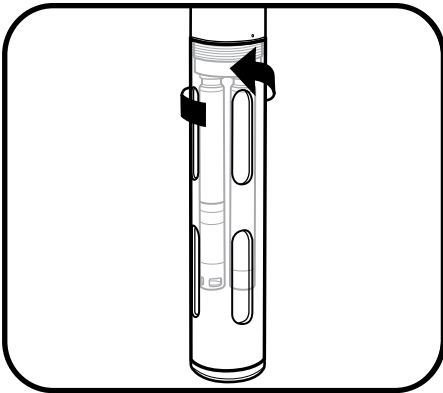

1 Install/remove sensor guard

Install guard by threading it onto the sonde bulkhead threads. Rotate the guard clockwise on the bulkhead to install, taking care not to pinch your fingers. Rotate it counterclockwise to remove. Always use one guard for deployment/storage and a second guard for calibration only.

Additional EXO sensor guards can be purchased:

EXO1 Guard Assembly Kit, part #599666

EXO2/3 Guard Assembly Kit, part #599667

NOTICE: Take care not to let the guard damage unguarded pH or pH/ORP sensors when installing and removing.

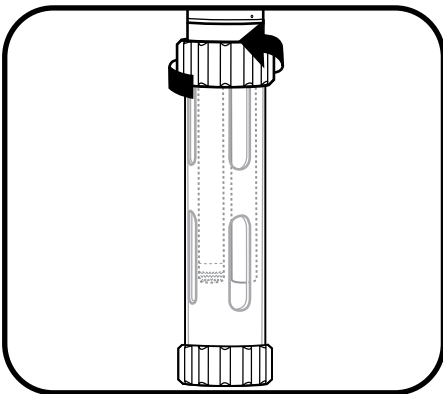

2 Install/remove calibration cup

Before installation, loosen (but do not remove) the cup's clamping ring. Then, with the sonde guard already installed, slide the cal cup over the guard until the bottom of the guard rests against the bottom of the cal cup. Tighten the ring until snug. To remove the cal cup, loosen the ring by 1/4 turn and pull the guard free from the cup.

Additional EXO calibration cups can be purchased:

EXO1 Calibration / Storage cup, part #599786

EXO2/3 Calibration / Storage cup, part #599316

2.4

Install / Remove Sensors

EXO sensors have identical connectors and identify themselves via onboard firmware; therefore, users can install any probe into any universal sonde port. The exception is the wiper for the EXO2 and EXO3 sondes, which must be installed in the central port 7. Individual ports are physically identified by an engraved number on the sonde bulkhead. Although the probes are wet-mateable, users should clean, lubricate, and dry the sonde and sensor connectors prior to installation or service.

NOTE: The data displayed on the Handheld / Desktop KorEXO, and the order of the exported data will be in the same order that the sensors are installed (e.g. a turbidity sensor in port 1 will display turbidity values first. The sensor in port 2, second, and so on).

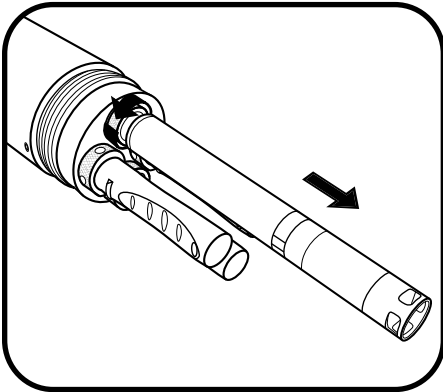

1 Remove probe or port plug

Remove the calibration cup and sensor guard from the sonde. Place the sonde on a clean, flat surface and prevent it from rolling.

If removing a sensor or port plug, use the probe tool in the locking nut and rotate counterclockwise to loosen. Pull the probe straight out of the port and place on a clean surface. Wipe dry with a clean, lint-free cloth.

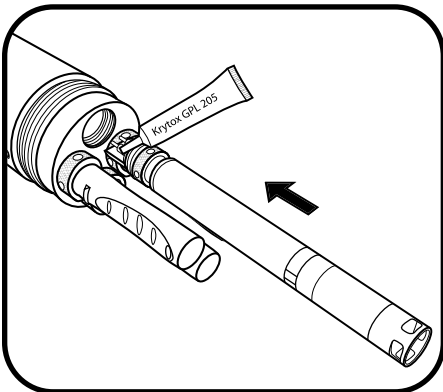

2 Clean port and install sensor

Visually inspect the port for contamination. If the port is dirty or wet, clean it with a clean, lint-free cloth or compressed air. Apply a light coat of Krytox grease to the rubber mating surfaces of the connector (not the o-ring) and a small dab of Krytox grease on the threads of the locking nut.

If the sensor is new or being taken out of storage remove any hydration caps or buffer bottles on the probe. Insert the sensor into the port by properly aligning the connectors' pins and sleeves (male and female contacts); then press them firmly together.

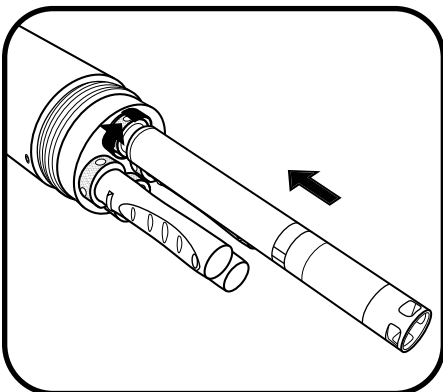

3 Tighten locking nut

Taking care not to cross-thread the grooves, finger-tighten the locking nut clockwise. When the nut and o-ring are seated against the bulkhead, tighten the nut with probe tool 1/4 turn until snug. Once sensors or plugs are installed, reinstall the sensor guard to protect sensors from impact damage.

NOTICE: Take care not to twist the probe body when tightening and loosening the locking nut. Excessive twisting of the probe can damage the connector and is not covered under warranty.

2.5

Sonde States and LED Descriptions

States

An EXO sonde is always in one of three operational states: *Off*, *Awake*, or *Asleep*. These states determine the sonde's power usage and logging potential. When *Off*, the sonde is not powered (no batteries installed, no topside power) and cannot collect data. Users can apply power to the sonde internally, using batteries, or externally with an EXO field cable attached from the topside port to an EXO Handheld, DCP or other approved power source. Once power is applied to a sonde, it is either *Awake* or *Asleep*.

When *Asleep*, the sonde remains in a very low power setting and waits for a user command or its next scheduled logging interval.

Power States

Off: Not powered, no data collection.

Asleep: Low power. Waiting for command.

Awake: Full power. Ready to collect.

LED Indicators

● Blue LED - Bluetooth

None: Off, not active

On Solid: On, not linked

2 Hz (0.5s Blink): On, linked

● Red LED - Sonde State

None: Off or Asleep, with logging disabled

0.1 Hz (10s Blink): Asleep, logging enabled

1 Hz (1s Blink): Awake, sensors are active and may collect data

On Solid: Awake with faults

An *Awake* sonde is fully powered and ready to collect data. Once awakened, a sonde remains *Awake* for five minutes after its last communication via *Bluetooth* or 30 seconds after its last communication via the topside port. The sonde also automatically awakens 15 seconds before its next scheduled logging interval.

LED Indicators

Each sonde has two LED indicators that show the sonde's status. The blue LED indicates the *Bluetooth's* wireless connection status. The red LED indicates the sonde's power state.



The *Bluetooth* light (blue) is activated by a magnet swipe at the magnetic activation area. When the blue LED is off, the *Bluetooth* is disabled. When the light is on continuously, the *Bluetooth* is enabled, but no link has been established. When the blue LED blinks at 2 Hz, the sonde's *Bluetooth* is on, and has established a link.

When the red LED is off, the sonde is either *Off* or *Asleep* and not logging. When it blinks at 0.1 Hz (once every 10 seconds), the sonde is *Asleep* and logging is enabled. When the red light blinks at 1 Hz, the sonde is *Awake* and has no faults. If the red light is lit continuously, the sonde is *Awake* and has detected faults that need to be fixed prior to use.

Modes

Within the *Awake* state, the sonde has three modes, which are activated via KorEXO software. When "Inactive (Off)," the sonde does not log any data. In "Real-Time" mode, the sonde continuously collects data at a user-specified interval (default is 2 Hz). "Sample/Hold" mode allows users to easily synchronize data between the sonde's data logger and an external data collection platform.

2.6

Connection Methods

Overview

Below is a high level overview of various methods you can use to connect and communicate with your EXO sonde:

 A handheld sonde, a coiled cable, and a handheld device.	Field Cable, Sonde-to-Handhelds <ul style="list-style-type: none">• Lab Calibration• Hardware Setup• Transfer Data from Sonde• Field Sampling
 A laptop with the Kor logo, a wireless signal icon, and a handheld sonde.	Wireless Bluetooth, Computer-to-Sonde <ul style="list-style-type: none">• Lab Calibration• Hardware Setup• Transfer & Export Data
 A laptop with the Kor logo, an EXO GO Bluetooth device, and a handheld sonde.	EXO GO Bluetooth, Sonde-to-Computer <ul style="list-style-type: none">• Lab Calibration• Hardware Setup• Transfer & Export Data• Field Sampling• Update Firmware
 A laptop with the Kor logo, a SOA-USB adapter, and a handheld sonde.	SOA-USB Adapter, Sonde-to-Computer <ul style="list-style-type: none">• Lab Calibration• Hardware Setup• Transfer & Export Data• Field Sampling• Update Firmware
 A laptop with the Kor logo, a USB symbol, and a handheld device.	Direct USB, Computer-to-Handhelds <ul style="list-style-type: none">• Transfer & Export Data• Update Firmware
 A flying lead cable, a handheld sonde, and a computer adapter.	Flying Lead Cable, Sonde-to-Com. Adapter <ul style="list-style-type: none">• Long-Term Monitoring with a Data Collection Platform or SCADA Modbus
 A laptop with the Kor logo, a USB passthrough adapter, and a handheld sonde.	USB Passthrough Mode <ul style="list-style-type: none">• Direct USB communication to sonde, through DCP 2.0 / Modbus using KorEXO software.

2.7

Awaken Sonde

Activate *Bluetooth*

Once power is applied to the sonde, internally or externally, users can awaken their sondes from *Sleep* state using any of several methods. Primarily, users activate EXO sondes and the *Bluetooth* connections via a magnetic switch installed in the sonde's electronics compartment. The sonde will automatically disable the connection and go to sleep if it has received neither a *Bluetooth* signal for 5 minutes, nor a signal from the topside connector for 30 seconds. In order to activate their sondes, users should keep a magnet with them when setting up and deploying sondes. For more information on sonde states and LEDs, see [Section 2.5](#).

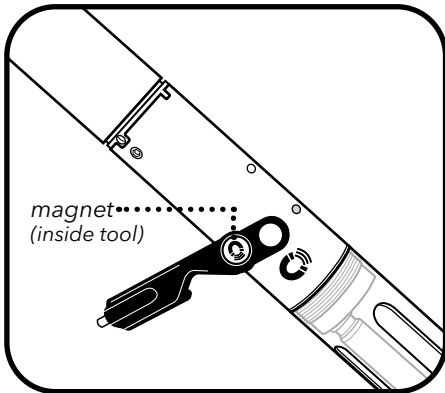

1 Awaken sonde with magnet

Users can make their sonde go to the Awake state by holding a magnet at the magnetic activation area on the sonde's bulkhead (identified by the illustrated magnet symbol on the label). Simply hold the magnet within one (1) cm of the symbol until the LEDs activate. EXO Classic Handhelds and sensor removal tools contain embedded magnets identified by the same symbol.



NOTE: The sensor removal tool was updated in 2014. Item #599469 "EXO Sensor Tool Kit".

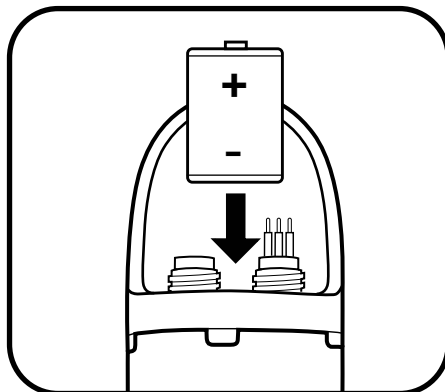

2 Awaken sonde without magnet

Users can also make their sonde go to the Awake state using any of the following methods.

- Cycling power to the sonde (uninstalling/installing batteries).
- Communicating via the topside port.
- Inserting a sensor.

In addition to these manual methods, the sonde also automatically awakens for scheduled unattended logging (programmed in KorEXO).

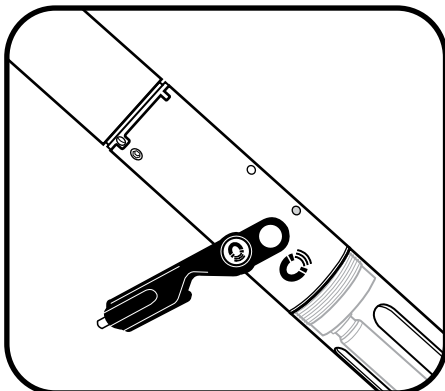

3 Activate sonde's *Bluetooth*

Users activate *Bluetooth* by holding a magnet at the magnetic activation area in the same way as described in Step 1. In addition to magnetic activation, users can also activate *Bluetooth* by:

- Cycling power to the sonde (uninstalling/installing batteries).
- Enabling *Bluetooth* via a connection at the topside port using KorEXO.

2.8

Connect Sonde

Bluetooth

Before users can communicate wirelessly with their EXO sondes, they must establish a *Bluetooth* link. All EXO sondes are equipped with *Bluetooth*. This technology provides a secure, two-way, reliable communication channel with which users can communicate with their sondes above water without cables. Many new computers are equipped with *Bluetooth* wireless installed internally; those without *Bluetooth* can use a *Bluetooth* dongle (not included). Follow the manufacturer's instructions for installing the dongle's software and hardware.

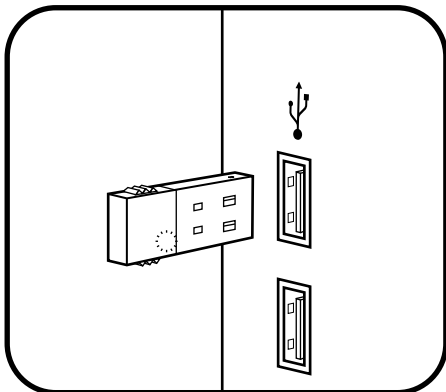

1 Install *Bluetooth* dongle (optional)

If your computer is not equipped with internal *Bluetooth* radio, insert a *Bluetooth* dongle (not provided) into any of the computer's USB ports. Wait for the computer to automatically install the device and its drivers. Once the installation is complete, the computer should indicate that the device is installed and ready to use.

The preferred *Bluetooth* configuration is Windows 7 with native Windows *Bluetooth* drivers and software.

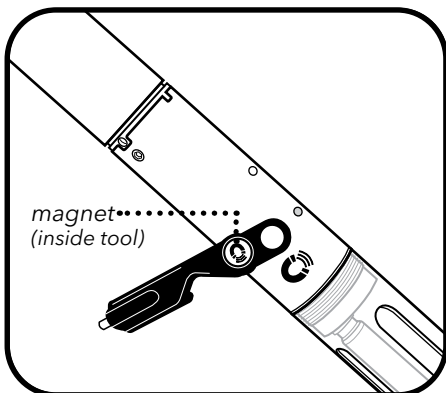

2 Activate sonde's *Bluetooth*

Users activate *Bluetooth* wireless by holding a magnet at the magnetic activation area. In addition to magnetic activation, users can also activate *Bluetooth* by:

- Cycling power to the sonde (uninstalling/installing batteries).
- Enabling *Bluetooth* via a connection at the topside port using KorEXO.



3 Establish *Bluetooth* Connection

1. Launch KorEXO Software.
2. Click the Scan for *Bluetooth* Devices button in the Instrument Connection Panel.
3. This might need to be repeated several times before the software finds the sonde.
4. Once the EXO Sonde appears, simply click the Connect button to establish communications.

An option to Automatically Connect to Instrument is available in the General Settings.

2.9

Connect Sonde

SDI-12 - EXO3 Only

The EXO3 Sonde includes native SDI-12 output for use with flying lead cables for a direct interface into 3rd party DCP systems. A communication adapter is NOT required for EXO3 SDI-12 communication. Refer to the wiring diagram below for connecting the cable to a terminal:

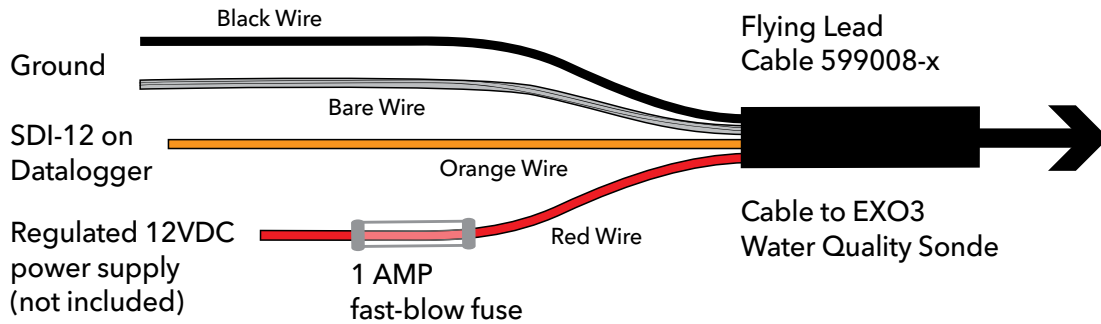

The EXO1 and EXO2 Sondes must be paired with a DCP Signal Output Adapter in order to achieve SDI-12 output. See [Section 2.11](#) for more information.

2.10 Communication Adapters

Overview

The EXO platform now offers expanded communication adapter (com. adapter) options. Below is a high level overview of the com. adapter options available to you. Choosing the right adapter for your application, based on the desired communication protocol, will be a key factor in the success of your project.

NOTE: Each communication adapter requires its own USB driver update, go to YSI.com/KorEXO to download the latest software and drivers.



EXO USB Signal Output Adapter (599810)

This adapter supports a connection between an EXO sonde and a PC through a wired USB interface with the top-side connector. Transfer files and make changes to the sonde from your laptop or other USB ready smart device.

See [Section 2.11](#) for EXO SOA connection instructions.



EXO DCP Signal Output Adapter 2.0 (599820)

The DCP-SOA is intended for use in long term monitoring applications and requires an EXO sonde, data logger, and flying lead cable to function. This adapter converts an EXO sonde signal into either SDI-12 or RS-232.

See [Section 2.12](#) for more information on the EXO DCP SOA 2.0



EXO Modbus Signal Output Adapter (599825)

The Modbus SOA is intended for use in a SCADA system and requires an EXO sonde and flying lead cable to function. This adapter converts an EXO signal into a Modbus protocol over RS-232 or RS-485.

See [Section 2.15](#) for more information on the EXO Modbus SOA.

2.11

Communication Adapters

USB

The USB signal output adapter (USB-SOA 599810) allows users to connect to an EXO sonde over a standard USB connection. Although the USB-SOA is rugged and water resistant, users should protect its connectors with the included cap when not in use.

NOTICE: The SOA should never be submerged.

Prior to use, users must install KorEXO software and its drivers on the associated PC. The USB-SOA will not work without the drivers that accompany KorEXO. Drivers are included with the KorEXO Software download. Visit YSI.com/KorEXO for the latest drivers.

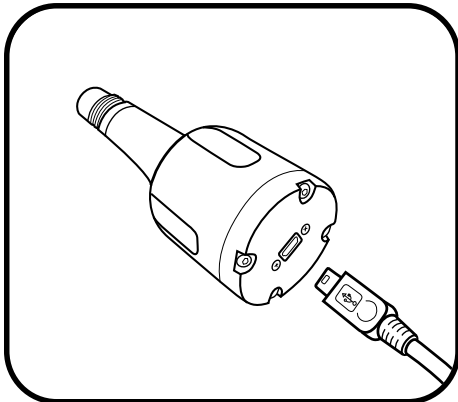

1 Connect USB cable to SOA and PC

Remove the protective cap from the USB end of the SOA, and ensure that the connector is clean and dry. Then insert the small end of the provided USB cable into the SOA connector and the large, standard side into one of the PC's USB ports. *The sonde should not be connected at this time.*

Attaching the adapter to the PC causes a new device to be recognized. Windows automatically installs the drivers and creates a new port. Each new adapter that is attached creates a new port.

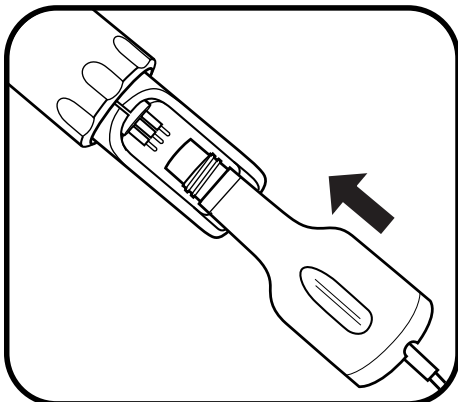

2 Connect SOA to sonde

Remove the plug from the male 6-pin connector on the sonde. Apply a light layer of Krytox grease to the male pins on the sonde and the female connector on the USB-SOA. Then align the connector's six pins and jackets, and press them firmly together so that no gap remains.



Ports

KorEXO automatically scans ports for USB adapters. To view the USB adapter and its associated com port, go to the Control Panel on your computer, click Device Manager, then click Ports.

2.12

Communication Adapters

Data Collection Platform 2.0 (DCP)



Delivering quality data where and when you need it most.

Introduction:

The 599820 is a communication adapter for the EXO multiparameter sonde platform. It converts the proprietary signal from the water quality sonde into either SDI-12 or RS-232 signals. The adapter simplifies integration into 3rd party DCP systems, and also features a USB port that supports passthrough communication directly to the connected sonde. This feature allows configuration, calibration, and data transfer without having to disconnect the field cabling.

Adapter Overview:

Supply Power, 12VDC
Provided from external regulated power source (not included).

SDI-12 & RS-232 I/O Terminal
Use either SDI-12 or RS-232 terminals.

! Safety:

Do not attempt electrical wiring beyond your skill level. Follow all applicable code and regulations subject to electrical wiring and operation of the system.

Mini USB Connector

Provide power to the adapter, and passthrough communication to the sonde.



Status LED

Magnetic Read Switch
Used to rediscover attached sonde.

Specifications

Supply Voltage: 9 - 16 VDC or USB 5 VDC

Current Draw Adapter:
~20mA typical (@12VDC)

Current Draw Sonde: ~sleep 0.25mA reading and 100mA during operation

Max Net Current Draw for Systems:
~120mA (@12VDC)

Dimensions: L=3.5", W=3.5", H=1.5" (8.9cm x 8.9cm x 3.8cm)

Operating Temp: -40°C to +60°C

Storage Temp: -50°C to +80°C

Humidity: 0 to 99% non-condensing

➤ What's Included:

The 599820 EXO Communication Adapter comes with:

- (1) DCP 2.0 Adapter
- (3) green wiring terminal blocks (Sonde 5-pin, Power 2-pin, DCP 7-pin)
- (1) Panel mounting bracket
- (1) Hook and loop fastener

If any item is missing, please contact info@ysi.com for replacements.

➤ You'll also need:

- Flat blade screwdriver for terminal blocks
- Phillip's screwdriver for panel mount bracket
- EXO magnetic sensor tool (optional)
- EXO Flying Lead Field cable (599008-x)
- EXO sonde system, sensors, and associated hardware
- Latest KorEXO software (available from [YSI.com](http://ysi.com))

Getting Started

Mounting:

The adapter should be protected from the elements, and it is recommended it be mounted inside of a sealed enclosure with desiccant to prevent condensation.

The adapter includes a panel mount in addition to self-adhesive hook and loop fastener. Either of these two methods can be used to securely mount the adapter. Use the provided Phillips screw to secure the panel mount:

Panel Mount

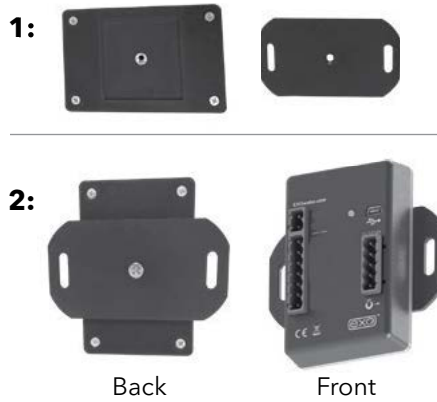

Self-Adhesive Hook and Loop Fastener

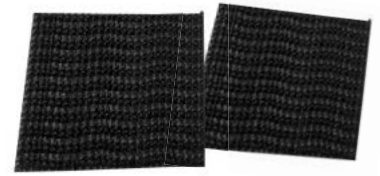

NOTE: If using self adhesive hook and loop, clean and dry both surfaces before applying.

NOTE: This adapter is not required for use of SDI-12 with an EXO3 sonde. It is however, still required, if you need RS-232 communications.

Status LED Indications	
Off	No power
On, no flashing	No Sonde connected
Flashing at 1 Hz	Sonde connected, everything normal
Flashing at 0.1 Hz	Low power sleep (Will flash on for 1 second when magnetic switch is activated.)

Wiring

Have the following ready:

- EXO Sonde
- DCP 2.0 Adapter
- Flying Lead Cable
- Desiccant if using Vented Cable
- Flat blade screwdriver
- Power & Data Logger Wires



Webinar | A Simple Guide to Collecting Water Quality Data
Learn the basics of wiring your Sonde up to a DCP:
<https://goo.gl/B4PPK7>

➤ Wiring Continued

Next wire the flying lead cable, power, and DCP ports as labeled in one of the following configurations:

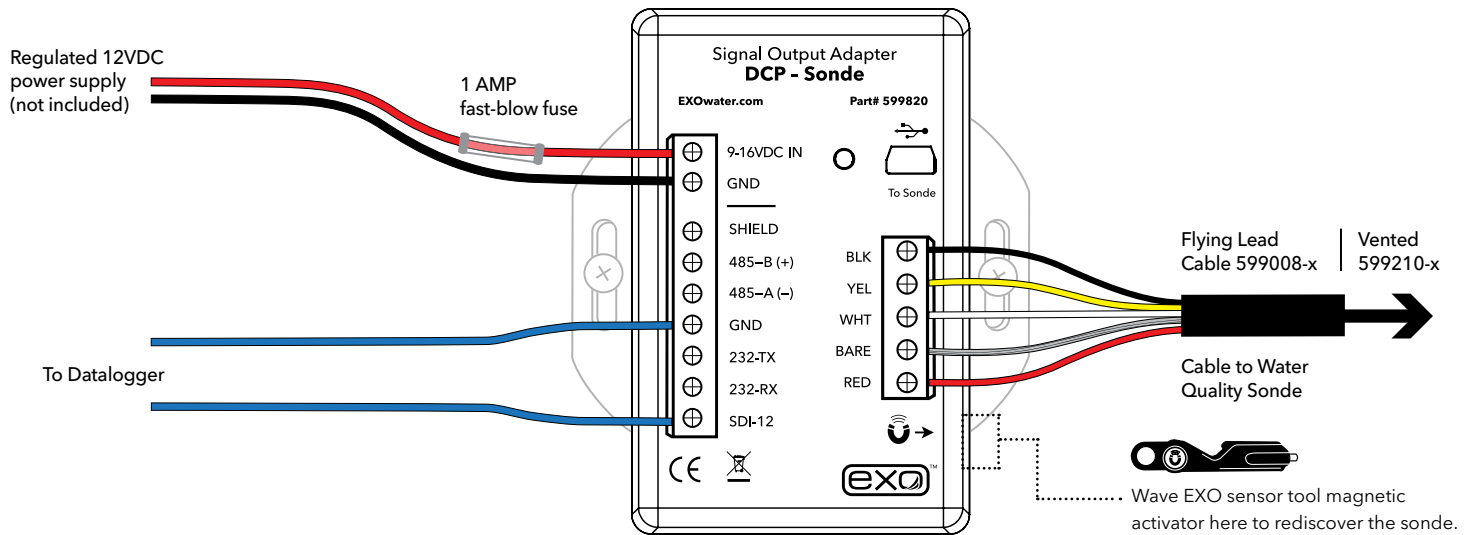

OR

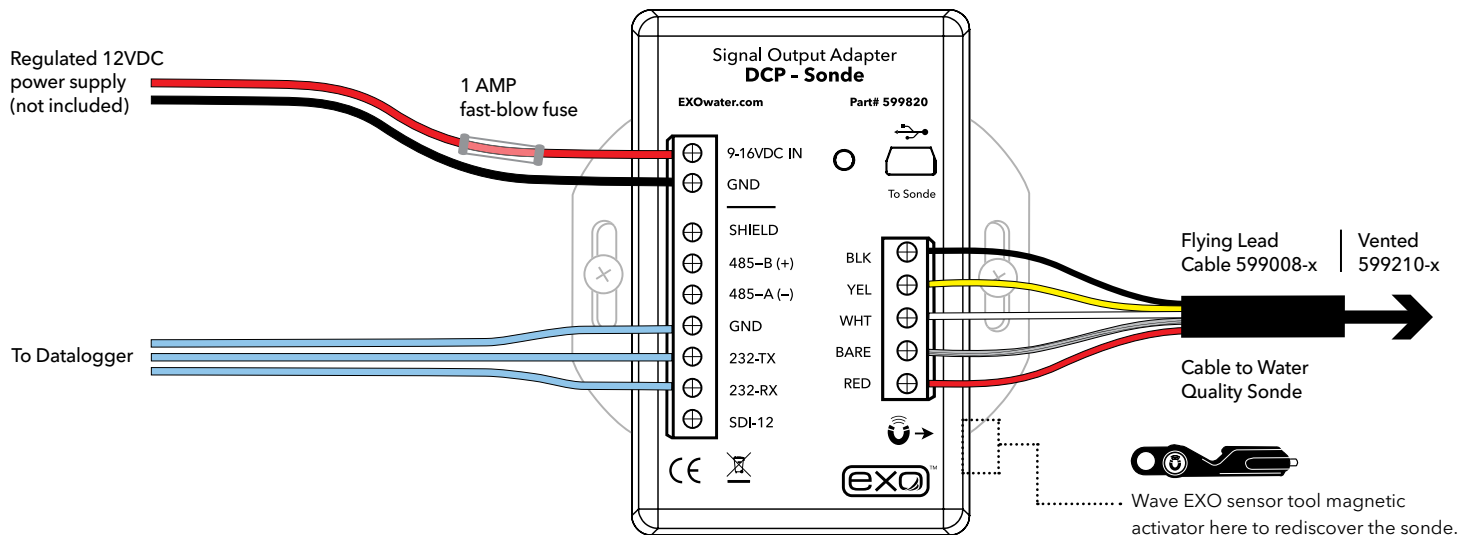

When connecting new sondes to the DCP adapter, it may be necessary to redetect the sonde. This can be done by power cycling the adapter or by using the magnetic read switch at the lower right hand side of the enclosure. Waving the magnet in the EXO sensor tool over the area referenced by the square above, will force a network redetect where all new sensors and configurations will be discovered.

NOTE: The orange wire on the flying lead cable to the sonde will not be used when connecting EXO to a Signal Output Adapter. It can be taped back during installation.

➤ USB Passthrough Mode

The 599820 DCP Signal Output Adapter can function in a similar fashion as the 599810 USB communication adapter. After the Signal Output Adapter is wired as shown in the previous configuration, connecting to the USB port on the adapter will allow direct communications with the sonde using KorEXO software. Make sure drivers are installed before attempting USB communication; see [Section 3.2](#) for driver installation instructions.



NOTE: USB utilizes Communication Device Class (CDC) and installs as com port on PC: "YSI SOA/DCP Gen2". The USB connection may also be used to update firmware on the adapter using KorEXO software.

➤ Output Configuration

In order to appropriately setup a sonde to communicate measurements to a datalogger, it is critical to align the settings from the sonde and the logger.

In the KorEXO software |**Deployment Settings**| choose the parameters and sort order, then push the template to the sonde.

The complete list of parameters is shown in the left column and the selected parameters to output via the DCP 2.0 adapter are shown on the right. This template can be saved locally on the PC, but it must also be pushed down to the sonde for the settings to take effect. So be sure to apply the template to the sonde.

NOTE: There are two options when applying the template to the sonde, apply without logging or with logging. Either option may be used. When deploying with logging the sonde will create a redundant log file inside the sonde. Without logging the data will only be available to the RS-232 or SDI-12 outputs.

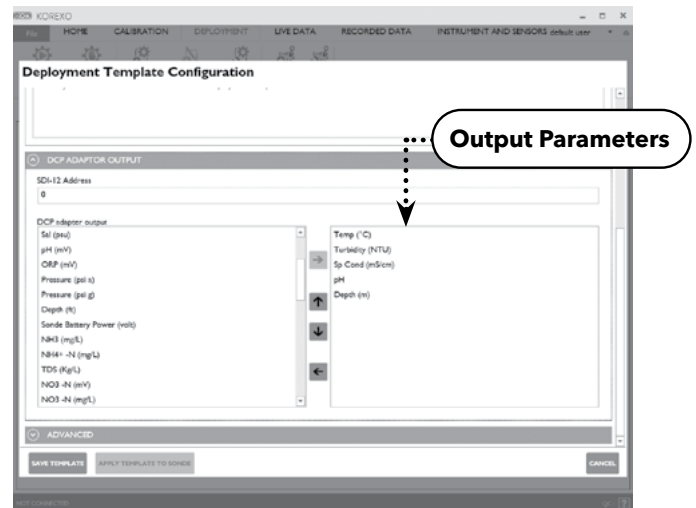

KorEXO Version 2.0.x

NOTE: If settings are changed, power must be cycled for the Signal Output Adapter.

EXO DCP Signal Output Adapter Programming Basics

1. SDI-12 Interface

• General

- Compatible with v1.3 of SDI-12 specification
- Supports following standard commands:
 - '!' Address Query
 - 'A' Change Address
 - 'C' Concurrent Measurement
 - 'D' Data
 - 'I' Identification
 - 'M' Start Measurement
 - 'V' Start Verification

• Extended Commands

- SDI-12 'Z' command
- Supports the following RS-232 commands:
 - 'sn' Serial Number
 - 'para' Parameter List
 - 'twipeb' Start wipe
 - 'ver' S/W version
 - 'ssn' Sensor Serial Numbers

2. RS-232 Interface

• General

- Command Line
- '#' is user prompt
- Commands are not case sensitive
- Only spaces are recognized as delimiters
- A command is terminated by a <CR>
- Minimum time from power up to valid readings is 19 seconds

• Command List

- See RS-232 commands in [Section 2.13](#)
- See SDI-12 Port Settings in [Section 2.14](#)

An example of a NEMA enclosure where the DCP Signal Output Adapter is wired.



2.13 Communication Adapters

RS-232

The EXO DCP Signal Output Adapter (SOA) supports limited RS-232 commands. The SOA supports both SDI-12 and RS-232 communications. The order of the RS-232 parameter output is controlled by the SDI-12 tab on the deployment menu.

[] indicates argument is optional <i> indicates argument is an integer

data

Returns one line of data readings. Data parameters specified in para command. Data delimiter is specified in the setdelim command.

dowait [<i>]

Turns "wait for DO" on if <i>=1 and off if <i>=0. The response is "OK". If you do not supply <i>, then the response is the current value of dowait. When enabled the SOA/DCP will not return data until sonde has been on for "dowarmup" seconds.

dowarmup [<i>]

Sets DO sensor warmup time where <i>=warmup time in seconds. The response is "OK". If you do not supply <i>, then the response is the current value for dowarmup. When "dowait" is enabled the SOA/DCP will not return data until sonde has been on for "dowarmup" seconds.

fltreset

Resets all sonde sensor filters. The response is "OK".

hwipesleft

Returns a value other than 0 if a wiper event is in progress. The value returned is normally the amount of "half" wipes that are left to go. When wiping is completely finished, the value will go to 0.

para

Returns the parameter numbers of all parameters selected for output. Each number returned matches one for one with the values returned in the data command. The numbers are space delimited.

para [<i1> <i2> <i3> <i4> ...]

Sets the data parameter codes used with the data and run commands. The parameters are space delimited. If you do not supply any parameters then the response is the current list of parameters. Maximum number of parameters is 32.

pwruptorun [<i>]

Turns "power up to run" on if <i>=1 and off if <i>=0. The response is "OK". If you do not supply <i>, then the response is the current value of pwruptorun.

run

Causes the sonde to SOA/DCP to take sonde readings at a 1Hz rate. The output is similar to the Data command except that readings are taken continuously. No headers are output. To abort send '0', <esc>, or turn power off to the SOA/DCP and then reapply.

setcomm [<i1>] [<i2>]

Changes the SOA/DCP's comm port baud rate and data length. The baud rate will be immediately changed after this command, so you will need to reconfigure your terminal to match.

<i1> can be:

2 - 1200 baud	6 - 19200 baud
3 - 2400 baud	7 - 38400 baud
4 - 4800 baud	8 - 57600 baud
5 - 9600 baud (default)	9 - 115200 baud

<i2> can be:

- 0 - 7 bits
- 1 - 8 bits

Send these commands to the DCP via an RS-232 hyperterminal window configured with the following:

Bits per second	9600
Data bits	8
Parity	None
Stop bits	1
Flow control	None

setdelim [*<i>*]

Changes the SOA/DCP's delimiter used in the data command response. If you do not supply *<i>*, then the response is the current value for delimiter.

<i> can be: 0 = space, 1 = TAB, 2 = comma, 3 = none

setecho [*<i>*]

Enables (*<i>*=1) or disables (*<i>*=0) command echoes. When echoes are disabled, commands sent to the SOA/DCP will not be 'echoed' back and there will be no '#' prompt. If you do not supply *<i>*, then the response is the current value for echo.

setmode [*<i>*]

Sets the RS232 mode. If *<i>*=0, mode is normal. If *<i>*=1 mode is NMEA. If you do not supply *<i>*, then the response is the current value for mode.

setradix [*<i>*]

Sets the radix point used for data output. If *<i>*=0 radix will be '.'. If *<i>*=1 radix will be ','. Note that in SDI-12 mode, the response to a 'D' command will always be with '.' regardless of this setting. The response is "OK". If you do not supply *<i>*, then the response is the current value for radix.

setsonde [*<i>*]

Selects a sonde for RS-232 communications when sondes are daisy-chained. *<i>* represents the order of the sonde in the chain where 1st sonde = 0, 2nd = 1, 3rd = 2. The response is "OK". If you do not supply *<i>*, then the response is the current value for the sonde.

sn

Returns the unique serial number programmed into every YSI sonde.

ssn

Returns the unique serial number for the sonde and all attached sensors.

setperiod [*<i>*]

Sets the period for the data output in RUN mode. The period is set to *<i>* milliseconds. Minimum value is 250 (1/4 second), maximum value is 30000 (30 seconds). If you do not supply *<i>*, then the response is the current value for period. For periods less than 1000 and baud rates below 9600, the data output may be unreliable.

time [*<hh:mm:ss>*]

Allows user to set time in the sonde in the HH:MM:SS format. The response is "OK". If you do not supply *<hh:mm:ss>*, then the response is the current value of time.

twipeb

Starts a wiper event. The response is the approximate time in seconds it will take to perform the wipe.

ver

Returns the software version number of the sonde.

verdate

Returns the time and date at which the current version of software in the sonde was compiled.

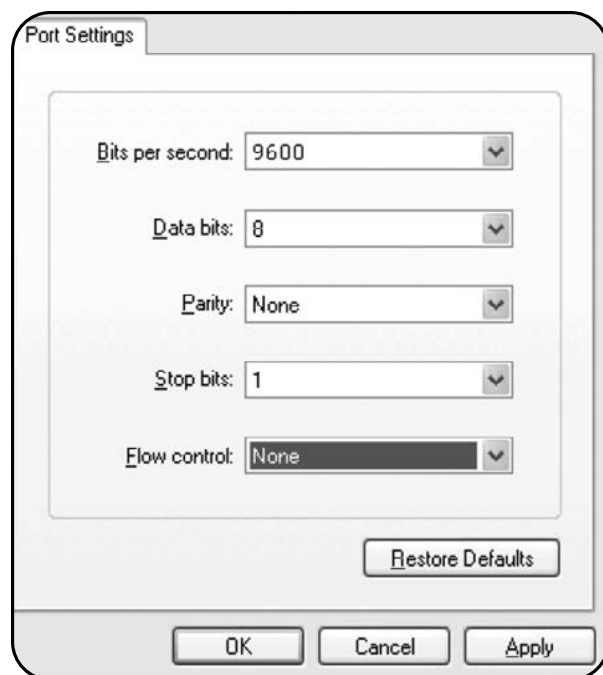

RS-232 settings should resemble this image.

2.14

Communication Adapters

SDI-12

The sonde can be connected to an SDI-12 bus using a DCP Signal Output Adapter (SOA). The SOA provides the necessary SDI-12 electrical interface and communicates to the sonde via the topside RS-485 interface. The SOA will automatically recognize when a sonde is connected and retrieve the SDI-12 address and ID from the sonde. The SDI-12 data parameter list is set by the user in the Deploy menu. Go to Deploy | Open Template | Edit Template menu and click on the SDI-12 tab.

- Maximum of 23 codes in sonde parameter list.

Parameter	Code
Temperature, °C	1
Temperature, °F	2
Temperature, °K	3
Conductivity, mS/cm	4
Conductivity, µS/cm	5
Specific Conductance, mS/cm	6
Specific Conductance, µS/cm	7
TDS, g/L	10
Salinity, PPT	12
pH, mV	17
pH	18
ORP, mV	19
Pressure, psia	20
Pressure, psig	21
Depth, m	22
Depth, ft	23
Battery, V	28
Turbidity, NTU	37
NH3 (Ammonia), mg/L	47
NH4 (Ammonium), mg/L	48
Date, DDMMYY	51
Date, MMDDYY	52

Parameter	Code
Date, YYMMDD,	53
Time, HHMMSS	54
TDS, kg/L	95
NO3 (Nitrate), mV	101
NO3 (Nitrate), mg/L	106
NH4 (Ammonium), mV	108
TDS, mg/L	110
Chloride, mg/L	112
Chloride, mV	145
TSS, mg/L	190
TSS, g/L	191
Chlorophyll, µg/L	193
Chlorophyll, RFU	194
PAR, Channel 1	201
PAR, Channel 2	202
Rhodamine, µg/L	204
ODO, %Sat	211
ODO, mg/L	212
ODO, %Sat Local	214
TAL-PC, cells/mL	215
BGA-PC, RFU	216
TAL-PE, cells/mL	217

Parameter	Code
BGA-PE, RFU	218
Turbidity, FNU	223
Turbidity, Raw	224
BGA-PC, µg/L	225
BGA-PE, µg/L	226
fDOM, RFU	227
fDOM, QSU	228
Wiper Position, V	229
External Power, V	230
BGA-PC, Raw	231
BGA-PE, Raw	232
fDOM, Raw	233
Chlorophyll, Raw	234
Potassium, mV †	235
Potassium, mg/L †	236
nLF Conductivity, mS/cm	237
nLF Conductivity, µS/cm	238
Wiper Peak Current, mA	239
Vertical Position, m	240
Vertical Position, ft	241
Chlorophyll, cells/mL	242

† **NOTE:** Potassium is considered future functionality, there is currently no EXO probe for Potassium (as of 2019).

2.15 Communication Adapters

Modbus



Delivering quality data where and when you need it most.

Introduction:

The 599825 is a communication adapter for the EXO multiparameter sonde platform. It converts the proprietary signal from the water quality sonde into a Modbus protocol over either RS-232 or RS-485 signals. The adapter simplifies integration into 3rd party SCADA systems, and also features a USB port that supports passthrough communication directly to the connected sonde. This feature allows configuration, calibration, and data transfer without having to disconnect the field cabling.

Specifications
Supply Voltage: 9 - 16 VDC or USB 5 VDC
Current Draw Adapter: ~20 mA typical (@12 VDC)
Current Draw Sonde: ~sleep 0.25 mA reading and 100 mA during operation
Max Net Current Draw for Systems: ~120 mA (@12 VDC)
Dimensions: L=3.5", W=3.5", H=1.5" (8.9 cm x 8.9 cm x 3.8 cm)
Operating Temp: -40°C to +60°C
Storage Temp: -50°C to +80°C
Humidity: 0 to 99% non-condensing

Adapter Overview:

Supply Power, 12VDC
Provided from external regulated power source (not included).

Modbus I/O Terminal
Use either 485 (default) or RS-232 terminals.

Safety:

Do not attempt electrical wiring beyond your skill level. Follow all applicable code and regulations subject to electrical wiring and operation of the system.

Mini USB Connector

Used to configure adapter settings, provide power to the adapter, and passthrough communication to the attached sonde.

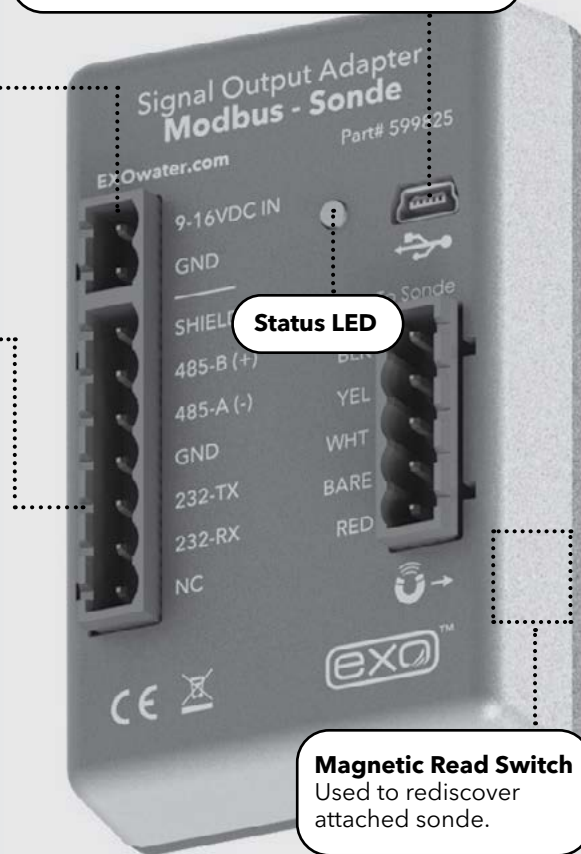

Status LED

Magnetic Read Switch

Used to rediscover attached sonde.

What's Included:

The 599825 EXO Communication Adapter comes with:

- (1) Modbus Adapter
- (3) green wiring terminal blocks (Sonde 5-pin, Power 2-pin, Modbus 7-pin)
- (1) Panel mounting bracket
- (1) DIN rail mounting bracket
- (1) Hook and loop fastener

If any item is missing, please contact info@ysi.com for replacements.

You'll also need:

- Flat blade screwdriver for terminal blocks
- Phillip's screwdriver for panel mount bracket or din rail bracket
- EXO magnetic sensor tool (optional)
- EXO Flying Lead Field cable (599008-x) or Vented Flying Lead cable (599210-x)
- EXO sonde system, sensors, and associated hardware
- Latest KorEXO software (available from [YSI.com](http://ysi.com))

Getting Started

Mounting:

The adapter should be protected from the elements, and it is recommended it be mounted inside of a sealed enclosure with desiccant to prevent condensation.

The adapter includes a panel mount or a DIN rail mount in addition to self-adhesive hook and loop fastener. Any of the three methods can be used to securely mount the adapter. Use the provided Phillips screw to secure the panel or din rail mount:

Panel Mount



DIN Rail Mount



Self-Adhesive Hook and Loop Fastener

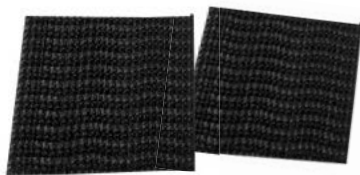

NOTE: If using self adhesive hook and loop, clean and dry both surfaces before applying.

Status LED Indications

Off	No power
On	No Sonde connected
Flashing at 1 Hz	Sonde connected, everything normal
Flashing at 1/10 Hz	Low power sleep (Will flash on for 1 second when magnetic switch is activated.)

Configuration:

Downloading the SOA Modbus Utility

The EXO SOA Modbus Utility must be installed on your computer in order to change settings. The utility is available for download from the YSI [Software Downloads](#) page.

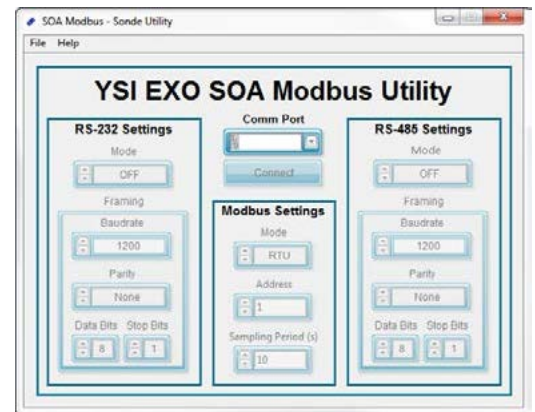

Connecting to the SOA Modbus Adapter

Method 1: Select the port by using the Comm Port selection box and then click Connect.

Method 2: Use the List Comm Ports user interface (UI) located in the Help menu to select a port. In the UI, double-click an application port and the application will automatically connect.

Configuring the SOA Modbus Adapter

Once you are connected, the application retrieves all of the current settings and displays them. To change a setting, modify the value of interest and the application will automatically update the SOA.

Default Settings

Bus: RS-485	Parity: None
Mode: RTU	Data Bits: 8
Baud rate: 9600	Stop Bit: 1
Modbus Address: 1 (AKA slave address)	

Make sure drivers are installed before attempting USB communication; see [Section 3.2](#) for driver installation instructions.

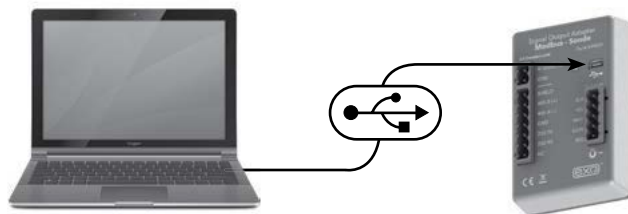

➤ Wiring

Have the following ready:

- EXO Sonde
- Com Adapter
- Flying Lead Cable
- Flat blade screwdriver
- Power & SCADA Wires



Next wire the flying lead cable, power, and Modbus ports as labeled:

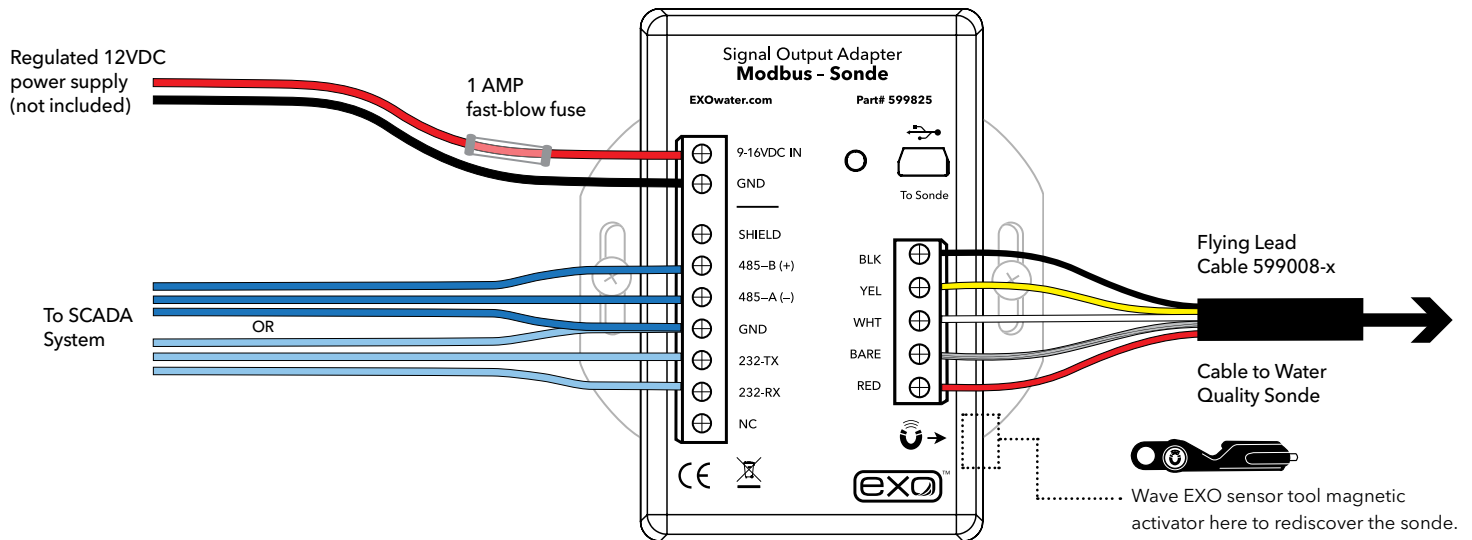

NOTE: The orange wire on the flying lead cable to the sonde will not be used. It can be taped back during installation.

NOTE: 3rd party RS-485 to TCP adapters may be used in conjunction with the EXO Modbus Adapter, however we are unable to provide specific support or configuration settings for these modules. The gridconnect "Net485" adapter has been successfully used in applications requiring TCP Modbus interface.



When connecting new sondes to the Modbus adapter, it may be necessary to redetect the sonde. This can be done by power cycling the adapter or by using the magnetic read switch at the lower right hand side of the enclosure. Waving the magnet in the EXO sensor tool over the area referenced by the square above, will force a network redetect where all new sensors and configurations will be discovered.

➤ USB Passthrough Mode

The 599825 Modbus Adapter can function in a similar fashion as the 599810 USB communication adapter. It will power the device and provide limited power to the sonde. After the Modbus adapter is wired as shown in the previous configuration, connecting to the USB port will allow direct communications with the sonde using KorEXO software.



NOTE: USB utilizes Communication Device Class (CDC) and installs as com port on PC: "YSI SOA/DCP Gen2". The USB connection may also be used to update firmware on the adapter using KorEXO software.

➤ General Modbus Information

- Register references are to the typical Holding Registers. Depending on your SCADA system these may be the 400,000 registers, the 40,000 registers, or simply the register values defined in this document. In this document the register value will generally be used. In all cases the register value will be +1 from the address value.
- The Output adapter makes use of the Modbus Holding register system to transfer data. It will respond to the Modbus commands "Read Holding Registers", "Write Single Register" and "Preset Multiple Registers". For all other commands the 599825 Modbus Adapter will return an illegal function exception. In general if you attempt to read or write from to a reserved or unused area, the 599825 Modbus adapter will return an illegal data access exception.
- The 599825 Modbus adapter is a slave device.
- The Modbus adapter maintains a current set of data in the holding registers. Use the "Read Holding Registers" command to obtain the most recent set of data from sonde connected to the 599825 Modbus adapter. Each parameter from the EXO water quality sonde is stored in a different register (or register pair). Also in different registers is status information from the 599825 Modbus adapter and the same command is used to read status. Values in still other registers control which parameters are enabled in the sonde. Programmers can enable and disable sonde parameters by writing to these registers using the "Preset Multiple Register" command.
- There are 3 main register areas to deal with the parameters:
 - Parameter type
 - Parameter status
 - IEEE floating point parameter data (Scaled integer parameter data, available but not recommended for use.)

Each of these areas is 32 registers long, except for the floating point data area which is 32 register pairs long. The first register (or register pair for the floating point data) in each area corresponds to the first parameter, the second corresponds to the second parameter, etc.

An example of a NEMA enclosure where PLC + Modbus adapter are wired.



➤ General Modbus Information

40,000 Read Holding Address	40,000 Read Holding Register	Read/Write	Description
0	1	Read/Write Single Reg	Sample Period: The period in seconds at which the SOA will sample the sonde data and update holding registers (value between 0-3600)
1	2	Write Only Single Reg	Force Sample: Write any value here to force the SOA to update holding registers with sonde data allow 15 seconds for values to show up in data registers
2	3	Write Only Single Reg	Force Wipe: Write any value here to force the connected sonde to run its wiper
3-127	4-128	--	Unused - reserved for future special functions
128-159	129-160	Read/Write	Parameter type: The PLC must write to this area to tell the SOA what parameters it wants. Up to 32 parameters can be written here. After the last parameter the PLC must write a "0. The table on the " Available Parameters Codes " page lists the valid parameter type codes.
160-225	161-256	--	Reserved for future parameter type
256-287	257-288	Read Only	Parameter status: The PLC can read back the values in these registers to check the status of the parameters. The value in register 257 corresponds to the parameter type in register 129 and so on. The meaning of the returned value is: 0 - The parameter is available. 1 - The parameter type has not been set (i.e. type = 0) 2 - The parameter requested is not currently available.
288-383	289-384	--	Reserved for future parameter status
384-447	385-448	Read Only	IEEE 754 Floating point parameter data: This is the actual parameter data in floating point form. Two registers are used for each value to make up the 32 bits required for a 4 byte IEEE floating point number. The value in register pair 385:386 corresponds to the parameter type in register 129 and so on. It is highly recommended that this be used rather than the scaled integer format.
448-639	449-640	--	Reserved for future IEEE floating point parameter data
640-671	641-672	Read Only	Scaled integer parameter data: The PLC should only read data from the SOA using this method if it cannot handle floating point data. Most PLCs can manipulate floating point values, so you should try to avoid reading scaled integer values. The value in register 641 corresponds to the parameter type in register 129 and so on. The values are scaled according to a fixed table in the SOA. The scaled data is in an unsigned integer format. Each parameter type has a specific range and resolution. Refer to the scaled integer range table (page 8) for values for each parameter. For example, temperature °C has the range of -50 to 605.35, with a resolution of 0.01. Here are some integer values that could be returned along with their engineering equivalents: 0: -50°C or less. 1: -49.99°C 2: -49.98°C 5000: 0°C 7234: 22.34°C 7500: 25°C 65534: 605.34°C 65535: 605.35°C or higher
672-767	673-768	--	Reserved for future scaled integer parameter data
768+	769+	--	Unused

Common Acronyms: PCL Programmable Logic Controller
 SCADA Supervisory Control and Data Acquisition

➤ Registry Configuration

This section deals with mapping the water quality parameter types to the respective holding register 129-160. These are the measurement values generated by the water quality sonde. There are two methods to set the parameter map. The preferred method is to use the deployment templates available in any version of KorEXO. This standard functionality allows the parameters to be selected and saved. Alternatively the registers may be directly written by the SCADA system.

In the KorEXO software |**Deployment Settings**| choose the parameters and sort order, then push the template to the sonde.

The complete list of parameters is shown in the left column and the selected parameters to output via the Modbus adaptor are shown on the right. This template can be saved locally on the PC, but it must also be pushed down to the sonde for the settings to take effect. So be sure to apply the template to the sonde.

NOTE: *There are two options when applying the template to the sonde, apply without logging or with logging. Either option may be used. When deploying with logging the sonde will create a redundant log file inside the sonde. Without logging, the data will only be available to the SCADA system.*

In the example below: Temp °C, Turbidity, SpCond, pH, and Depth M were chosen. This will automatically create a register map as follows:

Read Holding Address	Read Holding Register	Read/Write	Value	Description
128	129	Read/Write	1	The parameter code for Temp °C is displayed here
129	130	Read/Write	223	The parameter code for Turbidity (FNU or NTU) is displayed here
130	131	Read/Write	6	The parameter code for Sp Cond ms/cm is displayed here
131	132	Read/Write	18	The parameter code for pH is displayed here
132	133	Read/Write	22	The parameter code for Depth M is displayed here
133	134	Read/Write	0	Zero indicates the end of the register/parameter map

These register maps are stored in the sonde, and automatically program the 599825 Modbus adapter when power cycled or the magnetic read switch is activated. The alternative method is to write these parameter codes using the SCADA system in the format indicated above.

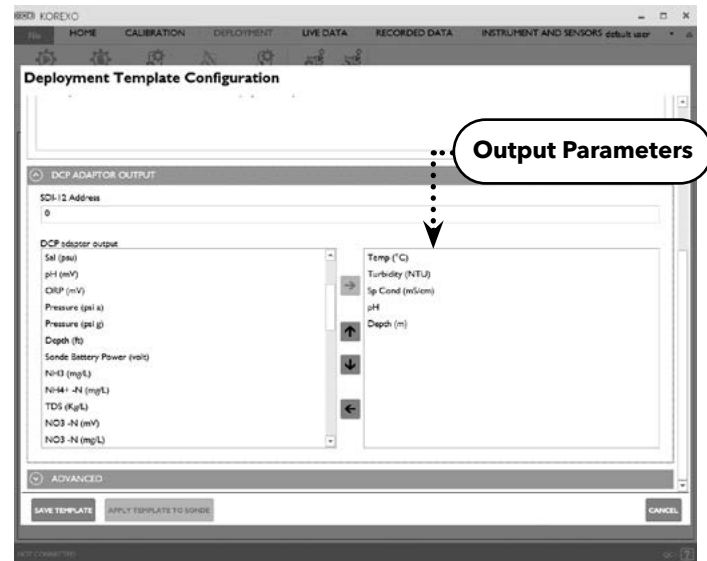

KorEXO Version 2.0.x

➤ Available Parameter Codes

The alternative setup method is to write these parameter codes using the SCADA system in the format indicated. The table below is the reference list of all available parameter codes for Read Holding Registers 129-160.

Parameter	Code
Temperature, °C	1
Temperature, °F	2
Temperature, °K	3
Conductivity, mS/cm	4
Conductivity, µS/cm	5
Specific Conductance, mS/cm	6
Specific Conductance, µS/cm	7
TDS, g/L	10
Salinity, PPT	12
pH, mV	17
pH	18
ORP, mV	19
Pressure, psia	20
Pressure, psig	21
Depth, m	22
Depth, ft	23
Battery, V	28
Turbidity, NTU	37
NH3 (Ammonia), mg/L	47
NH4 (Ammonium), mg/L	48
Date, DDMMYY	51
Date, MMDDYY	52

Parameter	Code
Date, YYYYMMDD,	53
Time, HHMMSS	54
TDS, kg/L	95
NO3 (Nitrate), mV	101
NO3 (Nitrate), mg/L	106
NH4 (Ammonium), mV	108
TDS, mg/L	110
Chloride, mg/L	112
Chloride, mV	145
TSS, mg/L	190
TSS, g/L	191
Chlorophyll, µg/L	193
Chlorophyll, RFU	194
PAR, Channel 1	201
PAR, Channel 2	202
Rhodamine, µg/L	204
ODO, %Sat	211
ODO, mg/L	212
ODO, %Sat Local	214
TAL-PC, cells/mL	215
BGA-PC, RFU	216
TAL-PE, cells/mL	217

Parameter	Code
BGA-PE, RFU	218
Turbidity, FNU	223
Turbidity, Raw	224
BGA-PC, µg/L	225
BGA-PE, µg/L	226
fDOM, RFU	227
fDOM, QSU	228
Wiper Position, V	229
External Power, V	230
BGA-PC, Raw	231
BGA-PE, Raw	232
fDOM, Raw	233
Chlorophyll, Raw	234
Potassium, mV †	235
Potassium, mg/L †	236
nLF Conductivity, mS/cm	237
nLF Conductivity, µS/cm	238
Wiper Peak Current, mA	239
Vertical Position, m	240
Vertical Position, ft	241
Chlorophyll, cells/mL	242

† **NOTE:** Potassium is considered future functionality, there is currently no EXO probe for Potassium (as of 2020).

The subsequent values for the parameter map are displayed in IEEE floating point parameter format (IEEE 754). The Parameter data is stored in read only address 385-448. Two address are used for each value to make up the 32 bits required for a 4 byte IEEE floating point number. The value in address pair 385:386 corresponds to the parameter type in register 129, etc.

In our example let's assume the following values:

Temp 25.11°C, Turbidity 2.34 FNU, SpCond 3.02 ms/cm, pH 7.23, and Depth 1.45 M

Read Holding Address	Read Holding Register	Read/Write	Value (IEEE 754)	Description
384	385	Read	0xE147	The least significant 16 bits of the 32-bit floating point value for 25.11
385	386	Read	0x41C8	The most significant 16 bits of the 32-bit floating point value for 25.11
386	387	Read	0x47AE	The least significant 16 bits of the 32-bit floating point value for 3.02
387	388	Read	0x4041	The most significant 16 bits of the 32-bit floating point value for 3.02
388	389	Read	0x5C29	The least significant 16 bits of the 32-bit floating point value for 7.23
389	390	Read	0x40E7	The most significant 16 bits of the 32-bit floating point value for 7.23

Advanced Configuration

The 599825 Modbus adapter will automatically sleep after 60 seconds of not being queried. To prevent the adapter from sleeping, query the adapter more frequently than 60 seconds. Alternatively program a sample interval into register 1. This is the interval the 599825 Modbus adapter will refresh its readings from the underwater sonde. It can be advantageous to sample at a 10 or 15 minute interval to extend the life of the sensors.

As an example a 10 minute (600 second) sample value in register 1 will query the sonde every 10 minutes to refresh the values in 385-448 IEEE floating point registers. It is recommended you program a sample interval into the 599825 Modbus adapter half that of your scan interval. As an example if your SCADA will query the adapter every 20 minutes (1200 seconds) then it is recommended you write a 10 minute (600 seconds) sample value in address 1. This methodology will ensure the queried data is never more than 10 minutes old.

Activating the wiper: The EXO2/3 system is likely equipped with an central wiper to clean the sensors. There are two different mechanisms to activate the wiper.

The first is to write any number into register #3, this will trigger the EXO sonde to wipe the sensors in both directions. 60 seconds should be allocated for the wiping to complete, and the data presented to the Modbus holding registers during the wiping sequence will not be representative of the water quality because of the effects of the wiper passing over the sensors. It may be helpful to program a routine wipe interval into the SCADA system as well as an operator button to manually trigger the wipe sequence.

The second method is to program the sonde to autonomously sample at an interval that is greater than every two minutes. By default the sonde will wipe all the sensors before taking a reading. So programming a 1 hour deployment in the KorEXO software the sonde will automatically wipe the sensors. Note the real time data presented over Modbus during the wiping sequence will not be representative of the water quality because of the effects of the wiper passing over the sensors. This methodology will generate a redundant set of data internal to the sonde to compliment the data presented to the SCADA system.

➤ Scaled Integer Range Table

Parameter	Code	Scale Low	Scale High
Temperature, °C	1	-50	605.35
Temperature, °F	2	-50	605.35
Temperature, °K	3	0	655.35
Conductivity, mS/cm	4	0	655.35
Conductivity, µS/cm	5	0	65535
Specific Conductance, mS/cm	6	0	655.35
Specific Conductance, µS/cm	7	0	65535
TDS, g/L	10	0	65.535
Salinity, PPT	12	0	65.535
pH, mV	17	-1638.4	1638.35
pH	18	-27.768	39.767
ORP, mV	19	-1638.4	1638.35
Pressure, psia	20	-50	605.35
Pressure, psig	21	-50	605.35
Depth, m	22	-50	605.35
Depth, ft	23	-50	605.35
Battery, V	28	0	65.535
Turbidity, NTU	37	0	6553.5
NH3 (Ammonia), mg/L	47	0	655.35
NH4 (Ammonium), mg/L	48	0	655.35
Date, DDMMYY	51	N/A	N/A
Date, MMDDYY	52	N/A	N/A
Date, YYMMDD,	53	N/A	N/A
Time, HHMMSS	54	N/A	N/A
TDS, kg/L	95	0	65.535
NO3 (Nitrate), mV	101	-1638.4	1638.35
NO3 (Nitrate), mg/L	106	0	655.35
NH4 (Ammonium), mV	108	-1638.4	1638.35
TDS, mg/L	110	0	65535
Chloride, mg/L	112	0	655.35

Parameter	Code	Scale Low	Scale High
Chloride, mV	145	-1638.4	1638.35
TSS, mg/L	190	0	6553.5
TSS, g/L	191	0	6.5535
Chlorophyll, µg/L	193	0	655.35
Chlorophyll, RFU	194	0	655.35
Rhodamine, µg/L	204	0	6553.5
ODO, %Sat	211	0	655.35
ODO, mg/L	212	0	65.535
ODO, %Sat Local	214	0	655.35
BGA-PC, RFU	216	0	655.35
BGA-PE, RFU	218	0	655.35
Turbidity, FNU	223	0	6553.5
Turbidity, Raw	224	0	655.35
BGA-PC, µg/L	225	0	655.35
BGA-PE, µg/L	226	0	655.35
fDOM, RFU	227	0	655.35
fDOM, QSU	228	0	655.35
Wiper Position, V	229	0	65.535
External Power, V	230	0	65.535
BGA-PC, Raw	231	0	655.35
BGA-PE, Raw	232	0	655.35
fDOM, Raw	233	0	655.35
Chlorophyll, Raw	234	0	655.35
nLF Conductivity, mS/cm	237	0	655.35
nLF Conductivity, µS/cm	238	0	65535
Wiper Peak Current, mA	239	0	65.535
Vertical Position, m	240	-50	605.35
Vertical Position, ft	241	-50	605.35

2.16 Connect Sonde Flow Cell

There are two versions of the EXO flow cell: EXO1 flow cell (599080) and EXO2 / EXO3 flow cell (599201). Flow rate through the flow cell is typically between 100 mL and 1 L per minute. Maximum flow rate depends on tubing type, size, and length. Maximum pressure for each flow cell is 25 psi. Flow cell volumes (without sensors installed) are approximately 410 mL for EXO1, and 925 mL for EXO2 and EXO3.

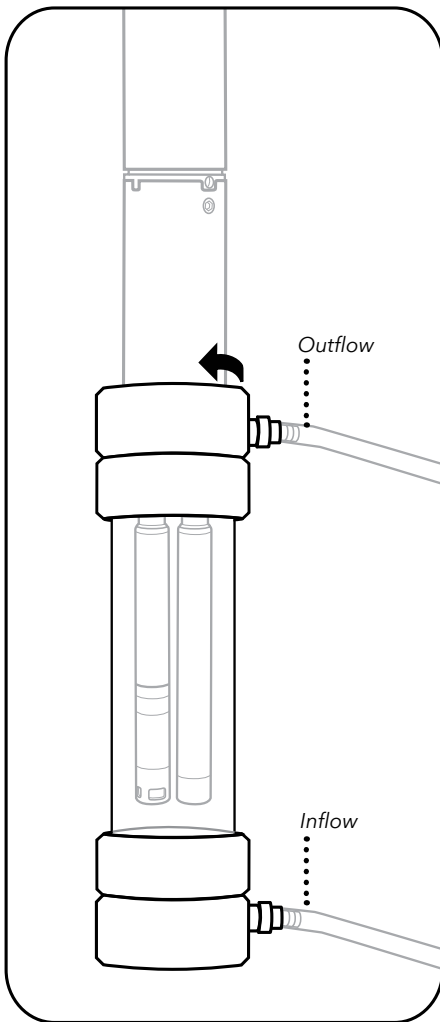

1 Inspect sonde and flow cell

Remove the sensor guard and/or calibration cup so that the sensors are exposed.

Make sure that the threads of the sonde and flow cell as well as all o-rings are clean and free of any particles such as sand, grit, or dirt.

2 Insert sonde into flow cell

Insert the sonde into the top of the flow cell. Be careful not to bump or scrape the sensors on the sides of the flow cell.

Screw the sonde into the flow cell by turning the sonde clockwise until it is hand-tightened into place; do not use a tool.

3 Connect tubing to flow cell

Install the Quick Connect tube fittings onto the flow cell by inserting them into the Quick Connect coupling body. They should snap into place.

Connect the tubing from your pump (not included) to the Quick Connect tube fittings, making sure that the tubing is pushed securely onto the fittings. The inflow should be at the bottom of the flow cell and the outflow should be at the top.

Keep flow cell vertical to purge it and ensure air release from Conductivity/ Temperature sensor.

NOTICE: Do not turn on water to the system *until* the flow cell is securely connected.

2.17 Daisy Chaining Sonde Expansion

It is possible to daisy chain up to three EXO2 sondes using the built-in topside auxiliary port. Below is a quick start guide for setting up sondes for long-term deployment in this application.

NOTE: *Daisy chaining is only possible with EXO2 sondes.*

NOTE: *These instructions are for the DCP-SOA 1.0. With the new 2.0 model, you no longer have to be this meticulous about the order in which you connect the instruments. Simply hook all the components together and then use the magnetic activation on the side of the DCP-SOA 2.0 to allow it to reset and rebuild the map.*

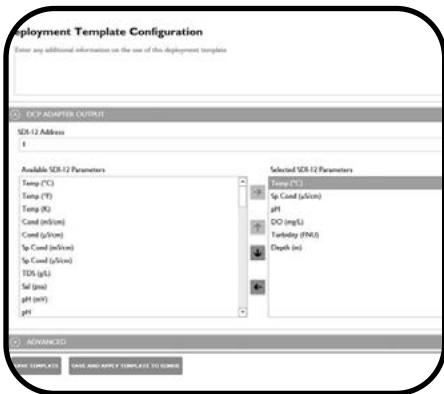

1 Set Deployment Times

Connect to each sonde individually via KorEXO. One by one, use the Deploy menu to Read Current Sonde Settings and make changes to the deployment templates. If using SDI-12 communications (recommended), set each sonde with a unique SDI-12 address.

2 Connect the Sondes

Remove power from the DCP adapter and remove all batteries from the instruments, then connect the 2-3 sondes in series using standard EXO field cables (connecting one sonde's communications connector with another sonde's topside auxiliary port).

NOTE: *Total cable length cannot exceed 300m, and the sondes themselves cannot exceed 250m depth.*

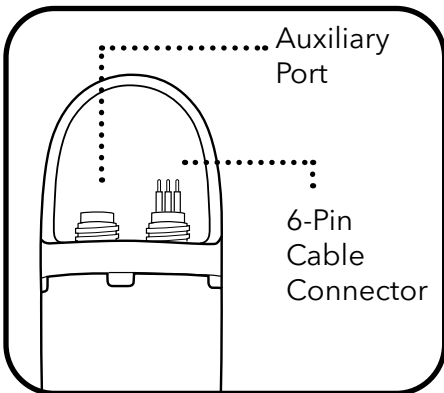

3 Connect Sondes to SOA-DCP

Using a flying lead cable, connect the topmost sonde to an EXO DCP Signal Output Adapter. Install batteries in the sonde furthest from the DCP adapter first. Then install batteries in the next sonde furthest from the adapter and then the sonde closest to the adapter if there are three sondes attached. Make sure the installed batteries are new and have around 6.0 volts supplied.

The final step is to apply power to the DCP adapter.



4 Test the System

Once the batteries have been installed and power has been supplied to the DCP adapter - use the SDI-12/RS232 commands in [Section 2.13](#) and [2.14](#), communicate with each daisy chained sonde to ensure data is collected.

NOTE: *Deploy the daisy chained system with a support cable connected to the bail of each sonde. If any changes are made to the configuration of the setup, the DCP adapter will need to be power cycled so the changes will take effect.*

2.18 Sonde Clamping / Mooring

Long-Term Monitoring

In long-term monitoring applications, where the sonde will be left unattended for long periods of time, it is critical that you properly mount and protect your EXO sonde. This will ensure you receive quality data and that your instrument is not lost in a flood or other natural event. While there are many options available to you to secure your sonde for long-term monitoring, including mooring cages and protective housing, below you will find a general guide for the most common method - the deployment tube.

Vertical Deployment Tube

The most common configuration for a deployment tube, typically off a pier or other fixed location. Highly recommended for the highest quality data as it ensures a proper flow of water to the sensors, and avoids stagnation.

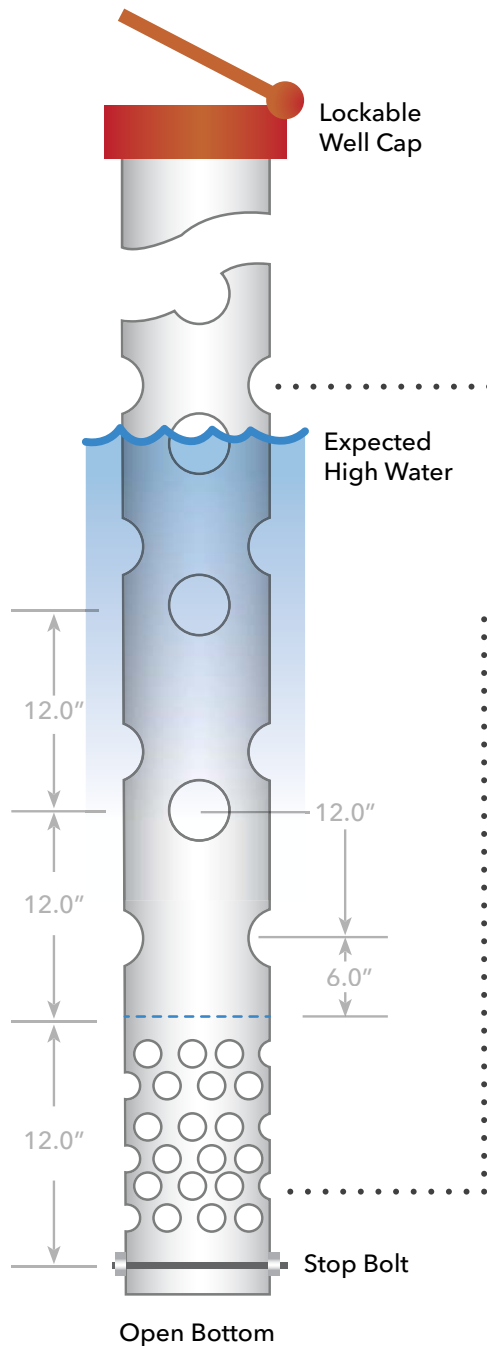

MATERIALS

- SCH 40 or SCH 80 - 4" PVC Pipe
- 1/2" SS Bolt, 6" Long
- 1/2" Flat Washers, Lock and Nut
- 4" Lockable Well Cap, Plastic or Aluminum
- 5200 Marine Sealant (for bonding pipe to cap)

INSTRUCTIONS

Vent or tube flushing hole pattern:
2.5" internal diameter.

Start one set 6" from end or top of sensor holes. Drill two holes at 0° and 180°. Start second set of two holes at 12" from sensor holes, drill at 90° and 270°.

Sensor area hole pattern:

Starting 1.0" above the stop bolt, drill 1.0" internal diameter holes around the entire sensor area. Should resemble Swiss-cheese. This allows for maximum flow of water to the sensors.



Mounted to Pier

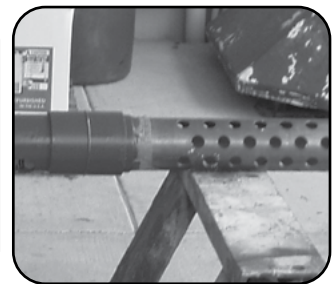

Copper Design

NOTES

- Clean and degrease pipe prior to modifications
- In marine and other fouling sites paint inside and out with anti-fouling paint
- Clean pipe at least twice a year

Horizontal Deployment Tube

In shallow water applications it is possible to deploy your EXO sonde horizontally. However, care must be taken that the sensors stay submerged and hydrated. This configuration has inherent risks such as sediment build up and is somewhat susceptible to flooding events even when properly fixed in place.

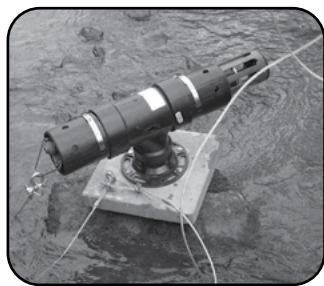
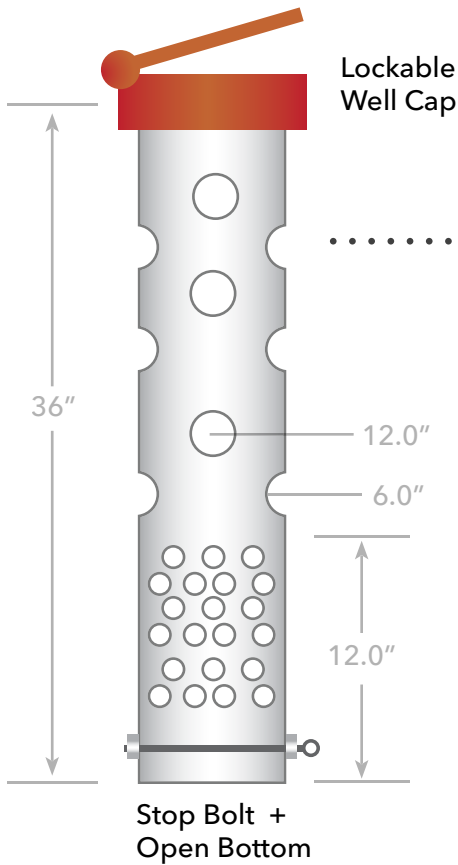

Shows exposed sensors. No debris deployments only.

MATERIALS

- SCH 40 or SCH 80 - 4" PVC Pipe, 36" Long
- 1/2" SS Bolt or Eye Bolt, 6" Long
- 1/2" Flat Washers, Lock and Nut
- 4" Lockable Well Cap, Plastic or Aluminum
- 5200 Marine Sealant (for bonding pipe to cap)
- Two heavy weighted slabs to support pipe

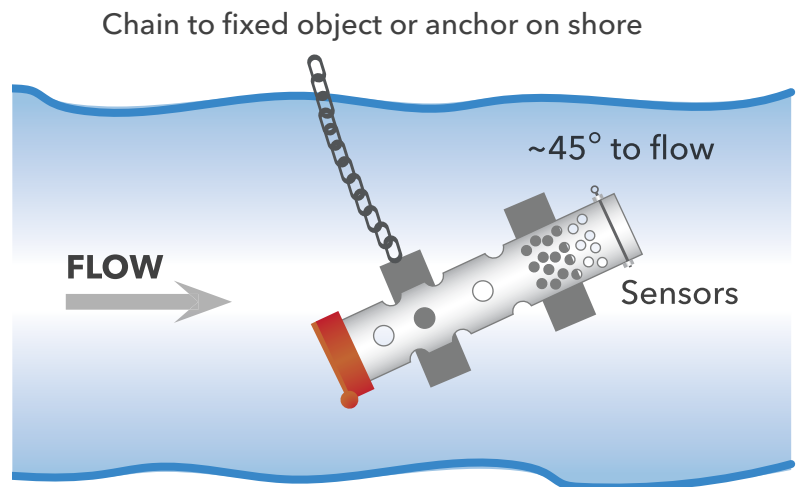

INSTRUCTIONS

Vent or tube flushing hole pattern:
2.5" internal diameter.

Drill one set of two, starting 6" from sensor holes at 0° and 180°. Drill second set of two 12" holes upwards at 90° and 270°.

Sensor area hole pattern:

1.0" internal diameter, 1.5" on centers 12" area from 1" above stop bolt.

NOTES

- PVC pipe must be firmly secured to its base or mount to prevent loss in high flows
- Mount and pipe should be treated with anti-fouling paint if in fouling environment
- Secure submerged parts to shore with chain or SS wire rope to a fixed object
- Never clamp sonde directly to mount

Sonde Clamping Guide

Great care should be taken when securing an EXO sonde to other objects. The preference is to deploy the sonde inside of a PVC pipe without clamps as described previously. However, if clamping is desired, the sonde should never be mounted directly to a mooring line, steel cable or piling as the pressure from a band clamp will deform the sonde and potentially cause leaks.

NOTICE: Damage and leaks from improper clamping is not covered under warranty.

Preferred Clamping Areas

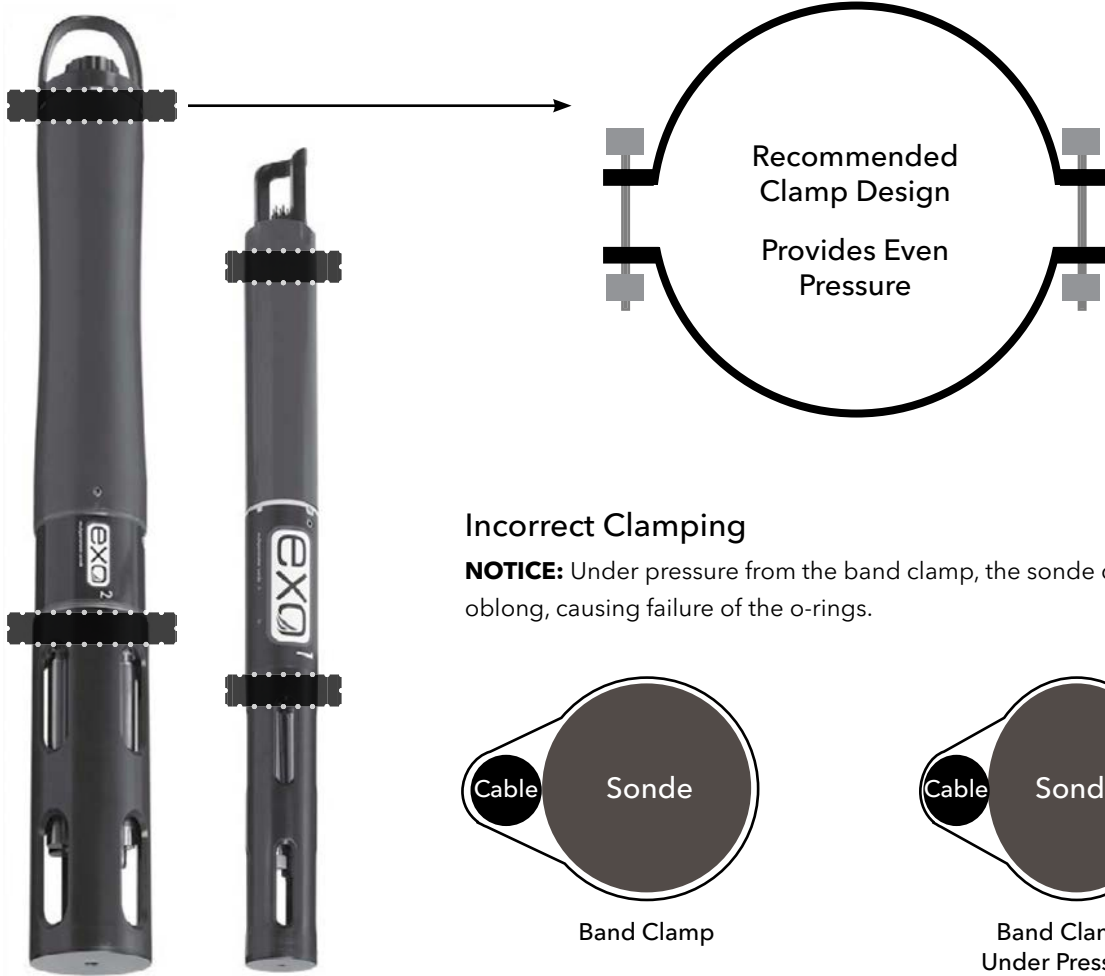

Mooring Cages

Some users prefer to house their Sonde in a protective mooring cage for their application.

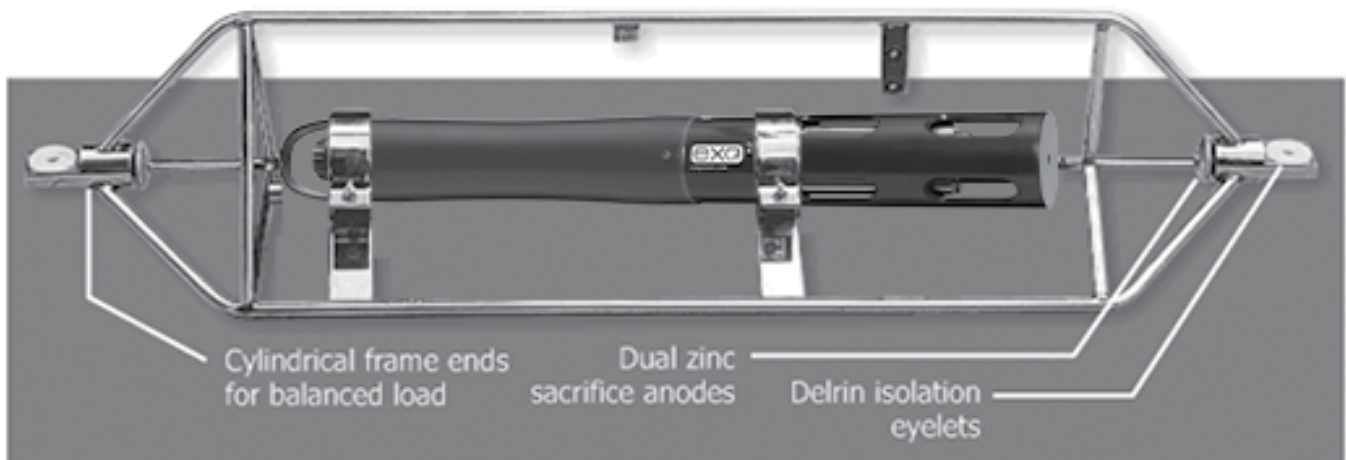



KorTM

Section 3 **KorEXO Software**

3.1

KorEXO Software Introduction

KorEXO Software and drivers require permissions for successful installation. Administrative privileges may be necessary for a business or networked PC.

System Requirements

Supported 32 bit (x86) and 64 bit (x64) Microsoft Operating Systems:

- Microsoft Windows 7 Home Basic SP1
- Microsoft Windows 7 Home Premium SP1
- Microsoft Windows 7 Professional SP1
- Microsoft Windows 7 Enterprise SP1
- Microsoft Windows 7 Ultimate SP1
- Microsoft Windows 8 Home Basic
- Microsoft Windows 8 Home Premium
- Microsoft Windows 8 Professional
- Microsoft Windows 8 Enterprise
- Microsoft Windows 8.1 Basic
- Microsoft Windows 8.1 Professional
- Microsoft Windows 8.1 Enterprise
- Microsoft Windows 10 Home
- Microsoft Windows 10 Professional
- Microsoft Windows 10 Enterprise
- Microsoft Windows 10 Education

Ram Memory Requirement:

- Minimum of 2 GB of RAM installed

Hard Disk Free Space:

- Minimum of 500 MB of free hard drive space

Screen Resolution:

- 1024x768 or higher

Internet access is required to support software and device updates. For any questions or concerns related to the installation or operation of KorEXO Software, please contact Technical Support at info@ysi.com.

3.2

KorEXO Software Installation

KorEXO Software is supplied with all EXO Sondes on a USB flash drive. Installation will require administrative privileges.

NOTE: It is important to install KorEXO Software prior to connecting EXO hardware, as the required drivers are installed along with the software.

Follow these steps to complete the installation process:

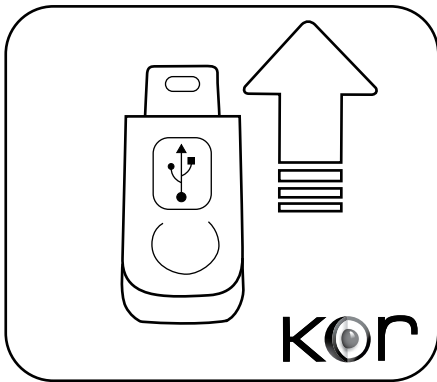

1. Insert the supplied USB flash drive into a USB port on your computer.
2. Double-click Start.exe in the EXO DRIVE window to launch the Installer.
3. Click INSTALL DRIVERS and click INSTALL ALL to install all EXO hardware drivers. Follow the prompts to complete each driver installation.
NOTE: Administrative Privileges are needed to perform each driver installation.
4. After drivers are installed, click BACK to return to the KorEXO Installer main menu.
5. Click INSTALL APPLICATION and check the box to agree to license terms and conditions, and then click INSTALL.
NOTE: Administrative Privileges are needed to perform the software installation.
6. After successful install, close the Installer.
7. Open the KorEXO Software program for the first time. You may be asked if you want to allow a program from an unknown publisher to make changes on the computer. If so, select YES.
NOTE: Administrative Privileges may be needed to run KorEXO Software for the first time; Administrative Privileges will not be needed for subsequent launches of the software.

Installation Troubleshooting:

Issue - Software Crash	Solution
This is the first time KorEXO has been installed on this PC and the software crashes the first time you open it.	Contact your IT Department or obtain read/write permissions to C:\ProgramData\YSI

3.3

KorEXO Software Instrument Connection Panel

KorEXO Software connection to any EXO device is established through the Instrument Connection Panel. There are two types of connection:

- Wired via USB cable
- Wireless via *Bluetooth* (not available for EXO Handheld)

Wired Connection:

There are a few ways to establish a wired connection to an EXO Sonde. The most common method involves using a USB Signal Output Adapter (SOA) which plugs into the sonde directly. Alternatively, one can use the EXO Handheld or the EXO GO which connects to the sonde via a field cable and connects to the computer via a USB cable. The following instructions pertain to connection via the USB SOA:

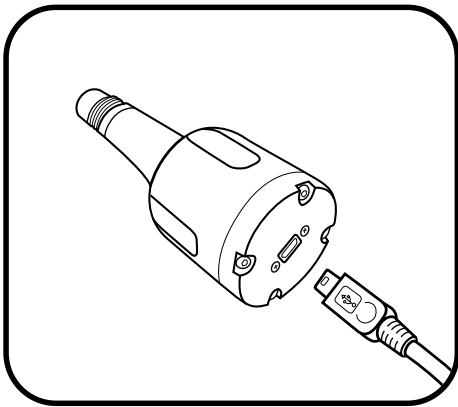

1 Connect the USB Cable to the Signal Output Adapter (SOA) and the PC

Remove the protective cap from the USB end of the SOA, and ensure that the connector is clean and dry. Insert the Mini USB end of the cable into the SOA connector and the USB A end of the cable into one of the PC's USB ports. The sonde should not be connected at this time.

Attaching the adapter to the PC causes a new device to be recognized. Windows automatically installs the drivers and creates a new COM port. Each new adapter that is attached creates a new COM port. To confirm that the SOA is successfully recognized as a COM port, open the Device Manager on the PC and view it under Ports.

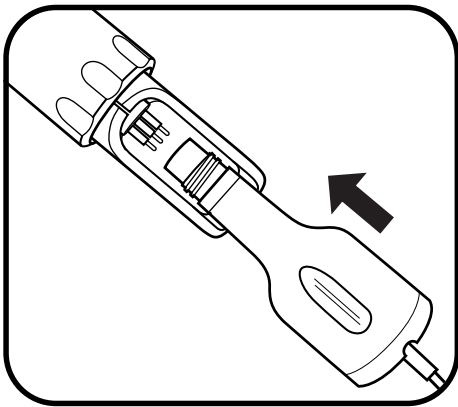

2 Connect the SOA to the EXO Sonde

Remove the plug from the male 6-pin connector on the sonde. Apply a light layer of Krytox grease to the male pins on the sonde and the female connector on the USB-SOA. Then align the connector's six pins and jackets, and press them firmly together so that no gap remains.

3 Open KorEXO Software

The PC connection via the SOA will supply power to the EXO Sonde; batteries are not required. Upon launching the software, the EXO Sonde should appear in the Instrument Connection Panel. Simply click the CONNECT button to establish communication with the sonde. An option to Automatically Connect to Instrument is available in the General Settings.

SOA Troubleshooting:

Issue - Cannot Find EXO Device	Solution
After you install the driver, the device shows up as "USB Serial Device" or with an exclamation point in Device Manager.	Run the installer as an administrator by right clicking on "Start.exe" and choosing "Run as Administrator."

Wireless Connection:

Every EXO Sonde includes a built-in *Bluetooth* chip which allows for wireless communication with a computer that has BT capabilities. This is extremely convenient for calibration and sampling at the surface level. However, the *Bluetooth* communication is severed when the sonde is submerged under water. The EXO GO adapter provides a *Bluetooth* connection to an EXO Sonde that may be submerged. The following instructions pertain to connection via the EXO Sonde's internal *Bluetooth*.

NOTE: To wirelessly connect to an EXO Sonde, your computer must either have internal *Bluetooth* or a *USB Bluetooth dongle*.

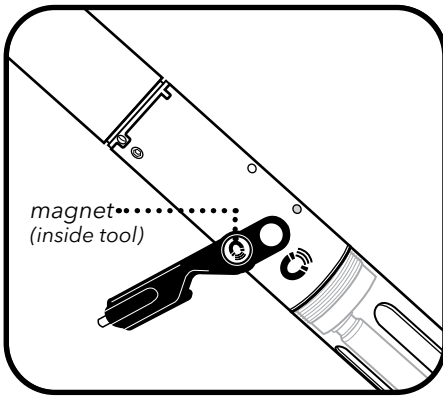

1 Activate the Sonde's *Bluetooth*

Tap a magnet on the designated icon on the EXO Sonde to awaken and activate *Bluetooth*. A magnet is built into the probe installation/removal tool with a matching icon. If no magnet is available, you may cycle power to the sonde by removing the batteries and reinstalling them to awaken and activate *Bluetooth*.

A blue LED will illuminate continuously for up to 5 minutes to indicate that *Bluetooth* is active and the sonde is discoverable. Once a link has been established with KorEXO Software, the blue LED blinks at 2 Hz to indicate the sonde is communicating.

An alternative to using the EXO Sonde's built-in *Bluetooth* is using the EXO GO communication adapter. Simply connect the EXO GO to the sonde using a field cable, power on the EXO GO which activates its own *Bluetooth*, and proceed to scan for it using KorEXO Software.



2 Scan for *Bluetooth* Device

Using KorEXO Software, click the SCAN FOR BLUETOOTH DEVICES button in the Instrument Connection Panel. This might need to be repeated several times before the software finds the sonde. Once the EXO Sonde appears, simply click the CONNECT button to establish communication. An option to Automatically Connect to Instrument is available in the General Settings.

Upon connection, the KorEXO Software will automatically check the SmartQC Score of the sonde. Also, depending on software settings, data may automatically start downloading; otherwise, data may be manually downloaded by clicking START DOWNLOAD FROM DEVICE.

3.4

KorEXO Software Home Screen

The KorEXO Home screen provides quick access to the most common functions of the software and links to helpful pages on YSI.com.

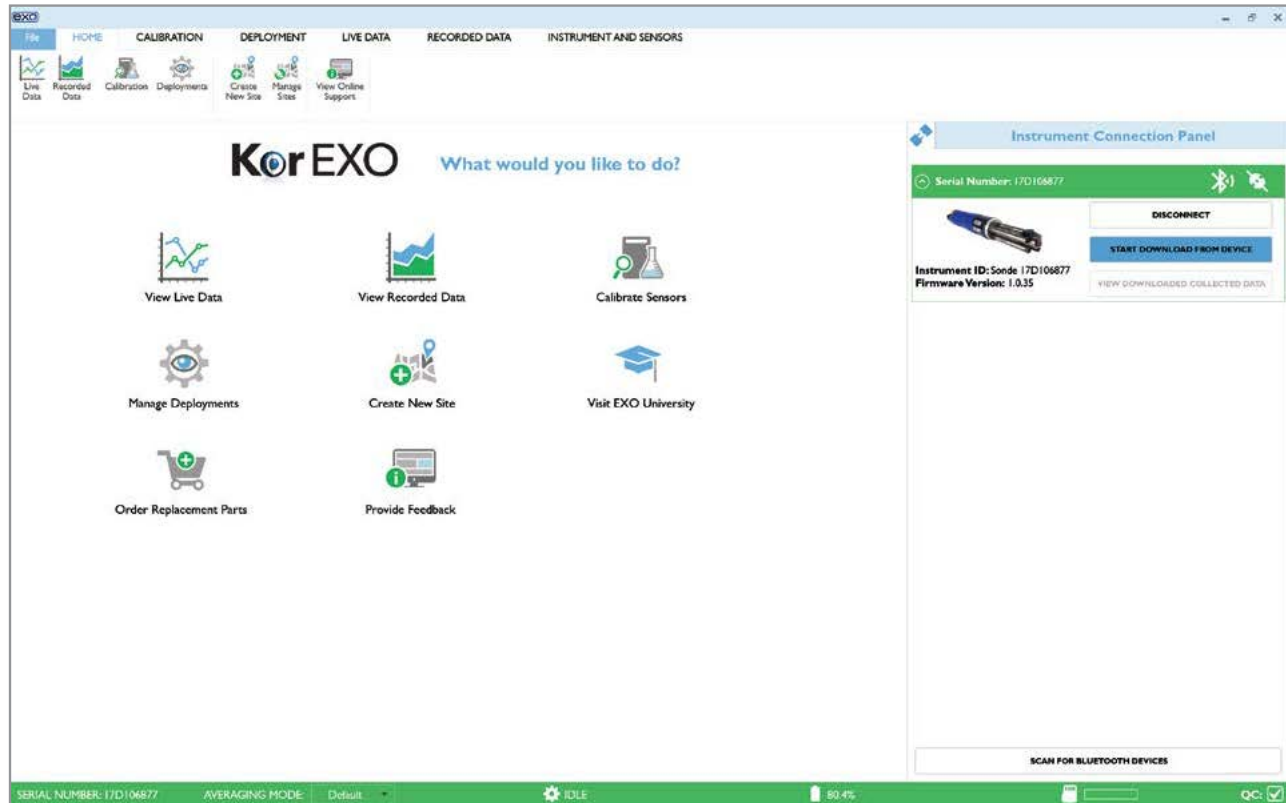

Instrument Connection Panel - Displays any EXO hardware that is connected or available for connection.

View Live Data - Navigates to the Dashboard with live readings from the sonde. These measurements may be saved locally to the software database. An EXO must be connected to see data.

View Recorded Data - Navigates to the Recorded Data screen where users can access the database to find measurement data files that have been captured from the Live Data screen or downloaded from the EXO Sonde or EXO Handheld.

Calibrate Sensors - Navigates to the Calibration screen with a list of available sensors to calibrate. An EXO must be connected to perform a calibration. Users can also view and export calibration records from this screen.

Manage Deployments - Navigates to the Deployment screen which displays deployment settings for the connected EXO Sonde. Users can edit the sonde's deployment settings and deploy the sonde. An EXO must be connected to view its settings and start a deployment. Users may also view and create deployment templates and sites from this screen.

Create New Site - Allows users to create a new site which can be saved locally to the software.

Visit EXO University - Navigates to the EXO University channel on YSI.com. An internet connection is required to access this site.

Order Replacement Parts - Navigates to the YSI.com webstore. An internet connection is required to access this site.

Provide Feedback - Navigates to an online form to provide software feedback. An internet connection is required to access this site.

Menus

The top of the software screen is home to several menu options:

- **FILE**
- **HOME**
- **CALIBRATION**
- **DEPLOYMENT**
- **LIVE DATA**
- **RECORDED DATA**
- **INSTRUMENT AND SENSORS**

Ribbon



A ribbon resides below the menu bar which contains options unique to the menu that is selected. For example, the ribbon on the calibration screen includes options to find, export, and print calibration records. Users may choose to hide the ribbon from view or keep it open as they navigate the software.

Status Bar



The status bar displays important information about the connected EXO Sonde.

- Instrument Serial Number
- Averaging Mode - Select from drop-down list
 - Default = Normal Averaging
 - Accelerated = Faster Averaging
 - Rapid = Fastest Averaging
- Deployment Status - Idle (not logging) or Deployed (logging or scheduled to log)
- Battery Percentage
- Free Memory
- QC Score (see [Section 4.4](#) for more information on SmartQC) - Clicking the QC Score will take you to the INSTRUMENT AND SENSORS screen.

3.5

KorEXO Software

File Menu

The File Menu allows users to view software information and adjust software-specific settings.

- Import
- Settings
- About
- Exit

Import

Users can import various files transferred from version 1.0.X of KorEXO Software or from other instances of KorEXO version 2.X installed on different computers. These files may be transferred remotely through email or manually using a USB flash drive. Take note of which folder the file is transferred to on the computer.

IMPORT CALIBRATION - Allows users to import calibration files from another instance of KorEXO Software. Compatible files will have the ".cal or .xml" extension.

IMPORT DEPLOYMENT - Allows users to import deployment templates from another instance of KorEXO Software. Compatible files will have the ".dep or .xml" extension.

IMPORT EXO BINARY FILE - Allows users to import data files from another instance of KorEXO Software. Compatible files will have the ".bin" extension.

IMPORT SITE - Allows users to import sites created from an older version (1.0.X) of KorEXO Software. Compatible files will have the ".sit" extension.

Settings

Users can adjust general settings related to the software as well as parameter specific settings. It is important to note that these settings are saved locally and only pertain to the software itself. These settings are not pushed to any EXO devices nor are they carried over to instances of KorEXO Software installed on other computers.

General Settings

AUTOMATION SETTINGS

- Automatically Update Software and Firmware - Toggle On/Off
The software will indicate if there is an update available in the File menu. An internet connection is required to check for software and firmware updates.
- Automatically Connect to Instrument - Toggle On/Off
The EXO device will automatically connect as soon as it is discovered by the Instrument Connection Panel.
- Automatically Download Data from Instrument to PC - Toggle On/Off
Upon connection to the EXO device, it will automatically download any new data that has been collected since it was last connected to the software.
- Automatically Update Instrument Time to PC Time - Toggle On/Off
The software will update the EXO clock to sync with the PC time.

FILE EXPORT

- CSV Delimiting Character - Select from drop-down list

The delimiting character represents a boundary and acts to separate data in a CSV file. The default option is a comma ',' but some users may prefer a period '.' or Tab as the delimiter.

- CSV Export Type - Select from drop-down list

There are two options for the CSV export of a measurement file:

- With Header - Includes a section for mean values and standard deviation for every column of measurement data. Additionally, detailed parameter names are included as well as a dedicated row for sensor serial numbers.
- Without Header - A simplified view where the top row of the spreadsheet features column labels with the respective data in the rows that follow. Parameter names are shortened and occupy the same cell as their respective sensor serial number.

STARTUP OPTIONS

- Require User Login - Toggle On/Off

This requires the user to select a User Name when the software is launched. The selected User Name will be the default ID tagged to any data captured in the Live Data screen and any calibration that is performed. The User Name can be switched at any time without having to exit or restart the software.

LANGUAGE SETTINGS

- Select Language - Select from drop-down list

Available languages include:

- Chinese (Simplified)
 - Chinese (Traditional)
 - English (United States)
 - English (United Kingdom)
 - French
 - German
 - Italian
 - Japanese
 - Korean
 - Norse
 - Portuguese
 - Spanish (Spain)
 - Spanish (Americas)
 - Vietnamese
- Override Regional Settings - Select radio button

There are two options for regional settings:

Use Selected Language Regional Settings - Sets the regional settings based on the language selected in KorEXO Software.

Use Local OS Regional Settings - Matches the regional settings to the computer's local operating system.

Parameter Settings

Parameter-specific display preferences are found in the Settings menu. This is where users can enable or disable parameters and select the units of measure for display in Live Data view and Recorded Data view. Note that these settings are saved locally to KorEXO Software and do not change sensor hardware settings.

Available Parameter Settings Include

Display Settings	Parameter	Unit
Algae	Phycocyanin	RFU
		µg/L
		cells/mL (requires user input)
	Phycoerythrin	RFU
		µg/L
		cells/mL (requires user input)
Barometer	Barometer	mmHg
		mbars
		inHg
		psi
		kPa
		Atm
Conductivity	Conductivity	µS/cm
		mS/cm
	Specific Conductivity	µS/cm
		mS/cm
	Resistivity	ohms-cm
		kohms-cm
		mohms-cm
	TDS (Total Dissolved Solids)	mg/L
		g/L
		kg/L
	Salinity	psu
		ppt
NLF Conductivity	µS/cm	
	mS/cm	
Water Density	σ	
	σ t	
Chlorophyll	Chlorophyll	RFU
		µg/L
		cells/mL (requires user input)
Depth	Depth	m
		ft
	Vertical Position	m
		ft
	Absolute Pressure	psi a
		bar a
	Gage Pressure	psi g
		bar g

(continued)

Display Settings	Parameter	Unit
DO	Dissolved Oxygen	% Sat
		mg/L
		% Local
		% LocalB
fDOM	fDOM	QSU
		ppb
		RFU
GPS	GPS	Decimal Degrees
		Altitude
		m ft
ISE	NH4+ -N (Ammonium)	mg/L
		mV
	NH3 (Ammonia)	mg/L
		NO3 -N (Nitrate)
	CL- (Chloride)	mg/L
		mV
ORP	ORP	mV
PAR	PAR Channel 1	$\mu\text{mol}\cdot\text{s}^{-1}\cdot\text{m}^{-2}$ (requires user input)
	PAR Channel 2	$\mu\text{mol}\cdot\text{s}^{-1}\cdot\text{m}^{-2}$ (requires user input)
pH	pH	pH
		mV
Rhodamine WT	Rhodamine WT	$\mu\text{g}/\text{L}$
		ppb
		RFU
Sonde	Cable Power	volt
	Battery Voltage	volt
Temperature	Temperature	$^{\circ}\text{C}$
		$^{\circ}\text{F}$
		K
Turbidity	Turbidity	FNU
		NTU
		mg/L (requires user input)
		g/L (requires user input)
Wiper	Wiper Position	volt

About

Users can view software version information as well as phone, email, and online support information. A status notification will be displayed that indicates whether or not there is an update available.

Exit

This will close the software.

3.6

KorEXO Software Calibration Screen

The calibration screen is where users calibrate EXO sensors, view calibration records, and set calibration reminders. This section will explain the calibration options and settings. Information related to calibration methods for a specific parameter calibration can be found in [Section 4](#).



Calibrate

This displays a list of parameters that available to calibrate. The parameters are organized under each respective sensor. Every parameter has two options:

- 1. CALIBRATE** - Select this to perform a user calibration.
- 2. FACTORY RESET CALIBRATION** - Select this to restore the factory default calibration. Note this deletes the user calibrations from the sensor and reverts to the original factory settings. A user calibration must be performed after the factory reset.

Find Calibration Records

<input type="checkbox"/>	SENSOR TYPE	PARAMETER	SENSOR SERIAL NUMBER	CALIBRATION DATE	SONDE SERIA
No results					

This opens the calibration records database where users can filter and find previous calibration records. A calibration record is generated and stored every time a parameter is calibrated. Multiple calibration records may be selected to view simultaneously.

Selected records are listed under the Calibration Records Panel. These records are sorted by calibration date and organized by sensor on the left side of the screen. Select a specific record to view its calibration details displayed on the right side of the screen. See [Section 4.3](#) for more information on Calibration Records.

Export to CSV

Select this to save in a file format which can be opened in a spreadsheet (such as Excel).

Export to XML

Select this to save in file format which can be imported by another instance of KorEXO Software.

Print Records

Select this to print a calibration report for any record shown in the Calibration Records Panel.

Manage Sensor Reminders

NOTE: This feature is only available on the Premium license.

Reminders may be enabled or disabled for select parameters based on a predefined calibration interval. This interval may be adjusted by the user. Additionally, reminders may be set for the replacement of sensor modules and ODO caps.

These settings may affect the QC Score displayed by the software. For example, if the number of days since the last calibration is greater than the interval set, the software QC Score (SoftQC) will be red.

3.7

KorEXO Software Deployment Screen

The deployment screen is where users setup the sonde for unattended logging. The sonde log status and deployment information is displayed in the main window. Additionally, a ribbon menu includes options to create, edit, start, and stop a deployment. An EXO must be connected to view its settings and start a deployment.



Start & Stop Deployment

Click Start Deployment to begin logging at the present or a future time. Three options will be presented for Start Time:

- 1. NEXT INTERVAL** - Logging will begin at the next time interval as specified by the deployment template.
- 2. NOW** - Logging will begin immediately.
- 3. CUSTOM** - Logging will begin at a user-specified date and time.

Deployment Template

A deployment template includes all the settings necessary for the sonde to accomplish unattended logging. There are three options for creating or editing a template:

Create Template

Creates a new template from scratch.

Create Template from Sonde

Pulls the deployment settings from a connected EXO Sonde which can then be edited, saved, and reapplied to the sonde.

Open Template

Opens an existing template which can be edited, saved, and applied to a connected sonde.

Each template includes the BASIC, DCP ADAPTER OUTPUT, and ADVANCED settings.

BASIC DEPLOYMENT SETTINGS:

Deployment Template Configuration

BASIC DEPLOYMENT SETTINGS

Deployment Template Name:

Logging Interval Time:
hour(s) minute(s) second(s) ms

File Name Prefix:

Site Name: User Name:

Deployment Template Description (Optional)

Deployment Template Name - this is the name the template will be saved as

Logging Interval Time - this is how frequently the sonde will log data

File Name Prefix - this is the file name under which the logged data will be saved

Site Name - name of the location to be tagged with the logged data

User Name - name of the user to be tagged with the logged data

Deployment Template Description - any additional information users would like to reference for this template

DCP ADAPTER OUTPUT:

NOTE: This section is only applicable if the sonde will be communicating to an external device via SDI-12, RS-232, or Modbus protocol.

Deployment Template Configuration

Enter any additional information on the use of this deployment template

DCP ADAPTER OUTPUT

SDI-12 Address
0

Available SDI-12 Parameters

- Temp (°C)
- Temp (°F)
- Temp (K)
- Cond (mS/cm)
- Cond (µS/cm)
- Sp Cond (mS/cm)
- Sp Cond (µS/cm)
- TDS (g/L)
- Sal (psu)
- pH (mV)
- pH

Selected SDI-12 Parameters

ADVANCED

SAVE TEMPLATE SAVE AND APPLY TEMPLATE TO SONDE CANCEL

SDI-12 Address - address of the EXO Sonde

Available SDI-12 Parameters - all parameters available to select and organize

See [Section 2.14](#) for more information about SDI-12 communication.

ADVANCED:

There are several advanced settings which are optional for the deployment.

The screenshot displays the 'Deployment Template Configuration' window with the 'ADVANCED' tab selected. The settings are organized into several sections:

- Logging Mode:** A dropdown menu set to 'Normal'.
- Additional Averaging Duration:** Two input fields for 'minute(s)' and 'second(s)', both set to '0'.
- Burst Mode Duration:** Two input fields for 'minute(s)' and 'second(s)', both set to '0'.
- Samples per Wipe:** A text input field containing the value '1'. Below it, a note states: 'A wipe will occur every 0.02 minutes'.
- System-wide Averaging Mode:** A dropdown menu set to 'Default'.
- Adaptive Logging:** A toggle switch is turned on.
- Adaptive Logging Interval:** Four input fields for 'hour(s)', 'minute(s)', 'second(s)', and 'ms', with values '0', '0', '1', and '0' respectively.
- Adaptive Logging Duration:** Four input fields for 'hour(s)', 'minute(s)', 'second(s)', and 'ms', all set to '0'.
- Adaptive Logging 1 Mode:** A dropdown menu set to 'Off'.
- Adaptive Logging 2 Mode:** A dropdown menu set to 'Off'.
- Adaptive Logging 1 Parameter:** A dropdown menu set to 'Temp (°C)'.
- Adaptive Logging 2 Parameter:** A dropdown menu set to 'Temp (°C)'.
- Adaptive Logging 1 Threshold:** A text input field with a value of '0' and a '+'/- control.
- Adaptive Logging 2 Threshold:** A text input field with a value of '0' and a '+'/- control.

At the bottom of the window, there are three buttons: 'SAVE TEMPLATE', 'SAVE AND APPLY TEMPLATE TO SONDE', and 'CANCEL'.

Logging Mode:

Normal - The sonde will log readings based on the normal interval time specified in the BASIC settings.

Sample and Hold - This is designed to ensure that the data the sonde logs internally matches the data sent to a DCP.

Burst - The sonde will log a data point once a second for the given duration.

Burst Mode Duration - Specify the duration for Burst mode.

Additional Averaging Duration - The averaging setting will apply as the sonde logs a data point. For example, if 10 seconds is selected, then 10 '1-second' readings will be averaged to a single data point.

Samples per Wipe - Specify how many samples will be logged between the wipe interval.

System-wide Averaging Mode - Choose from three averaging modes:

1. DEFAULT - Select for continuous monitoring at a fixed site
2. ACCELERATED - Select for step profiling
3. RAPID - Select for advanced applications where the sonde is moving

See [Section 4.1](#) for more information on Averaging Modes.

Adaptive Logging:

Adaptive logging may be enabled to change the log interval time based on up to two user specified parameters and thresholds.

When the parameter reads above or below a specific threshold, the sonde begins to log at the Adaptive Logging Interval. When the parameter reading crosses back over the threshold, the sonde will return to its normal logging interval.

SAVE TEMPLATE - Saves the template locally to the software.

SAVE AND APPLY TEMPLATE TO SONDE - Saves the template locally to the software and applies the settings to the sonde.

Sites

Sites can be created to allow users to organize their data by custom Site Names. The site name will be tagged to any data logged while that site is active. A site can be active in a deployment (specified in the deployment template) and in the Live Data screen for sampling.

Create a New Site

Users can input a custom site name (required) and a site description (optional). The site creation date is auto-populated. Additional options include adding a site photo and adding up to ten custom fields. The site photo must be a 24-bit BMP file no larger than 240 pixels wide by 260 pixels tall.

Manage Sites:

Access a local site database to view, modify, or delete existing sites. This also allows users to import existing sites from an EXO Handheld.

3.8

KorEXO Software

Live & Recorded Data

Live Data

The Live Data screen display readings from a connected EXO Sonde. There are three options for viewing data on this screen:

DASHBOARD - The default, grid view of enabled parameter values which are refreshed at the specified time interval.

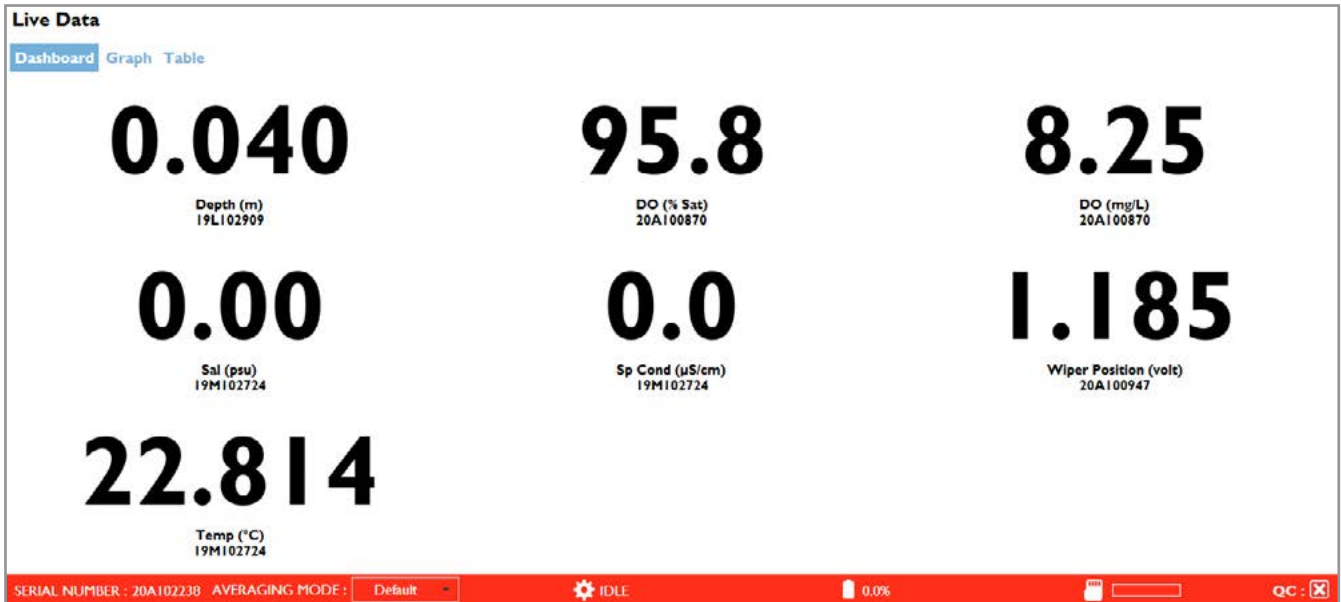

GRAPH - A time-based or depth-based graph view; each graph can display up to two parameters specified by the user.

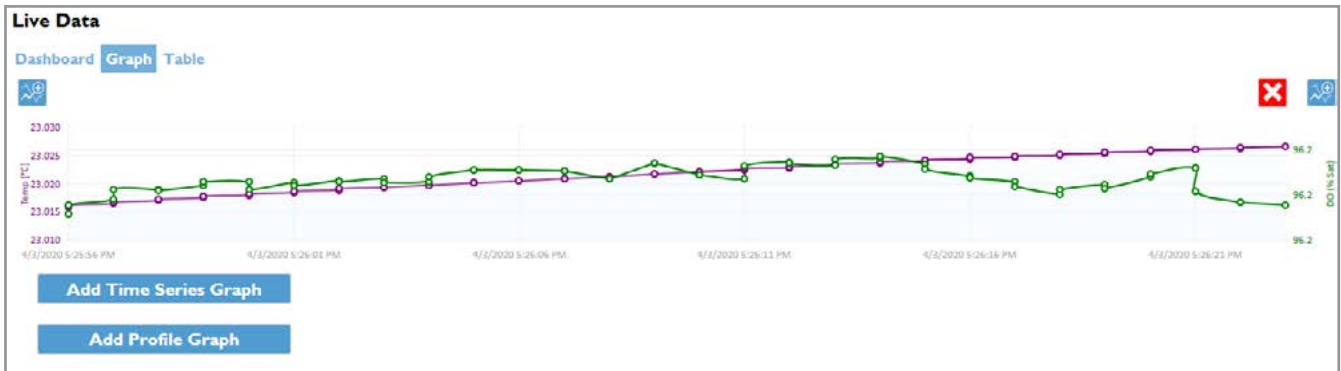
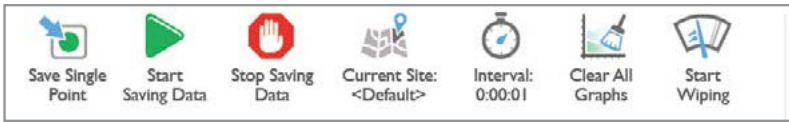

TABLE - A column based view where new rows of data are added to a list at the specified time interval.

Time	DATE	SITE NAME	DEPTH (M)	DO (% SAT)	DO (MG/L)	SAL (PSU)	SP COND (µS/CM)	WIPER POSITION (VOLT)	TEMP (°C)	FAULT CODE
5:25:56 PM	4/3/2020	Default	0.040	96.2	8.25	0.00	0.0	1.185	23.016	0
5:25:56 PM	4/3/2020	Default	0.040	96.2	8.25	0.00	0.0	1.185	23.016	0
5:25:57 PM	4/3/2020	Default	0.040	96.2	8.25	0.00	0.0	1.185	23.017	0
5:25:57 PM	4/3/2020	Default	0.040	96.2	8.25	0.00	0.0	1.185	23.017	0
5:25:58 PM	4/3/2020	Default	0.040	96.2	8.25	0.00	0.0	1.185	23.017	0
5:25:58 PM	4/3/2020	Default	0.040	96.2	8.25	0.00	0.0	1.185	23.017	0
5:25:59 PM	4/3/2020	Default	0.040	96.2	8.25	0.00	0.0	1.185	23.018	0



Save Single Point

Logs one data set at the time the button is pressed.

Start Saving Data

Logs continuously at the specified time interval.

Stop Saving Data

Stops the continuous logging.

Current Site

The active site that is tagged to the logged data.

Interval

The time interval in which data is refreshed and logged.

Clear All Graphs

Clears data from any open graphs.

Start Wiping

Activates the wiper on an EXO Sonde.

Recorded Data

The Recorded Data screen displays data files that have been logged in the software and/or downloaded from the EXO Sonde's internal memory. Users must first select the file(s) in the Search menu before data are displayed. Data can be viewed in Table or Graph view. Additionally, data can be exported or printed.

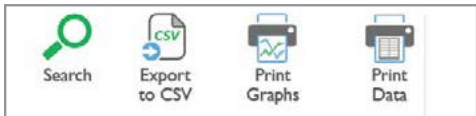

Search

Access and filter the software database to find logged data files; multiple files can be viewed simultaneously.

Export to CSV

Saves in a file format which can be opened in a spreadsheet (such as Excel).

Print Graphs

Prints a graph of the selected data.

Print Data

Prints a table of the selected data.

Select Data to View

Search

- RECENT DOWNLOADS
 - Recently Downloaded
- START DATE
 - 3/4/2020
- END DATE
 - Select a date
- DEVICE SERIAL NUMBER(S)
- SITE NAME
- INSTRUMENT ID
- FILE NAME
- USER ID
- PARAMETERS

Results

	START DATE	END DATE	INSTRUMENT	FILE NAME	DATA S
<input type="checkbox"/>	3/30/2020 7:34:01 PM	3/30/2020 7:34:01 PM	Sonde 20A1022	EXOSD_20A102238_033020_193401.t	1
<input type="checkbox"/>	3/30/2020 7:44:00 PM	3/30/2020 7:45:00 PM	Sonde 20A1022	EXOSD_20A102238_033020_194400.t	2

VIEW SELECTED RECORDED DATA CANCEL DELETE

3.9

KorEXO Software Instruments and Sensors

The INSTRUMENTS AND SENSORS screen allows users to view the status and edit settings for any connected EXO devices. EXO devices are listed with the host device at the top and the sensors below. Logged data files can be manually downloaded from the sonde or handheld. The QC Score of each EXO device is available to view. Simply click on the specific device to view details related to its QC Score (See [Section 4.4](#) for more information on SmartQC).



Update Instrument Firmware

Instrument firmware can be manually updated by clicking the Update icon in the ribbon.

NOTE: The latest firmware must be downloaded first. Check the File menu to see if there is an update available. An internet connection is required to check for updates.

Legacy Handheld

It is possible to communicate with the legacy EXO Handheld to manage calibration, site, deployment, and measurement records.

The screenshot displays the 'Device Status' window. On the left, the 'Overall SmartQC™ Score' is shown with a red 'X' icon. Below this, the 'Sonde' details are listed: Serial Number: 20A102238, Firmware Version: 1.0.83, Configuration: EXO2 - 6 port Sonde, and Disk Space Used. Three sensors are listed: 'Wiped Conductivity Sensor' (Bulkhead Port Number: 3, Serial Number: 19M102724, Firmware Version: 3.0.5), 'DO Sensor' (Bulkhead Port Number: 4, Serial Number: 20A100870, Firmware Version: 3.0.0), and 'Wiper Sensor' (Bulkhead Port Number: 7, Serial Number: 20A100947, Firmware Version: 3.0.0). On the right, the 'Sonde Settings' panel shows 'Sonde ID' as 20A102238 and 'Sonde Time' as Friday, April 03, 2020 5:43:36 PM. Below this, 'Sonde Used Space' is 0.01% and 'Sonde Averaging Mode' is set to Default. A table of 'Logged Measurement Files' is shown with columns for Start Date, File Name, File Size, Status, and Action. Two files are listed: one from 3/30/2020 7:34 PM (718 B, Imported) and another from 3/30/2020 7:44 PM (864 B, Imported). A 'DELETE RECORDS' button is located below the table. At the bottom right of the settings panel is an 'APPLY SENSOR SETTING' button. The bottom status bar shows 'SERIAL NUMBER : 20A102238', 'AVERAGING MODE : Default', 'IDLE' status, '0.0%' battery, and 'QC : X'.



Section 4

Sensors and Calibration

4.1

Sensors

Overview

The EXO product line includes sensors that detect a variety of physical, chemical, and biological properties of water. EXO sensors are designed to collect highly accurate data under ever-changing conditions.

Data Filtering

All EXO sensors share some common embedded software, including the filtering of real-time data. Sensors acquire environmental data at a constant rate, and use this stream of data as the input to the filtering algorithm that produces results seen by the user. EXO sondes collect data from the EXO sensors and are able to output data at rates up to 4 Hz.

Basic Rolling Filter

The filter is fundamentally a rolling or window average of past acquired inputs to the filter, such that as a new data value is added to the summation, the oldest data value is removed, and the total summation is divided by the total number of data values. It is a simple average, just rolling or moving in time. Starting with the February 2014 software release, different rolling time windows for the filter are now supported.

Averaging Modes

The Averaging Mode for EXO sensors can be modified by the user in the Deployment and Live Data settings in KorEXO Software and the EXO Handheld. Three Averaging options are available:

Default - This is the mode for all sensors set at the factory and provides optimum data filtering for most applications. It provides the highest accuracy, automatic averaging during unattended monitoring or fixed mooring. This mode has up to 40 seconds of filtering on the sensors.

Accelerated* - This mode should be used for spot sampling and slow (or paused) depth profiles. The sensors are averaging 5-10 seconds of data in a rolling window, unless there are any outliers.

Rapid* - This mode should be used where the sonde is moving quickly through the water, such as with rapid profiling and unique applications like AUV's, gliders, or towed applications. The data will be noisy and will never settle on a single steady number. This mode has 2-3 second filtering on the sensors.

*TIP: Enable the Vertical Position parameter in the Depth unit options to view the real-time position of the sonde in the water column. This is helpful in profiling applications to ensure the sonde is lowered to the desired depth without waiting for the Depth data to stabilize.

NOTE: *Making any changes to the Averaging Mode will stop a deployment. As a sonde takes measurements, it compares new readings to those taken in the previous 2-30 seconds (depending on the selected option). If the new reading is not significantly different than past measurements, then it merely factors into the rolling average with older data points to create a smooth curve. If the new reading is significantly different than past measurements, then it restarts the rolling average of data points.*

To quickly check a sonde's Averaging Mode setting in KorEXO Software, check the bottom status bar and the word Default, Accelerated, or Rapid will be displayed adjacent to the sonde's serial number. To access Averaging Mode with the handheld, press the Deploy button, select Sonde Settings, and then Averaging.

Adaptive Filtering

The drawback to a basic rolling filter is that response time to an impulse event is delayed, and the more entries in the average summation, the longer the delay for the result to converge on the true value. To correct this, the filter algorithm monitors the new data arriving and compares it to the current averaged result, looking for indication of an impulse event. When new data deviate from the average by more than a predetermined tolerance, the number of data entries within the rolling average is reduced to a minimum count and the remaining values are flushed with the new data. The result is a more accurate capture of the impulse event data, entirely eliminating the inherent delay caused by the rolling average.

Outlier Rejection

Every time a newly acquired data value is added, the rolling average entries are scanned for outlier data. Although such data has already been determined to fall within the tolerances defined above, the remaining worst offenders are removed from the rolling average calculation. This outlier rejection allows for smoother continuous data results.

Calibration Stability

During calibration, the filtering is active as described, plus an additional feature works to provide stability feedback to the user. When the user attempts to calibrate a sensor, the sudden changes in environment are perceived as impulses or plunge events and the filtering reacts accordingly. The results immediately show the value of the solution, and after a few moments, the filter incrementally engages fully and supplies the smoothest data. However, as the sensor and the calibration solution work towards equilibrium, the measurement may slowly drift. The sensor will monitor the results from the filter and determine if the measurement is stable. It watches the results and calculates a slope from each and every result to the next. Once the slope settles and is consistently flat for approximately 30 seconds, the sensor is considered stable. KorEXO is then notified and the user will see a message that the calibration reading is stable.

Sensor Response Times

Response times for EXO sensors are based on laboratory testing. This testing, though stringent, cannot mimic the actual response times in the field due to the wide variety of use cases. To characterize an EXO sensor's response time, a step change in the sensor's primary output parameter is applied, and the time to reach 63% of the final stimulus value is recorded. Repeated characterization of multiple sensors provides the T63 specification.

Sensor Accuracy Specifications

To maintain accuracy specifications for EXO sensors, we recommend that users calibrate sensors in the lab in standards with temperatures as close to the ambient temperature of the field water as possible.

4.2

Calibration Basic Overview

EXO sensors (except temperature) require periodic calibration to assure high performance. Calibration procedures follow the same basic steps with slight variations for particular parameters. Calibration procedures described in this section will mainly focus on using KorEXO Software. Users should refer to the [EXO Handheld Mini-Manual](#) for calibration procedures utilizing the handheld.

NOTE: All EXO sensors should be user-calibrated before initial use.

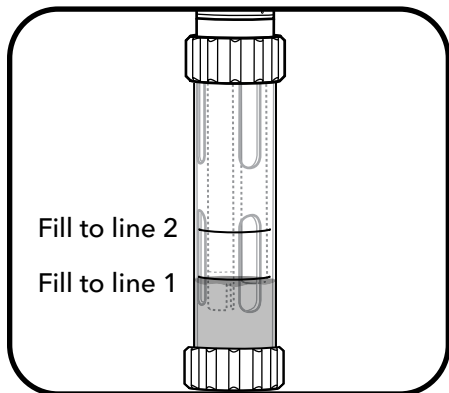

Calibration set-up

For accurate results, thoroughly rinse the EXO calibration cup with water, and then rinse with a small amount of the calibration standard for the sensor you are going to calibrate. Two to three rinses are recommended. Discard the rinse standard, then refill the calibration cup with fresh calibration standard. Fill the cup to approximately the first line with a full sensor payload or the second line with small sensor payload. Recommended volumes will vary, just make certain that the sensor is submerged. Be careful to avoid cross-contamination with other standards.

Begin with clean, dry probes installed on the EXO sonde. Install the clean calibration guard over the probe(s), and then immerse the probe(s) in the standard and tighten the calibration cup onto the EXO sonde. We recommend using one sonde guard for calibration procedures only, and another sonde guard for field deployments. This ensures a greater degree of cleanliness and accuracy for the calibration procedure.

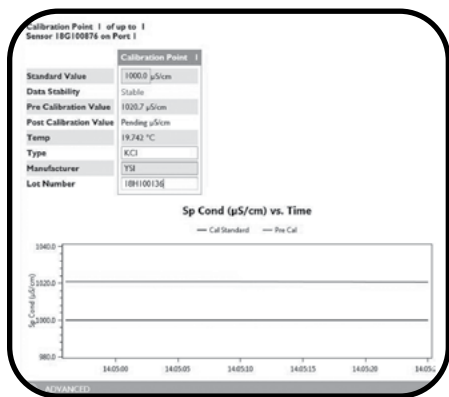

Basic calibration in KorEXO software

Go to the Calibrate menu in KorEXO Software. This menu's appearance will vary depending on the sensors installed in the sonde. Select the sensor you are going to calibrate from the list. Next select the parameter for the sensor you are going to calibrate. Some sensors have only one parameter option, while other sensors have multiple options.

Selecting the parameter will initiate the probe's calibration in the standard; initially the data reported will be unstable and then will move to stable readings. Enter the Standard Value if necessary. The Standard Value should match that of the standard you are using. You may also enter optional information for type of standard, manufacturer of standard, and lot number by accessing the Advanced menu.

Users should confirm that the value is within their acceptable margin of error. Once readings are stable, click Apply to accept this calibration point. Repeat the process for each calibration point. **Click Complete when all points have been calibrated.**

A calibration summary appears with a QC Score. View, export, and/or print the calibration worksheet. If a calibration error appears, repeat the calibration procedure.

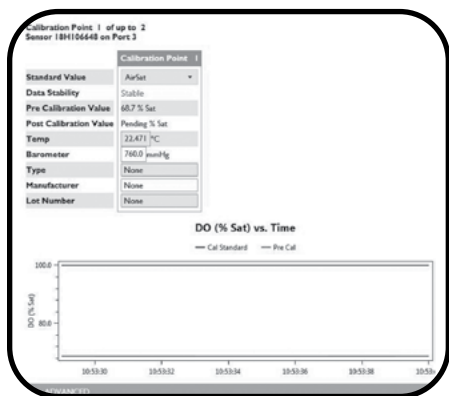

Factory Reset Calibration

A Factory Reset Calibration can be performed to return the sensor gain and offset to factory specifications. Performing a Factory Reset Calibration will allow the user to start a calibration with default sensor metadata values. A new calibration of the sensor will then help with additional troubleshooting, if needed.

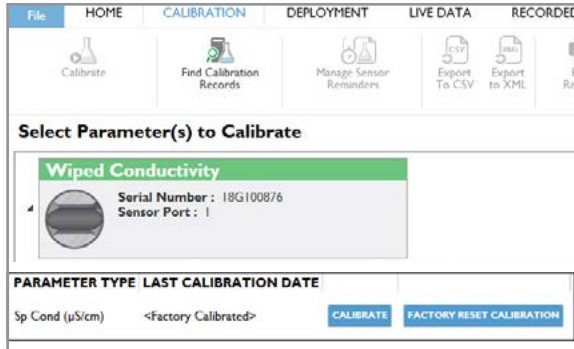

Performing a Factory Reset Calibration in KorEXO:

Step 1

Click on the Calibration tab or button.

Step 2

Click the turn-out arrow next to the parameter desired.

Step 3

Click the Factory Reset Calibration button.

Step 4

Type any desired notes into the pop-up window and then click the Yes button to confirm the action.

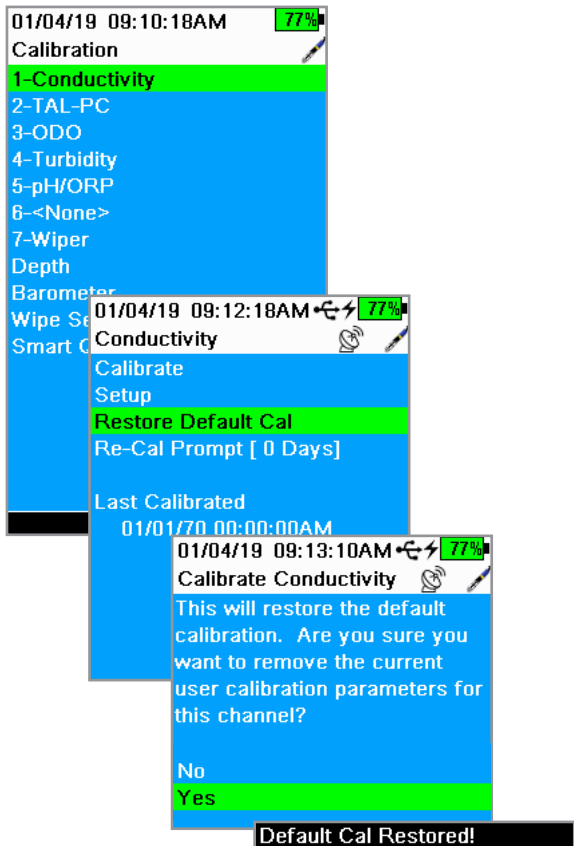
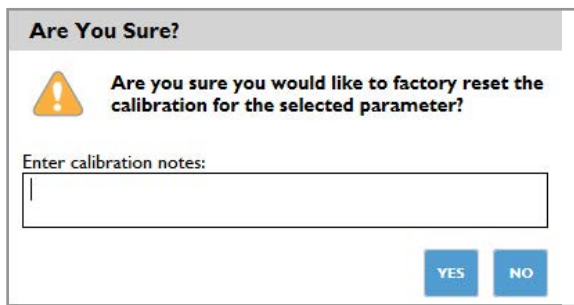

Performing a Factory Reset Calibration in the Handheld:

Step 1

Click the Calibration button.

Step 2

Select the desired parameter.

Step 3

Select Restore Default Cal.

Step 4

Select Yes. A message will be shown on the bottom of the screen to confirm that the action was successful.

4.3

Calibration Calibration Report

The Calibration Report is a record of the calibration for an EXO sensor. The report contains quality assurance information including date and time of calibration, date of previous calibration, sensor firmware version, type of calibration performed, standard used, and QC Score.

Calibration Reports are saved in the KorEXO Software database on the computer or the EXO Handheld that was used during calibration (not on the sonde or the sensors). All reports can be accessed and viewed through the Calibration Records menu in KorEXO Software.

Sample Reports:

1-point calibration of specific conductance on EXO conductivity/temperature probe

Calibration Record:	
Sensor Type: Wiped Conductivity And Temperature	
Last Calibration Time: <Unknown>	
Calibration Start Time: 1/14/2019 2:04:21 PM	
Calibration End Time: 1/14/2019 2:07:40 PM	
General	
Parameter	Sp Cond (µS/cm)
Instrument Serial Number	18H109272
Instrument Firmware Version	1.0.68
Instrument Type	EXO2
Instrument Name	Sonde 18H109272
Sensor Serial Number	18G100876
Sensor Firmware Version	3.0.5
Calibrated By	<Unknown>
Calibration Status	Completed
QC Score	Good
Calibration Point #1	
Pre Calibration Value	1019.2 µS/cm
Post Calibration Value	1000.0 µS/cm
Temperature	19.890 °C
Standard Value	1000.0 µS/cm
Type	KCl
Manufacturer	YSI
Lot Number	18H100136
Is Stable	True
Sensor Specific	
Cell Constant	0.46
Notes	
ADD NOTE	

1-point calibration of percent saturation on EXO optical dissolved oxygen probe

Calibration Record:	
Sensor Type: DO	
Last Calibration Time: 11/21/2018 8:09:59 AM	
Calibration Start Time: 11/30/2018 2:00:58 PM	
Calibration End Time: 11/30/2018 2:07:36 PM	
Instrument Serial Number	18H109272
Instrument Firmware Version	1.0.68
Instrument Type	EXO2
Instrument Name	Sonde 18H109272
Sensor Serial Number	18H106648
Sensor Firmware Version	3.0.0
Calibrated By	<Unknown>
Calibration Status	Completed
QC Score	Good
Calibration Point #1	
Pre Calibration Value	109.6 % Sat
Post Calibration Value	100.0 % Sat
Temperature	18.425 °C
Standard Value	100.0 % Sat
Type	
Manufacturer	
Lot Number	
Is Stable	True
Barometer	760.0 mmHg
Sensor Specific	
DO Cap Serial Number	18G101787
DO Cap Replacement Date	8/13/2018
DO Gain	1.04
DO (mg/L)	9.26 mg/L
Notes	
ADD NOTE	

Additional Post-Calibration Info

ODO Gain: The ODO gain is a diagnostic value recorded on the Calibration Report and used for advanced diagnostic purposes. The nominal value is 1, and accurate calibrations of the DO sensor will only slightly deviate from this number.

Cell Constant: The cell constant is the current value of the conductivity and is a function of the factory original cell constant and the most recent user calibration. The cell constant will drift over time based on the sensor’s electrodes, and the cell constant can be used to track drift.



Slope: The slope for the pH sensor is the mV per decade (pH unit) where 59 is the typical value. Slope allows the user to track drift away from 59 to determine the life/aging of the sensor module.

Change mV: The change millivolts is the mV change between either 4 and 7 or 7 and 10 calibration values for the pH sensor. It is the mV deviation away from the middle calibration point number.

4.4

SmartQC Overview

SmartQC is a mechanism to normalize different sensors and to assess the current state of individual sensor performance relative to factory-defined performance parameters. Every EXO sensor has an embedded microprocessor which, along with calibration metadata, enables EXO to warn users of calibration errors or when a sensor is unable to be calibrated due to age, fouling, or damage, for example. For any sensor a QC Score is presented as red, yellow, or green:

-  A **green** SmartQC Score means the sensor is calibrated properly and all parameters used to assess its performance state are within factory-defined limits.
-  A **yellow** SmartQC Score means that the sensor will still perform within factory-defined limits, but that during calibration enough of an adjustment was required to suggest that the sensor is drifting from those limits or may soon require some adjustments, such as a new DO cap. A yellow QC Score might also result from variations in calibration standards and operators. One's comfort with a yellow score is case-dependent: for long-term deployments a yellow score is not optimal. For deployments of a couple of weeks or for spot-sampling, a yellow score may be perfectly acceptable, depending upon the sensor in question. This is addressed for individual sensors throughout the EXO Manual.
-  A **red** SmartQC Score means that the sensor is not performing within factory-specified limits. Also, in some cases a red QC Score might mean that a component of the sensor is due to be replaced (such as a DO cap), or the user has defined some other limit, such as the term expired since the most recent calibration. These examples are captured under the term *SoftQC* because they are set by the user in Kor software, and such settings will override a green SmartQC Score when using the software.

The way in which EXO assesses the calibration metadata is dependent upon the sensor type, and examples of information used include signal to noise ratio, signal gain, raw millivolts, and cell constants. "Gain" is one of the most common principles applied in the SmartQC system, and one might think of gain as m in the linear relationship $y = mx + b$ where x is the real-time parameter result computed from a particular factory setting and y is the same parameter but modified and computed from a setting as defined by the user's calibration.

For example suppose that during a calibration the %ODO saturation is calculated from the factory settings to be 92%. This would be x . This same setting may be calculated to be 97% during the user's calibration, and this would be y . The gain, or m , would be calculated to be 1.054, and in this specific example that would be reported in the calibration worksheet as the *ODO Gain*.

In an ideal world where gains are calculated, m would be 1 and b would be zero, meaning that there has been no change at all in the sensor's performance since it left the factory. For most sensors this simple relationship can be applied, and gain and offsets are the primary drivers of the QC Score (the ranges for them are proprietary, however). Other sensors have more complex sets of coefficients that are used, and factory-to-user calibration outputs are defined by more complex polynomial relationships.

Though proprietary limits and algorithms are used in calculation of the QC Scores, much of the metadata that are used (such as millivolts, slopes, or gain factors) are visible to the user in the calibration worksheets. Sometimes these metadata are of more value to the user than the actual QC Score, and users can assess whether and how they should use these metadata to build their own SOPs and acceptance criteria. This is readily achieved since each calibration worksheet shows not only the QC Score for that calibration event but also the metadata and an audit trail for sensor calibration and performance throughout a sensor's lifetime.

In this manual each individual sensor is described, and the descriptions of calibration for each sensor include recommendations regarding the interpretation and steps to take based upon green, yellow, or red QC Scores.

4.5

Conductivity / Temperature

Sensor Overview

The EXO combination conductivity and temperature sensor should be installed in nearly all sonde applications. Not only will this sensor provide the most accurate and fastest response temperature data, but it will also provide the best data for the use in temperature compensation for the other EXO probes. The conductivity data is used to calculate salinity, non-linear function (nLF) conductivity, specific conductance, and total dissolved solids, and compensate for changes in density of water (as a function of temperature and salinity) in depth calculations if a depth sensor is installed.

(continued)

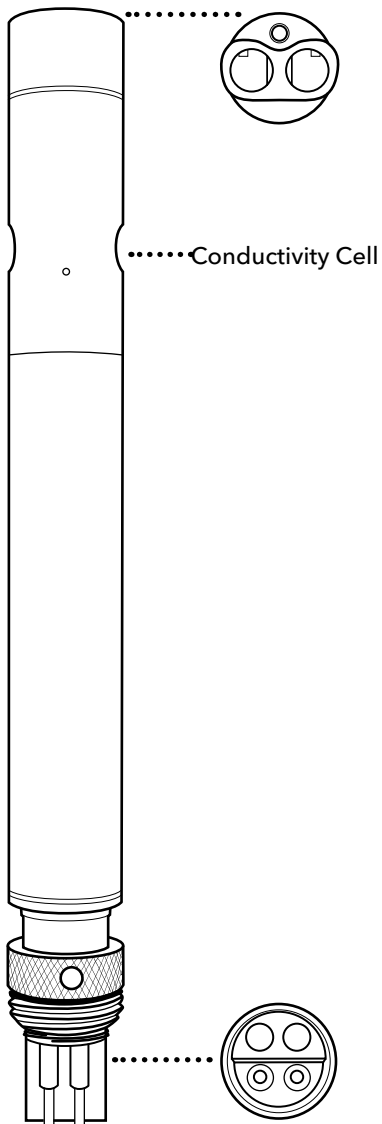

..... Conductivity Cell

Specifications

Conductivity

Default Units	microSiemens/centimeter
Temperature	
Operating	-5 to +50°C
Storage	-20 to +80°C
Range	0 to 200 mS/cm
Accuracy	0-100 mS/cm: ±0.5% of reading or 0.001 mS/cm, whichever is greater; 100-200 mS/cm: ±1% of reading
Response	T63<2 sec
Resolution	0.0001 to 0.01 mS/cm range-dependent
Sensor Type	4-electrode nickel cell

Temperature

Default Units	°Celsius
Temperature	
Operating	-5 to +50°C
Storage	-20 to +80°C
Accuracy	-5 to 35°C: ±0.01°C 35 to 50°C: ±0.05°C
Response	T63<1 sec
Resolution	0.001°C
Sensor Type	Thermistor

599870-01

Temperature Thermistor

The temperature sensor uses a highly stable and aged thermistor with extremely low-drift characteristics. The thermistor's resistance changes with temperature. The measured resistance is then converted to temperature using an algorithm. The temperature sensor receives a multi-point NIST traceable wet calibration and the accuracy specification of 0.01°C is valid for expected life of the probe. No calibration or maintenance of the temperature sensor is required, but accuracy checks can be conducted against a NIST-traceable temperature probe supplied by the user.

Conductivity Electrodes

The conductivity sensor uses four internal, pure-nickel electrodes to measure solution conductance. Two of the electrodes are current driven, and two are used to measure the voltage drop. The measured voltage drop is then converted into a conductance value in milliSiemens (millimhos). To convert this value to a conductivity value in milliSiemens per cm (mS/cm), the conductance is multiplied by the cell constant that has units of reciprocal cm (cm⁻¹). The cell constant for the conductivity cell is approximately 5.1/cm ±10%. For most applications, the cell constant is automatically determined (or confirmed) with each deployment of the system when the calibration procedure is followed.

Temperature Compensation

EXO sensors have internal thermistors for quality assurance purposes. Turbidity uses the internal thermistor for temperature compensation, while all other EXO sensors reference the C/T probe for temperature compensation. To display and log temperature, a C/T probe must be installed in an EXO sonde. Thermistor readings are logged in the sonde's raw data-viewable in KorEXO software—but are not included in data exported to Excel.

Conductivity = This is a measurement of water conductance from the drive and sense electrodes on the conductivity electrode. The output is in mS/cm or µS/cm. Note that the conductivity of solutions of ionic species is highly dependent on temperature, and the conductivity output is NOT compensated for temperature.

Specific Conductivity = When Specific Conductance is selected, the sonde uses the temperature and raw conductivity values associated with each determination to generate a specific conductance value compensated to 25°C by default. Both the Temperature Coefficient and reference temperature can be adjusted in the advanced sensor menu under calibration.

nLF Conductivity = The non-linear function (nLF) is defined by the ISO 7888 standard and is applicable for the temperature compensation of electrolytic conductivity of natural waters. This convention is typically used in German markets.

Salinity = Salinity is determined automatically from the sonde conductivity and temperature readings according to algorithms found in Standard Methods for the Examination of Water and Wastewater (ed. 1989). The use of the Practical Salinity Scale results in values that are unitless, since the measurements are carried out in reference to the conductivity of standard seawater at 15 °C.

4.6

Conductivity / Temperature Calibration

Clean the conductivity cell with the supplied soft brush before calibrating (see [Section 5.7](#)). Also, review the basic calibration description in [Section 4.2](#).

This procedure calibrates conductivity, non-linear function (nLF) conductivity, specific conductance, salinity, and total dissolved solids.

A variety of standards are available based on the salinity of your environment. Select the appropriate calibration standard for your deployment environment; we recommend using standards greater than 1 mS/cm (1000 μ S/cm) for greatest stability.

Pour conductivity standard into a clean and dry or pre-rinsed EXO calibration cup. YSI recommends filling the calibration cup up to the second marked line to ensure the standard is above the vent holes on the conductivity sensor. Immerse the probe end of the sonde into the solution, gently rotate and/or move the sonde up and down to remove any bubbles from the conductivity cell.

Allow at least one minute for temperature equilibration before proceeding.

In the Calibrate menu, select the Conductivity sensor and then select the parameter you wish to calibrate. These parameters may include conductivity, nLF conductivity, specific conductance, or salinity. Calibrating any one option automatically calibrates the other parameters. After selecting the option of choice (specific conductance is normally recommended), enter the value of the standard used during calibration. Be certain that the units are correct (microsiemens, not millisiemens).

Observe the Pre Calibration Value readings and the Data Stability, and when they are Stable, click Apply to accept this calibration point.

NOTE: If the data do not stabilize after 40 seconds, gently rotate the sonde or remove/reinstall the cal cup to make sure there are no air bubbles in the conductivity cell.

Click Complete. View the Calibration Summary screen and QC Score. Click Exit to return to the sensor calibration menu.

Rinse the sonde and sensor(s) in tap or purified water and dry.

SmartQC for Conductivity/Temperature Sensors

The SmartQC Score for conductance is based on a gain factor, which is then computed into a cell constant that appears on the Calibration Report. The gain may drift over time due to aging electrodes and wear, and this will ultimately affect the cell constant.



An ideal cell constant is dependent upon the type of conductivity sensor; there are two types of conductivity sensors (wiped and non-wiped) on the EXO platform:

- For non-wiped conductivity (599870), the ideal cell constant = $5.1/\text{cm} \pm 10\%$

The CT sensor can be evaluated in air when it is new, and as the sensor ages this may be a useful tool for assessing its drift from factory performance. To perform an air check:

1. Clean the sensor thoroughly.
2. Perform a Factory Reset Calibration.
3. Rinse the sensor with DI water and dry it thoroughly.
4. Observe sensor readings in air. They should be very close to zero. While this is a subjective assessment, if the user has an idea of what air readings were when the sensor was new, monitoring this on occasion can provide clues as to whether the sensor is aging out of use.

Guidance on interpretation of the SmartQC Score for this sensor is as follows:

 **Green:** Gain is within acceptable limits. Calibration was performed successfully and resulted in a gain within factory specified limits.

 **Yellow:** The gain has drifted a minor amount from factory specified limits. The sensor is still reporting correctly but adjustments may need to be made. If a user calibration results in a yellow QC Score, perform the following actions:

1. Thoroughly clean the sensor and ensure that all debris is removed from the surfaces of the sensor. Refer to [Section 5.7](#) for additional information on how to properly clean the sensor in order to avoid damaging the sensor.
2. Next, perform a Factory Reset Calibration to reset the gain and cell constant to their factory default values. This is described in [Section 4.2](#).
3. Check specific conductivity readings in air, and verify they are less than $1 \mu\text{s}/\text{cm}$. If reading higher in air, thoroughly clean the sensor, and allow it to dry completely before checking in air again.
4. Complete another calibration on the sensor using fresh standard solution.

If the QC Score remains yellow, the sensor is still able to be used, but the user should monitor this sensor during calibrations, including looking at the cell constant on the Calibration Reports.

 **Red:** The gain has drifted significantly from the factory specified limits, and the sensor may not report correct values. If a user calibration results in a red QC Score, perform the following actions:

1. Verify that the standard value used during calibration was entered correctly. If the value was not entered correctly, the resulting QC Score would show a red value due to the gain changing significantly.
2. Thoroughly clean the sensor and ensure that all debris is removed from the surfaces of the sensor. Refer to [Section 5.7](#) for additional information on how to properly clean the sensor in order to avoid damaging the sensor.
3. Perform a Factory Reset Calibration.
4. Complete a calibration using fresh standard.

If the QC Score returns to red after these steps, please contact YSI Technical Support for further assistance.

4.7

Wiped Conductivity / Temperature Sensor Overview

Biofilms, barnacles, and algal growth are common culprits of poor data quality, clogging up conductivity cells and coating sensor optics. While EXO2's Central Wiper can mechanically remove biofouling from other sensors to maintain data integrity over long deployment periods, in particularly high fouling environments the EXO Wiped C/T sensor provides superior conductivity data by avoiding stagnant readings and reducing the impact of micro-environments.

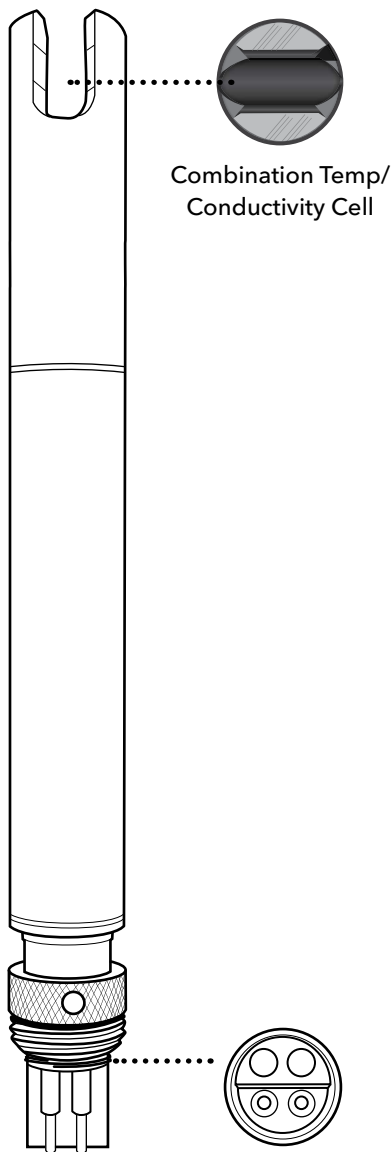

599827

EXO Wiped C/T Considerations

Sensor performance and specifications are well suited for continuous monitoring applications, where the EXO sonde is installed at a fixed location. For sampling and vertical profiling applications the legacy (599870) Conductivity Temperature probe which has a much faster temperature response should be used.

The Wiped C/T will have a different cell constant than the legacy Conductivity probes. A nominal cell constant of 0.469 +/-0.05 is typical on wiped conductivity.

The EXO central wiper (599090) must have the wiper shaft seal serviced in the past year to use with your new wiped C/T probe. The wiper will work harder grooming the new sensor, therefore if your wiper hasn't had the shaft seal properly maintained there is a chance it could stall mid deployment.

Specifications

Conductivity

Range	0-100,000 $\mu\text{S}/\text{cm}$
Accuracy	$\pm 1\%$ of reading or 2 $\mu\text{S}/\text{cm}$ w.i.g.

Temperature

Range	-5 to 50°C
Accuracy	$\pm 0.2^\circ\text{C}$
Response Time	T95 < 30sec

Specific Conductance

Range	0-100,000 $\mu\text{S}/\text{cm}$
Accuracy	$\pm 1\%$ of reading or 2 $\mu\text{S}/\text{cm}$ w.i.g.

w.i.g. = whichever is greater



Watch Online
 EXO2 Wiped (C/T) Video
 Quick Start Guide:
<https://goo.gl/w67OQU>

4.8

Wiped Conductivity / Temperature Calibration and Deployment

Calibration

A wet calibration of your new conductivity sensor should be completed before initial use. It is recommended that you complete a single point calibration in a standard similar to the conductivity readings that you expect to measure. It is recommended not to use standards below 1,000 $\mu\text{S}/\text{cm}$ for fresh water applications as they can become easily contaminated. The temperature sensor cannot be user calibrated. Best practice is to periodically test the performance of the temperature sensor against a NIST traceable thermometer at several reference points.

NOTE: All EXO sensors should be user calibrated before initial use.

Deployment Setup

The Wiped C/T sensor is optimized for continuous monitoring where a variety of environmental fouling conditions would affect the performance of the sensor without wiping. Numerous solutions can be employed to mitigate the effects of biofouling. These can include the use of copper tape, anti-fouling guards, anti-fouling paints, as well as local techniques developed for site specific challenges. However, none of these options can be directly applied to the conductivity cell of the Wiped C/T sensor. Using the central wiper to groom the conductivity cell before readings prevents biofouling-induced drift of the conductivity cell.

The sensor includes a new central wiper brush (599673). A brush's wear and replacement intervals vary greatly based on specific application challenges, but 2-12 months use has been observed. Below are three examples of brush wear that will occur with use. It is recommended the wiper brush be replaced before it reaches level 3 for optimal cleaning. We recommend using a new wiper brush with the initial deployment.



Level 1- New brush, minimal "splay"



Level 2- Moderate splaying, have spare ready



Level 3- Excessive splay, replace to prevent stalling of wiper

NOTICE: It is not recommended using Wiped C/T in conjunction with EXO Ammonium, Nitrate, or Chloride electrodes as they are protected with a guard which accelerates the brush splay.

Sensor Installation

A new sensor includes a kit (599831) containing probe alignment o-rings and disposable zip ties. These items are to be used to optimally align the wiped conductivity probe cell with the brush. Refer to the instruction sheet included in the kit for directions and recommendations for applying the spacers. EXO sensors can be installed in any port, however for optimal cleaning avoid installing the Wiped C/T sensor as the first or last sensor in a group. If two conductivity sensors are installed in a single sonde, the temperature from the sensor with the lower port will be used for temperature compensation of other parameters.

Having the sensor installed towards the middle of an array is optimal. Below are some examples:

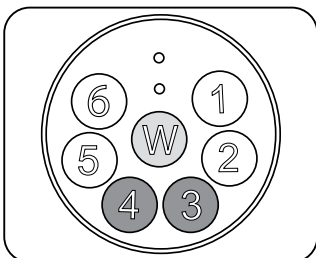

EXO2 Optimal Wiped C/T positions: 3 or 4

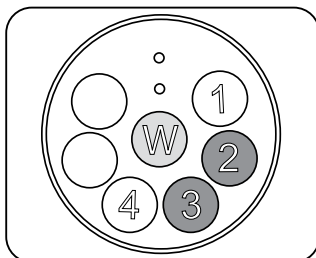

EXO2 Optimal Wiped C/T positions: 2 or 3

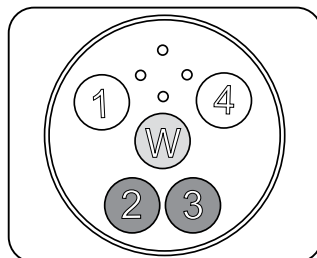

EXO3 Optimal Wiped C/T positions: 2 or 3

NOTICE: When installing a Wiped Conductivity/Temperature sensor in an EXO3 sonde, use ports 2 and 3.

SmartQC for Wiped Conductivity/Temperature Sensors

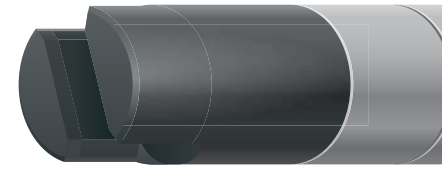

The SmartQC Score for conductance is based on a gain factor, which is then computed into a cell constant that appears on the Calibration Report. The gain may drift over time due to aging electrodes and wear, and this will ultimately affect the cell constant.

An ideal cell constant is dependent upon the type of conductivity sensor; there are two types of conductivity sensors (wiped and non-wiped) on the EXO platform:

- For wiped conductivity (599827), the ideal cell constant = $0.469/\text{cm} \pm 0.05$

Guidance on interpretation of the SmartQC Score for this sensor is as follows:



Green: Gain is within acceptable limits. Calibration was performed successfully and resulted in a gain within factory specified limits.



Yellow: The gain has drifted a minor amount from factory specified limits. The sensor is still reporting correctly but adjustments may need to be made. If a user calibration results in a yellow QC Score, perform the following actions:

1. Thoroughly clean the sensor and ensure that all debris is removed from the surfaces of the sensor. Refer to [Section 5.7](#) for additional information on how to properly clean the sensor in order to avoid damaging the sensor.
2. Next, perform a Factory Reset Calibration to reset the gain and cell constant to their factory default values. This is described in [Section 4.2](#).
3. Check specific conductivity readings in air, and verify they are less than $1 \mu\text{s}/\text{cm}$. If reading higher in air, thoroughly clean the sensor, and allow it to dry completely before checking in air again.
4. Complete another calibration on the sensor using fresh standard solution.

If the QC Score remains yellow, the sensor is still able to be used, but the user should monitor this sensor during calibrations, including looking at the cell constant on the Calibration Reports.



Red: The gain has drifted significantly from the factory specified limits, and the sensor may not report correct values. If a user calibration results in a red QC Score, perform the following actions:

1. Verify that the standard value used during calibration was entered correctly. If the value was not entered correctly, the resulting QC Score would show a red value due to the gain changing significantly.
2. Thoroughly clean the sensor and ensure that all debris is removed from the surfaces of the sensor. Refer to [Section 5.7](#) for additional information on how to properly clean the sensor in order to avoid damaging the sensor.
3. Perform a Factory Reset Calibration.
4. Complete a calibration using fresh standard.

If the QC Score returns to red after these steps, please contact YSI Technical Support for further assistance.

4.9 Depth and Level Sensor Overview

EXO measures depth of water with a non-vented strain gauge. (See [Section 6](#) if your sonde is equipped with vented level.) A differential strain gauge transducer measures pressure with one side of the transducer exposed to the water and the other side exposed to a vacuum. We calculate depth from the pressure exerted by the water column minus atmospheric pressure. Factors influencing depth measurement include barometric pressure, water density, and temperature. Calibration in the atmosphere “zeros” the sensor with respect to the local barometric pressure. A change in barometric pressure will result in a zero shift unless the transducer is recalibrated to the new pressure.

EXO sondes have intake openings to allow water to act on the strain gauge. The EXO1 intake is located in the yellow section between the battery compartment and label of the sonde. The EXO2 intake openings are two small holes on the face of the sonde bulkhead.

Location of Depth Sensor

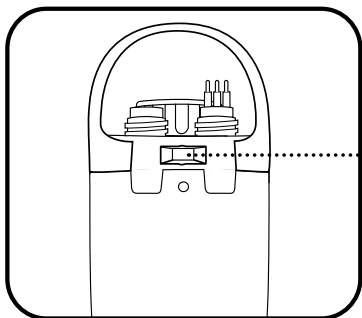

Depth Sensor Location relative to other water quality sensors (see EXO sonde label)

 Depth Sensor Location
27.2 cm (EXO1), 13.9 cm (EXO2)
to WQ Sensors

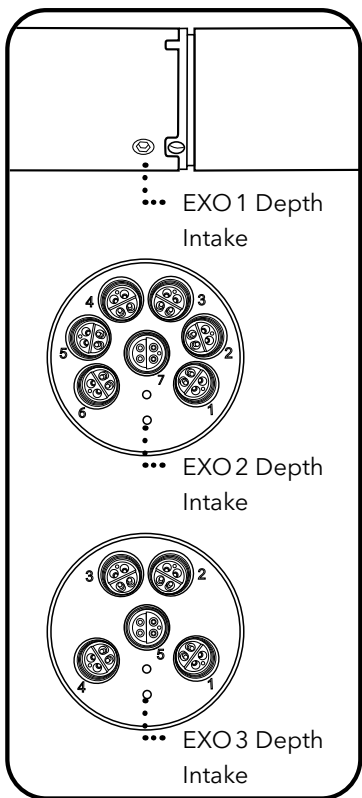

Depth sensors on the EXO2 sondes are not on center. When deploying the sonde *vertically*, take care to ensure the sonde is redeployed in same position. Often a marker pin inside a PVC pipe is used. In *horizontal* deployments, take care to ensure the redeployments are always in the same orientation. This is especially important for the EXO2 sonde because the depth sensor is off-axis.

... To assist with consistent horizontal orientation, the EXO2 sonde has an indentation at the top of the sonde for a marker or positioning pin.

The sonde should be installed with at least 1 cm of water above the intake ports. If a conductivity sensor is installed, the depth will be compensated automatically for changes in the density of water as temperature and salinity change.

Depth Configuration

EXO sondes must be ordered with a specific depth sensor option:

- 59950x-00 = no depth
- 59950x-01 = 0-10 m depth
- 59950x-02 = 0-100 m depth
- 59950x-03 = 0-250 m depth
- 59950x-04 = 0-10 m vented level

The depth configuration must be chosen at time of ordering. Once a sonde is shipped with a depth configuration it cannot be changed by the user.

Specifications

Units	PSI, Depth (m, ft, bar)
Temperature	
<i>Operating</i>	-5 to +50°C
<i>Storage</i>	-20 to +80°C
Range	<i>Shallow:</i> 0 to 33 ft (10 m) <i>Medium:</i> 0 to 328 ft (100 m) <i>Deep:</i> 0 to 820 ft (250 m) <i>Vented:</i> 0 to 33 ft (10 m)
Accuracy	<i>Shallow:</i> ±0.04% FS (±0.013 ft or ±0.004 m) <i>Medium:</i> ±0.04% FS (±0.13 ft or ±0.04 m) <i>Deep:</i> ±0.04% FS (±0.33 ft or ±0.10 m) <i>Vented:</i> ±0.03% FS (±0.010 ft or ±0.003 m)
Response	T63 < 2 sec
Resolution	0.001 ft (0.001 m)
Sensor Type	Stainless steel strain gauge

4.10 Depth and Level Calibration

NOTE: This calibration option is available only if your sonde is equipped with an integral depth sensor or a vented level sensor.

For the calibration, make certain that the depth sensor or vented level sensor is in air and not immersed in any solution. Also, review the basic calibration description in [Section 4.2](#).

In the Calibrate menu, select Depth and then select Calibrate.

0 is the only acceptable calibration value. An offset may be entered under the Depth sensor settings. See "Advanced" below.

Observe the Pre Calibration Value readings and the Data Stability, and when they are Stable, click Apply to accept this calibration point. This process zeros the sensor with regard to current barometric pressure.

Click Exit to return to the sensor calibration menu.

For best performance of depth measurements, users should ensure that the orientation of the sonde remains constant while taking readings. This is especially important for vented level measurements. Keep the sonde still and in one position while calibrating.

Advanced

Configure Depth Settings by selecting the Depth Sensor under the Instrument and Sensors menu.

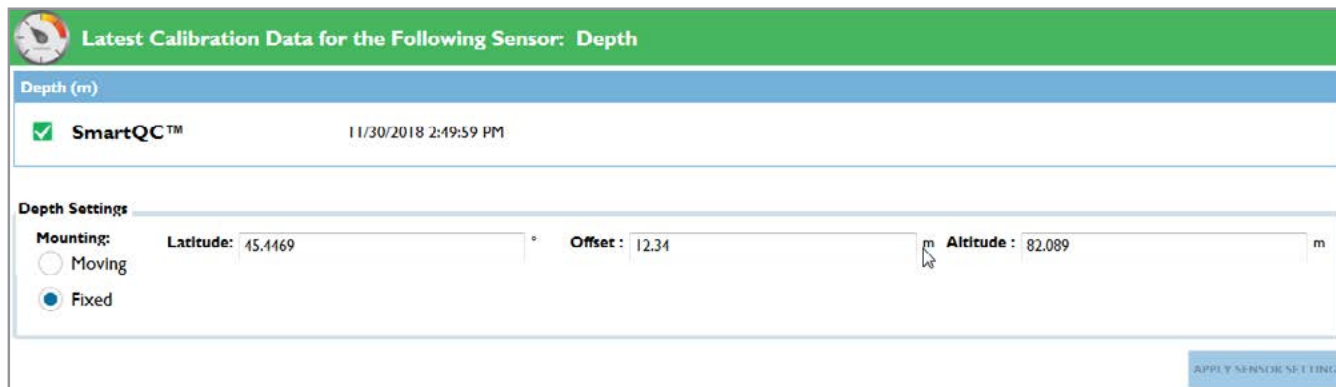

The screenshot displays a software interface for depth sensor calibration. At the top, a green header reads "Latest Calibration Data for the Following Sensor: Depth". Below this, a blue bar indicates "Depth (m)". The main area shows a green checkmark, the sensor name "SmartQC™", and the timestamp "11/30/2018 2:49:59 PM". Under "Depth Settings", there are two radio buttons for "Mounting": "Moving" (unselected) and "Fixed" (selected). To the right, there are input fields for "Latitude: 45.4469", "Offset: 12.34 m", and "Altitude: 82.089 m". A blue "APPLY SENSOR SETTING" button is located at the bottom right.

Mounting: Use the Advanced menu to select if a sonde will be mounted in a moving/profiling deployment instead of a fixed location.

Depth Offset: Enter a value in meters (m) to offset the depth at the point of measurement.

Altitude/Latitude: Enter the coordinates for the local altitude (in feet, relative to sea level) and latitude (in degrees) where the sonde is sampling. Latitude values are used in the calculation of depth or level to account for global variations in the gravitational field.

SmartQC for Depth

The SmartQC Score for depth and vented level is based upon an expected offset that would be computed by the sensor at the time of calibration.



Guidance on interpretation of the SmartQC Score for this sensor is as follows:

-  **Green:** The offset computed during the calibration is within factory specified limits.

-  **Yellow:** The offset computed during the calibration is near the threshold of factory specified limits. If a user calibration results in a yellow QC Score, perform the following actions:
 1. If the sensor is being deployed at high altitudes, the computed offset during calibration may be outside of the factory specified limits. The data collected by the depth sensor at higher elevations is not incorrect; simply the offset is outside of normal lower-elevation ranges. At higher elevations, all sensors may experience the yellow QC Score and a green QC Score may never be attainable.
 2. Ensure that the sensor is free of debris. If there is debris clogging the inlet, use water to clear the inlet. Use care to avoid damaging the thin pressure membrane. Refer to [Section 5.5](#) for additional information on how to properly clean the instrument in order to avoid damaging the sensor.
 3. Make sure that the sensor was completely dry before performing the calibration. If needed, use a can of compressed air to dry off the sensor to perform a better calibration. Do NOT stick any tools or utensils inside the pressure sensor vent hole. The sensor membrane is extremely thin and easily punctured.
 4. Perform a Factory Reset Calibration to restore the offset to factory calibrated values and then perform another calibration.
 5. Vented Only: Verify that the tube exposed to atmospheric conditions is properly connected to a desiccant canister or connected to a dummy plug to prevent moisture from entering the vent tube. If moisture accumulates in the vent tube, calibrations will not be accurate. Information on how to connect a desiccant container to a vented level sonde can be found in [Section 6](#).

If the QC Score is still yellow after performing another calibration, the sensor is still able to be used. The user should continue to monitor the sensor for additional drift away from the factory defaults.

-  **Red:** The offset computed during the calibration is significantly outside of factory specified limits. If a user calibration results in a red QC Score, perform the following actions:
 1. Ensure that the sensor inlet is free of debris. If there is debris clogging the inlet, use water to clear the inlet. Use care to avoid damaging the thin pressure membrane. Refer to [Section 5.5](#) for additional information on how to properly clean the instrument in order to avoid damaging the sensor.
 2. Perform a Factory Reset Calibration to restore the offset to factory calibrated values and then perform another calibration.
 3. Vented Only: Determine if there is a likelihood that moisture has entered the vent tube. If the desiccant canister is full of water, the vent tube may have significant moisture inside.

If the QC Score returns to red after the above procedures were performed, please contact YSI Technical Support for further assistance.

4.11 Dissolved Oxygen

Sensor Overview

The principle of operation of the EXO optical dissolved oxygen sensor is based on the well-documented concept that dissolved oxygen quenches both the intensity and the lifetime of the luminescence associated with a carefully chosen chemical dye. The EXO DO sensor operates by shining a blue light of the proper wavelength on this luminescent dye which is immobilized in a matrix and formed into a disk. The blue light causes the immobilized dye to luminesce and the lifetime of this dye luminescence is measured via a photodiode in the probe. To increase the accuracy and stability of the technique, the dye is also irradiated with red light during part of the measurement cycle to act as a reference in the determination of the luminescence lifetime.

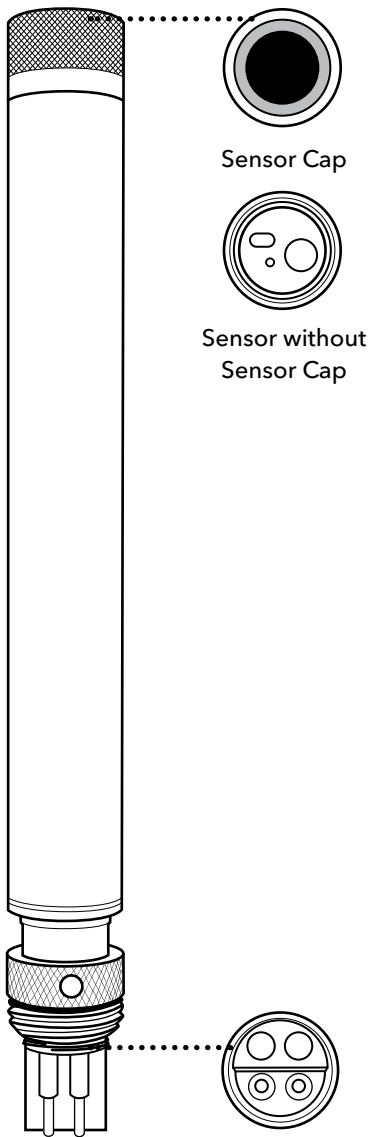

599100-01;
599110 sensor cap

When there is no oxygen present, the lifetime of the signal is maximal; as oxygen is introduced to the membrane surface of the sensor, the lifetime becomes shorter. Thus, the lifetime of the luminescence is inversely proportional to the amount of oxygen present and the relationship between the oxygen pressure outside the sensor and the lifetime can be quantified by the Stern-Volmer equation: $((T_{zero}/T) - 1)$ versus O_2 pressure

For most lifetime-based optical DO sensors, this Stern-Volmer relationship is not strictly linear (particularly at higher oxygen pressures) and the data must be processed using analysis by polynomial non-linear regression. Fortunately, the non-linearity does not change significantly with time so that, as long as each sensor is characterized with regard to its response to changing oxygen pressure, the curvature in the relationship does not affect the ability of the sensor to accurately measure oxygen for an extended period of time.

(continued)

Specifications

Units	% Saturation, mg/L
Temperature	
<i>Operating</i>	-5 to +50°C
<i>Storage</i>	-20 to +80°C
Range	0 to 500% air sat. 0 to 50 mg/L
Accuracy	0-200%: ±1% reading or 1% air sat., whichever is greater; 200-500%: ±5% reading 0-20 mg/L: ±1% of reading or 0.1 mg/L; 20-50 mg/L: ±5% reading
Response	T63 < 5 sec
Resolution	0.1% air sat. 0.01 mg/L
Sensor Type	Optical, luminescence lifetime

Variables that Affect DO Measurements

Variables that could affect dissolved oxygen measurements include temperature, salinity, and barometric pressure. Temperature and salinity are compensated for during instrument calibration and field use with the use of additional sensors and/or instrument software settings.

Barometric pressure relates to the pressure of oxygen in the calibration environment, and barometric pressure changes due to a change in altitude or local weather. Generally the effect of barometric pressure is overcome by proper sensor calibration to a standard pressure.

If DO % Local is being measured, it may be necessary to recalibrate the instrument after significant changes in barometric pressure or altitude in order to keep the DO% Local value at 100% in a fully saturated environment.

If DO % EU is being measured, the reading is corrected in real time by live barometric pressure readings in order to maintain a value at 100% in a fully saturated environment regardless of local pressure changes.

Note that this process is only achievable when connected to an EXO Handheld or EXO GO, as live barometric pressure is required for real time compensation.

ODO % Sat = Raw DO reading corrected with temperature and local barometric pressure at the time of calibration:
 $(\text{local mmHg} / 760 \text{ mmHg}) \times 100 = \% \text{Sat}$

ODO % Local = Raw DO reading corrected with temperature and % Sat output fixed to 100% regardless of barometric pressure entry. (The entered local barometric pressure is used by KorEXO software for mg/L calculations.)

ODO % EU = ODO % Sat reading corrected with live barometric reading (available only when the sonde is connected to the EXO Handheld or EXO GO). Fixes the % Sat output to 100%, and conforms to British and EU standards.

4.12 Dissolved Oxygen Calibration

First review the basic calibration description in [Section 4.2](#).

ODO % sat and ODO % local - 1-point

Place the sonde with sensor into either water-saturated air or air-saturated water:

- (a) Water-saturated air: Ensure there are no water droplets on the DO sensor or the thermistor. Place into a calibration cup containing about 1/8 inch of water that is vented by loosening the threads. (Do not seal the cup to the sonde.) Wait 10-15 minutes before proceeding to allow the temperature and oxygen pressure to equilibrate. Keep out of direct sunlight.
- (b) Air-saturated water: Place into a container of water which has been continuously sparged with an aquarium pump and air stone for one hour. Wait approximately 5 minutes before proceeding to allow the temperature and oxygen pressure to equilibrate.

In the Calibrate menu, select ODO, then select ODO % sat or ODO % local. Calibrating in ODO % sat automatically calibrates ODO mg/L and ODO % local and vice versa.

Enter the current barometric pressure in mm of Hg (Inches of Hg x 25.4 = mm Hg).

NOTE: *Laboratory barometer readings are usually "true" (uncorrected) values of air pressure and can be used "as is" for oxygen calibration. Weather service readings are usually not "true"; i.e., they are corrected to sea level, and therefore cannot be used until they are "uncorrected". An approximate formula for this "uncorrection" (where the BP readings MUST be in mm Hg) is:*
True BP = [Corrected BP] - [2.5 * (Local Altitude in ft above sea level/100)]

Observe the Pre Calibration Value readings and the Data Stability, and when they are Stable, click Apply to accept this calibration point.

Click Complete. View the Calibration Summary screen and QC Score. Click Exit to return to the sensor calibration menu.

mg/L - 1-point

Place the sonde with sensor in a container which contains a known concentration of dissolved oxygen in mg/L and that is within $\pm 10\%$ of air saturation as determined by one of the following methods:

- Winkler titration
- Aerating the solution and assuming that it is saturated
- Measurement with another instrument

NOTE: *Carrying out DO mg/L calibrations at values outside the range of $\pm 10\%$ of air saturation is likely to compromise the accuracy specification of the EXO sensor. For highest accuracy, calibrate in % saturation.*

In the Calibrate menu, select ODO, then select ODO mg/L. Calibrating in ODO mg/L automatically calibrates ODO % sat and vice versa.

Enter the known mg/L concentration for the standard value. Observe the Pre Calibration Value readings and the Data Stability, and when they are Stable, click Apply to accept this calibration point. Click Complete.

Rinse the sonde and sensor(s) in tap or purified water and dry.

ODO % sat, ODO % local or mg/L - 2-point (or zero point)

Normally it is not necessary to perform a 2-point calibration for the DO sensor, and the procedure is not recommended unless (a) you are certain that the sensor does not meet your accuracy requirements at low DO levels and (b) you are operating under conditions where you are certain to be able to generate a medium which is truly oxygen-free.

For ODO % sat or ODO % local, calibrate your sonde at zero oxygen and in water-saturated air or air-saturated water. For ODO mg/L, calibrate your sonde at zero oxygen and a known concentration of oxygen within $\pm 10\%$ of air-saturation. The key to performing a 2-point calibration is to make certain that your zero-oxygen medium is truly oxygen-free:

- If you use nitrogen gas for the zero-point calibration, make certain that the vessel you use has a small exit port to prevent back diffusion of air and that you have completely purged the vessel before confirming the calibration.
- If you use sodium sulfite solution for the zero-point calibration, prepare the solution at a concentration of approximately 2 g/L at least two hours prior to use and keep it sealed in a bottle which does not allow diffusion of oxygen through the sides of the container. Transfer the sodium sulfite solution rapidly from its container to the calibration cup, fill the cup as full as possible with solution to minimize head space, and seal the cup to the sonde to prevent diffusion of air into the vessel.

Place the sonde with DO and temperature sensors in the zero-oxygen medium.

In the Calibrate menu, select ODO, then select either ODO % sat, ODO % local or ODO mg/L.

Select Zero from the Standard Value drop-down window.

Observe the Pre Calibration Value readings and the Data Stability, and when they are Stable, click Apply to accept this calibration point.

- If you used sodium sulfite solution as your zero calibration medium, you must thoroughly remove all traces of the reagent from the probes and wiper prior to proceeding to the second point. We recommend that the second calibration point be in air-saturated water if you use sodium sulfite solution.

Next place the sensors in the medium containing a known oxygen pressure or concentration and wait at least 10 minutes for temperature equilibration. Click Add Another Cal Point. Then enter either the barometer reading in mm Hg (for ODO %) or the actual concentration of oxygen as determined from a Winkler titration (for ODO mg/L), for instance. Observe the Pre Calibration Value readings and the Data Stability, and when they are Stable, click Apply to accept this calibration point.

Click Complete. View the Calibration Summary screen and QC Score. Click Exit to return to the sensor calibration menu.

NOTE: Carrying out DO mg/L calibrations at values outside the range of $\pm 10\%$ of air saturation is likely to compromise the accuracy specification of the EXO sensor. For highest accuracy, calibrate in % saturation.

Rinse the sonde and sensor(s) in tap or purified water and dry.

SmartQC for Optical Dissolved Oxygen Sensors

Dissolved Oxygen (DO) calculations are derived from polynomial equations based on the K1-K7 coefficients that are provided with each new EXO Dissolved Oxygen sensor cap. Each sensor has been thoroughly tested during the production process to generate these unique calibration coefficients. Calibration of the probe essentially changes these coefficients. The DO SmartQC Score is based on a gain factor, which relates to the magnitude of coefficient change. The gain may drift as the sensor gets older and the optics begin to fade and may also be affected by the degradation of or damage to the unique material that is on the face of the sensor. If a zero-DO calibration is performed, SmartQC also calculates a zero-DO coefficient change.

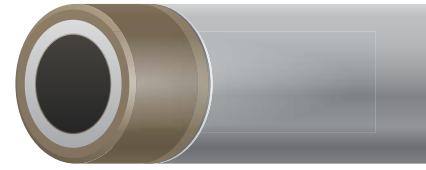

Guidance on interpretation of the SmartQC Score for this sensor is as follows:

-  **Green:** Gain is within acceptable limits. Calibration was performed successfully and resulted in a gain within factory specified limit.

-  **Yellow:** The gain or zero-DO calibration coefficient has drifted a minor amount from the factory specified limits. The sensor is still reporting correctly but adjustments may need to be made. If a user calibration results in a yellow QC Score, perform the following actions:
 1. Thoroughly clean the sensor and ensure that all debris is removed from the surfaces of the sensor. Refer to the [Section 5.9](#) of the manual for additional information on how to properly clean the instrument in order to avoid damaging the sensor.
 2. If the sensor has been left in dry air for longer than eight hours, it must be rehydrated. To rehydrate, soak the DO sensor cap in warm (room temperature) tap water for approximately 24 hours. Following the soak, calibrate the sensor and store it in a moist environment.
 3. Ensure that proper calibration procedures were followed. Typical errors include not allowing enough time for the calibration chamber to come to equilibrium with the atmosphere or the chamber was not of adequate humidity. Time to equilibrate to an air-saturated water chamber may also not have been adequate. It is recommended to allow between 10-15 minutes for equilibration..
 4. Check the lens cap for scratches. If there are scratches, the resulting gain after calibration may change because the amount of membrane remaining on the lens cap has changed.
 5. If a new lens cap was installed,
 - a. ensure that the new calibration coefficients were entered into the sensor using either the handheld or KorEXO software. The software will calibrate the sensor and also compute the QC Score based on the old lens cap coefficients if the values are not changed after installation of the new lens cap.
 - b. perform a Factory Reset Calibration before performing a calibration to revert the gain and zero-DO coefficient back to factory default.
 6. If a zero-DO calibration resulted in a yellow QC Score, it is recommended to create a new zero-DO solution. Depending upon the method used (sparging with nitrogen or sodium sulfite), either ensure that the proper amount of sodium sulfite is fully mixed into the water, or ensure that the gas purge chamber has an adequate amount of time to purge all oxygen from the water.
 7. Sometimes low-quality nitrogen tanks are contaminated with trace amounts of oxygen—check the certificate with your nitrogen source to assure its purity.

If the QC Score returns to yellow, the sensor is still able to be used but the user should monitor this sensor during calibrations for any further drift.

-  **Red:** The gain or zero-DO calibration coefficient has drifted significantly from the factory specified limits and the sensor may not report correct values. If a user calibration results in a red QC Score, perform the following actions:
1. Thoroughly clean the sensor and ensure that all debris is removed from the surfaces of the sensor. Occasionally, thin films from sediment may affix to the lens cap surface and will affect readings and calibrations. Refer to the [Section 5.9](#) of the manual for additional information on how to properly clean in order to avoid damaging the sensor cap.
 2. If the sensor has been left in dry air for longer than eight hours, it must be rehydrated. To rehydrate, soak the DO sensor cap in warm (room temperature) tap water for approximately 24 hours. Following the soak, calibrate the sensor and store it in a moist environment.
 3. Ensure that proper calibration procedures were followed. Gross errors can cause the gain to change significantly from factory default values. Errors in calibration include sealing the calibration cup to the sonde completely, allowing the calibration setup to equilibrate in the sun, or not properly saturating the air environment with water.
 4. Inspect the lens caps for coating loss on the sensor window. If the sensor cap has excessive coating loss to the point that calibration is being affected, replace the sensor lens cap. Re-enter the calibration coefficients, execute a Factory Reset Calibration and perform a calibration on the newly installed sensor lens cap.
 5. Verify that proper calibration coefficients were entered if the sensor lens cap was replaced.
 6. If a zero-DO calibration was performed, perform a Factory Reset Calibration and redo the 2-point calibration procedure. Allow for ample time for the sensor to equilibrate to both zero and 100% saturation values.

If the QC Score returns to red after the above steps were attempted, please contact YSI Technical Support for further assistance.

4.13 fDOM Sensor Overview

The EXO fDOM (Fluorescent Dissolved Organic Matter) sensor detects the fluorescent component of DOM (Dissolved Organic Matter) when exposed to near-ultraviolet (UV) light.

Colored Dissolved Organic Matter

Users might wish to quantify *colored* dissolved organic matter (CDOM) in order to determine the amount of light which is absorbed by stained water and thus is not available for photosynthesis. In most cases, fDOM can be used as a surrogate for CDOM.

Quinine Sulfate

A surrogate for fDOM is quinine sulfate, which, in acid solution, fluoresces similarly to dissolved organic matter. The units of fDOM are quinine sulfate units (QSUs) where 1 QSU = 1 ppb quinine sulfate and thus quinine sulfate is really an indirect surrogate for the desired CDOM parameter.

The EXO fDOM sensor shows virtually perfect linearity ($R^2=1.0000$) on serial dilution of a colorless solution of quinine sulfate. However, on serial dilution of stained water field samples, the sensor shows some underlinearity. The point of underlinearity in field samples varies and is affected by the UV absorbance of the DOM in the water. Testing shows that underlinearity can occur at fDOM concentrations as low as 50 QSU. This factor means that a field sample with an fDOM reading of 140 QSU will contain significantly more than double the fDOM of a sample that reads 70 QSU. This effect—good linearity in colorless quinine sulfate solution, but underlinearity in stained field samples—is also exhibited by other commercially available fDOM sensors and thus the performance of the EXO sensor is likely to be equivalent or better than the competition while providing the advantages of easy integration into a multiparameter package and automatic mechanical cleaning when used in monitoring studies with an EXO2 sonde.

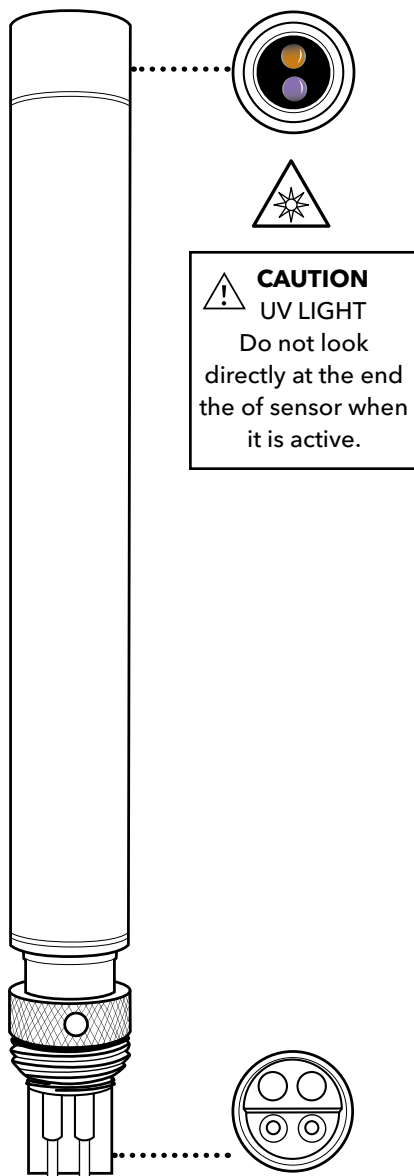

599104-01

Specifications

Units	Quinine Sulfate Units (QSU), ppb
Temperature	
<i>Operating</i>	-5 to +50°C
<i>Storage</i>	-20 to +80°C
Range	0 to 300 ppb QSU
Response	T63<2 sec
Resolution	0.01 ppb QSU
Sensor Type	Optical, fluorescence
Linearity	$R^2>0.999$ for serial dilution of 300 ppb Quinine Sulfate solution
Detection Limit	0.07 ppb QSU
Optics: Excitation	365±5 nm
Emission	480±40 nm

4.14

fDOM Calibration Standards

Quinine Sulfate Solution for fDOM Sensor

⚠ WARNING: Before using a quinine sulfate reagent (solid or solution) or sulfuric acid reagent, read the safety instructions provided by the supplier. Take extra precautions when making dilutions of concentrated sulfuric acid, as this reagent is particularly dangerous. Remember that only trained personnel should handle chemicals.

Preparation

Use the following procedure to prepare a 300 µg/L solution of quinine sulfate (300 QSU) that can be used to calibrate the EXO fDOM sensor for field use:

1. Purchase solid quinine sulfate dihydrate (CAS# 6119-70-6) with a high purity (>99%).
2. Purchase 0.1 N (0.05 M) sulfuric acid (CAS# 7664-93-3), to avoid the hazards of diluting concentrated sulfuric acid to make this reagent.
3. Weigh 0.100 g of solid quinine sulfate dihydrate and quantitatively transfer the solid to a 100-mL volumetric flask. Dissolve the solid in about 50 mL of 0.05 M (0.1 N) sulfuric acid (H_2SO_4), dilute the solution to the mark of the volumetric flask with additional 0.05 M sulfuric acid, and mix well by repeated inversion. This solution is 1000 ppm in quinine sulfate (0.1%).
4. Transfer 0.3 mL of the 1000 ppm solution to a 1000 mL volumetric and then fill the flask to the top graduation with 0.05 M sulfuric acid. Mix well to obtain a solution of 300 µg/L (300 QSU or 100 RFU).
5. Store the concentrated standard solution in a darkened glass bottle in a refrigerator to retard decomposition. The dilute standard prepared in the previous step should be used within 5 days of preparation and should be discarded immediately after exposure to EXO's metal components.

Degradation of quinine fluorescence by copper and chloride

NOTICE: Exposure of the quinine sulfate solution to any copper-based component of the EXO sonde and sensors (primarily the wiper assembly) will begin to degrade the solution significantly within minutes. Quinine fluorescence is also degraded by the presence of chloride or halide ions, found in estuarine or seawater, conductivity standards, and Zobell solution. Thus, clean your sensors thoroughly and perform your calibration as quickly as possible on immersion of the sensors into the quinine sulfate solution. Discard the used standard. When quinine sulfate standards are required in the future, perform another dilution of the concentrated solution.

Effect of temperature on fluorescence

The intensity of the fluorescence of many dyes shows an inverse relationship with temperature. This effect must be accounted for when calibrating the EXO fDOM sensor with quinine sulfate solution. Enter the QSU or RFU value from the table below that corresponds to the temperature of the standard.

Temp (°C)	RFU	QSU	Temp (°C)	RFU	QSU
30	96.4	289.2	18	101.8	305.4
28	97.3	291.9	16	102.7	308.1
26	98.2	294.6	14	103.6	310.8
24	99.1	297.3	12	104.6	313.8
22	100	300	10	105.5	316.5
20	100.9	302.7	8	106.4	319.2

4.15

fDOM Calibration

Review the basic calibration description in [Section 4.2](#).

Before calibrating, be certain that the sensing window is clean (cleaning instructions, [Section 5.6](#)).

This procedure calibrates fDOM RFU or fDOM QSU/ppb. If the user has both units selected, then this procedure must be performed twice, once for each unit, to completely calibrate the parameter.

For 2-point calibrations, the first standard must be clear water (0 µg/L). The second standard should be a 300 µg/L quinine sulfate solution. For detailed instructions for mixing this solution, see [Section 4.14](#).

NOTICE: Do not leave sensors in quinine sulfate solution for a long time. A chemical reaction occurs with the copper on the sonde (wiper assembly, sonde bulkhead, copper tape) that degrades the solution and causes it to drift. Also, start with very clean sensors, as the presence of chloride and halide ions (from estuarine or seawater, conductivity standards, and Zobell solution) can compromise QS fluorescence.

QSU – 1- or 2-point

Pour the correct amount of clear deionized or distilled water into the calibration cup. Immerse the probe end of the sonde in the water.

In the Calibrate menu, select fDOM, then select QSU/ppb. Select either a 1- or 2-point calibration. Enter 0 for first standard value and 300 µg/L for second standard value.

Observe the Pre Calibration Value readings and the Data Stability, and when they are Stable, click Apply to accept this calibration point.

Remove the central wiper from the EXO2 sonde before proceeding to the next step.

Next place the sensors in the correct amount of 300 µg/L quinine sulfate standard in the calibration cup. Click Add Another Cal Point in the software. Observe the Pre Calibration Value readings and the Data Stability. While stabilizing, verify that no air bubbles reside on the sensing face of the sensor. If there are bubbles, gently shake or move the sensor to dislodge. When data are Stable, click Apply to accept this calibration point.

Click Complete. View the Calibration Summary screen and QC Score. Click Exit to return to the sensor calibration menu, and then the back arrows to return to main Calibrate menu.

RFU – 1- or 2-point

Pour the correct amount of clear deionized or distilled water into the calibration cup. Immerse the probe end of the sonde in the water.

In the Calibrate menu, select fDOM, then select RFU. Select either a 1- or 2-point calibration. Enter 0 for first standard value and 100 RFU for second standard value.

Observe the Pre Calibration Value readings and the Data Stability, and when they are Stable, and when they are Stable, click Apply to accept this calibration point.

Remove the central wiper from the EXO2 sonde before proceeding to the next step.

Next place the sensors in the 300 µg/L quinine sulfate standard in the calibration cup. Click Add Another Cal Point in the software. Observe the Pre Calibration Value readings and the Data Stability. While stabilizing, verify that no air bubbles reside on the sensing face of the sensor. If there are bubbles, gently shake or move the sensor to dislodge. When data are Stable (or data shows no significant change for approximately 40 seconds), click Apply to accept this calibration point.

Click Complete. View the Calibration Summary screen and QC Score. Click Exit to return to the sensor calibration menu. Rinse the sonde in tap or purified water and dry the sonde. Discard the used standard.

SmartQC for fDOM Sensors (RFU or QSU)

The SmartQC Score for fDOM is based on a gain factor and an offset factor. Both of these values may change as the sensor and the optics age.

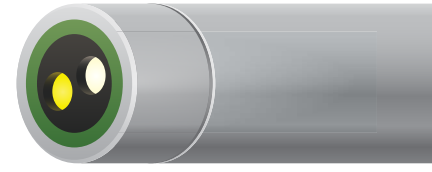

Guidance on interpretation of the SmartQC Score for this sensor is as follows:

 **Green:** Gain and offset are within acceptable limits. Calibration was performed successfully and results are within factory specified limits.

 **Yellow:** The sensor gain or offset is near the threshold of calibration limits. If a user calibration results in a yellow QC Score, perform the following actions:

1. Perform a Factory Reset Calibration and complete a recalibration.
 - a. If performing a 1-point calibration, use fresh, clear water.
 - b. If performing a 2-point calibration, use fresh, clear water and freshly made quinine sulfate solution.
2. Ensure that the standard value was entered correctly. Calibration of fDOM is temperature-dependent; make sure the appropriate value from the table in [Section 4.14](#) was entered during calibration for either RFU or QSU.
3. Ensure that the sensor is free of contamination. Refer to [Section 5.6](#) for additional information on how to properly clean the sensor in order to avoid damage.
4. Ensure the copper tape and the central wiper brush are removed from the sonde. Copper quenches fluorescence of quinine sulfate, which will interfere with the calibration.

If the QC Score returns to yellow, the sensor is still able to be used, but the user should monitor this sensor during calibrations for any further drift.

 **Red:** The sensor gain or offset are outside of factory specified limits. If a user calibration results in a red QC Score, follow the same steps described above for a yellow QC Score.

If the QC Score remains red, please contact YSI Technical Support for further assistance.

4.16 ISEs: Ammonium, Nitrate, & Chloride Sensors Overview

NOTE: Ammonium, nitrate, and chloride ion-selective electrodes (ISEs) should be used in freshwater applications only at depths of less than 55 feet (17 meters) and less than 25 psi.

The ammonium and nitrate sensors use a silver/silver chloride wire electrode in a custom filling solution. The internal solution is separated from the sample medium by a polymer membrane, which selectively interacts with ammonium or nitrate ions. When the sensor is immersed in water, a potential is established across the membrane that depends on the relative amounts of ions in the sample and the internal solution. This potential is read relative to the Ag/AgCl reference electrode. (continued)

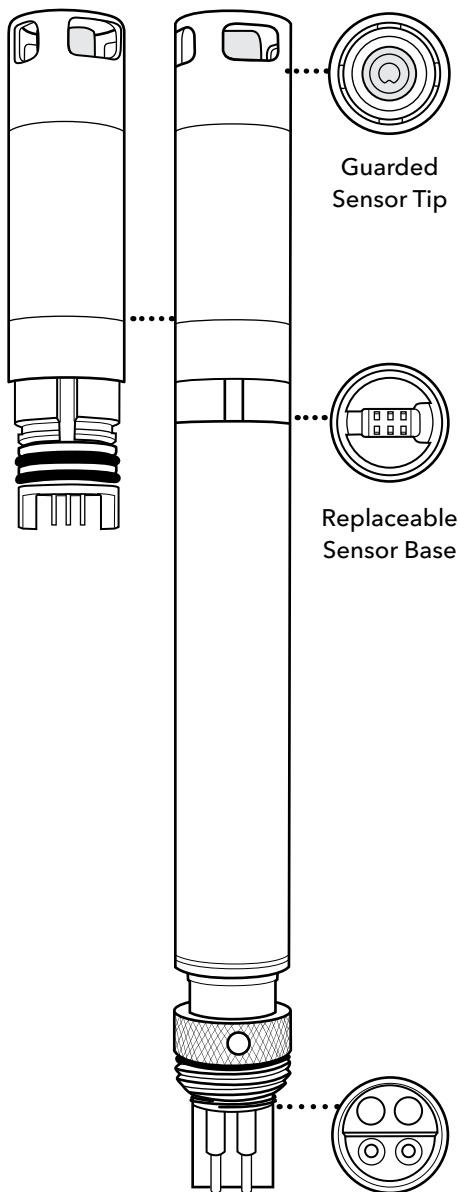

599709, 599710, 599711;
599743-01, 599744-01, 599745-01 modules

Specifications

Ammonium - NH₄

Units	mg/L-N, millivolts
Temperature	
Operating	0 to 30°C
Storage	0 to 30°C
Depth	0 to <55 ft (0 to <17 m)
Range	0 to 200 mg/L-N
Accuracy	±10% of reading or ±2 mg/L-N, whichever is greater
Response	T63<30 sec
Resolution	0.01 mg/L
Sensor Type	Ion-selective electrode
Conductivity	<1500 µS/cm

Nitrate - NO₃

Units	mg/L-N, millivolts
Temperature	
Operating	0 to 30°C
Storage	0 to 30°C
Depth	0 to <55 ft (0 to <17 m)
Range	0 to 200 mg/L-N
Accuracy	±10% of reading or ±2 mg/L-N, whichever is greater
Response	T63<30 sec
Resolution	0.01 mg/L
Sensor Type	Ion-selective electrode
Conductivity	<1500 µS/cm

(Specs. continued)

Specifications *(continued)*

Chloride - Cl

Units	mg/L-Cl, millivolts
Temperature	
<i>Operating</i>	0 to 30°C
<i>Storage</i>	0 to 30°C
Depth	0 to <55 ft (0 to <17 m)
Range	0 to 18000 mg/L-Cl
Accuracy	±15% of reading or ±5 mg/L-Cl, whichever is greater
Response	T63<30 sec
Resolution	0.01 mg/L
Sensor Type	Ion-selective electrode
Salinity	30 psu

NOTE: Qualification testing for chloride was performed in a stirred calibration solution. Due to the solid state nature of the chloride ISE, the sensor exhibits moderate flow dependence. Mitigation can be achieved by stirring during calibration.

The chloride sensor uses a solid-state membrane attached to a conductive wire. This sensor operates in a similar fashion to the ammonium and nitrate sensors.

For all ISEs, the linear relationship between the logarithm of the ammonium, nitrate or chloride activity and the observed voltage, as predicted by the Nernst equation, is the basis for the determination.

Ammonium is calculated from the pH, salinity, and temperature readings. If a pH sensor is not in use, the instrument will assume the sample is neutral (pH 7) for the calculation. If a conductivity sensor (salinity) is not in use, the instrument will use the salinity correction value entered in the ammonium sensor calibration screen for the calculation.

NOTE: A pH sensor must be installed in order to receive representative ammonia (NH₃) readings (assuming all sensors are calibrated and in good working order).

Replaceable Sensor Module

The EXO ammonium, chloride, and nitrate sensors have a unique design that incorporates a user-replaceable sensor tip (module) and a reusable sensor base that houses the processing electronics, memory, and wet-mate connector. This allows users to reduce the costs associated with these sensors by only replacing the relatively inexpensive module periodically and not the more costly base.

The connection of the module to the sensor base is designed for one connection only and the procedure must be conducted in an indoor and dry environment. Once installed the module cannot be removed until you are prepared to replace it with a new module.

See [Section 5.14](#) for detailed instructions.

The typical life expectancy of an ISE sensor is three to six months, depending on use.

Precautions

- ISEs are intended for sampling purposes and **must** be calibrated frequently due to sensor drift.
- ISEs can be used in long-term deployments for qualitative trends. Use with an EXO wiper will deform the brush over time and may require more frequent brush replacement. The brush deformation may intensify with the fouling present in the monitored environment.
- ISE sensors only come in guarded configurations. Customers should not remove the plastic guard that protects the ISE membrane.
- For long-term deployments, sensor data should be compared to that of grab samples throughout the monitoring period to note drift.

For a full list of precautions see the end of [Section 4.17](#).

4.17

ISEs: Ammonium, Nitrate, & Chloride Calibration

This procedure calibrates the EXO ammonium, chloride, or nitrate sensor. The sensors can be calibrated to one, two or three points. The 3-point calibration method assures maximum accuracy when the temperature of the media to be monitored cannot be anticipated; we strongly recommend a 3-point calibration for best performance of ISE sensors. Review the basic calibration description in [Section 4.2](#).

The temperature response of ion-selective electrodes is not as predictable as that of pH sensors. Therefore, be sure to carry out a 3-point calibration the first time you use the sensor. This will provide a default setting for the effect of temperature on your sensor. After this initial calibration, you can use the less time-consuming 2-point and 1-point routines to update the 3-point calibration. However, we strongly recommend a new 3-point calibration after each deployment of 30 days or longer.

Due to the nature of ion-selective electrodes, it is recommended that they be used for sampling purposes for the greatest accuracy. Using an ISE in long-term deployments is possible, but it's important to note that drift occurs over an extended period of time. Collecting grab samples from the site is encouraged to correct for drift. Additionally, sample readings should be taken after sensors have fully stabilized. Calibrating in a continuously stirred solution from 1 to 5 minutes has shown to improve sensor performance. For best performance sensors should be calibrated as close to the expected field conditions as possible.

For more ISE precautions, drift, and accuracy notes please see [ISE Precautions](#) at the end of this section.

Calibration Options (Ammonium Example)

1-point

Perform the 1-point option only if you are adjusting a previous calibration. If a 2-point or 3-point calibration has been performed previously, you can adjust the calibration by carrying out a 1-point calibration.

2-point

Perform the 2-point option to calibrate the ammonium sensor using only two calibration standard solutions. In this procedure, the ammonium sensor is calibrated using a 1 mg/L NH_4^+ -N and 100 mg/L NH_4^+ -N calibration standard solutions. A 2-point calibration procedure (as opposed to a 3-point procedure) can save time if the temperature range of the media being monitored is known and stable.

3-point

Perform the 3-point option to calibrate the ammonium sensor using three calibration standard solutions, two at ambient temperature and one at a temperature substantially different from ambient. The 3-point calibration method should be used to assure maximum accuracy when the temperature of the media to be monitored cannot be anticipated. 3-point calibration temperatures should span the range of interest, for example 20°C and 2°C for "cold" and 20°C and 30°C for "hot". The procedure for this calibration is the same as for a 2-point calibration, but the software will prompt you to place the sensor in the additional calibration standard solution to complete the 3-point procedure. Be certain that the calibration standard solution and sensor are thermally equilibrated prior to proceeding with the calibration. The recommended order of calibration standards is (1) 1 mg/L NH_4^+ -N standard at ambient temperature, (2) 100 mg/L NH_4^+ -N standard at ambient temperature, and (3) 1 mg/L NH_4^+ -N standard at a different temperature (usually lower) than ambient, $\pm 10^\circ\text{C}$ minimum.

- To save time during calibration, chill/heat a sufficient amount of 1 mg/L NH_4^+ -N calibration standard solution prior to the start of calibration.

Ammonium Pre-calibration

Soaking

EXO Ammonium Sensors are shipped in a dry container. Before initial use the sensor membrane needs to be soaked in 100 mg/L ammonium standard solution (YSI part #003843). Most users find it useful to soak the sensors overnight; shorter soaking times may be used if the sensor output is monitored and is fully stabilized.

In addition to initially soaking the sensor, users may also see improved performance if the ammonium sensor is soaked in 100 mg/L solution after field deployments. This process helps remove any interfering ions from the sensor membrane.

After the activation process the sensor should be rinsed thoroughly and the following calibration precautions should be observed.

The ammonium sensor should be calibrated using solutions of known total ammonium-nitrogen content or YSI Standards.

part #003841	1 mg/L
part #003842	10 mg/L
part #003843	100 mg/L

If a two point calibration protocol is used, the temperature of the standards should be as close as possible to that of the environmental medium to be monitored. The recommended calibration procedure is one involving three solutions. Two of the solutions should be at ambient temperature while the third should be at least 10°C different from ambient temperature. This protocol minimizes the effects of taking readings at temperatures that are significantly different from ambient laboratory temperatures.

Calibration Tip

Exposure to the high ionic content of pH buffers can cause a significant, but temporary, drift in the Ammonium, Nitrate, and Chloride sensors. Therefore, when calibrating the pH/ORP probe, YSI recommends that you use one of the following methods to minimize errors in the subsequent readings:

A. When calibrating pH, remove ISE modules from the sonde bulkhead and plug the ports. After pH calibration is complete, replace the ISE sensors and proceed with their calibration with no stabilization delay.

B. Calibrate pH first, immersing all of the probes in the pH buffers. After calibrating pH, place the probes in 100 mg/L nitrate or ammonium standard or 1000 mg/L chloride standard and monitor the reading. Usually, the reading starts low and may take as long as 30 minutes to reach a stable value. When it does, proceed with calibration of the ISE sensor.

Despite the potential problems with interference when using ISEs, it is important to remember that almost all interfering species produce an artificially high ammonium reading. Thus, if the sonde indicates the presence of only small quantities of ammonium, it is unlikely that the reading is erroneously low because of interference. Unusually high ammonium readings (which could be due to interfering ions) should be confirmed by laboratory analysis after collection of water samples.

Ammonium 3-point

NOTICE: Do not expose electrodes to high-conductivity solutions. Exposure will reduce data quality and response of the sensors. During calibration of other sensors, remove the ISEs to avoid exposing them to conductivity standards, Zobell solution, pH buffer, or any solution with significant conductivity.

In the Calibrate menu, select Ammonium, then select Calibrate.

Pour a sufficient amount of 1 mg/L NH_4^+ -N calibration standard solution at ambient temperature in a clean and dry or pre-rinsed calibration cup. Carefully immerse the sensor end of the sonde into the solution, making sure the sensor's tip is in solution by at least 1 cm. Allow at least 1 minute for temperature equilibration before proceeding.

Observe the Pre Calibration Value readings and the Data Stability, and when they are Stable, click Apply to accept this calibration point.

Rinse the sensors in deionized water between changes of the calibration solutions. Pour a sufficient amount of 100 mg/L of NH_4^+ -N calibration standard solution at ambient temperature into a clean, dry or pre-rinsed calibration cup and carefully immerse the sensor end of the sonde into the solution. Allow at least 1 minute for temperature equilibration before proceeding.

Click Add Another Cal Point in the software. Observe the Pre Calibration Value readings and the Data Stability, and when they are Stable, click Apply to accept this calibration point.

Rinse the sensors in deionized water between changes of the calibration solutions. Immerse the sensor end of the sonde in the pre-chilled 1 mg/L NH_4^+ -N calibration standard solution ensuring that the temperature is at least 10°C different than ambient. Allow at least 1 minute for temperature equilibration before proceeding.

Click Add Another Cal Point in the software. Observe the Pre Calibration Value readings and the Data Stability, and when they are Stable, click Apply to accept this calibration point.

Click Complete. View the Calibration Summary screen and QC Score. Click Exit to return to the sensor calibration menu

Rinse the sonde in tap or purified water.

Nitrate 3-point

The calibration procedure for nitrate is identical to the procedure for ammonium, except that the calibration standard solution values are in mg/L NO_3^- -N instead of NH_4^+ -N.

Chloride 3-point

The calibration procedure for chloride is identical to the procedure for ammonium and nitrate, except that the calibration standard solution values are in mg/L Cl⁻ instead of NH_4^+ -N or NO_3^- -N. YSI recommends that the user employ standards for chloride that are 10 times greater than for ammonium and nitrate and that span the expected deployment conditions. Typical calibration ranges are 10mg/L Cl⁻ and 1000mg/L Cl⁻ or 1000mg/L Cl⁻ and 18000mg/L Cl⁻.

Chloride Standard for Chloride Sensor

 **WARNING:** Read and follow all the safety instructions and MSDS documentation supplied with the chemical before proceeding. Remember that only trained personnel should handle hazardous chemicals.

Preparation

Use the following procedure to prepare 10 and 1000 mg/L chloride reagents for the EXO Chloride sensor. (Nitrate and Ammonium standards can be purchased from YSI or other laboratory supply companies.)

1000 mg/L Standard

1. Purchase solid sodium chloride from a supplier.
2. Accurately weigh 1.655 grams of anhydrous sodium chloride and transfer into a 1000 mL volumetric flask.
3. Add 0.5 grams of anhydrous magnesium sulfate to the flask.
4. Add 500 mL of water to the flask, swirl to dissolve all of the reagents. Dilute to the volumetric mark with water. Mix well by repeated inversion and then transfer the 1000 mg/L standard to a storage bottle.

Alternatively, simply add 0.5 grams of magnesium sulfate to a liter of a 1000 mg/L chloride standard from a certified supplier.

10 mg/L Standard

1. Accurately measure 10 mL of the above 1000 mg/L standard solution into a 1000 mL volumetric flask.
2. Add 0.5 grams of anhydrous magnesium sulfate to the flask.
3. Add 500 mL of water, swirl to dissolve the solid reagents, and then dilute to the volumetric mark with water. Mix well by repeated inversion and then transfer the 10 mg/L standard to a storage bottle.
4. Rinse the flask extensively with water prior to its use in the preparation of the 1000 mg/L standard.

Sensor Drift

The ion-selective electrodes have the greatest tendency to exhibit calibration drift over time. This drift should not be a major issue for sampling studies where the instrument can be frequently calibrated. However, if the sensor is used in longer-term deployments, drift is almost certain to occur. The extent of the drift will vary depending on the age of the probe, the flow rate at the site, and the quality of the water. For all monitoring studies using ion-selective electrodes, the user should acquire a few grab samples during the deployment for analysis in the laboratory or with another sensor that has been recently calibrated.

Sensor Accuracy Specifications

The typical accuracy specification for the sensors ($\pm 10\%$ of reading or 2 mg/L whichever is greater for ammonium and nitrate and $\pm 15\%$ of reading or 5 mg/L whichever is greater for chloride) refer to sampling applications where only minimal time has elapsed between calibration and field use.

To maintain accuracy specifications for EXO sensor, we recommend that users calibrate sensors in the lab in standards with temperatures as close to the ambient temperature of the field water as possible.

All ion-selective electrodes are subject to the interaction of species with the sensor membrane, which are similar in nature to the analyte. These interfering species thus include other halide ions (fluoride, bromide, and iodide) as well as other anions.

Despite the potential problems with interference when using ISEs, it is important to remember that almost all interfering species produce an artificially high reading. Thus, if the sensor indicates the presence of only small quantities, it is unlikely that the reading is erroneously low because of interference. Unusually high readings (which could be due to interfering ions) should be confirmed by laboratory analysis after collection of water samples.

ISE Precautions

Ion-selective electrodes may not stabilize as rapidly as pH sensors. Be sure to allow plenty of time for the readings to come to their final values during all calibration routines.

Ion-selective electrodes generally drift more than pH sensors. To check for this drift, read the sensor's value in a calibration standard solution at the end of each deployment.

Ammonium and nitrate standards are good growth media for a variety of microorganisms. This growth can significantly reduce the nitrogen content of your standards, an effect that is particularly important for the 1 mg/L solution. It is best to use new standards for each calibration, but if you decide to save your solutions for reuse, we recommend refrigerated storage to minimize the growth of these organisms.

Remember that the ammonium, nitrate, and chloride sensors will take longer to stabilize after exposure to high conductivity solutions such as a pH buffer. To accelerate the recovery process, soak the sensor in 100 mg/L ammonium or nitrate standard solution or 1000 mg/L Cl⁻ standard solution for a few minutes after exposure. In addition, be particularly careful that readings are stable during subsequent calibrations.

Of all the sensors available on the sonde, ion selective electrodes have the greatest tendency to exhibit calibration drift over time. This drift should not be a major problem for sampling studies where the instrument can be frequently calibrated. However, if an ammonium sensor is used in a longer-term deployment study with the sonde, the user should be aware that drift is almost certain to occur. The extent of the drift will vary depending on the age of the probe, the flow rate at the site, and the quality of the water. For all monitoring studies using ion selective electrodes, the user should acquire a few "grab samples" during the course of the deployment for analysis in the laboratory by chemical means or with another ammonium sensor which has been recently calibrated. Remember that the typical accuracy specification for the sensor ($\pm 10\%$ of the reading or 2 mg/L, whichever is larger) refers to sampling applications where only minimal time has elapsed between calibration and field use.

Many users find it useful to swap ISEs after 30 days of deployment with freshly calibrated sensors. On the EXO platform the calibration is retained inside the sensor, so they can be calibrated in the lab and installed in the field.

SmartQC for ISE Sensors

ISE sensor algorithms are derived from three independent coefficients (called J, S, and A) as well as mV, temperature and salinity. J, S, and A are the calibrated coefficients and S specifically is concentration of the analyte being detected by the sensor. S is the coefficient whose gain factor is the basis of SmartQC for these sensors.

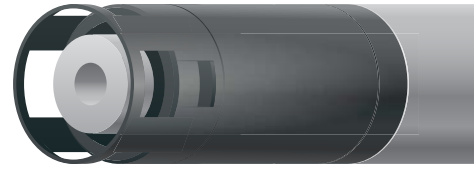

Guidance on interpretation of the SmartQC Score for this sensor is as follows:

 **Green:** Gain and offset are within acceptable limits. Calibration was performed successfully and results are within factory specified limits.

 **Yellow:** The S gain is near the threshold of calibration limits. If a user calibration results in a yellow QC Score, perform the following actions:

1. Perform a Factory Reset Calibration and re-do the calibration.
2. If the sensor had not been properly stored it may be necessary to rehydrate the reference junction, as described in [Section 5.13](#).
3. Pre-calibration soaking is advisable for ISEs, especially if a non-green SmartQC Score occurs. Pre-soak the ISE tip in its higher concentration calibration solution for at least 12 hours prior to trying another calibration.
4. During calibration, ensure that the standard solutions were thermally equilibrated, meaning that the temperature was stable and not changing during calibration. Sometimes putting the solutions in a water bath can help ensure this.
5. Ensure that the standard value was entered correctly.
6. It is imperative that the sensors, calibration cup, and sonde guard are all very clean when calibrating.
7. Since these modules have a relatively short lifespan, a prior user may have entered an expiration date into the software for when the sensor should be replaced. Check to see if that date is near.
8. Ensure that the sensor is free of debris. Refer to [Section 5.13](#) for additional information on how to properly clean the sensor in order to avoid damage.

If the QC Score remains yellow, the sensor is still able to be used, but ISE's are the one case where a yellow-scored sensor should not be used for a continuous deployment, because the period of time before it would become red is probably short. It can be used for spot sampling, and should be recalibrated before each day's use.

 **Red:** The S gain is significantly outside of factory specified limits. If a user calibration results in a red QC Score, follow the same steps described above for a yellow QC Score. If the QC Score remains red, it is likely time to replace the sensor module.

If replacement of the module does not return the sensor to a Green QC Score, please contact YSI Technical Support for further assistance.

4.18 pH and ORP Sensor Overview

Users can choose between a pH sensor or a combination pH/ORP sensor to measure these parameters. pH describes the acid and base characteristics of water. A pH of 7.0 is neutral; values below 7 are acidic; values above 7 are alkaline. ORP designates the oxidizing-reducing potential of a water sample and is useful for water which contains a high concentration of redox-active species, such as the salts of many metals and strong oxidizing (chlorine) and reducing (sulfite ion) agents. However, ORP is a non-specific measurement—the measured potential is reflective of a combination of the effects of all the dissolved species in the medium. Users should be careful not to overinterpret ORP data unless specific information about the site is known.

(continued)

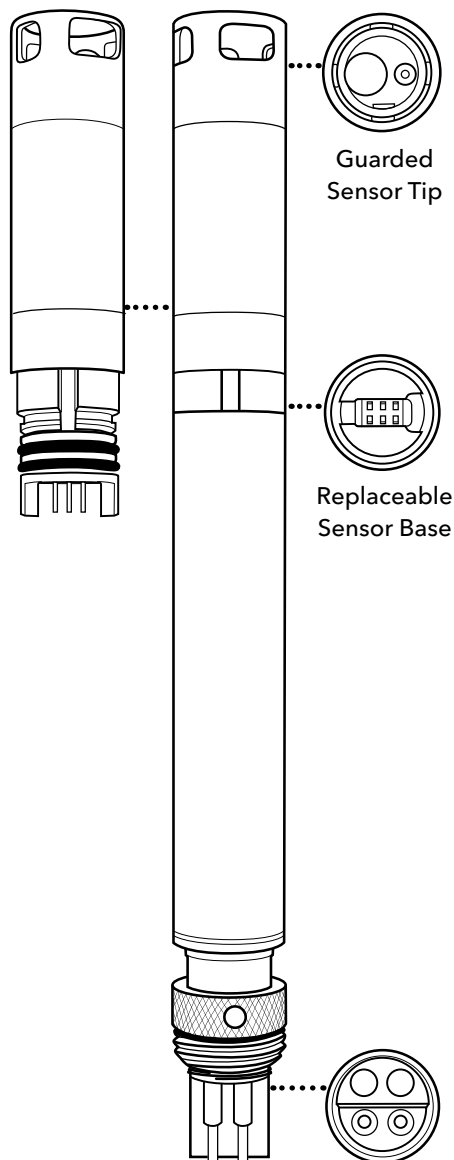

577601, 577602, 577611, 577612;
577603-01, 577603-02, 577613-01,
577613-02 modules

Specifications

pH

Units	pH units
Temperature	
<i>Operating</i>	-5 to +50°C
<i>Storage</i>	0 to 60°C
Range	0 to 14 units
Accuracy	±0.1 pH units within ±10°C of calibration temperature; ±0.2 pH units for entire temp range
Response	T63<3 sec
Resolution	0.01 units
Sensor Type	Glass combination electrode

ORP

Units	millivolts
Temperature	
<i>Operating</i>	-5 to +50°C
<i>Storage</i>	0 to 60°C
Range	-999 to +999 mV
Accuracy	±20 mV in Redox standard solution
Response	T63<5 sec
Resolution	0.1 mV
Sensor Type	Platinum button

Replaceable Sensor Module

The EXO pH and pH/ORP sensors have a unique design that incorporates a user-replaceable sensor tip (module) and a reusable sensor base that houses the processing electronics, memory, and wet-mate connector. This allows users to reduce the costs associated with pH and pH/ORP sensors by only replacing the relatively inexpensive module periodically and not the more costly base.

The connection of the module to the sensor base is designed for one connection only and the procedure must be conducted in an indoor and dry environment. Once installed the module cannot be removed until you are prepared to replace it with a new module. See [Section 5.14](#) for detailed instructions.

Users must order either a pH or pH/ORP sensor. Once ordered the sensor is *only* compatible with like-model sensor modules. For example, if a pH sensor is purchased initially, then the user must order a replaceable pH sensor module in the future; it cannot be replaced with a pH/ORP module.

Electrodes

EXO measures pH with two electrodes combined in the same probe: one for hydrogen ions and one as a reference. The sensor is a glass bulb filled with a solution of stable pH (usually 7) and the inside of the glass surface experiences constant binding of H^+ ions. The outside of the bulb is exposed to the sample, where the concentration of hydrogen ions varies. The resulting differential creates a potential read by the meter versus the stable potential of the reference.

The ORP of the media is measured by the difference in potential between an electrode which is relatively chemically inert and a reference electrode. The ORP sensor consists of a platinum button found on the tip of the probe. The potential associated with this metal is read versus the Ag/AgCl reference electrode of the combination sensor that utilizes gelled electrolyte. ORP values are presented in millivolts and are not compensated for temperature.

Signal Quality

Signal conditioning electronics within the pH sensor module improve response, increase stability, and reduce proximal interference during calibration. Amplification (buffering) in the sensor head is used to eliminate any issue of humidity in the front-end circuitry and reduce noise.

4.19 pH Calibration

1-point

Select the 1-point option to calibrate the pH probe using one calibration standard.

NOTE: While a 1-point pH calibration is possible, YSI recommends using a 2 or 3-point calibration for greater accuracy.

2-point

Select the 2-point option to calibrate the pH probe using two calibration standards. In this procedure, the pH sensor is calibrated with a pH 7 buffer and a pH 10 or pH 4 buffer depending upon your environmental water. A 2-point calibration can save time (versus a 3-point calibration) if the pH of the media to be monitored is known to be either basic or acidic.

3-point

Select the 3-point option to calibrate the pH probe using three calibration standards. In this procedure, the pH sensor is calibrated with a pH 7 buffer and both the pH 10 and the pH 4. The 3-point calibration method assures maximum accuracy when the pH of the media to be monitored cannot be anticipated.

Review the basic calibration description in [Section 4.2](#).

Pour the correct amount of pH buffer in a clean and dry or pre-rinsed calibration cup. Carefully immerse the probe end of the sonde into the solution, making sure the sensor's glass bulb is in solution by at least 1 cm. Allow at least 1 minute for temperature equilibration before proceeding.

In the Calibrate menu, select pH or pH/ORP, then select Calibrate.

NOTE: Observe the temperature reading above the standard value. The actual pH value of all buffers varies with temperature.

Enter the correct value from the bottle label for your calibration temperature for maximum accuracy. For example, the pH of one manufacturer's pH 7 Buffer is 7.00 at 25°C, but 7.02 at 20°C.

If no temperature sensor is installed, user can manually update temperature by entering a value.

Observe the Pre Calibration Value readings and the Data Stability, and when they are Stable, click Apply to accept this calibration point. Click Add Another Cal Point in the software.

Rinse the sensor in deionized water. Pour the correct amount of the next pH buffer standard into a clean, dry or pre-rinsed calibration cup, and carefully immerse the probe end of the sonde into the solution. Allow at least 1 minute for temperature equilibration before proceeding.

Repeat the calibration procedure and click Apply when the data are stable. Rinse the sensor and pour the next pH buffer, if necessary. Repeat calibration procedure for the third point and click Apply when data are stable.

Click Complete. View the Calibration Summary screen and QC Score. Click Exit to return to the sensor calibration menu, and then the back arrows to return to main Calibrate menu.

Rinse the sonde and sensors in tap or purified water and dry.

SmartQC for pH Sensors

The SmartQC Score for pH is based on both a gain and an offset. The offset calculation is based on the millivolts recorded during sensor calibration.

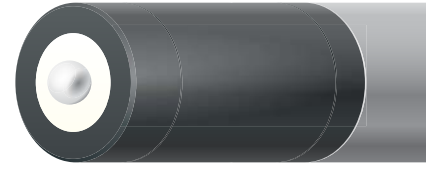

Guidance on interpretation of the SmartQC Score for this sensor is as follows:

 **Green:** Gain and offset are within acceptable limits. Calibration was performed successfully and results are within factory specified limits.

 **Yellow:** Either the gain or the offset is near the threshold of factory specified limits. If a user calibration results in a yellow QC Score, perform the following actions:

1. Ensure that all debris is removed from the surfaces of the sensor. Refer to [Section 5.12](#) for information on proper sensor cleaning in order to avoid damaging the sensor.
2. Verify that there are no cracks or visual damage to the glass bulb.
3. A yellow score can result from a contaminated standard; ensure that all buffers are clear (not cloudy) and free of debris, and that the calibration cup was clean.
4. A Factory Reset Calibration should be performed.
5. The electrolyte solution inside the sensor may be partially depleted which causes the millivolt values to drift over the range of calibration. This is not a user-addressable problem, but to prevent it make sure that sensor modules are stored in the same bottle of solution that was shipped with the new modules. Avoid storage of sensor modules in distilled or deionized water.
6. If the sensor is new, make sure that there are no air bubbles in the pH bulb. Sensors actually do have air in the reference solution, but if the sensor is in the upright position, as it should be during calibration, an air bubble should not be in the bulb. If air bubbles are found, shake the sensor gently to encourage electrolyte solution to flow into the bulb and the air to rise to the top (where it will not be visible).
7. Check the delta slope and mV per decade. Generally, the delta slope should be ≥ 165 mV, and the mV per decade should not deviate by more than 5 units from an ideal of 59.16 (assumes the calibration was performed at or near 25°C). See "Additional Information" below.

If the QC Score returns to yellow, the sensor (or module) is still able to be used but one should be cautious if a long-term deployment is planned. With a yellow QC Score it is more acceptable to use the sensor for discrete sampling because the mV value can be easily monitored under those conditions. In either case, the user should monitor this sensor during calibrations and periodic calibration checks for any further drift. Finally, the sensor could be reconditioned by soaking it in a bleach solution and then an HCl solution ([Section 5.12](#)). Persistent yellow QC Scores are a sign that the time to replace the sensor module may be approaching.

 **Red:** The gain or offset is outside of factory specified limits. If a user calibration results in a red QC Score, follow the same steps described above for a yellow QC Score. If the score remains red then replace the sensor module with a new module, perform a Factory Reset Calibration, and calibrate the new module with fresh buffers.

If the QC Score remains red after the Factory Reset Calibration and recalibration, or after replacement of the module and performing a calibration, please contact YSI Technical Support for further assistance. Further if upon replacement with a new module the QC Score is yellow, contact YSI Technical Support.

Additional QC Information for pH

The calibration worksheet provides information that can be useful for assessing performance of the pH modules with age. Two useful parameters shown there are the "delta slope" and the "mV per decade." In general the practice is to not use a pH module where the delta slope is less than 165 mV, and the mV per decade deviates by more than 5 units from an ideal of 59.16. However, these ranges assume a calibration was performed at or near to 25°C. For users who wish to better understand the underlying principles for these guidelines, and perhaps to establish their own acceptance criteria, read on.

The Nernst equation is a well-established relationship that governs pH:

$$E = E_o + 2.3RT/\eta F * \text{pH}$$

Where

E = millivolts output

E_o = a constant associated with the reference electrode

T = temperature of measurement in Kelvin

R = the universal gas constant

ηF = the Faraday constant

In simplified $y = mx + b$ form, the relationship is (mV output) = (slope) x (pH) + (intercept). Using this form note that the term $2.3RT/\eta F$ is the slope, and it is sometimes called the Nernst potential.

The absolute value of the Nernst potential, at 298 K (25°C), is 59.16 mV/pH unit. At standard temperature, then, when one would change the pH from 7 to 8, the mV change is expected to be -59.16. Extrapolating further, from pH 7 to pH 10, the mV change would be

$$3 * -59.16 = -177.3 \text{ mV/pH unit.}$$

Similarly, from pH 7 to pH 4 the change would be +177.3 mV/pH unit.

Returning to the Nernst equation, note that these slopes are temperature-dependent. During calibration the mV values for two standard buffer solutions are experimentally established and used by the sonde's software to calculate the slope and intercept of the plot of mV vs. pH. Once this calibration has been performed, the mV output of the probe in any sample can be converted by the sonde into a pH value, *as long as the calibration and the reading are carried out at the same temperature.*

In reality the temperature is almost never the same in environmental monitoring as it is during calibration. Thus a mechanism must be in place to compensate for temperature, effectively converting the slope and intercept of the plot of pH vs. mV established at the temperature of calibration into a slope and intercept at the temperature of measurement.

This mechanism is already provided by the Nernst equation. The slope of the plot of pH vs. mV is *directly proportional* to the absolute temperature in degrees Kelvin. Thus, if the slope of the plot is experimentally determined to be 59 mV/pH unit at 298 K (25°C), then the slope of the plot at 313 K (40°C) must be $(313/298) * 59$, or 62 mV/pH unit. At 283 K (10°C), the slope is calculated to be $(283/298) * 59$, which is 56 mV/pH unit. Determination of the slope of pH vs. mV plots at temperatures different from the calibration temperature is thus straightforward.

How can one apply this information for QC?

First, use the temperature compensation to determine what the slope should be for the calibration that was just performed. A calibration performed at 23°C, for instance, should have a slope of $(296/298) \times 59.16$, or 58.76. The calibration worksheet shows "mV per decade" between calibration points, such as from 4 to 7 and 7 to 10.

It is not unusual for the mV per decade to deviate from the ideal predicted by the Nernst equation, but typically it should not deviate more than 4 to 5 mV per decade. In this example, if the mV per decade is 56.51, that would be acceptable to most users. If it were instead 53.43, that could be cause for concern.

Another valuable piece of information on the calibration worksheet is in the "Delta slope," which is the change in mV per decade across the range being measured. As stated above, in an ideal scenario at standard temperature, the "delta slope" going from pH 7 to pH 4 would be +177.3, and going from pH 7 to pH 10 it would be -177.3. If, as in our example here, the calibration was performed at 23°C, and therefore the a slope of 58.75 were calculated, then the delta slope from pH 7 to pH 4 would be $3 \times 58.75 = 176.25$, and the delta slope from pH 7 to pH 10 would be -176.25.

In general it is advisable that the delta slope should not deviate more than about 12-15 from the ideal. So a delta slope for pH 7 to pH 4 of 161 would be considered unacceptable to most users in the present example.

In practice, people don't usually do these calculations, but rather apply a rule of thumb that states, for a laboratory-based calibration where temperature is often near 25°C, the delta slope should always be ≥ 165 .

With a better understanding of the Nernst equation, however, users can monitor the changes in the mV per decade and delta slope, and look for big changes from prior calibration worksheets. These changes, even when the SmartQC Score is green, can be useful indicators of changes in the performance of the pH module with age.

4.20 ORP Calibration

Review the basic calibration description in [Section 4.2](#).

Pour the correct amount of standard with a known oxidation reduction potential value (we recommend Zobell solution) in a clean and dry or pre-rinsed calibration cup. Carefully immerse the probe end of the sonde into the solution.

In the Calibrate menu, select pH/ORP, then select ORP to Calibrate.

Observe the Pre Calibration Value readings and the Data Stability, and when they are Stable, click Apply to accept this calibration point.

NOTICE: Do not leave sensors in Zobell solution for a long time. A chemical reaction occurs with the copper on the sonde (sonde bulkhead, central wiper assembly, copper tape). While the reaction does not impact calibration, it will degrade the sonde materials over time. Discard the used standard.

Click Complete. View the Calibration Summary screen and QC Score. Click Exit to return to the sensor calibration menu.

Rinse the sonde in tap or purified water and dry the sonde.

Effect of temperature on ORP



The oxidation reduction potential value shows an inverse relationship with temperature. This effect must be accounted for when calibrating the EXO ORP sensor with an ORP standard. YSI recommends using Zobell solution for calibration, but other standards may be used. Refer to the table included with your ORP standard instructions for the mV value that corresponds to the temperature of the standard.

SmartQC for ORP Sensors

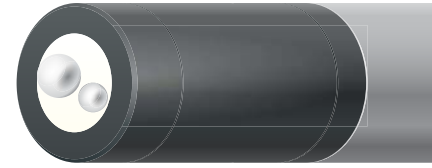
The SmartQC Score for ORP is based on an offset from 0 mV.



Guidance on interpretation of the SmartQC Score for this sensor is as follows:

-  **Green:** Offset is within acceptable limits. Calibration was performed successfully and results are within factory specified limits.
-  **Yellow:** The sensor offset is near the threshold of factory specified limits. If a user calibration results in a yellow QC Score, perform the following actions:
 1. Perform a Factory Reset Calibration. Complete a recalibration using freshly-prepared Zobell solution. Incorrect mixing of the Zobell solution can cause errors in calibration.
 2. The electrolyte solution in the sensor may be partially depleted causing shifts to the millivolt readings. This is not a user-addressable problem, but to prevent it make sure that sensor modules are stored in the same bottle of solution that was shipped with the new modules. Avoid storage of sensor modules in distilled or deionized water.
 3. ORP calibration is temperature-dependent so make sure that the correct standard value was entered, using the instructions that came with the Zobell solution.
 4. Ensure that the sensor is free of debris. Refer to [Section 5.12](#) for information on proper sensor cleaning in order to avoid damaging the sensor.

If the QC Score returns to yellow, the sensor is still able to be used, but the user should monitor this sensor during calibrations for any further drift. Consideration should be made to eventually replacing the pH/ORP sensor module.

-  **Red:** The sensor offset is outside of factory specified limits. If a user calibration results in a red QC Score, follow the same steps described above for a yellow QC Score.

If the QC Score remains red after the Factory Reset Calibration and recalibration, or after replacement of the module and performing a calibration, please contact YSI Technical Support for further assistance.

4.21 Rhodamine Sensor Overview

Rhodamine WT is a fluorescent dye commonly used for time of travel and tracer studies, which provide insight into the hydrological behavior of water bodies. The Rhodamine sensor is a dual-channel fluorescence sensor, featuring a low range channel and a high range channel. This innovative design allows the sensor to detect very low concentrations of Rhodamine WT while maintaining a wide measurement range.

(continued)

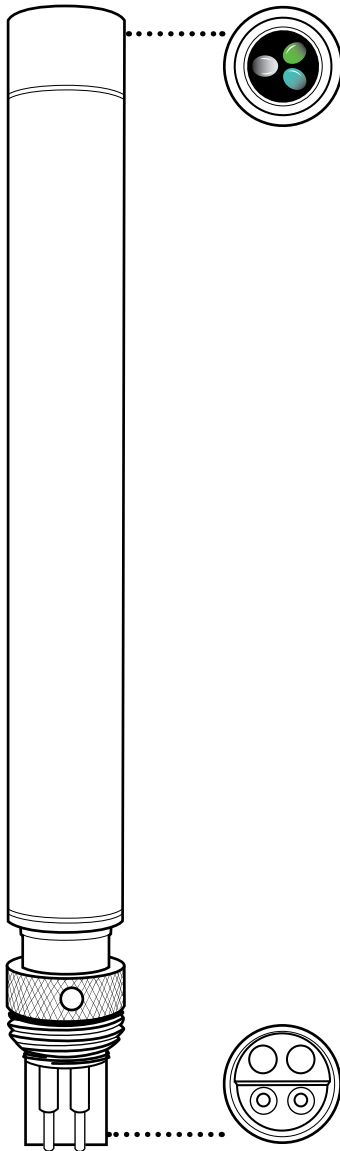

577641

Specifications

Units	RFU, $\mu\text{g/L}$
Temperature	
<i>Operating</i>	-5 to +50°C
<i>Storage</i>	-20 to +80°C
Range	0 to 100 RFU 0 to 1,000 $\mu\text{g/L}$
Accuracy	$\pm 5\%$ or 0.1 $\mu\text{g/L}$ w.i.g
Response	T63 < 2 sec
Resolution	0.01 RFU 0.01 $\mu\text{g/L}$
Linearity	$r^2 > 0.999$
Sensor Type	Optical, fluorescence

4.22 Rhodamine Calibration

For best performance assure that the sensor face is clean prior to calibration. We advise that new sensors should be calibrated before use, and calibration checks and the user's own tolerance of drift should be used to determine when recalibration is necessary.

YSI does not offer Rhodamine WT standards. Users will prepare their own calibration standards by diluting a 2.5% solution of Rhodamine WT. YSI recommends using Bright Dyes Fluorescent FWT Red 25 - Liquid (item # 106023) from Kingscote Chemicals.

The accuracy of the sensor will be directly influenced by the accuracy of the standard solutions used to calibrate the sensor. Preparation of the following solutions requires precise measurement equipment including graduated pipets and volumetric flasks.

A 4-point calibration procedure is necessary to ensure proper performance over the entire 0-1,000 µg/L range of the sensor. The sensor is calibrated to values in µg/L. The sensor can also report in units ppb and RFU.

An EXO Conductivity/Temperature sensor must be installed. The effect of temperature on the Rhodamine sensor electronics and the fluorescence of Rhodamine WT can be significant; however, the combination of these two factors is automatically taken into account by the sensor firmware providing temperature compensated readings. This means the "Standard Values" entered during the calibration procedure should match the concentration of the solutions prepared regardless of temperature variance.

Preparation of Rhodamine WT Dye Solutions

Purchase Rhodamine WT as a 2.5% solution to follow the procedure below. Note that there are many types of Rhodamine—make sure Rhodamine WT is selected. If a 2.5% solution cannot be obtained commercially, prepare it from a liquid solution to a 2.5% final concentration, or adjust the dilutions below accordingly. Kingscote Chemicals (Miamisburg, OH, 1-800-394-0678) has historically offered a 2.5% solution (item #106023) that works well with this procedure. It should be stored in the refrigerator when not in use.

NOTE: Preparation of the following solutions requires precise measurement equipment including graduated pipets and volumetric flasks.

STEP 1: Prepare a 125 mg/L stock solution* of Rhodamine WT.

Transfer 5.0 mL of the 2.5% Rhodamine WT solution into a 1000 mL volumetric flask. Fill the flask to the volumetric mark with deionized or distilled water and mix well to produce a solution that is approximately 125 mg/L of Rhodamine WT. Transfer to a storage bottle and retain it for future use.

*This solution can be stored in the refrigerator (4°C). Its degradation will depend upon light exposure and repeated warming cycles, but solutions used 1-2 times a year can be stored for up to two years. Users should implement their own procedures to safeguard against degradation.

Two concentrations of Rhodamine WT must be prepared from this stock solution:

1. a 25 µg/L standard
2. a standard equal or greater than 125 µg/L, but no more than 1,000 µg/L

STEP 2: Prepare a 25 µg/L standard solution* of Rhodamine WT.

Depending on the amount (volume) of calibration solution you want to produce, use the following instructions:

For 1,000 mL of 25 µg/L solution:

Transfer 0.2 mL or 200 µL of the 125 mg/L Rhodamine WT base solution into a 1,000 mL volumetric flask. Fill the flask to the 1,000 mL volumetric mark with deionized or distilled water and mix well to produce a standard solution that is 25 µg/L of Rhodamine WT.

For 500 mL of 25 µg/L solution:

Transfer 0.1 mL or 100 µL of the 125 mg/L Rhodamine WT base solution into a 500 mL volumetric flask. Fill the flask to the 500 mL volumetric mark with deionized or distilled water and mix well to produce a standard solution that is 25 µg/L of Rhodamine WT.

*This solution can be stored in the refrigerator (4°C). Its degradation is much more rapid than the base solution and should be used or discarded within 30 days.

STEP 3:

NOTE: The second calibration standard solution* must be at least 125 µg/L, but no more than 1,000 µg/L.

Kor Software will not allow for calibration point #4 outside of the 125-1,000 µg/L range. YSI recommends preparing a calibration solution closest to the expected measurement range within these limits.

Refer to the table below to determine the amount of 125 mg/L Rhodamine WT base solution to transfer to a volumetric flask. The columns represent the desired concentration of the standard solution, while the rows represent the desired amount (volume) of standard solution that users would like to produce.

		Concentration			
		125 µg/L	250 µg/L	500 µg/L	1000 µg/L
Volume	500 mL	0.5 mL	1.0 mL	2.0 mL	4.0 mL
	1000 mL	1.0 mL	2.0 mL	4.0 mL	8.0 mL

Table: Amount (mL) of 125 mg/L Rhodamine WT base solution for mixing standard solution.

- Concentration: Users are encouraged to choose a concentration that is closest to the values they expect to measure.
- Volume: Users should select a volume appropriate for the amount of calibrations to be performed.
 - o For multiple sensor calibrations, a larger volume (1,000 mL) may be preferred.
 - o For a single calibration, a smaller volume (500 mL) may be preferred.

Transfer the appropriate amount of 125 mg/L Rhodamine WT base solution into the preferred volumetric flask based on the standard solution concentration desired. Fill the flask to the volumetric mark with deionized or distilled water and mix well to produce the standard solution.

*This solution can be stored in the refrigerator (4°C). Its degradation is much more rapid than the base solution and should be used or discarded with 30 days.

Calibration of Rhodamine Sensor

Rhodamine is a dual channel sensor that requires a 4-point calibration; 2 points for each channel. Calibration point #1 is simply a zero solution (typically DI water). Calibration points #2 and #3 are identical, using the same 25 µg/L Rhodamine WT solution. Calibration point #4 can be any concentration equal to or greater than 125 µg/L, but no more than 1,000 µg/L. For best practices, rinse and dry between standard solutions.

NOTE: *Before proceeding with the calibration*

- make sure all sensors, guards, and calibration cups are clean
- make sure an EXO Conductivity/Temperature sensor is installed

STEP 1: Calibration Point #1 at 0 µg/L.

Place the sonde into a clean calibration cup containing distilled or deionized water. The software or handheld will show a graph while the sensor is stabilizing. Make sure the "Standard Value" is equal to zero (0). When the Data Stability indicates "Stable", click "Apply" in the software or "Accept Calibration" on the handheld. In the software, select "Add Another Cal Point" and proceed to Step 2.

STEP 2: Calibration Point #2 at 25 µg/L.

Place the sonde into a clean calibration cup containing the prepared 25 µg/L standard. Make sure the "Standard Value" is equal to 25. When the Data Stability indicates "Stable", click "Apply" in the software or "Accept Calibration" on the handheld. In the software, select "Add Another Cal Point" and proceed to Step 3.

NOTE: *Keep the sensors submerged in the 25 µg/L standard solution as you proceed to calibration point #3.*

STEP 3: Calibration Point #3 at 25 µg/L.

With the sensors still in the 25 µg/L standard solution, make sure the "Standard Value" is still equal to 25. When the Data Stability indicates "Stable", click "Apply" in the software or "Accept Calibration" on the handheld. In the software, select "Add Another Cal Point" and proceed to Step 4.

STEP 4: Calibration Point #4 at user preferred concentration (125-1,000 µg/L).

Place the sonde into a clean calibration cup containing the prepared µg/L standard solution. Make sure the "Standard Value" is equal to the concentration prepared. When the Data Stability indicates "Stable", click "Apply" in the software or "Accept Calibration" on the handheld. Finally, select "Complete Calibration" [software] or "Finish Calibration" [handheld] and proceed to the calibration review screen. From here users can view the Calibration Report or select "Exit" to return to the main calibration menu.

Note that throughout this process users have the option to "Redo" a calibration point without having to exit and start the process over.

SmartQC for Rhodamine Sensors

The SmartQC Score for Rhodamine is based on gain factor and an offset factor. Both of these values may change as the sensor and the optics age.

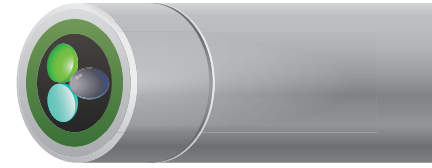

Guidance on interpretation of the SmartQC Score for this sensor is as follows:

 **Green:** Gain and offset are within acceptable limits. Calibration was performed successfully and results are within factory specified limits.

 **Yellow:** The sensor gain or offset is slightly outside of calibration limits. If a user calibration results in a yellow QC Score, perform the following actions:

1. Perform a Factory Reset Calibration and complete a recalibration.
2. Ensure that the standard value was entered correctly. Calibration points #2 and #3 must be set at 25 µg/L. Calibration point #4 must be set at a minimum of 125 µg/L, but no greater than 1,000 µg/L.
3. Ensure that the sensor is free of contamination. Refer to [Section 5.6](#) for additional information on how to properly clean the sensor in order to avoid damage.

If the QC Score returns to yellow, the sensor is still able to be used, but the user should monitor this sensor during calibrations for any further drift.

 **Red:** The sensor gain or offset are significantly outside of factory specified limits. If a user calibration results in a red QC Score, follow the same steps described above for a yellow QC Score.

If the QC Score remains red, please contact YSI Technical Support for further assistance.

4.23

Total Algae Sensor Overview

The Total Algae (TAL) sensors are dual-channel fluorescence sensors. The “channels” are for chlorophyll and phycocyanin (TAL-PC), or chlorophyll and phycoerythrin (TAL-PE), which are measured in the water. Each sensor thus yields two data sets: for TAL-PC, one results from a blue-emitting LED that excites the chlorophyll a (chl) molecule and the second results from an orange excitation beam that excites the phycocyanin (PC) accessory pigment. The TAL-PE sensor is similar, also having the chlorophyll channel, but rather than an orange-emitting LED there is a slightly blue-shifted beam that excites phycoerythrin (PE).

(continued)

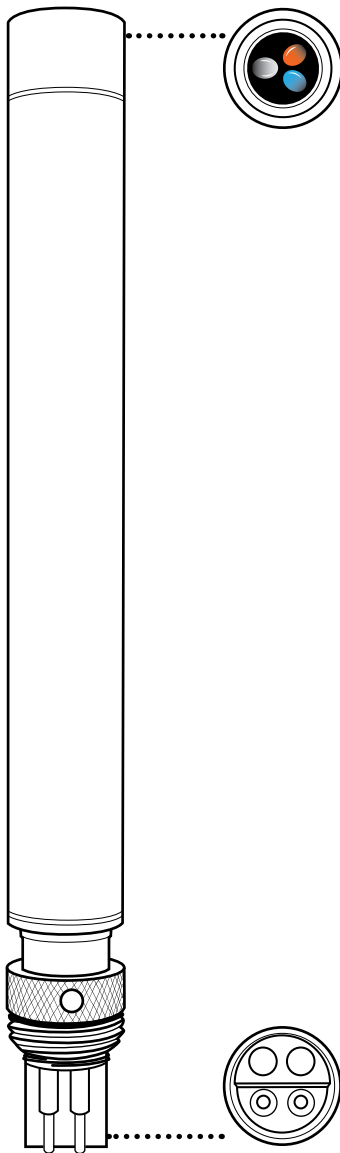

599102-01 (TAL-PC)

599103-01 (TAL-PE)

Specifications

Units	
<i>Chlorophyll</i>	RFU, µg/L Chl
<i>PC</i>	RFU, µg/L PC
<i>PE</i>	RFU, µg/L PE
Temperature	
<i>Operating</i>	-5 to +50°C
<i>Storage</i>	-20 to +80°C
Range	<i>Chl</i> : 0-100 RFU, 0-400 µg/L Chl*; <i>PC</i> : 0-100 RFU, 0-100 µg/L*; <i>PE</i> : 0-100 RFU, 0-280 µg/L*
Response	T63<2 sec
Resolution	<i>Chl</i> : 0.01 RFU, 0.01 µg/L Chl; <i>PC</i> : 0.01 RFU, 0.01 µg/L; <i>PE</i> : 0.01 RFU, 0.01 µg/L
Sensor Type	Optical, fluorescence
Linearity	<i>Chl</i> : R ² >0.999 for serial dilution of Rhodamine WT solution from 0-400 µg/L Chl equivalents <i>PC</i> : R ² >0.999 for serial dilution of Rhodamine WT solution from 0-100 µg/L PC equivalents; <i>PE</i> : R ² >0.999 for serial dilution of Rhodamine WT solution from 0-280 µg/L PE equivalents
Optics:	
<i>Chl Excitation</i>	470±15 nm
<i>PC Excitation</i>	590±15 nm
<i>PE Excitation</i>	525±15 nm
Emission	685±20 nm

*Pigment concentration ranges of algae sensors were determined in monocultures of specific algae species. This range will vary depending on algae assemblage and environmental conditions. The best accuracy of pigment measurements can be obtained by user-built correlations between RFU and pigment concentrations measured by an independent method, and using samples from the site or sites of interest with representative algal populations.

Total Algae Sensor Units

The TAL sensors generate data in RFU or $\mu\text{g/L}$ of pigment (chl, PC or PE) units, with RFU as the default. When using either RFU or $\mu\text{g/L}$, the sensor's response is highly linear: a reading of 50 of either unit represents twice as much fluorescence detected as a reading of 25, for example, if the temperature is constant.

However, users are advised to use default RFU, which stands for Relative Fluorescence Units. RFU is used to set sensor output relative to a stable secondary standard, rhodamine WT dye, which normalizes the sensor's output on a 0-100% scale. RFU calibration allows for the best comparisons of data from sensor to sensor, and also enables users to monitor for sensor drift and edaphic factors such as biofouling or declining sensor optical performance over time as the LEDs age. Another reason to use RFU is the excellent linearity once the channels are calibrated with Rhodamine WT, which translates to optimized accuracy of measurements.

The $\mu\text{g/L}$ output generates an estimate of pigment concentration that is based upon correlations we built between sensor outputs and extracted pigments from laboratory-grown blue-green algae. Synonymous with parts per billion (ppb), $\mu\text{g/L}$ is still in common use by regulatory agencies, but has the drawback that it is very dependent upon the composition of the algal population, the time of day, the physiological health of the algae, and a number of other environmental factors. So if two populations of algae yield a reading of 50 $\mu\text{g/L}$ of chlorophyll, it does not mean that those populations are equivalent in the number of cells, for instance. Further, since algal populations can regulate their intracellular pigment concentrations, the $\mu\text{g/L}$ of pigment per cell changes with season, time of day, and population dynamics. Thus the challenge with the $\mu\text{g/L}$ unit is user expectations: it should not be expected that $\mu\text{g/L}$ will necessarily correlate well with pigment extractions that customers perform themselves, and it should not be expected that a doubling of $\mu\text{g/L}$ necessarily represents a doubling of the algal population.

RFU is likewise affected by these dynamics: a doubling of RFU does not necessarily mean there has been an exact doubling of an algal population. But it is generally more clear to users that an RFU is detecting a change in relative fluorescence signal, which can occur for a number of reasons in situ.

In any case, many users are required for regulatory compliance to deliver data in $\mu\text{g/L}$, and in waters where the algal populations are fairly predictable or stable from year to year, with respect to species compositions, good correlations can be built. So users are advised to assess whether the pigment concentration delivered by the sensor is reasonable and acceptable for the algal populations and environment with which they work.

That assessment should start with calibration of both RFU and $\mu\text{g/L}$ channels with rhodamine WT, as described in the next section. Next, with samples collected from the site of interest, measure both RFU and $\mu\text{g/L}$ with the sensor(s). Observing careful handling and preservation of the samples, as soon as possible extract the pigments from the samples, using standardized or preferred methods to determine pigment $\mu\text{g/L}$ in each sample. The extraction data may be used to assess how RFU and $\mu\text{g/L}$ delivered by the sensor compare with the extracted $\mu\text{g/L}$ of pigment that would be predicted by the sensor. Ideally this would be done with a dilution series of the original sample or at the very least multiple samples. The user's requirements for how well $\mu\text{g/L}$ delivered by the sonde must correlate with their own extraction data will determine whether the $\mu\text{g/L}$ output should be used for reporting.

Measuring cells/mL with EXO TAL Sensors

Similar to $\mu\text{g/L}$, some users have a requirement to report cell/mL data for blue-green alga monitoring, even though in reality these measurements vary widely from algal population to algal population in situ. Within KorEXO 2.0 and later software versions, there is the capability to have the sonde deliver this unit for the PC and PE channels, based upon user-applied correlations.

When selecting the TAL sensor in the Calibration module of the software, there is a "TAL-PC Phycocyanin Settings" window (or TAL-PE if that is the sensor in use). There are two radio buttons that appear when that window is opened:

- Use legacy cells/mL relationship
- Build my own cells/mL relationship

The first option was designed for users that were accustomed to this unit in our legacy 6-Series sondes, and who want their EXO data to tightly match the cells/mL data generated by these older sondes. The algorithm applied to "match" these outputs across sonde platforms is proprietary, and it is highly advisable that when using this unit at some point users actually test the validity of the outputs for their applications. This can be done by collecting grab samples and comparing actual cells/mL using microscopy or plating as appropriate.

A better method would be to use the second option of building one's own cells/mL relationship. This makes a module appear wherein users can enter an RFU measurement alongside a corresponding cells/mL measurement that has been made for the exact same sample, using microscopy or whatever method the user prefers. The software will derive the relationship between the columns entered by the user and will apply that equation to all subsequent measurements to deliver the cells/mL unit in the sonde's output.

From time to time and place to place, the validity of this correlation can be tested, verified, or validated by collecting grab samples and comparing in vitro measurements of cells/mL with the in situ values delivered by the sonde.

In all cases, proper calibration of the sensor with Rhodamine WT is necessary for the most reliable outputs, and for comparison of data from sensor to sensor.

4.24 Total Algae Calibration

For best performance assure that the sensor face is clean prior to calibration. We advise that new sensors should be calibrated before use, and calibration checks and the user’s own tolerance of drift should be used to determine when recalibration is necessary.

Users will prepare their own calibration standards. Rhodamine WT is a secondary standard (the actual pigments would be primary standards). It is used because of its stability and affordability. The units that the sensor delivers are in either RFU (recommended) or µg/L pigment equivalent units. We strongly recommend using RFU, but in either case Table A below must be used to derive the calibration values that the user will enter during the process outlined below. Use of this table requires a temperature measurement, and the best way to do this is to have an EXO conductivity/temperature sensor on the sonde bulkhead during calibration. In general fluorescence is inversely related with temperature, and this effect will be accounted for to optimize the accuracy of your calibration by using the following table.

Solution Temperature (°C)	Chlorophyll 0.625 mg/L Rhodamine		Phycocyanin 0.625 mg/L Rhodamine		Phycoerythrin 0.025 mg/L Rhodamine	
	Chl RFU	µg/L chlorophyll	PC RFU	µg/L phycocyanin	PE RFU	µg/L phycoerythrin
30	14.0	56.5	11.4	11.4	37.3	104.0
28	14.6	58.7	13.1	13.1	39.1	109.0
26	15.2	61.3	14.1	14.1	41.0	115.0
24	15.8	63.5	15.0	15.0	43.0	120.0
22	16.4	66	16.0	16.0	45.0	126.0
20	17.0	68.4	17.1	17.1	47.0	132.0
18	17.6	70.8	17.5	17.5	49.2	138.0
16	18.3	73.5	19.1	19.1	51.4	144.0
14	18.9	76	20.1	20.1	53.6	150.0
12	19.5	78.6	21.2	21.2	55.9	157.0
10	20.2	81.2	22.2	22.2	58.2	163.0
8	20.8	83.8	22.6	22.6	60.6	170.0

Table: Temperature-compensated standard solution values for TAL sensors.

Steps 1-3 below describe a standard two point calibration performed with Kor EXO 2.0 software. Calibration can also be performed using the EXO Handheld, the main differences simply being the references to windows. In some cases users may prefer to perform a re-zeroing of the sensor, sometimes referred to as a “one point calibration,” and that is described later in this section.

Step 1: Prepare Rhodamine WT Dye Solution

Purchase Rhodamine WT as a 2.5% solution to follow the procedure below. Note that there are many types of Rhodamine—make sure Rhodamine WT is selected. If a 2.5% solution cannot be obtained commercially, prepare it from a solid or liquid solution to a 2.5% final concentration, or adjust the dilutions below accordingly. Kingscote Chemicals (Miamisburg, OH, 1-800-394-0678) has historically had a 2.5% solution (item #106023) that works well with this procedure. It should be stored in the refrigerator when not in use.

NOTE: Preparation of the following solutions requires precise measurement equipment including graduated pipets and volumetric flasks.

1. For any TAL sensor calibration, prepare a 125 mg/L solution of Rhodamine WT. Transfer 5.0 mL of the 2.5% Rhodamine WT solution into a 1000 mL volumetric flask. Fill the flask to the volumetric mark with deionized or distilled water and mix well to produce a solution that is approximately 125 mg/L of Rhodamine WT. Transfer to a storage bottle and retain it for future use.

*This solution can be stored in the refrigerator (4°C). Its degradation will depend upon light exposure and repeated warming cycles, but solutions used 1-2 times a year can be stored for up to two years. Users should implement their own procedures to safeguard against degradation.

2. For calibration of any chlorophyll channel (on either the TAL-PC or the TAL-PE sensor) and the TAL-PC phycocyanin channel, prepare a 0.625 mg/L solution of Rhodamine WT. Transfer 5.0 mL of the 125 mg/L solution prepared in step one into a 1000 mL volumetric flask. Fill the flask to the volumetric mark with deionized or distilled water. Mix well to obtain a solution that is 0.625 mg/L of Rhodamine WT. Use this solution within 24 hours of preparation and discard it after use.

3. If using a TAL-PE sensor, additionally prepare a 0.025 mg/L solution of Rhodamine WT for calibration of the phycoerythrin channel. Transfer 0.2 mL of the 125 mg/L solution prepared in step one into a 1000 mL volumetric flask. Fill the flask to the volumetric mark with deionized or distilled water. Mix well to obtain a solution that is 0.025 mg/L of Rhodamine WT. Use this solution within 24 hours of preparation and discard it after use.

Step 2: Select the pigment and channel to be calibrated.

In the Kor software or on the handheld, select the channel you want to calibrate (chl, PC, or PE) and the units you intend to use (RFU or $\mu\text{g/L}$).

Note that each channel of the sensor must be calibrated independently. Calibration of the chlorophyll channel does not set the calibration for the PC channel or the PE channel. Likewise, even just for the chlorophyll channel, calibration of RFU does not automatically calibrate the $\mu\text{g/L}$ units. Calibration must be performed for each channel of interest, each unit of interest, and each calibration point (zero and the second point). It is thus possible that Step 3 below will be performed up to 8 times total, if one wants reading for all units from all channels. This is cut in half if only RFU are used, which is YSI's recommendation.

Step 3: Perform a two-point calibration.

Step 3a: Calibration at zero.

The zero point is always calibrated first. Place the sonde, loaded with a TAL and an EXO temperature sensor, into a clean calibration cup containing clean water. It is not required that this be deionized or even distilled water; it must be free of any particles that might fluoresce and interfere with the calibration process. Thus distilled water is typically what users prefer to have that assurance.

The software or handheld will show a graph while the sensor is stabilizing, and the temperature will also be shown. Temperature is not needed for the zero point; the user must enter a "Standard Value" of 0. When the Data Stability indicates "Stable", click to "Apply" the calibration. Next select "Add Another Cal Point" and proceed to Step 3b.

Step 3b: Calibration with Rhodamine WT

The same basic procedure will be followed, but using either Kor software or the EXO handheld will require that users enter the temperature-compensated standard value for the calibration solution. In all cases, the reading from the EXO temperature sensor is the most reliable to use, and the value for the standard can be derived from the Table A provided above.

As an example, assume that you will calibrate the chlorophyll RFU channel, and that the temperature measured in the 0.625 mg/L rhodamine WT solution is 22°C. This temperature will show up on the calibration screens using the KorEXO software, and can be seen on the handheld's dashboard screen as well. The first standard value entered during calibration will be 0, since that standard will be water (see Step 3 below). The second standard value will be 16.4, as derived from Table A using a temperature of 22°C. Alternatively, if you intend to use the µg/L unit, the second standard value would be 66 for this example. Using the same 0.625 mg/L rhodamine WT solution to calibrate the PC channel will yield a second standard value of 16.0 RFU or 16 µg/L. You will enter these values when you perform the calibration.

Upon entering the Table A-derived value, wait for the sensor to show "Stable" and then click on "Apply". Now choose "Complete Calibration" and then "Exit."

Note that throughout this process users had options to "Redo a cal point" or to "View Calibration Worksheet." So for any channel and a given unit of interest, a point can be redone at any time without having to exit out to the beginning of the process.

However, to now calibrate other units for either the same or different pigment channels, this process must be started again at Step 2.

Re-zeroing the TAL Sensor.

Oftentimes users will perform a “cal check” in water to assess if the sensor has drifted beyond an acceptable limit defined by that user. When drift has occurred ideally a two-point calibration should be performed. However, when there isn’t an opportunity to prepare the rhodamine solutions and perform a two-point calibration, or if users are mainly interested in accuracy at the lower end of the sensor’s range, they may choose to re-zero the sensor.

Historically referred to as a “single-point calibration,” doing a calibration with water only resets the zero value, called here “re-zeroing” the sensor. The main advantage of doing this is speed, and users should be aware that re-zeroing the sensor does not reset the second point entered during the most recent two-point calibration. The consequence is that drift error will be alleviated at and near zero, but more error can accumulate in the measurement the farther away from zero the measured value is. The amount of that error can be different from sensor to sensor, and use case to use case. It is dependent upon how much that second point may drift, which is not always equivalent to how much the zero point drifts.



For many users, especially those with sites where pigment is rarely detected and values are at or near zero most of the time, the far-from-zero accumulation of error is a non-issue. For others, a single point calibration may not be acceptable. A single-point calibration is an option in the software and is performed exactly the same way as the two- point calibration, using water as the standard and waiting for the value to stabilize before applying it. Rather than adding a second calibration point, the user would exit after the water calibration.

SmartQC for TAL Sensors

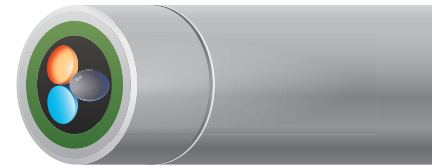
The SmartQC Score for any TAL sensor is based on an offset from 0 RFU, and a gain factor. Each individual channel (Chl, PC, PE) has a unique offset and gain factor. Each individual channel (Chlorophyll, Phycocyanin, Phycoerythrin) has a unique offset and gain factor. It is possible to have a green SmartQC Score for calibration of one channel, but a yellow or red SmartQC Score for the second channel. In this case the TAL sensor SoftQC that is shown in Kor Software will appear as the worst QC Score (yellow or red), and one must look at the individual channels to investigate where the issue is. Thus the steps outlined here are for each channel, and for each unit calibrated within that channel.



Guidance on interpretation of the SmartQC Score for this sensor is as follows:

-  **Green:** Gain and offset are within acceptable limits. Calibration was performed successfully and results are within factory specified limits.
-  **Yellow:** The sensor gain or offset is near the threshold of calibration limits. If a user calibration results in a yellow QC Score, perform the following actions:
 1. Perform a Factory Reset Calibration and complete a recalibration.
 - a. If performing a 1-point calibration, use fresh, clear water.
 - b. If performing a 2-point calibration, use fresh, clear water and freshly made Rhodamine WT solution.
 2. Ensure that the standard value was entered correctly. Calibration of TAL channels is temperature-dependent; make sure the appropriate value from the table in [Section 4.22](#) was entered during calibration for either RFU or $\mu\text{g/L}$.
 3. Ensure that the sensor is free of debris. Refer to [Section 5.6](#) for additional information on how to properly clean the sensor in order to avoid damage.

If the QC Score returns to yellow, the sensor is still able to be used, but the user should monitor this sensor during calibrations for any further drift.

-  **Red:** The sensor gain or offset are outside of factory specified limits. If a user calibration results in a red QC Score, follow the same steps described above for a yellow QC Score.

If the QC Score remains red, please contact YSI Technical Support for further assistance.

4.25 Turbidity

Sensor Overview

Turbidity is the indirect measurement of the suspended solid concentration in water and is typically determined by shining a light beam into the sample solution and then measuring the light that is scattered off of the suspended particles. Turbidity is an important water quality parameter and is a fundamental tool for monitoring environmental changes due to events like weather-induced runoff or illicit discharges. The source of the suspended solids varies (examples include silt, clay, sand, algae, and organic matter) but all particles will impact light transmittance and result in a turbidity signal.

(continued)

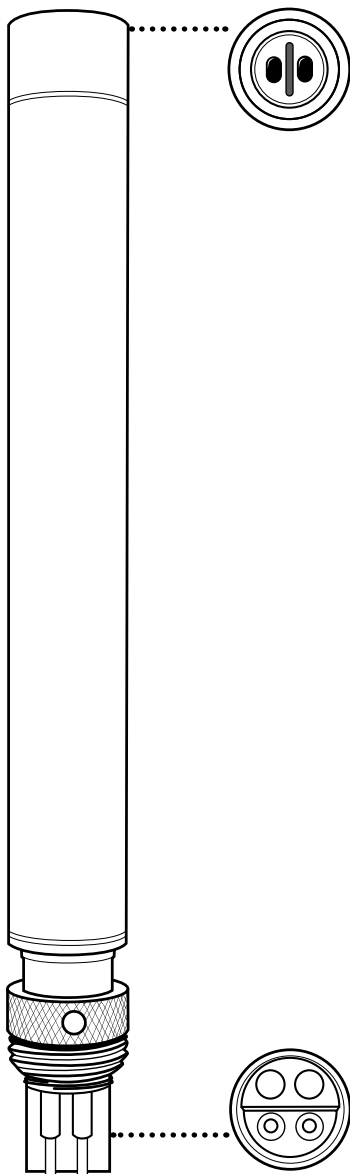

Specifications

Default Units	FNU
Temperature	
Operating	-5 to +50°C
Storage	-20 to +80°C
Range	0 to 4000 FNU
Accuracy	0-999 FNU: 0.3 FNU or ±2% of reading, whichever is greater; 1000-4000 FNU: ±5% of reading ²
Response	T63<2 sec
Resolution	0-999 FNU: 0.01 FNU 1000-4000 FNU: 0.1 FNU
Sensor Type	Optical, 90° scatter
Optics:	
Excitation	860±15 nm

¹ ASTM D7315-07a "Test Method for Determination of Turbidity Above 1 Turbidity Unit (TU) in Static Mode."

² Performance based on 3-point calibration done with YSI AMCO-AEPA standards of 0, 124, and 1010 FNU. The same type of standard must be used for all calibration points.

599101-01

The EXO Turbidity sensor employs a near-infrared light source and has been characterized as a nephelometric near-IR, non-ratiometric sensor in accordance with ASTM Method D7315-07a.¹ This method calls for this sensor type to report values in formazin nephelometric units (FNU), which is the default calibration unit for the EXO sensor. Users are able to change calibration units to nephelometric turbidity units (NTU).

Turbidity is one of the most misunderstood measurements in environmental monitoring. In reality the turbidity sensor is not much different from other optical sensors: differences in outcomes with different standards, sensors and environments can be a result of differing optical components and geometries, and the impact of different environmental factors upon the measurement technologies themselves. Thus like many optical measurements, where a light beam is passing through a sample in an environment of changing temperature, etc., turbidity is best monitored with consistent use of standards, technology platforms, and practices to compare outcomes for scientific conclusions.

Among the many factors that can impact turbidity measurements, users should be aware of three over which they have some control. These are the use of recommended YSI standards, preventing fouling, and using sound and consistent calibration practices.

Turbidity Standards

Turbidity sensors of many types, from many manufacturers, are often calibrated with formazin. Considered the “gold standard” for turbidity calibration there is the perception that all turbidity sensors will read consistently in formazin. In practice this has led to the belief that two different sensors of different types (design or manufacturer, for instance), if calibrated in formazin, would yield the same FNU when used to measure a sample. When sensors are of the same fundamental design, using the same type of light source and with detection of scattering at the same angles of incident light, this is more likely to be true, especially if measuring an actual formazin solution. However, with field samples this rule does not always hold; different manufacturer’s sensors calibrated with the same formazin solutions can yield slightly different readings from the same field samples. There can be a number of reasons for this, including how the raw data are post-processed.

Due to the challenges of preparation and disposal of formazin, polymer-based standards are now preferred as turbidity standards. As with formazin, it is the case that field readings will vary between different models of turbidity sensors even when they are calibrated with the same standards. This is true of the popular AMCO-AEPA standards upon which YSI’s standards solutions are based, and which were used to determine the Specifications shown below.

Further, if YSI sensors are calibrated with the non-YSI standard AMCO-AEPA solutions, sensor specifications may differ from those shown in the Specification table, and thereby turbidity measurements may differ. For the best consistency, EXO users should use the YSI-labeled turbidity standards throughout the lifetime of their sensors, and use the FNU values on the labels of these standards during calibration.

While formazin can be used to calibrate YSI’s EXO turbidity sensors, the specifications were determined with YSI-labeled AMCO-AEPA turbidity standards, and the factory-defined limits for the SmartQC tool were also determined with YSI standards.

Preventing Fouling

Turbidity measurements are vulnerable to both biofouling and non-biological fouling. This is because of the high sensitivity and resolution of measurements, which can be affected by any changes to the sensor face that light must pass through. Any obstruction of that light path will affect measurements, and even bubbles on the sensor's face can affect measurements. Low-range measurements (e.g. <100 FNU) are especially susceptible to these effects.

As such it is imperative in continuous monitoring applications that antifouling tools be employed. The central wiper on the EXO 2, 2^s, and 3 sondes is highly effective in combating fouling during continuous monitoring, and can be aided by strategies like C-spray and copper tape on the sensors. Even during spot-sampling applications such as with EXO 1 it is very important that users pay attention to the sensor faces so that they are not trapping bubbles during measurements.

Calibration Practices

The following section describes in detail how to calibrate EXO turbidity sensors. Before calibrating, be certain that the probe is very clean and free of debris. Solid particles, particularly those carried over from past deployments, will contaminate the standards and can cause either calibration errors and thereby errors in measurement.

The cleaning instructions in [Section 5.6](#) should be helpful for preventing contamination, but another recommendation we make is to have a sonde guard and a calibration cup devoted solely to turbidity calibration.

Finally, never calibrate turbidity *without* the sonde guard. If one is using the copper antifouling guard for a deployment, then that is the guard that should be used during turbidity calibration (don't use the standard black guard).

4.26

Turbidity Calibration

Tools and Practices

YSI Turbidity standards that are based upon AMCO-AEPA polymer are the basis of SmartQC and EXO turbidity sensor specifications, and therefore should be used for turbidity sensor calibration. Gallon bottles are available as follows:

Item No.	Description
608000	0 FNU
607200	12.4 FNU
607300	124 FNU
607400	1010 FNU

Standards should be selected based upon the range in which one is expected to work. For low-turbidity waters, one might use 0 and 12.4 for a two-point calibration. If turbidities might exceed the lower ranges 0 and 124 should be used for a two-point calibration (not 0 and 1010 for reasons described below), and 0, 124 and 1010 for a three-point calibration. There is not a calibration standard beyond 1010 FNU at this time.

The FNU of each bottle can change with production batches, and as such the label of the bottle should always be checked for the FNU that should be entered into the software or handheld during calibration.

In some cases it may be acceptable to use deionized or distilled water rather than YSI's 0 FNU standard. Beware, however, that distilled water from some sources has been shown to not be 0 FNU. Calibration with a non-zero standard can cause negative readings when the sensor is used in waters that actually are clear. Non-zero readings also can occur if the calibration equipment (e.g. sonde guard, calibration cup) is not sufficiently clean.

Some users will have a preference, if not a requirement, for use of formazin standards. Examples may be formazin prepared according to *Standard Methods for the Treatment of Water and Wastewater* (Section 2130 B), or Hach StablCal™ of various NTUs. These standards are acceptable for a two-point calibration. However, users who anticipate working in higher turbidities and who choose to use a formazin standard for the third point may see yellow SmartQC Scores during that calibration. The sensor can still be used, but since the algorithms for calibration were developed with YSI's polymer beads there may be less perfect alignment of the gain factors when using formazin.

Note also that if doing a three-point calibration, one should not use formazin for the second point, and polymer for the third point. Rather, one should only use the polymer for all points of a three point calibration (or water for 0 FNU and polymer for the second and third points), or formazin for all three points.

In all cases, due to the non-linear response of turbidity sensors and YSI's proprietary algorithms for post-processing of the data, the points of a two or three point calibration must be within the limits outlined here:

First Point	> 0 and ≤1 FNU
Second Point	>5 and ≤200 FNU
Third Point	>400 and ≤4200 FNU

The second calibration point, whether one is using formazin or YSI's polymer, should not be out of the 5-200 FNU range. If one tries to use a standard that is in the 400-4200 FNU range for the second calibration point, accuracy cannot be assured and often a yellow QC Score will result.

Performing a 2-point calibration

Pour the 0 FNU standard (or deionized or distilled water) into the clean calibration cup and immerse the probe end of the sonde into the standard. The sonde should have the sonde guard on, and if one will deploy with the copper antifouling guard that is likewise the guard that should be used during calibration. Pay careful attention while submersing the sensors to not trap bubbles on the face of the turbidity sensor(s).

In either KorEXO Software or the handheld's Calibration menu, select Turbidity to calibrate.

Enter 0.0 (or some offset value between 0.0 and 1.0) as the first calibration value. While the sensor is still stabilizing one may wipe the sensors (using the button in the software or menu option on the handheld) to remove any bubbles. When the data are Stable, select the option to "Apply calibration" for this point.

It is advised at this point that the sensors, sonde guard, and calibration cup be rinsed with a small amount of the standard that will be used for the second calibration point. Discard this rinse, and then fill the cup with the second calibration standard. Click Add Another Cal Point in the software.

Place the sensors into the second calibration standard, and follow the same steps to wipe and obtain a stable reading. Use the value on the label of the YSI standard bottle for the FNU of the second calibration point.

When the data are Stable, select the option to "Apply calibration" for this point. Select the option to complete the calibration and observe the SmartQC Score in the calibration worksheet. In KorEXO Software, color indicators will also make the QC Score apparent.

Rinse the sonde with water and discard all used turbidity standards.

Performing a 3-point calibration

The steps for a three-point calibration are the same as describe above, but note that:

- The first point must always be 0 FNU, followed by the second standard (5-200 FNU) and then third (400-4200 FNU).
- Always use the same type of standard for the two non-zero points. Both must be YSI polymer, or both must be formazin.
- It is critically important, between the second and third calibration points, to rinse the sensors, sonde guard, and calibration cup with water, blot them dry with a lint-free material, and then do a rinse (at least once) with the standard for the third calibration point.

SmartQC for Turbidity Sensors

The turbidity response is nonlinear across the sensor's range, and a proprietary algorithm that employs up to five terms is used during calibration and for generation of the SmartQC Score. Three of those terms are the actual calibration points, and those calibration points must read within an absolute range set within the sensor (this is slightly different than the concept of an offset that is used for SmartQC on most sensors). Two of the terms are calculated from the ratios of the calibration points, and likewise must be within an absolute range set within the sensor. The result is that the SmartQC calculation for turbidity is slightly different depending upon whether one does a 1, 2, or 3 point calibration. Since each individual term used by the algorithm must fall within an absolute range SmartQC is most reliable when the YSI standards, upon which these algorithms were built, are used.

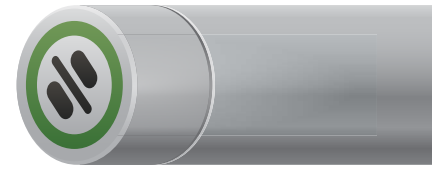

Guidance on interpretation of the SmartQC Score for this sensor is as follows:

 **Green:** A green SmartQC Score means that the point for a single-point calibration is within the specified range. For a two-point calibration a green SmartQC Score means that both calibration points, as well as the slope between them, is within the specified range for each term. For a three-point calibration a Green SmartQC Score means that all three calibration points, as well as the slope between the first two points and the slope between the second two points, are within the specified ranges for each term.

 **Yellow:** A yellow SmartQC Score can result if any one of the five terms of interest is outside of the factory-specified range. If a user calibration results in a yellow QC Score, perform the following actions:

1. Perform a Factory Reset Calibration and re-do the calibration.
2. If a two-point calibration was performed, make sure that the second point is between 5-200 FNU.
3. If a three point calibration was performed with formazin, make sure that each calibration point was within the specified ranges of 0-1 FNU, 5-200 FNU, and 400-4200 FNU.
4. If a three point calibration was performed with YSI's polymer standards, make sure the correct values from the bottles were entered during calibration. For example, make sure the EXO values, and not the 6-Series values, were entered from the label.
5. Make sure you are using YSI's polymer standards. Difficulties in calibration may occur if AMCO-AEPA standards that were not produced for YSI instruments are used. These will not have a YSI label on them.
6. It is imperative that the sensors, calibration cup, and sonde guard are all very clean when calibrating turbidity.
7. Customers who use the 12.4 NTU standard to calibrate will often see a yellow QC Score, even with a perfect calibration.
8. Always use an EXO calibration cup and EXO probe guard with bottom plate during the turbidity calibration.

 **Red:** Any of the five terms of interest may be outside of the factory-set specifications. If a user calibration results in a red QC Score, follow the same steps described above for a yellow QC Score.

If the QC Score remains red, please contact YSI Technical Support for further assistance.

4.27

Total Suspended Solids Calculation

Please follow the process below to calculate TSS.

NOTE: This process cannot be performed via the EXO handheld. It must be done using KorEXO Software.

Turbidity Sensor



Bulkhead Port Number : 4
Serial Number : 18H105991
Firmware Version : 3.0.0

Step 1

Make sure the turbidity probe is installed in the sonde.

Step 2

In KorEXO Software, connect to the sonde, and navigate to Instruments and Sensors>Turbidity. The correlation table appears under the Turbidity Settings header.

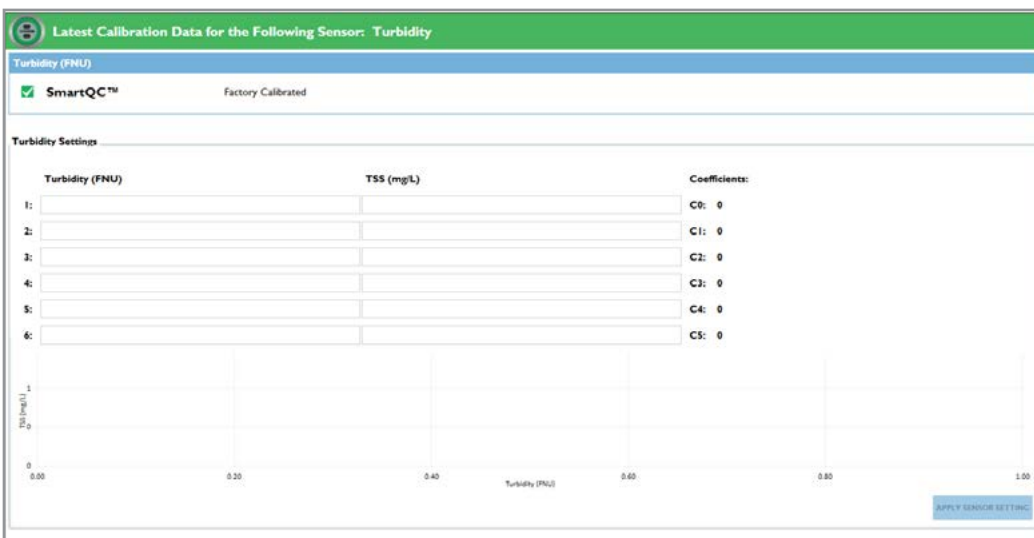

Latest Calibration Data for the Following Sensor: Turbidity

Turbidity (FNU) SmartQC™ Factory Calibrated

Turbidity Settings

Turbidity (FNU)	TSS (mg/L)	Coefficients:
1: <input type="text"/>	<input type="text"/>	C0: 0
2: <input type="text"/>	<input type="text"/>	C1: 0
3: <input type="text"/>	<input type="text"/>	C2: 0
4: <input type="text"/>	<input type="text"/>	C3: 0
5: <input type="text"/>	<input type="text"/>	C4: 0
6: <input type="text"/>	<input type="text"/>	C5: 0

Graph: Y-axis is TSS (mg/L), X-axis is Turbidity (FNU). An 'APPLY SENSOR SETTING' button is at the bottom right.

Step 3

Type in the turbidity NTU/FNU values and the corresponding TSS values obtained through lab analysis into the table. The coefficients will automatically calculate and a graph will be generated as additional values are added. Click Apply Sensor Setting.

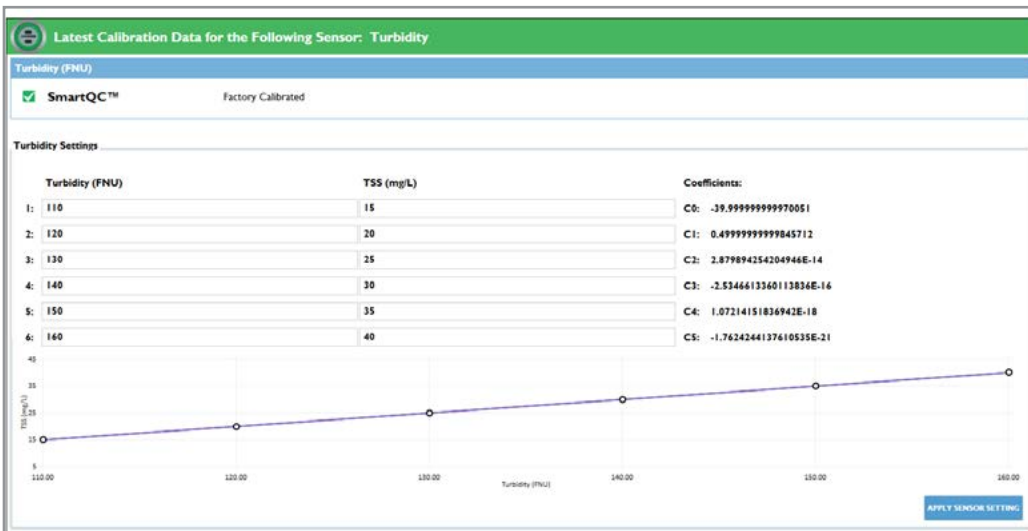

Latest Calibration Data for the Following Sensor: Turbidity

Turbidity (FNU) SmartQC™ Factory Calibrated

Turbidity Settings

Turbidity (FNU)	TSS (mg/L)	Coefficients:
1: 110	15	C0: -39.999999999970051
2: 120	20	C1: 0.49999999999845712
3: 130	25	C2: 2.879894254204946E-14
4: 140	30	C3: -2.5346613360113834E-16
5: 150	35	C4: 1.07214151826942E-18
6: 160	40	C5: -1.7624244137610535E-21

Graph: Y-axis is TSS (mg/L), X-axis is Turbidity (FNU). A linear trend line is shown through the data points. An 'APPLY SENSOR SETTING' button is at the bottom right.

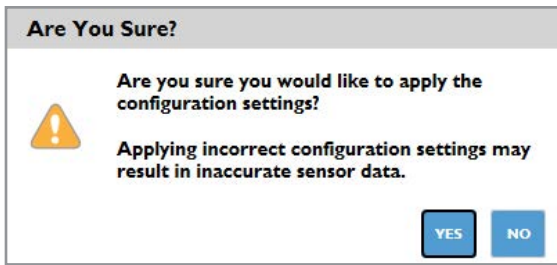

Step 4

The message below will be displayed, asking for confirmation that the settings should be applied. Click Yes.

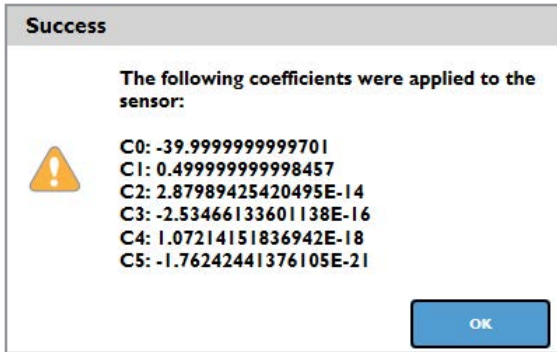

Step 5

A message box appears which states that the coefficients have been successfully applied to the sensor. The coefficients are also displayed.

Step 6

TSS values will now be displayed on the Dashboard based on the values entered via KorEXO and saved to the turbidity probe.

Step 7

If the TSS parameter is not displayed on the Dashboard, go to File>Settings>Turbidity, and click the "-" sign next to TSS Disabled to activate the TSS parameter. A "+" sign will appear and TSS Enabled will be displayed. Click Save and return to the Dashboard.

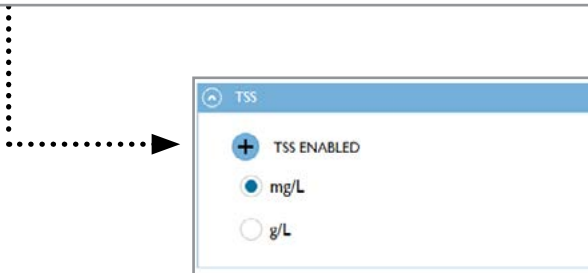
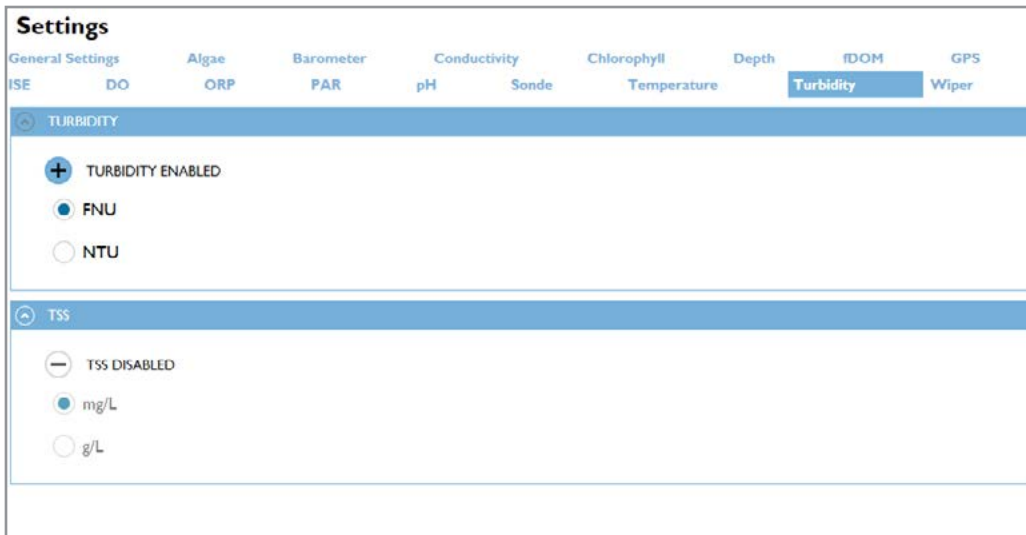

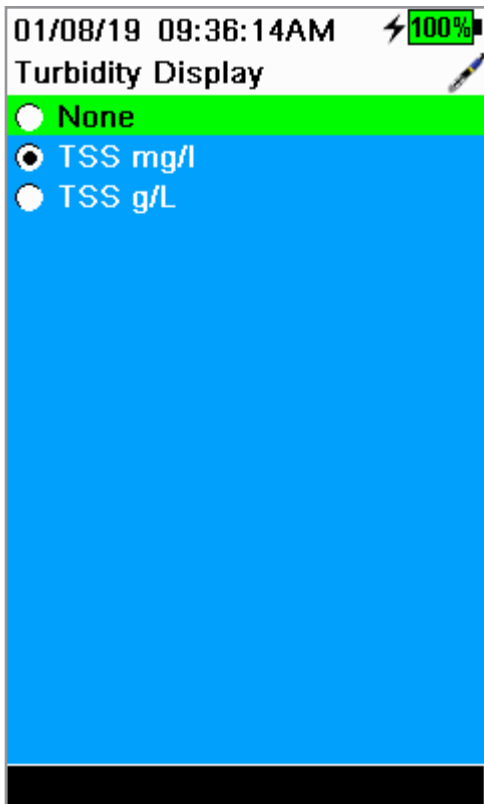

Step 8

The units to display TSS will need to be activated separately in the EXO handheld. To add the TSS parameter to the handheld, navigate to Handheld>Display>Units>Turbidity>TSS and choose which unit to display. Click "Esc" to return to the live data dashboard. TSS will be displayed.

If you wish to view the TSS coefficients in the handheld, navigate to Calibration>Turbidity>Setup and the TSS coefficients will be displayed.





Section 5

Maintenance

5.1

Sonde Storage

Proper sonde storage helps to ensure proper sonde operation. To keep sondes in their best working order, users must follow these instructions. This section will identify storage as “long-term” or “short-term.” Long-term denotes storage during times of long inactivity (over winter, end of monitoring season, etc.). Short-term denotes storage during times the sonde will be used at a regular interval (daily, weekly, biweekly, etc.).

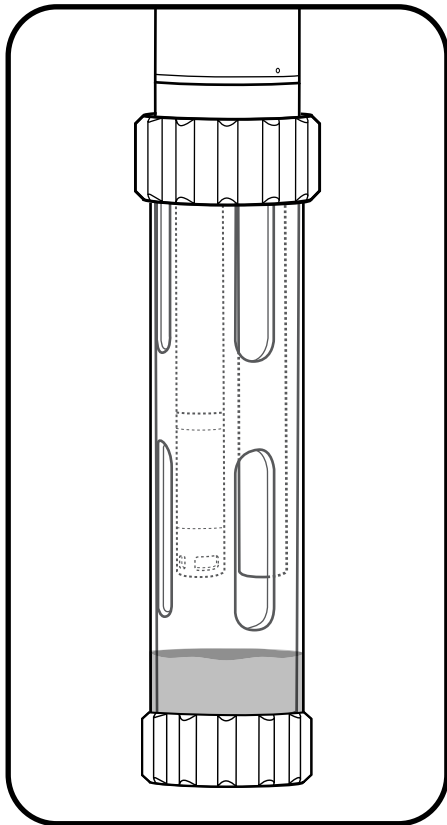

1 Short-term storage

For interim storage, users should keep sensors moist, but not submerged; submersion during storage may produce sensor drift. Users should aim for a storage environment of water-saturated air (100% humidity) for the sensors.

Place approximately 0.5 in (1 cm) of water (deionized, distilled, tap, or environmental) in the bottom of the calibration cup. Then place the sonde with all of its sensors into the cup and close it tightly to prevent evaporation. Users can also use a moist sponge to create a humid environment.

Ensure that unused sensor ports are properly protected with port plugs. The sonde itself should be stored in dry air.

To protect the cable connector, either leave the cable installed on the connector, or install the port plug. This is especially important for sondes with level; users should always keep the cable connector of vented sondes dry. (See [Section 6.5](#))

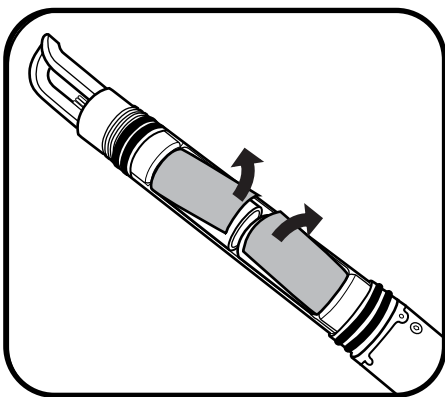

2 Long-term storage

Store all removed sensors according to the specific instructions in their sensor storage section. Plug all open ports, and store the sonde according the above instructions for short-term sonde storage.

NOTICE: Always remove batteries from sondes during long periods of inactivity to prevent potentially harmful battery leaks.

5.2

Sonde Maintenance

Like all precision equipment, EXO sondes work most reliably when users maintain them properly. A proper inspection and cleaning can prevent several issues, including leaks. When performing general maintenance on the sonde, also check this manual's depth and connector sections. Use only the recommended materials to service instruments. Each sonde comes with a maintenance kit, including proper lubricants and replacement o-rings. Users can order replacement o-ring kits (599680 or 599681) or tool kit (599594) from the manufacturer or an authorized distributor.

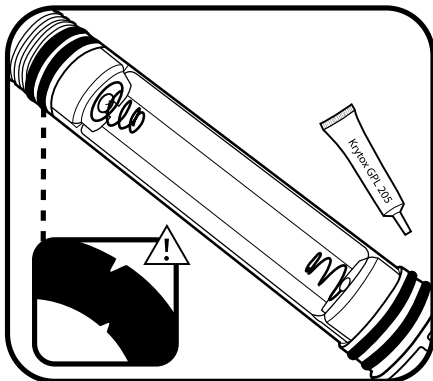

1 Inspect and service o-rings

User-serviceable o-rings are located in the EXO sonde battery compartments. Perform a thorough visual inspection of o-rings each time they are exposed. Carefully look for grit, hair, etc. on the o-ring and mating surfaces and wipe away any contamination with a lint-free cloth. Without removing them from their grooves, *lightly* grease each o-ring with Krytox. Replace any damaged o-rings.

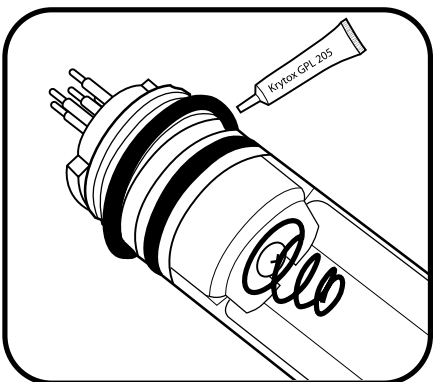

2 Replace o-rings

If the above inspection reveals a damaged (split, cracked, or misshapen) o-ring, remove it. Wipe the groove clean with alcohol and a lint-free cloth. Grease the o-ring by drawing it between your *lightly* greased thumb and index fingers. Place the o-ring in its groove, being careful to not roll or twist it, and lightly grease the surface. Inspect the o-ring for contamination.

NOTICE: Do not apply excess grease to the o-rings. This can cause contamination and seal failure.

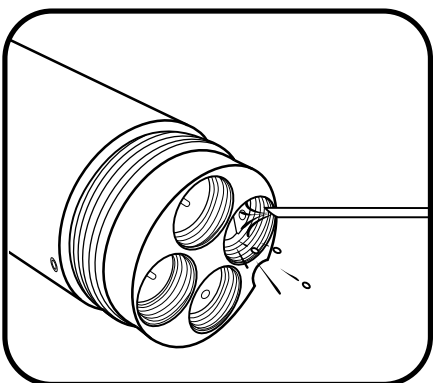

3 Inspect, clean, and grease ports

Visually inspect each port for contamination (grit, hair, etc.). Should the user detect contamination, remove it with a blast of compressed air. When the port's rubber appears dry, lightly grease the sensor connector before insertion.

NOTICE: Never insert solid objects into the sonde ports. This could permanently damage the connectors.

5.3

Sonde

Replace EXO1 Sonde Bail

Sonde bails provide users with a handle for convenient transport and an attachment point for cable strain reliefs. If an EXO1 bail breaks due to impact or standard wear and tear throughout the life of the sonde, a user can easily replace it. We also recommend attaching the cable's strain relief mechanism to the bail.

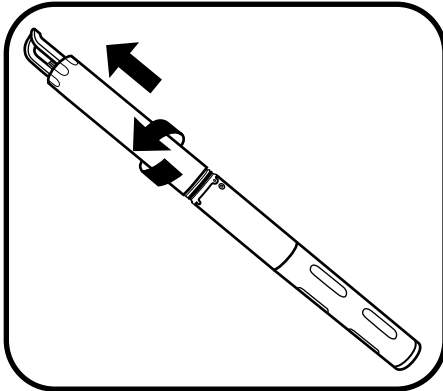

1 Remove battery cover

Twist the battery cover counterclockwise until free. Then slide off the battery cover.

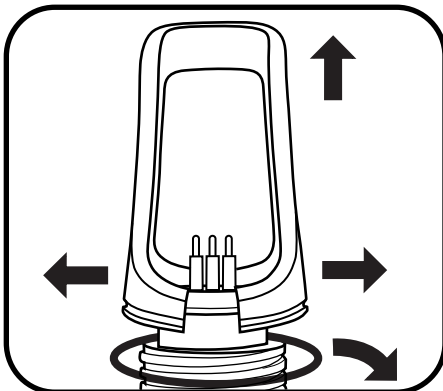

2 Remove bail

Spread the sides of the bail away from the connector, pull the bail over the posts on top of the sonde, and remove the o-ring from its groove and discard.

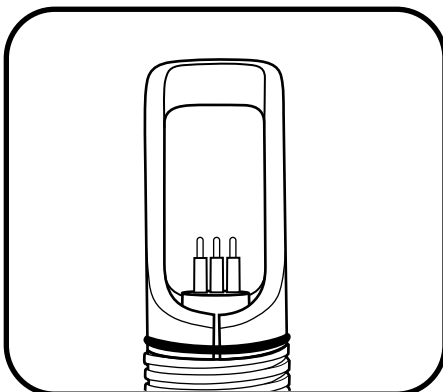

3 Install new bail

Install a new o-ring in the groove at the base of the bail. Then carefully spread the bail open and seat its sockets over the posts around the connector.

5.4

Sonde

Replace EXO2 and EXO3 Sonde Bail

Sonde bails provide users with a handle for convenient transport and an attachment point for cable strain reliefs. If an EXO2 or EXO3 bail breaks due to impact or standard wear and tear throughout the life of the sonde, a user can easily replace it. We also recommend attaching the cable's strain relief mechanism to the bail.

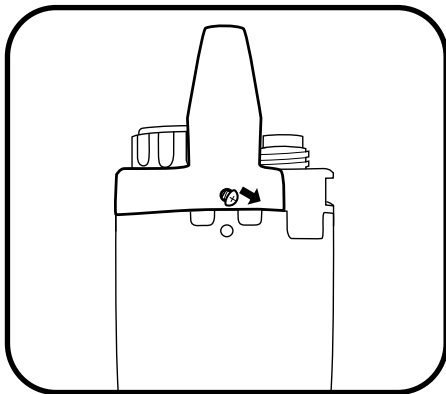

1 Remove bail

Use a small screwdriver to remove two screws on the sides of the bail.

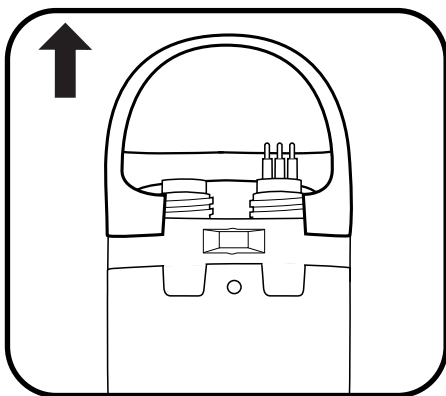

Once screws are removed, lift the bail off the sonde.

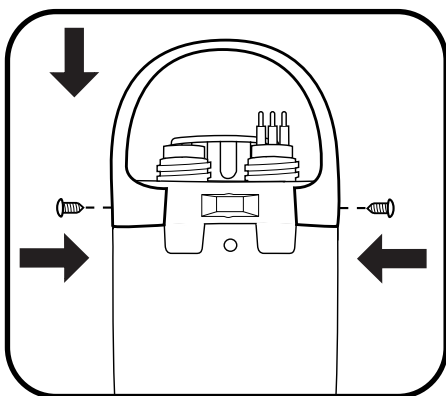

2 Install new bail

Place the new bail onto the sonde, aligning holes for the screws. With one side of the bail aligned, push on the other side to snap it into place. Use a small screwdriver to insert two screws on the sides of the bail. Tighten until snug.

5.5

Depth and Level Sensor Maintenance and Storage

EXO depth and level sensors access the water through small holes (ports) located in the sonde body or bulkhead. Although users cannot access them directly, proper storage and maintenance will help to ensure reliable operation. Depth sensors can be stored dry, in water-saturated air, or submerged in clean water. However, be sure that the water does not contain solutions that are corrosive. This can cause damage to the sensor's strain gauge.

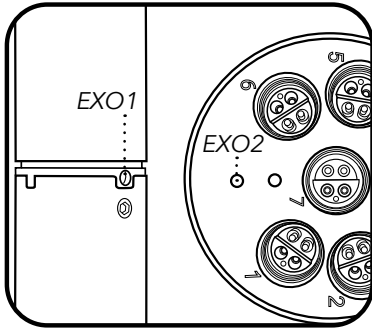

1 Locate depth ports

The two EXO1 depth ports are located in the yellow-plastic section between the bulkhead tube (labeled area) and the blue plastic battery cover. The EXO2 / EXO3 depth ports are located on the metal bulkhead face itself, in the largest open area between ports.

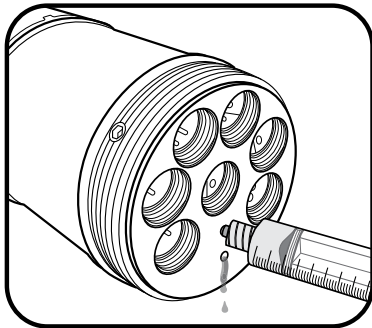

2 Clean depth ports

Although users cannot directly access the depth/level sensors, they should periodically clean them with the syringe included in the EXO tool kit (599594). Fill the syringe with clean water and gently force water through one of the ports. Ensure that water flows from the other hole. Continue flushing the port until the water comes out clean.

NOTICE: Do not insert objects in the depth ports, as this may cause damage to the transducer not covered under the warranty.

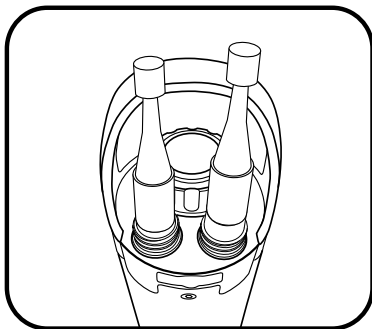

3 Level sensor storage

Users can store these sensors either dry or submerged in clean water. However, regardless of storage method or length, ensure the vent tube remains dry. Always attach the port plug to the cable connector, or leave the cable installed with a cap over the desiccant's vent.

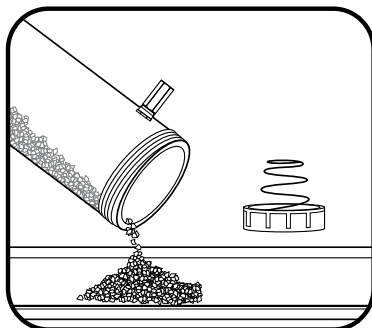

4 Level desiccant maintenance

Active desiccant is blue; saturated desiccant is pink. When the desiccant closest to the sonde begins to turn pink, you should replace (YSI 6108), or regenerate (YSI 6109) the desiccant cartridge. To regenerate desiccant, remove it from the cartridge and heat it for one hour at 200°C (about 400°F); then cool it in an airtight container before refilling. Also heat the felt filters at 100°C (about 200°F) for 30 minutes. The desiccant will turn blue following a successful recharge.

5.6

Standard Optical Sensors Maintenance and Storage

Standard optical sensors include Turbidity, Total Algae, and fDOM sensors; these optical sensors are very low maintenance. This section identifies storage as “long-term” or “short-term.” Long-term denotes storage during times of long inactivity (over winter, end of monitoring season, etc.). Short-term denotes storage during times the sonde will be used at a regular interval (daily, weekly, biweekly, etc.).

NOTE: It is important to make sure the sensor connector is lubricated prior to installation. Maintain connectors as instructed in [Section 5.17](#).

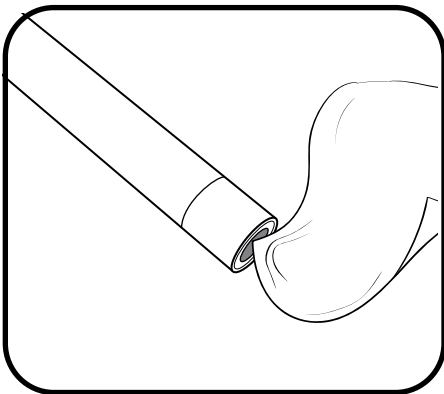

1 Clean sensing window

Turbidity, Total Algae, and fDOM require minimal maintenance. Users should periodically inspect the optical surface at the tip of the sensor and wipe it clean with a non-abrasive, lint-free cloth if necessary. As much as possible, prevent scratches and damage to the sensing window.

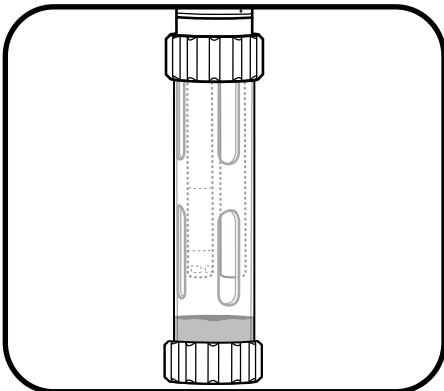

2 Long- and short-term storage

Turbidity, Total Algae, and fDOM require minimal precautions. Users can either remove the sensors or leave them installed in the sonde for long- and short-term storage. If left installed on the sonde, follow guidelines for sonde storage. If users remove them from the sonde, the sensors may be stored in dry air in their shipping cap (to protect against physical damage).

NOTICE: Do not store any sensor in quinine sulfate solution.

5.7

Conductivity/Temp Sensor Maintenance and Storage

EXO conductivity and temperature (CT) sensors require little maintenance or special attention for storage. As much as possible, prevent impact to the sensor's exposed thermistor. This section will identify storage as "long-term" or "short-term." Long-term denotes storage during times of long inactivity (over-wintering, end of monitoring season, etc.). Short-term denotes storage during times the sonde will be used at a regular interval (daily, weekly, biweekly, etc.).

NOTE: It is important to make sure the sensor connection is lubricated prior to installation. Maintain connectors as instructed in [Section 5.17](#).

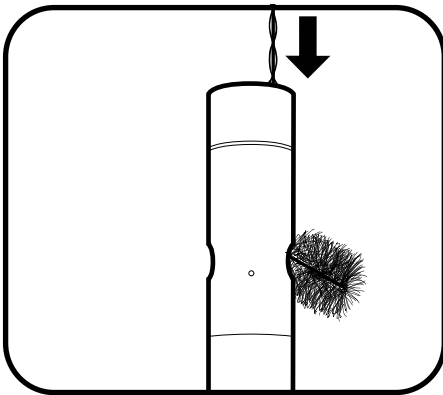

1 Clean electrode channels

The only parts of the CT sensor that require special maintenance are the channels leading to the internal electrodes. Dip the sensor's cleaning brush (included in the sonde maintenance kit) in clean water, insert at top of channels, and sweep the channels 15-20 times. If deposits have formed on the electrodes, use a mild solution of dish soap and water to brush the channels. If necessary, soak in white vinegar to aid cleaning. Rinse the channels with clean water following the sweepings or soak.

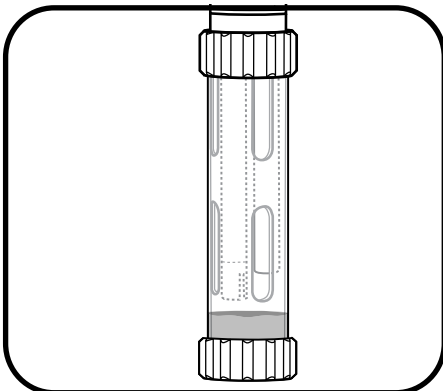

2 Short-term storage

When in regular field use, the sensor should remain installed on the sonde in an environment of water-saturated air. Place approximately 0.5 in (1 cm) of any water (deionized, distilled, tap, or environmental) in the bottom of the calibration cup. Insert the sonde and sensor into the cup and screw it on tightly to prevent evaporation. (More information in "Short-Term Sonde Storage" [Section 5.1](#).)

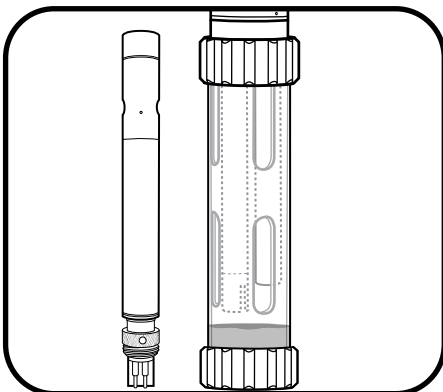

3 Long-term storage

Store the sensors either dry or wet, installed on the sonde or detached. However, before storage, perform the recommended maintenance (above) to ensure the sensor is in good working order for the next deployment season. If the sensor is submerged for storage, ensure that the liquid is not corrosive.

5.8

Dissolved Oxygen Sensor Storage

EXO DO sensors require separate storage instructions from other optical sensors due to their sensing membranes. This section will identify storage as “long-term” or “short-term.” Long-term denotes storage during times of long inactivity (over winter, end of monitoring season, etc.). Short-term denotes storage during times the sonde will be used at a regular interval (daily, weekly, biweekly, etc.).

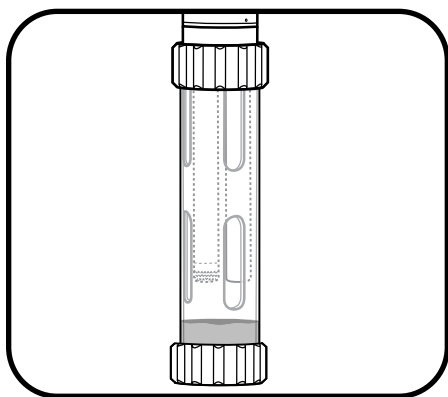

1 Short-term storage

When in regular field use, the ODO sensor should remain installed on the sonde. Place approximately 0.5 in (1 cm) of any water (deionized, distilled, tap, or environmental) in the bottom of the calibration cup. Insert the sonde and sensor into the cup and screw it on tightly to prevent evaporation. (More information in “Short-Term Sonde Storage” [Section 5.1.](#))

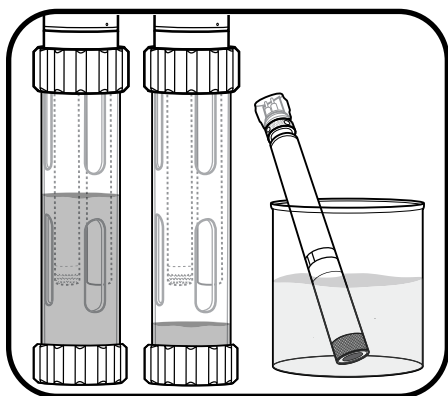

2 Long-term storage

Leave the sensor installed in the sonde, and submerge it in clean water in the calibration cup. Screw the cup on tightly to prevent evaporation. Users may also store the ODO sensor by itself in two ways. One, submerge the sensing end of the sensor in a container of water; occasionally check the level of the water to ensure that it does not evaporate. Two, store the sensor in water-saturated air.

We do not recommend storing the sensor with the connector end unmated or exposed. If unmated, cover with plastic connector cap.

5.9

Dissolved Oxygen Sensor Maintenance and Rehydration

EXO optical Dissolved Oxygen (DO) sensors require unique maintenance instructions due to their sensing membranes. Users should routinely perform these steps in order to achieve the highest levels of sensor accuracy. DO sensor caps have a typical life of 12 months. After this point, users should replace the DO membrane cap. As caps age, accuracy may be reduced, ambient light rejection suffers, and response times can be affected.

NOTE: It is important to make sure the sensor connector is lubricated prior to installation. Maintain connectors as instructed in [Section 5.17](#).

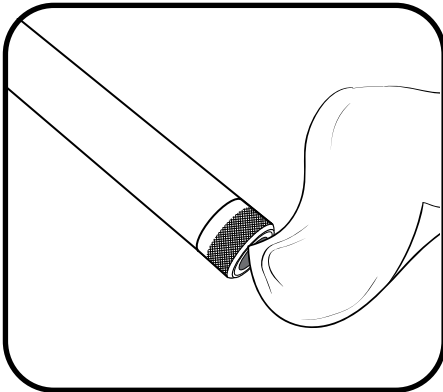

1 DO membrane maintenance

Users should periodically inspect the optical surface at the tip of the sensor and wipe it clean with a non-abrasive, lint-free cloth if necessary. Never use organic solvents to clean an EXO DO sensor.

As much as possible, prevent scratches and damage to the sapphire sensing window. Avoid getting fingerprints on the window. If necessary, wash with warm water and dish soap and rinse with DI water.

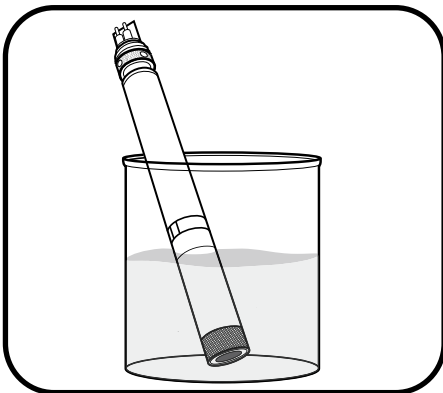

2 Sensor rehydration

Users should always store DO sensors in a moist or wet environment in order to prevent sensor drift. However, should DO sensors be left in dry air for longer than eight hours, they must be rehydrated. To rehydrate, soak the DO sensor cap in warm (room temperature) tap water for approximately 24 hours. Following this soak, calibrate the sensor and store it in a moist environment.

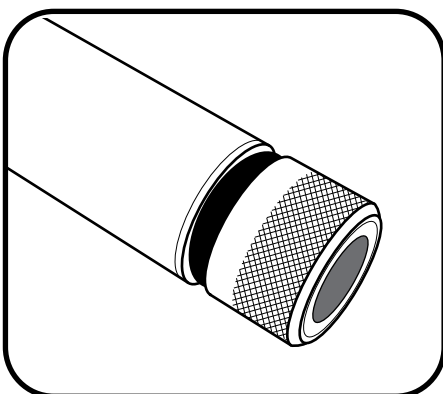

3 Sensor cap replacement

DO sensor caps have a typical life of 12 months. After this point, users should replace the DO membrane cap. To replace this cap, follow the directions in the "Sensor Cap Replacement" section found on the next page.

5.10

Dissolved Oxygen Sensor Sensor Cap Replacement

Follow these instructions to replace the sensor cap on an EXO optical dissolved oxygen sensor once the previous cap has exhausted its usable life (typically about one year). The DO sensor cap (599110-01) is shipped in a humidified container, and should be stored in a 100% humid environment.

NOTE: Keep the instruction sheet shipped with the DO sensor cap as it contains the unique coefficients required for calibration. If the sensor cap dries completely, follow instructions to rehydrate it.

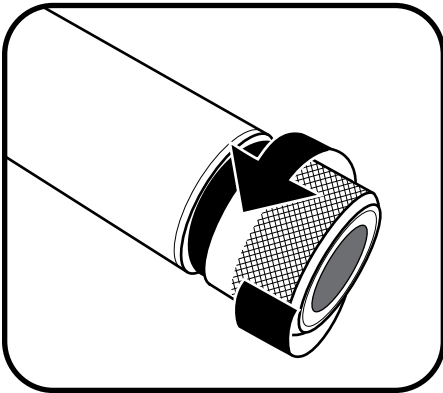

1 Remove current sensor cap

Rotate the sensor cap with your fingers counterclockwise until free.

If possible, do not use any tools during this process. However, should the cap be immovable after use, carefully twist the sensor cap with pliers until it breaks loose.

NOTICE: Do not use pliers on the sensor body, and take great care not to damage the sensor threads.



2 Replace o-ring

Without using tools, remove the previous o-ring (pinch the o-ring out, then roll it upwards over the threads) and discard it. Visually inspect the new o-ring for nicks, tears, contaminants, or particles; discard damaged o-rings. Without twisting it, carefully install the new o-ring over the threads and into its groove, then apply a thin coat of Krytox lubricant to the o-ring only.

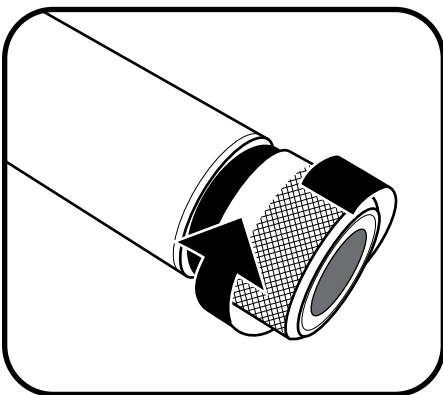

3 Install new sensor cap

After the o-ring is installed and lubricated, wipe the clear window at the end of the sensor with a lint-free cloth until clean. Then dry the inside cavity of the sensor cap with a lint-free cloth. With a clockwise motion, thread the new sensor cap onto the sensor until it is finger-tight. The o-ring should now be compressed between the sensor cap and sensor, and not pinched. If pinched, remove and discard the o-ring and repeat procedure.

NOTICE: Do not over-tighten the sensor cap. Do not use any tools for the installation process.

4 Configure sonde for new cap

Connect the sonde to KorEXO and navigate to the Instrument and Sensors tab. Select the ODO sensor.

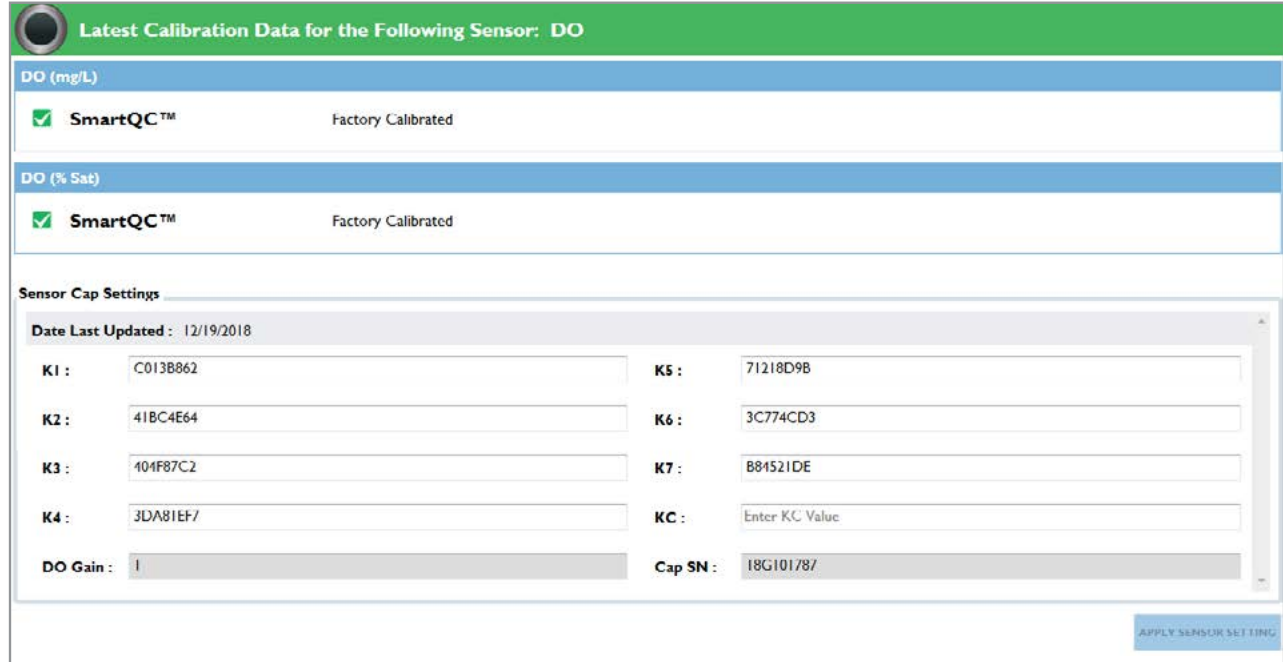

The screenshot displays the 'Latest Calibration Data for the Following Sensor: DO' section. It shows two rows for DO (mg/L) and DO (% Sat), both with 'SmartQC™' and 'Factory Calibrated' status. Below this is the 'Sensor Cap Settings' section, which includes a 'Date Last Updated' of 12/19/2018 and a grid of input fields for coefficients K1 through K7, DO Gain, and Cap SN. The values are: K1: C013B862, K2: 41BC4E64, K3: 404F87C2, K4: 3DA81EF7, K5: 71218D9B, K6: 3C774CD3, K7: B84521DE, DO Gain: 1, and Cap SN: 18G101787. An 'APPLY SENSOR SETTINGS' button is located at the bottom right.

Sensor Cap Settings	
Date Last Updated : 12/19/2018	
K1 :	C013B862
K2 :	41BC4E64
K3 :	404F87C2
K4 :	3DA81EF7
K5 :	71218D9B
K6 :	3C774CD3
K7 :	B84521DE
DO Gain :	1
Cap SN :	18G101787

In the DO screen, enter the unique membrane cap coefficients found on the instruction sheet shipped with the DO sensor cap. Click Apply Sensor Settings to save the changes.

NOTE: The Cap SN will updated after the user disconnects and reconnects the sonde to KorEXO Software.

NOTE: Calibration coefficients are associated with specific individual sensor caps. They cannot be used for other ODO sensors.

Although measures are taken at the factory to ensure this, please check that the serial number with the calibration coefficients on the instruction sheet matches the serial number engraved on the outside of the sensor cap.

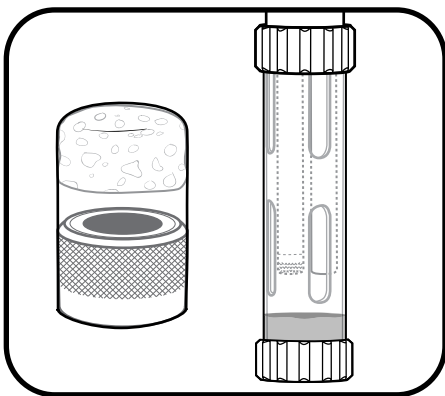

5 Store sensor cap

The sensor cap is shipped in a humidified container, and should be consistently stored in a 100% humid environment. Prior to installation, ensure the cap's container remains moist. Once the sensor cap is installed on the sensor, maintain this environment by placing approximately 0.5 in (1 cm) of water (deionized, distilled, tap, or environmental) in the bottom of the calibration cup and screw it tightly onto the sonde to prevent evaporation. You may also store the sensor by submerging the cap end in water.

NOTICE: If pH sensor is also installed, do not submerge it in *distilled* water.

5.11 pH and pH/ORP Sensors

Storage and Rehydration

pH and pH/ORP sensors have two specific storage requirements: they should not be stored in distilled or deionized water and their reference electrode junction should never dry out. This section will identify storage as “long-term” or “short-term.” Long-term denotes storage during times of long inactivity (over-wintering, end of monitoring season, etc.). Short-term denotes storage during times the sonde will be used at a regular interval (daily, weekly, biweekly, etc.).

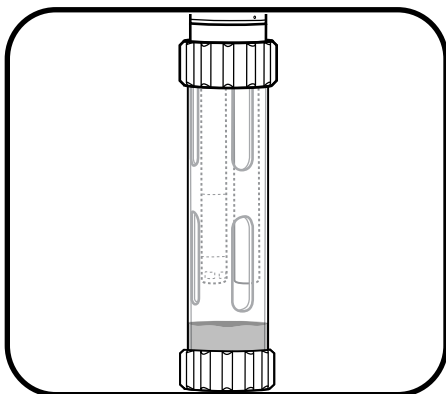

1 Short-term storage

When in regular field use, the sensor should remain installed on the sonde in an environment of water-saturated air. Place approximately 0.5 in (1 cm) of any water (deionized, distilled, tap, or environmental) in the bottom of the calibration cup. Insert the sonde and sensor into the cup and screw it on tightly to prevent evaporation. (More information in “Short-Term Sonde Storage” [Section 5.1.](#))

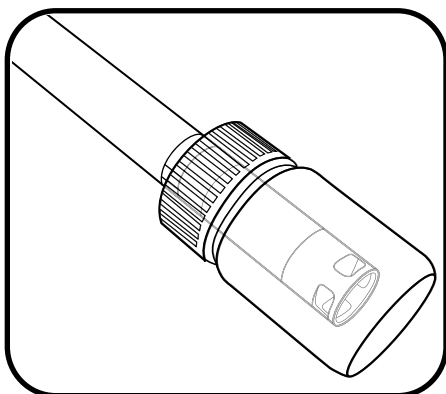

2 Long-term storage

Remove the sensor from the sonde and insert its sensing end into the bottle that the sensor was shipped in. Install the bottle's o-ring and cap then tighten. This bottle contains a 2 molar solution of pH 4 buffer. If this solution is unavailable, users may store the sensor in tap water.

NOTICE: Do not store the pH or pH/ORP sensor in Zobell solution, DI or distilled water.

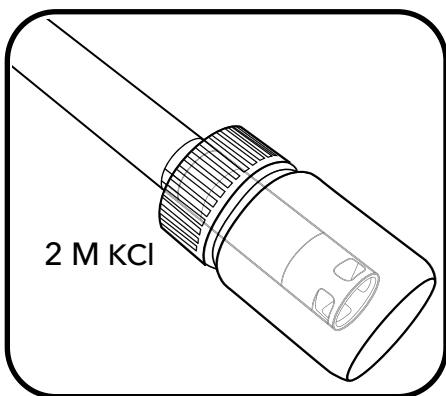

3 Rehydrate reference junction

If the pH sensor has been allowed to dry, soak the sensor for several hours (preferably overnight) in a 2 molar (2 M) solution of potassium chloride (KCl). In order to create a 2 M KCl solution, dissolve 74.6 g of KCl in 500 mL of distilled or deionized water. If KCl is unavailable, a tap water or pH 4 buffer soak may restore function. If the sensor is irreparably damaged, users must replace the sensor module.

5.12

pH and pH/ORP Sensors Maintenance

pH and pH/ORP sensors will require occasional maintenance to clear contamination from the sensing elements. These contaminants can slow the sensor's response time. Clean the sensors whenever deposits, biofouling, or other contamination appear on the glass, or when the sensor's response time slows perceptibly. Remove the sensor from the sonde before performing the following cleaning steps. Do not attempt to physically scrub or swab the glass bulbs. The bulbs are very fragile and will break if pressed with sufficient force.

NOTE: It is important to make sure the sensor connector is lubricated prior to installation. Maintain connectors as instructed in [Section 5.17](#).

Replace depleted sensor module as instructed in [Section 5.14](#).

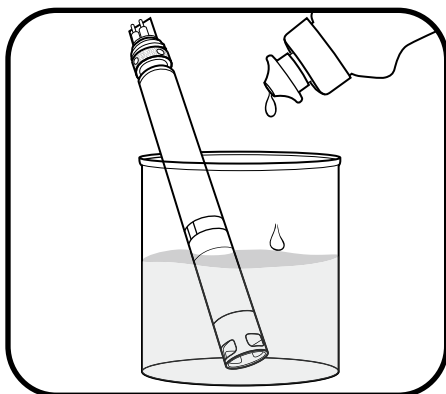

1 Soak in dishwashing liquid solution

Soak the sensor for 10-15 minutes in a solution of clean tap water and a few drops of dishwashing liquid. Following the soak, rinse the sensor with clean water and inspect. If contaminants remain or response time does not improve, continue to the HCl soak.

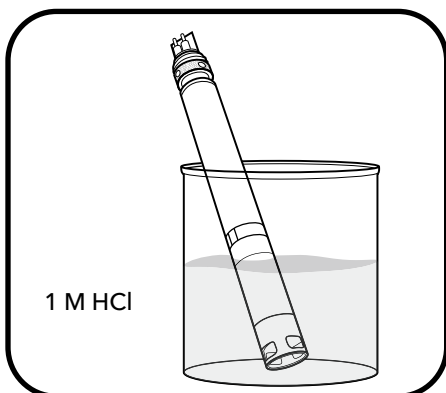

2 Soak in HCl solution

Soak the sensor for 30-60 minutes in one molar (1 M) hydrochloric acid (HCl). This reagent can be purchased from most distributors. Following the HCl soak, rinse the sensor in clean tap water and allow it to soak for an hour in clean water. Stir the water occasionally. Then, rinse the sensor again in tap water and test response time. If response time does not improve or you suspect biological contamination of the reference junction, continue to the next soak. If HCl is not available, soak in white vinegar.



WARNING: Follow the HCl manufacturer's instructions carefully to avoid personal harm.

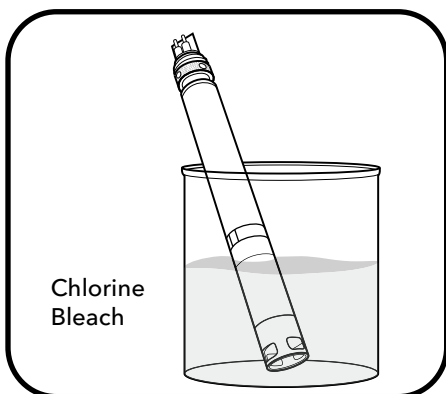

3 Soak in chlorine bleach solution

Soak the sensor for approximately one hour in a 1:1 dilution of chlorine bleach and tap water. Following the soak, rinse the sensor in clean tap water and allow it to soak for at least one hour in clean water (longer if possible). Then, rinse the sensor again in tap water and test response time.

5.13

ISE Sensors Maintenance and Storage

EXO ammonium, nitrate, and chloride sensors utilize ion-selective electrodes (ISEs) to monitor these parameters. One key requirement of storage, short or long-term, for these sensors is that their reference electrode junctions should never dry out. This section will identify storage as “long-term” or “short-term.” Long-term denotes storage during times of long inactivity (overwintering, end of monitoring season, etc.). Short-term denotes storage during times the sonde will be used at a regular interval (daily, weekly, biweekly, etc.) Replace depleted sensor module as instructed in [Section 5.14](#).

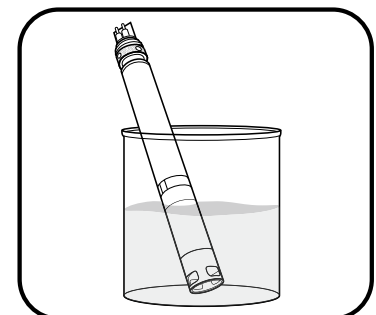
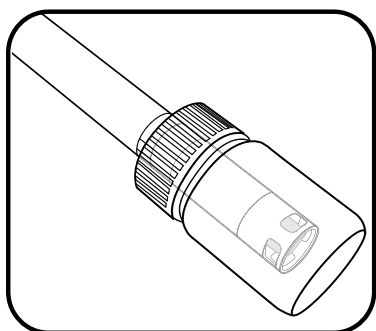
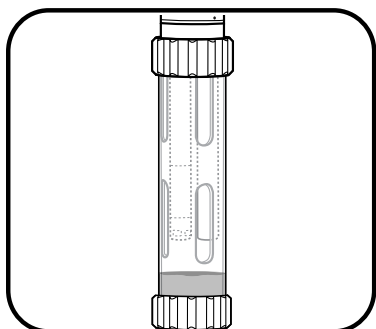
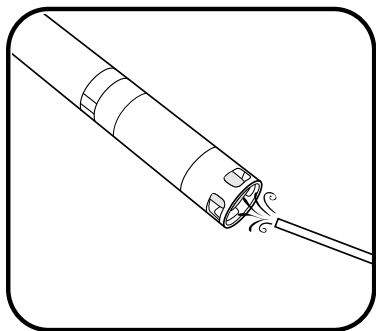

1 Sensor maintenance

Ammonium or Nitrate sensor: When deposits, biofouling, or other contamination appear on the membrane, users should *gently* remove them with a fine jet of deionized water or rinsing in alcohol followed by soaking in the high standard calibration solution. Gently dab dry with a lint-free tissue.

Chloride sensor: When deposits, biofouling, or other contamination appear on the membrane, users should *gently* remove them by washing with alcohol and/or gently polishing with fine emery paper in a circular motion to remove deposits or discoloration, then thoroughly washing with deionized water to remove any debris.

NOTICE: The ion-selective membranes are very fragile. Do not use coarse materials (e.g. paper towels) to clean the membranes, as these could permanently damage the sensor. The exception is fine emery paper for the chloride sensor, noted above.

2 Short-term storage

When in regular field use, the sensor should remain installed on the sonde in an environment of water-saturated air. Place approximately 0.5 in (1 cm) of any water (deionized, distilled, tap, or environmental) in the bottom of the calibration cup. Insert the sonde and sensor into the cup and screw it on tightly to prevent evaporation. (More information in “Short-Term Sonde Storage” [Section 5.1](#).)

3 Long-term storage

Users should remove the sensors from the sonde and place them in their dry storage bottle (installed on sensor during shipping) to protect the sensor tip.

NOTICE: Do not store the ISE sensors in any water or standard solution.

4 Rehydrate reference junction

After an ISE sensor has been allowed to dry, soak the sensor for several hours (preferably overnight) in the sensor’s high-calibration solution.

5.14 Sensor Module Replacement

EXO pH, pH/ORP, ammonium, nitrate, and chloride sensors feature replaceable sensor modules (#599795, 599797, 599743-01, 599744-01, 599745-01) due to the electrolyte-depleting characteristics necessary to make such measurements. We recommend that users replace these modules as necessary—typically 12 to 18 months for pH and ORP and three to six months for ISEs, when stored properly. Working life will depend on the conditions of the deployment environment. Perform this procedure in a clean, dry laboratory environment.

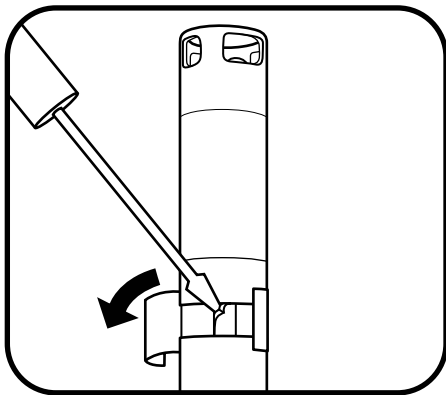

1 Remove old sticker and plug

Peel off and discard the old sticker that covers the junction of the sensor body and the module. Then, with a small, flat-blade screwdriver, remove the small rubber plug from the gap in the hard plastic ring at the base of the sensor module.



CAUTION: Always exercise extra care when using sharp or potentially harmful instruments.

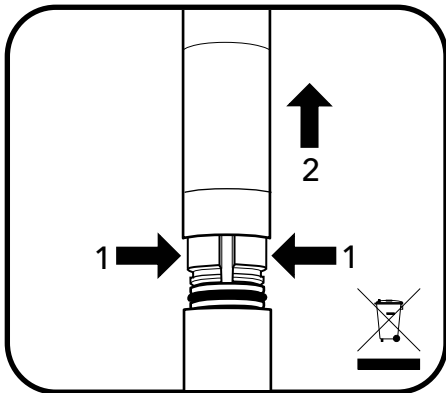

2 Remove and discard old sensor module

To remove, perform two motions simultaneously.

1. With your fingers, squeeze the sensor module's hard plastic ring so that it compresses the gap left by the rubber plug.
2. Steadily pull the sensor module straight back from the sensor body, rocking slightly if necessary.

NOTICE: The act of removing the old sensor module renders the o-rings on the module unusable. To prevent catastrophic leaks, do not attempt to reinstall a module with damaged o-rings. Discard the module and the old o-rings according to your organization's guidelines, or return it to manufacturer for recycling.

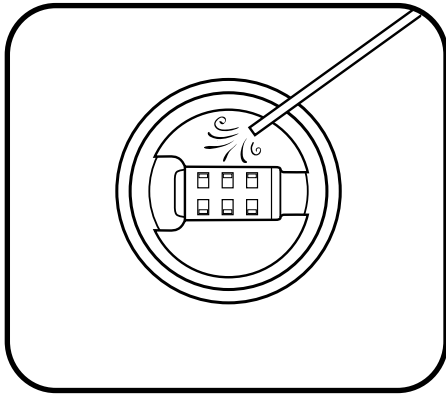

3 Inspect and service connector cavity

Inspect the connector cavity of the probe body for debris or moisture.

If detected, remove it with a lint-free cloth or a gentle blast of compressed air.

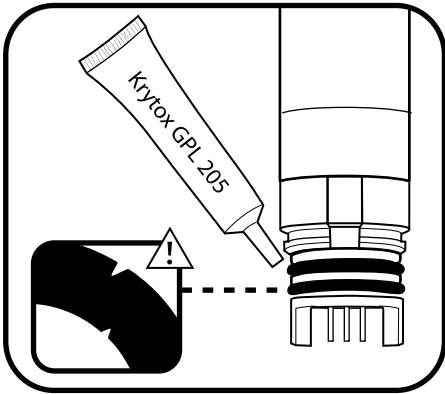

4 Inspect and service new sensor module's o-rings

Ensure that the two o-rings are not nicked or torn and have no contaminants or particles on them. If the user detects damage, carefully replace them with the extras included in the sensor module kit. Then apply a thin coat of Krytox® lubricant to each o-ring. If a user removes a sensor module that is in good working order, replace the o-rings before use.

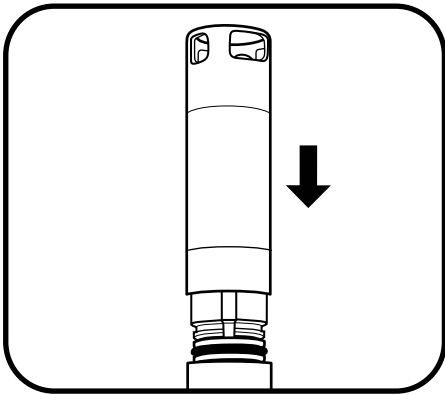

5 Insert new sensor module

Align the prongs on the base of the module with the slots in the sensor body. The sensor module is keyed to insert in only one orientation. Once the module is aligned, press it firmly into position until it clicks. Wipe away any excess grease from the assembled components.

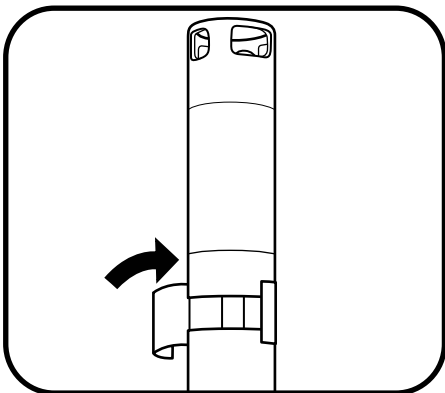

6 Apply new sticker

Wrap the junction of the sensor module and the body with the new sticker included in the sensor module kit. This sticker helps keep the sensor module junction clean and retains the rubber plug throughout deployment.

On the sticker, use a permanent marker to write the date the replacement module was installed, as a reminder.

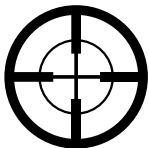

7 Re-calibrate the sensor

Using KorEXO software, calibrate the sensor following each sensor module replacement. After calibration, the sensor is ready for field use.

5.15 EXO Central Wiper

Maintenance and Storage

Follow these instructions to replace the wiper brush assembly or brush guard component on the central wiper. We recommend changing the brush between deployments to avoid sediment carryover, which can compromise calibration and data collection. For long- and short-term storage, the wiper requires minimal precautions. Users can either remove the wiper or leave it installed in the sonde. If left installed on the sonde, follow guidelines for sonde storage. If users remove it from the sonde, the wiper may be stored in dry air in its shipping cap to protect against physical damage.

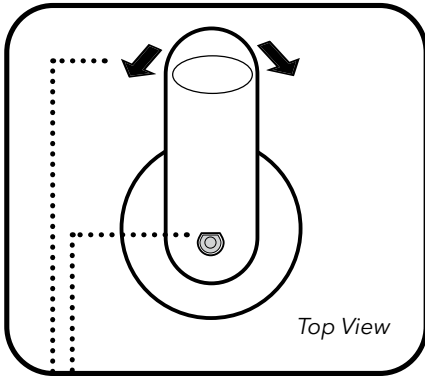

Top View

Align set screw in D shaft
Rock brush back and forth

1 Replace wiper brush

Loosen set screw with a 0.050 inch Allen wrench. Remove old brush assembly and clean any residue from wiper shaft and wiper end cap.

Install new brush assembly, gently pressing the wiper arm down against the shoulder on the wiper shaft.

Tighten set screw to a torque of 4 inch-pounds. While tightening, gently and slowly rock the brush to ensure a tight fit against the D shaft.

Check snugness of wiper by gently rocking 5 degrees in either direction.

2 Replace brush guard

In KorEXO software, go to Run > Dashboard. Click the Wipe Sensors button to ensure proper wiper park position.

Mark the position of the old guard with a marker.

Loosen the #6 screw with a 7/64 inch Allen wrench, remove the old guard and clean any residue from motor housing.

Remove the cover on adhesive strip on the inside of the new brush guard.

Carefully install the new brush guard in same position as old guard—with brush centered in well. Tighten screw until snug, but do not overtighten. (The adhesive helps to hold the guard in place.)

If necessary, calibrate the position of the new wiper in the KorEXO Calibrate menu.

NOTE: The adhesive on the guard strap, which facilitates installation, may make it difficult to re-position the wiper guard after it's been installed. Take caution to mark the position of the old guard before removing it and install the new one in the same location. Confirm that the new guard is aligned with the 4-pin connector at the bottom of the probe as shown, and properly centered between ports 1 and 6 after the wiper has been installed in the sonde.

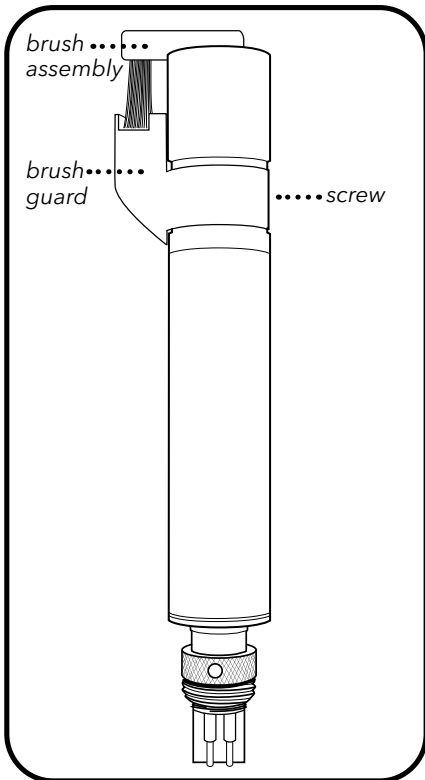

Central Wiper O-Ring Replacement



In order to minimize the chance of water infiltration, YSI recommends annual replacement of the wiper shaft o-rings inside the EXO Central Wiper. This replacement must be performed by a YSI Authorized Service Center. EXO Authorized Service Centers are located in the United States and around the world. Please refer to the YSI website ([YSI.com/Repair](https://www.ysi.com/Repair)) for your nearest Authorized Service Center.

SmartQC for the Central Wiper

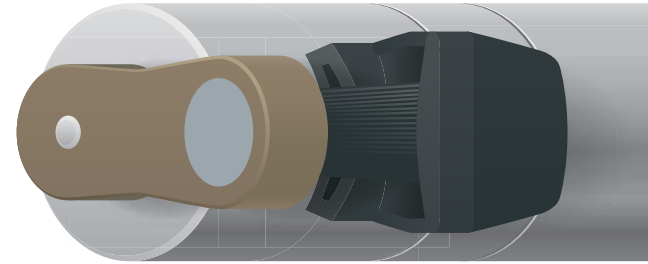
The central wiper has a QC Score based on the expected voltage of the sensor when seated in the central wiper housing. Users may adjust the seating location by selecting Wiper in the Calibration menu and selecting Jog Left or Jog Right. The seating location should be centered within the housing (brush guard)



Guidance on interpretation of the SmartQC Score for this sensor is as follows:

-  **Green:** The voltage when the wiper is seated in its housing is within the factory specified limits.
-  **Yellow:** The voltage when the wiper is seated in its housing is slightly outside of the factory specified range. If the wiper has a yellow QC Score, perform the following actions:
 1. Perform a Factory Reset Calibration.
 2. Calibrate the central wiper so that it seats itself in the correct location.
 3. Perform a series of wipes on the sonde to ensure that the wiper continues to reseat itself in the correct location after each wipe. Do not manually adjust the central wiper. The wiper calibration will associate a voltage to a location. Manually moving the wiper will negate the calibration. To perform a sensor wipe:
 - a. In KorEXO: On Live Data screen, click the "Start Wiping" button
 - b. On the Handheld: Click "Calibration" button, select "Wipe Sensors".

If the central wiper continues to show a yellow QC Score after recalibration, it is still able to be used and will wipe all of the sensors properly. However, the wiper may be nearing its time to be serviced in the factory.

-  **Red:** The voltage when the wiper is seated in its housing is outside of the factory specified limits. If the wiper has a red QC Score, perform the same three steps described above for a yellow QC Score.

If the QC Score returns to red after the above procedures when performed, please contact YSI Technical Support for further assistance. It will possibly be recommended that the wiper should be returned to the factory for maintenance.

5.16 EXO Field Cable

Maintenance and Storage

EXO field cables are rugged and provide years of reliable service when properly maintained. As with all field cables, they are most vulnerable at their connectors. Take extra caution to protect the connectors from debris and physical harm.

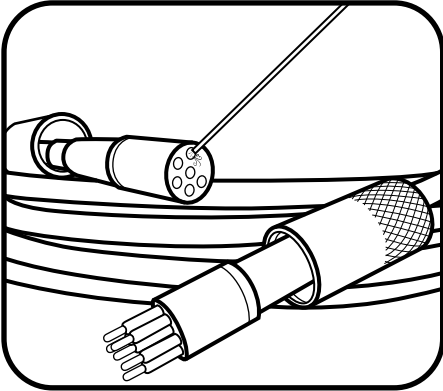

1 Inspect and clean cables

Inspect the cable's connectors for contamination and remove any detected debris with a blast of compressed air. Periodically inspect the cable for nicks and tears to ensure best performance.

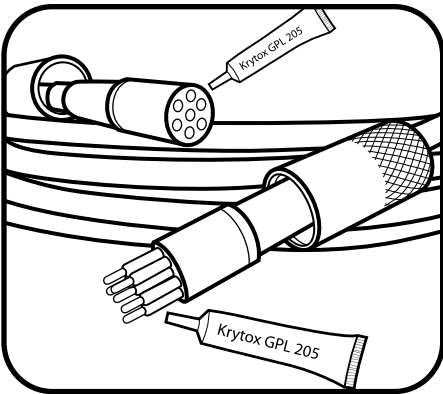

2 Lubricate cable connectors

Prior to installation, users should apply a thin coat of Krytox grease to both connector ends of the cable and the connector of the sonde. Proper lubrication will help prevent damage to the connectors.

NOTICE: Only a small coating of grease is recommended; connectors should appear shiny. Too much grease is not recommended as it can encourage contamination.

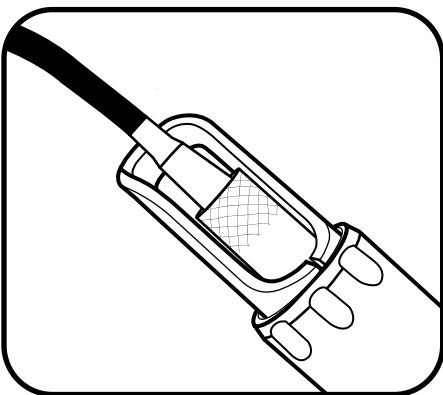

3 Cable storage

Users should leave the cable installed on the sonde to protect the connectors. If necessary users may remove it from the sonde, but extra care should be taken to protect the connectors. Store the cable in a safe location free from direct sunlight.

If the cable is vented, ensure the storage cap is affixed to the desiccant inlet. Store vented cables in a bag containing desiccant.

5.17

Connectors Maintenance and Storage

EXO sondes utilize wet-mate connectors that greatly reduce problems associated with traditional underwater connectors. However these connectors must be properly maintained to reap the full benefit of this design. Following these instructions will minimize most potential issues.

Never stick any foreign object into a female connector. Use only Krytox grease to lubricate the mating surfaces of the connectors.

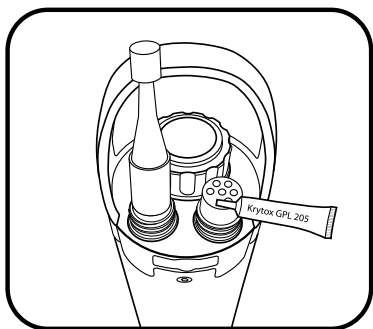

1 Female 6-pin connectors

These connectors are located on field cables, the EXO2 accessory connector, and the EXO Handheld. Periodically inspect the connectors for signs of contamination. If you detect debris, remove it with a gentle blast of compressed air. Prior to initial installation, or when dry, apply a light coat of Krytox grease to the flat rubber mating surface on top of the connector. When not in use, always install the connector's plug.

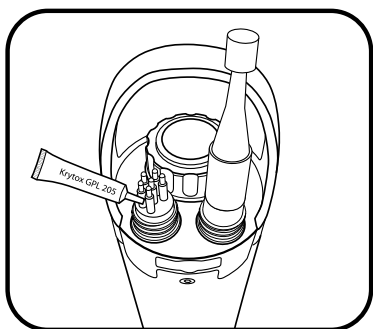

2 Male 6-pin connectors

These connectors are located on field cables and topside sonde connectors. Periodically inspect the connectors for signs of contamination. If you detect debris, carefully remove it. Prior to initial installation, or when dry, apply a light coat of Krytox grease to the rubber mating surfaces of the connector (including the rubber portions of the pins). When not in use, always install the connector's plug.

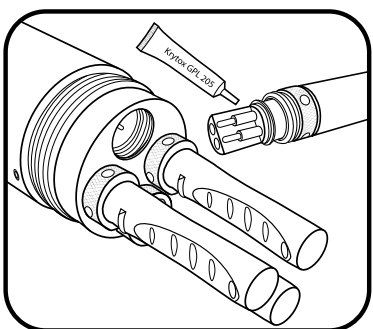

3 Sensor connectors (4-pin)

These connectors are located on sonde bulkheads (sockets) and sensors. Periodically inspect the female portions of these hermaphroditic connectors and the entire socket for contamination, and remove any debris with a gentle blast of compressed air. Prior to initial installation, or when dry, apply a light coat of Krytox grease to the rubber area of the sensor's connector.

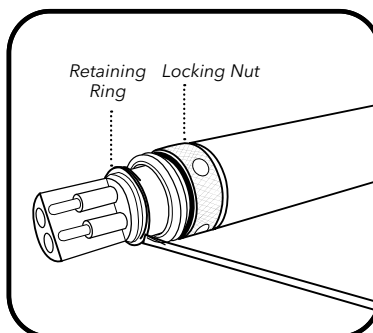

4 Replace locking nut

If the locking nut near the sensor connector wears out, users can replace it with 599668 (sensor) or 599669 (EXO central wiper).

First remove the retaining ring by inserting the tip of a small, flat-blade screwdriver under the lip of the ring and pry upward. Pull ring out of groove. Slide off locking nut and replace with new locking nut. Install new retaining ring by prying up one edge with screwdriver and fitting it into groove. Use the screwdriver to follow the diameter of the ring around the groove to seat it fully.



CAUTION: Wear eye protection when servicing the retaining ring.

5.18

Antifouling Equipment Maintenance

Many components on EXO sondes are made of an anti-fouling copper-alloy material that discourages the growth of aquatic organisms. However, longer deployment intervals and highly productive waters can result in biofouling of any equipment, so periodic cleaning may be required.

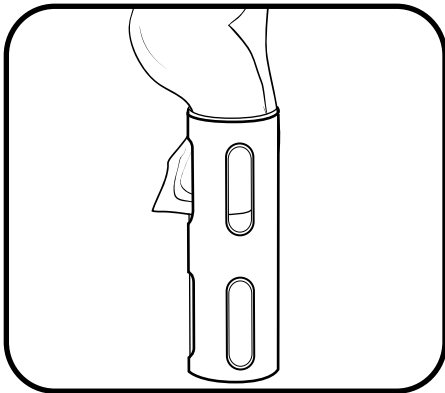

1 Remove minimal biofouling

Remove the antifouling sonde guard from the sonde. If the guard is covered in a thin layer of slime or filaments, wipe away the biofouling with a cloth soaked in clean water and a few drops of a dishwashing liquid that contains a degreaser. Rinse the guard with clean water and inspect.

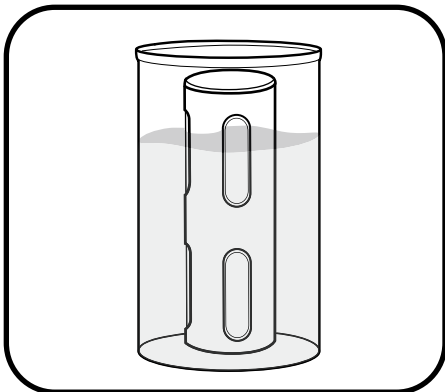

2 Soak to remove heavy biofouling

Remove the antifouling sonde guard from the sonde. If the guard is covered in a thick layer of filaments or barnacles, soak the guard for 10-15 minutes in a solution of clean water and a few drops of a dishwashing liquid that contains a degreaser. Following the soak, rinse the guard with clean water and inspect.

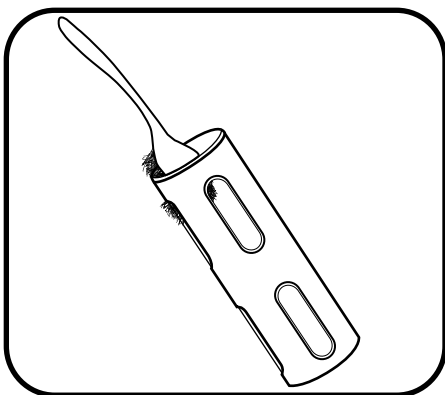

3 Scrub to remove heavy biofouling

If biofouling remains, use a small plastic scrub brush or plastic scraper to gently scrub the biofouling off the guard. Then wipe the guard with a wet, soapy cloth and rinse.

NOTICE: Do not sand or polish the inside of the guard bottom, as this may affect turbidity readings. (The guard bottom has a black coating that will eventually wear off.)

5.19 Flow Cell Maintenance

There are two versions of the EXO flow cell: EXO1 flow cell (599080) and EXO2 / EXO3 flow cell (599201). Flow rate of the flow cell is typically between 100 mL and 1 L per minute. Maximum flow rate depends on tubing type, size, and length. Maximum pressure for each is 25 psi.

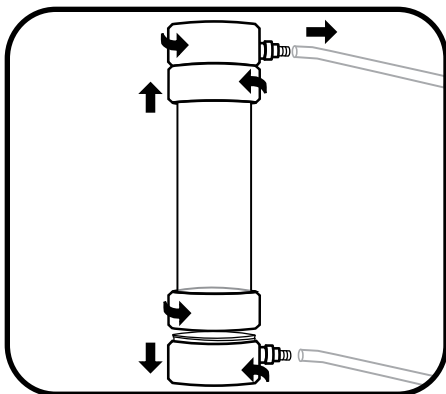

1 Disassemble flow cell

To clean the flow cell after use, unscrew and remove the sonde from the flow cell.

Take apart the flow cell by unscrewing the base from the locking ring. Remove the flow cell tube by gently pulling the base and the tube apart. The locking ring will remain on the tube due to the stainless steel retaining ring.

Repeat the same steps to remove the top of the flow cell from the flow cell tube.

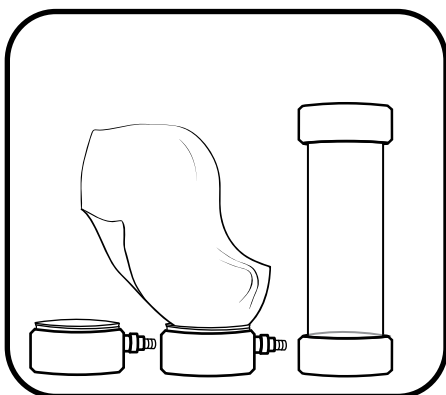

2 Clean flow cell

Use water and a mild detergent and water to wipe clean the flow cell parts.

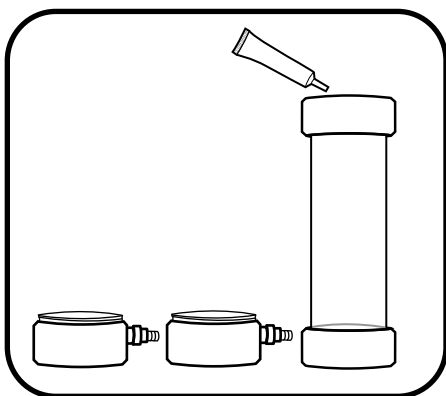

3 Reassemble flow cell

Make sure that the o-rings and threads are clean and free of any particles such as sand, grit, or debris. Apply a thin coat of Krytox grease to the two o-rings on the flow cell tube.

Make sure that the o-rings and stainless steel retaining rings are properly seated on the flow cell tube. Push the base of the flow cell onto the flow cell tube until it is firmly seated. This creates the watertight seal.

Screw the locking ring on to the base by turning it clockwise; do not use a tool and do not overtighten.

Repeat the same steps to reconnect the top of the flow cell to the flow cell tube.

5.20 Storage Cases Packing Options

EXO sondes are built with the most rugged and durable materials to safeguard against the risks of water monitoring. Out of the water, the EXO Hard-Sided Carrying Case provides a secure manner in which to store your EXO equipment for travel or until the next trip into the field. As seen below, the EXO Hard-Case provides the perfect safe storage solution, though we do offer several case options.

EXO1, EXO2 and EXO3 Storage Solutions

Within the heavy-grade plastic frame, protective foam form fits your EXO sondes. Additionally, the handheld and detached sensors rest safely within foam housing. The central portion of the case allows users to securely stow other miscellaneous items. There are two separate versions, one which will hold an EXO1 sonde, and another that holds an EXO2 or EXO3 sonde. Both versions include wheels for your convenience.

It is important to note, however, that with greater durability comes increased size and weight. The dimensions of the EXO Hard-Sided Carrying Case are larger than those of its 6-Series counterpart. Additionally, the new EXO case weighs approximately double that of the 6-Series cloth case.

Our EXO sondes are compatible with both YSI carrying cases however, and users should choose the storage solution that is tailored to their individual circumstances. In terms of carrying capacity, both cases are unable to hold multiple EXO2 or EXO3 sondes, and the cloth YSI case can hold up to two EXO1 sondes. Thus, EXO1 users may find it advantageous to utilize that storage option.

While the EXO case is designed exclusively for EXO sondes and equipment, the cloth YSI case was originally intended for use with the 6-Series product line. It is important to note that the cloth case is versatile in nature - allowing users the ability to configure their own storage structure with its Velcro lining and interlocking padded strips. This flexibility enables both EXO1 & EXO2 or EXO3 equipment to fit inside using configurations as seen in the photos.



EXO Hard-Sided Wheeled Carrying Case
#599020-01 (EXO1) and #599020-02 (EXO2 / EXO3)

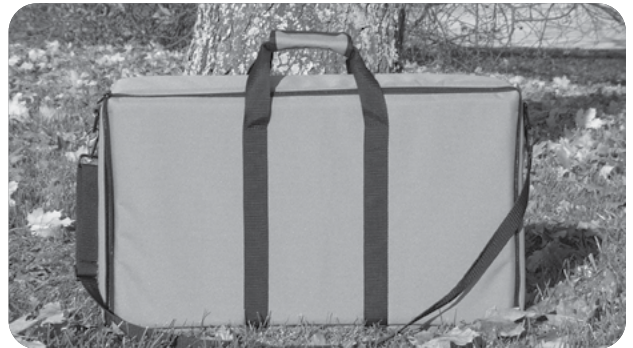

#696162 - 6-Series Soft-Sided Carrying Case



EXO1 configuration, Soft-Sided Case



EXO2 configuration, Soft-Sided Case

Ultimately, while the EXO equipment is built to withstand harsh field environments, we recommend users take care to safely store their systems while not in use. Both the EXO Hard-Sided Carrying Case and the cloth YSI case are viable options, but other non-YSI products may better suit more specialized user needs. (See Appendix below for more information.)



Item Description	Part #'s
EXO1 Wheeled Carrying Case	#599020-01
EXO2 or EXO3 Wheeled Carrying Case	#599020-02

Item Description	Part #
6-Series Carrying Case, Soft-Sided (EXO1, EXO2 or EXO3 Sonde and equipment)	#696162

Appendix: Pelican Cases

Pelican storage cases are another option for EXO users. This third party storage solution is an option for those that prefer to create their own cases for specific purposes. Two Pelican models work the best for storing EXO equipment, the Pelican 1600 and 1700. These cases can be purchased online through a number of portals but do require the user to personally customize the foam interior to fit our sondes and equipment.

Pelican-1600



Pelican-1700





Section 6

Vented Level Sonde

6.1

Vented Level Sonde

Overview

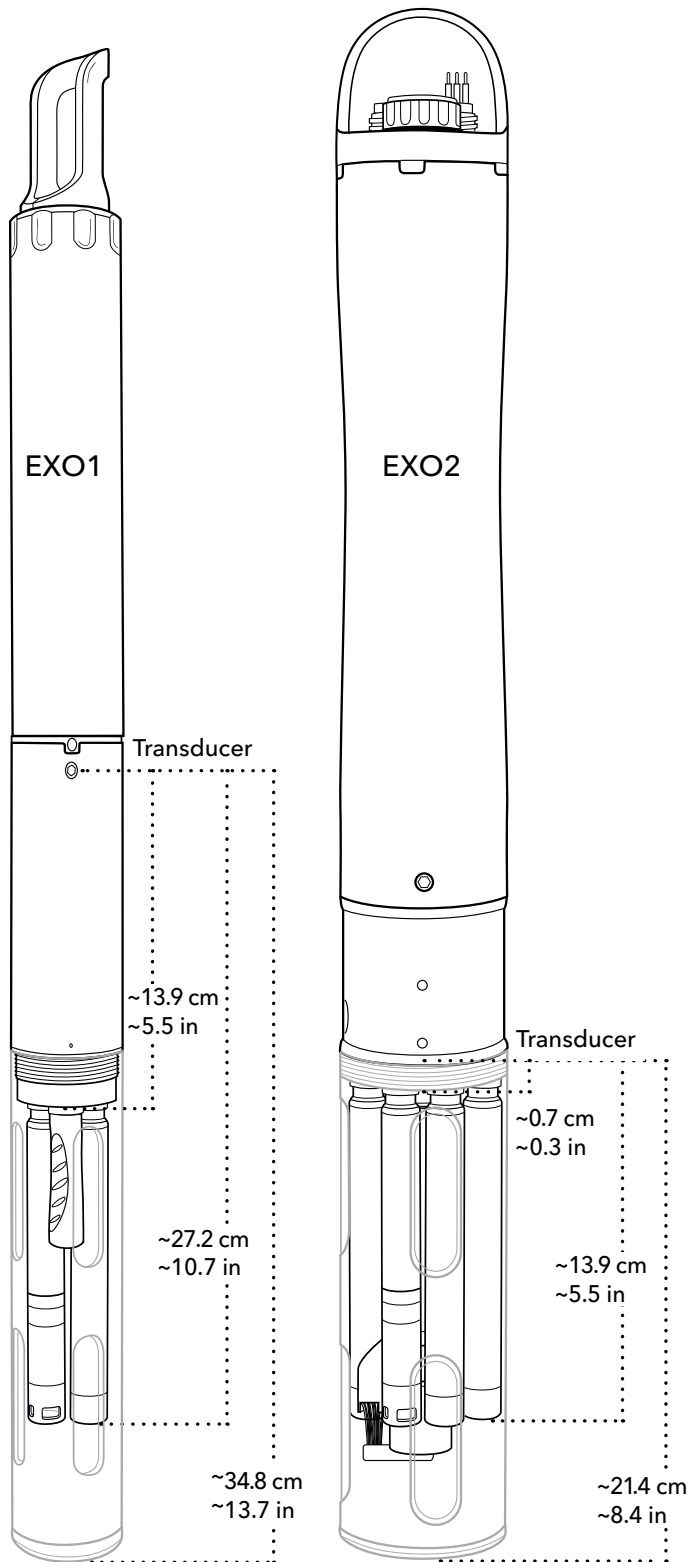

NOTE: EXO3 sondes do not come equipped with a vented level option.

Like EXO depth sensors, level sensors use a differential transducer with one side exposed to the water. However, unlike the depth sensors which have their back side sealed in a vacuum, the other side of the level transducer is vented to the atmosphere.

Because of this venting to the surface the transducer will only measure the water pressure exerted by the water column. Thus, the vented level option for depth measurement eliminates errors due to changes in barometric pressure because the barometric pressure is being seen on both sides of the pressure sensor. This is accomplished by using a special sensor that has been vented to the outside atmosphere by way of a tube that runs through the sonde and cable. This tube must remain open and vented to the outside atmosphere to function. No foreign objects can block the openings.

NOTICE: Never expose the sonde or the cable to the atmosphere for more than a few minutes without an active desiccant or connector dummy plug in place. Moisture or high humidity air entering the vent tubes can condense and block the tube, affecting accuracy; it could also cause damage to the transducer that is not covered by the warranty.

Special field cables are required for vented level measurements. These cables have a vent tube running through the center and connect to the EXO sonde at the connector near the bail. In the center of the sonde's connector is a matching vent hole. When attached, the vented cable allows the sonde to vent through the water column and thus gain a more accurate depth measurement.

6.2

Vented Level Sonde Installation

When installing a vented level sonde, users must ensure that the sonde never exceeds an operational depth of 10 meters. Provisions for floods, astronomical tides and severe storm events should be factored in.

NOTICE: Exposing the depth sensor to depths greater than 10 meters could result in damage to the pressure sensor that is not covered by the warranty.

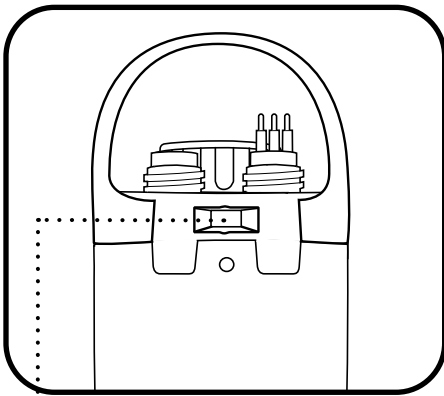

Indentation for location or positioning pin to ensure consistent horizontal orientation

Location of Depth Sensor

For best measurement accuracy when installing a sonde, the sonde's orientation and position must remain fixed.

When deploying the sonde vertically, take care to ensure the sonde is redeployed in the same position. Use a location pin or suspend the sonde using materials that cannot stretch (chain, wire rope) to ensure a fixed location.

Depth sensors on the EXO2 sondes are not on center. In horizontal deployments, take care to ensure the redeployments are always in the same orientation.

To assist with consistent horizontal orientation, the EXO2 sonde has an indentation at the top of the sonde for a location or positioning pin.

NOTICE: Never band clamp a sonde. This can lead to the sonde body becoming warped and taking on water.

EXO1 Depth Sensor Reference Points (see diagram in [Section 6.1](#))

- From bottom of sensor guard (metal or plastic) to transducer diaphragm: ~34.8 cm / ~13.7 inches
- From face of sensor endcap to transducer diaphragm: ~27.2 cm / ~10.7 inches
- From face of connector bulkhead to transducer diaphragm: ~13.9 cm / ~5.5 inches

EXO2 Depth Sensor Reference Points (see diagram in [Section 6.1](#))

- From bottom of sensor guard (plastic or metal) to transducer diaphragm: ~21.4 cm / ~8.4 inches
- From face of sensor endcap to transducer diaphragm: ~13.9 cm / ~5.5 inches
- From face of connector bulkhead to transducer diaphragm: ~0.7 cm / ~0.3 inches
- Horizontally positioned sonde, from outer case (location pin down) to transducer diaphragm: ~2.1 cm / ~0.8 inches

Ambient Light Interference

When deploying horizontally, it is best to keep the sonde's optical sensors out of direct sunlight. We suggest:

- Installing the sonde in a PVC pipe that has adequate openings for flow
- Aiming the sensors north in northern hemisphere or south in southern hemisphere
- Using a sun shield if the sonde is in the open

6.3

Vented Cables and Desiccants

Installation

Cables

Vented cables for EXO have a maximum length of 33 meters, so when connecting a sonde to a data logger, users should use a junction box to reach further distances. In the junction box, the EXO cable can connect to the desiccant, as well as another cable running to the data logger or DCP device.

- Avoid bending vented cables sharply to prevent the inner tube from kinking. (Min. bend radius 20.3 cm/8 in.)
- EXO vented cables have a reduced length to prevent tube damage from their own weight.
- EXO vented cables **do not** have wet-mate connectors—any water or humidity entering the vent tube will cause damage to the pressure sensor that is not covered by the warranty.
- EXO vented cables are not equipped with the barbed fitting for small desiccant cartridges.

Desiccants

NOTICE: All EXO sondes with vented level require the use of a desiccant. Any damage to the sensor due to the lack of desiccant use is not covered under warranty.

Two desiccant systems are available, a cartridge kit (YSI 6108) and a canister kit (YSI 6109). *For all EXO sondes we strongly recommend the 6109 canister kit.* The 6109 desiccant canister contains a larger amount of desiccant and is intended for long-term deployments (can last up to 1 year in severe conditions). It also contains mounting brackets for mounting the canister to a nearby structure. The smaller 6108 kit requires replacement frequently in high humidity environments.

NOTICE: A desiccant or a connector dummy plug must always be attached to the sonde and cable to prevent moisture from entering into the vent tubes.

Users must also ensure that the desiccant always remains active. Active desiccant is a blue color, and when it can absorb no more moisture, it is a pink color. The end that is vented to the atmosphere will begin to change color first. As long as the desiccant closest to the sonde is blue, no maintenance is required. Local conditions will dictate how long the desiccant will last. In humid environments, the desiccant may need to be changed or regenerated before it is completely exhausted to ensure that it lasts the entire deployment.

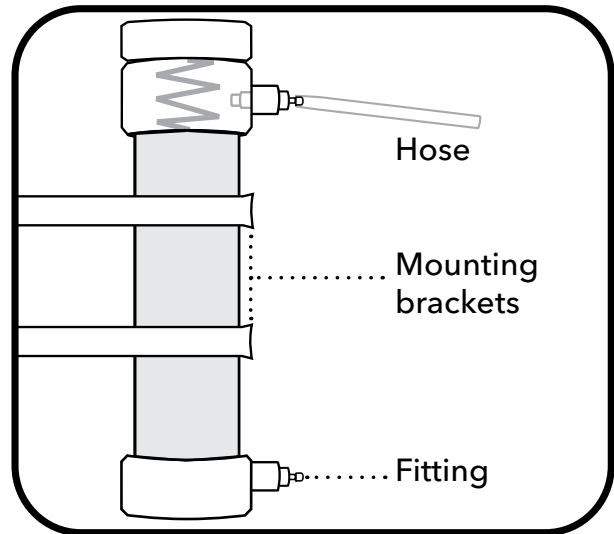

Installing YSI 6109 Desiccant Canister

- Remove the 1/8" NPT plugs from the stainless steel fittings on the canister.
- Install the 1/8" NPT to 1/8" hose fittings into the stainless steel fittings located on the side of the desiccant canister. Do not over-tighten.
- Place the plugs over the fittings on the canister until you are ready to use the canister.
- Using suitable screws fasten the canister mounting brackets to an appropriate support structure. The spacing between the brackets must accommodate the length of the canister. The canister must be located within a few feet of the cable end.
- Remove the plug from the top fitting of the canister. Remove the plug from the barbed fitting on the end of the cable. Using the tubing provided in the kit, connect the canister to the fitting on the end of the cable. Remember to remove the remaining plug from the canister when ready to begin sampling. When putting the sonde into service, remove the plug to ensure that the sensor in the sonde is vented to the atmosphere.

6.4 Calibration

NOTE: This calibration option is available only if your sonde is equipped with a vented level sensor.

For the calibration, make certain that the vented level sensor is in air and not immersed in any solution. Orient the sonde in the same position as it will be deployed. Also, never calibrate a vented level depth sensor with a non-vented cable.



In the desktop KorEXO Calibrate menu, select Depth, then select Depth m to calibrate.

NOTE: If a depth offset is entered, the output value will shift by the value of the offset. Users may use an offset if referencing a water elevation against a known datum.

Observe the Pre Calibration Value readings and the Data Stability, and when they are Stable, click Apply to accept this calibration point. This process zeros the depth sensor.

Click Exit to return to the sensor calibration menu.

For best performance of vented level measurements, users should ensure that the orientation of the sonde remains constant while taking readings. Keep the sonde still and in one position while calibrating.

Advanced

Configure Depth Settings by selecting the Depth Sensor under the Instrument and Sensors menu.



Mounting: Use the Advanced menu to select if a sonde will be mounted in a moving/profiling deployment instead of a fixed location.

Depth Offset: Enter a value in meters (m) to offset the depth at the point of measurement.

Altitude/Latitude: Enter the coordinates for the local altitude (in meters, relative to sea level) and latitude (in degrees) where the sonde is sampling. Latitude values are used in the calculation of depth and level to account for global variations in the gravitational field.

NOTE: You must be within 500 feet (152.4 meters) and 1 degree, respectively.

6.5

Maintenance and Storage

Short-term Storage

NOTICE: It is important that the air in a sonde's vent tube remains dry at all times.

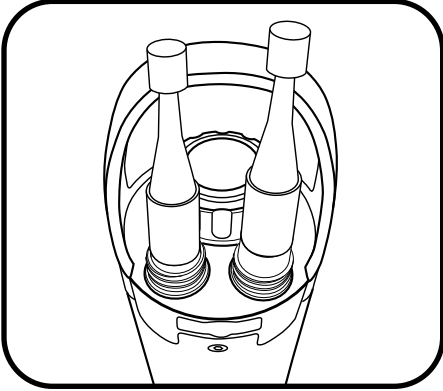

Level Sensor Storage

Users can store these sensors either dry or submerged in clean water. However, regardless of storage method or length, ensure the vent tube remains dry. Always attach the port plug to the cable connector, or leave the cable installed with a cap over the desiccant's vent.

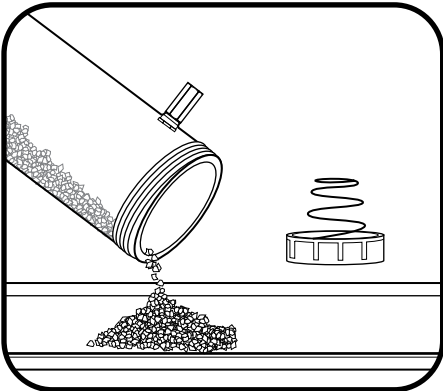

Level Desiccant Maintenance

Active desiccant is blue; saturated desiccant is pink or rose red. When the desiccant closest to the sonde begins to turn pink, you should replace (YSI 6108), or regenerate (YSI 6109) the desiccant cartridge.

To regenerate desiccant, remove it from the cartridge and heat it for one hour at 200°C (about 400°F); then cool it in an airtight container before refilling. Also heat the felt filters at 100°C (about 200°F) for 30 minutes. The desiccant will turn blue following a successful recharge.

Connectors Maintenance

Connectors on vented level cables have five pins and a vent pin. Periodically inspect the connectors for signs of contamination. If you detect debris, carefully remove it. Prior to initial installation, or when dry, apply a *light* coat of Krytox grease to the rubber mating surfaces of the connector (including the rubber portions of the pins).

NOTICE: Do not allow grease to enter or block the vent tube on the cable connector or the vent opening on the sonde connector.

When not in use, always install the sonde and cable dummy plugs.

Cable Storage

Users should leave the cable installed on the sonde to protect the connectors. If necessary users may remove it from the sonde, but extra care should be taken to protect the connectors. For vented cables, ensure the storage cap is affixed to the desiccant inlet. Store vented cables in a bag containing desiccant.

NOTE: *Minimum bend radius for coiling cable is 8 inches (20.32 cm).*



Section 7

Accessories

7.1

Accessories Ordering

Telephone: 800 897 4151 (USA)
+1 937 767 7241 (Globally) Monday through Friday, 8:00
AM to 5:00 ET
Fax: +1 937 767 9353 (orders)
Email: info@ysi.com
Mail: YSI Incorporated 1725 Brannum Lane
Yellow Springs, OH 45387 USA
YSI.com

When placing an order please have the following available:

1. YSI account number (if available)
2. Name and phone number
3. Purchase Order or Credit Card number
4. Model Number or brief description
5. Billing and shipping addresses
6. Quantity

EXO1 Sondes

YSI Item #	Description
599501-00	EXO1 Sonde, No Depth, 4 Sensor Ports
599501-01	EXO1 Sonde, 10 meter Depth, 4 Sensor Ports
599501-02	EXO1 Sonde, 100 meter Depth, 4 Sensor Ports
599501-03	EXO1 Sonde, 250 meter depth, 4 Sensor Ports
599501-04	EXO1 Sonde, 10 meter vented level depth, 4 Sensor Ports

EXO2 Sondes

YSI Item #	Description
599502-00	EXO2 Sonde, No Depth, 6 Sensor Ports, 1 Wiper Port
599502-01	EXO2 Sonde, 10 meter depth, 6 Sensor Ports, 1 Wiper Port
599502-02	EXO2 Sonde, 100 meter depth, 6 Sensor Ports, 1 Wiper Port
599502-03	EXO2 Sonde, 250 meter depth, 6 Sensor Ports, 1 Wiper Port
599502-04	EXO2 Sonde, 10 meter vented level depth, 6 Sensor Ports, 1 Wiper Port

EXO3 Sondes

YSI Item #	Description
599503-00	EXO3 Sonde, No Depth, 4 Sensor Ports, 1 Wiper Port
599503-01	EXO3 Sonde, 10 meter depth, 4 Sensor Ports, 1 Wiper Port
599503-02	EXO3 Sonde, 100 meter depth, 4 Sensor Ports, 1 Wiper Port
599503-03	EXO3 Sonde, 250 meter depth, 4 Sensor Ports, 1 Wiper Port

EXO Handheld

YSI Item #	Description
599960	EXO Handheld (v2) Display

EXO Signal Output Adapters

YSI Item #	Description
599820	EXO Signal Output Adapter - Data Collection Platform (DCP) 2.0
599825	EXO Signal Output Adapter - Modbus
599810	EXO Signal Output Adapter - USB (Necessary for firmware updates.)

EXO Cables

YSI Item #	Description
599040-2	EXO 2 meter Field Cable
599040-4	EXO 4 meter Field Cable
599040-10	EXO 10 meter Field Cable
599040-15	EXO 15 meter Field Cable
599040-33	EXO 33 meter Field Cable
599040-66	EXO 66 meter Field Cable
599040-100	EXO 100 meter Field Cable
599040-150	EXO 150 meter Field Cable
599040-200	EXO 200 meter Field Cable
599040-250	EXO 250 meter Field Cable
599040-300	EXO 300 meter Field Cable
599008-10	EXO 10 meter Flying Lead Cable
599008-15	EXO 15 meter Flying Lead Cable
599008-33	EXO 33 meter Flying Lead Cable
599008-66	EXO 66 meter Flying Lead Cable
599008-100	EXO 100 meter Flying Lead Cable
599210-4	EXO 4 meter VENTED Flying Lead Cable
599210-10	EXO 10 meter VENTED Flying Lead Cable
599210-15	EXO 15 meter VENTED Flying Lead Cable
599210-33	EXO 33 meter VENTED Flying Lead Cable

EXO Sensors & EXO Central Wiper

YSI Item #	Description	YSI Item #	Description
599870	EXO Conductivity/Temperature Sensor	599709	EXO Nitrate Sensor Assembly, Guarded
599827	EXO Wiped Conductivity/Temperature Sensor	599100-01	EXO Optical DO Sensor
577601	EXO pH Sensor Assembly, Guarded	599101-01	EXO Turbidity Sensor
577611	EXO pH/ORP Sensor Assembly, Guarded	599102-01	EXO Total Algae - PC Sensor
577602	EXO pH Sensor Assembly, Unguarded	599103-01	EXO Total Algae - PE Sensor
577612	EXO pH/ORP Sensor Assembly, Unguarded	599104-01	EXO fDOM Sensor
599710	EXO Ammonium Sensor Assembly, Guarded	577614	EXO Rhodamine Sensor
599711	EXO Chloride Sensor Assembly, Guarded	599090-01	EXO Central Wiper

EXO Replaceable Sensor Tips

YSI Item #	Description
577603-01	EXO pH Sensor Replacement Module, Guarded (User replaceable tip for 577601)
577603-02	EXO pH Sensor Replacement Module, Un-Guarded (User replaceable tip for 577602)
577613-01	EXO pH/ORP Sensor Replacement Module, Guarded (User replaceable tip for 577611)
577613-02	EXO pH/ORP Sensor Replacement Module, Un-Guarded (User replaceable tip for 577612)
599744-01	EXO Ammonium Sensor Replacement Module, Guarded (User replaceable tip for 599710)
599743-01	EXO Nitrate Sensor Replacement Module, Guarded (User replaceable tip for 599709)
599745-01	EXO Chloride Sensor Replacement Module, Guarded (User replaceable tip for 599711)

EXO General Accessories

YSI Item #	Description	YSI Item #	Description
599020-01	EXO1 Wheeled Carrying Case, Black	599110	DO Sensor Cap Replacement Kit
599020-02	EXO2 / EXO3 Wheeled Carrying Case, Black	599595	EXO Coastal Anode Kit
599470	EXO C/T Sensor Cleaning Brush	599520	EXO1 Coastal Anode Guard Weight Kit
599831	EXO Wiped C/T Sensor, Spacing Kit	599521	EXO2 Coastal Anode Guard Weight Kit
599080	EXO1 Flow Cell	599338	KorEXO User Interface Software USB
599201	EXO2 / EXO3 Flow Cell	599668	EXO Sensor Retaining Nut Kit, Sensors
599786	EXO1 Calibration/Storage Cup	599669	EXO Sensor Retaining Nut Kit, Wiper
599316	EXO2 / EXO3 Calibration / Storage Cup	599666	EXO1 Guard Assembly Kit
599471	EXO1 Sonde Weight Kit	599667	EXO2 / EXO3 Guard Assembly Kit
599472	EXO2 / EXO3 Sonde Weight Kit	599673	EXO Central Wiper Brush Kit
599473	EXO1 Replacement Bail	599665	EXO Replacement 6-pin Female Dummy Plug
599474	EXO2 / EXO3 Replacement Bail	599664	EXO Replacement 6-pin Male Dummy Plug
599475	EXO 4-Pin Bulkhead Connector Port Plug	599676	EXO Wiper Brush Guard replacement Kit
599594	EXO Tool Kit	599469	EXO Sensor tool and magnet activation kit
599680	EXO1 Replacement O-Ring Kit	599352	Krytox Lubricant
599681	EXO2 / EXO3 Replacement O-Ring Kit	006109	Desiccant Canister Kit
599677	EXO Sensor O-Ring Kit	006108	Desiccant Cartridge Kit

EXO Antifouling Accessories

YSI Item #	Description
599867	EXO Anti Fouling C/T Screen
599563	EXO1 Anti-Fouling Guard
599564	EXO2 / EXO3 Anti-Fouling Guard
599663	EXO2 / EXO3 Probe and Sonde protective sleeves
6189-AF	Copper tape kit
C-SPRAY	Protective probe solution, 100 mL bottle

Calibration Standards and Solutions

YSI Item #	Description	YSI Item #	Description
065270	Conductivity Cal. - 1,000 umhos/cm (quart)	003821	pH 4 Buffer - Box of 6 pints
065272	Conductivity Cal. - 10,000 umhos/cm (quart)	003822	pH 7 Buffer - Box of 6 pints
065274	Conductivity Cal. - 100,000 umhos/cm (quart)	003823	pH 10 Buffer - Box of 6 pints
060907	Conductivity Cal. - 1,000 umhos/cm (8 ea, pint)	603824	Assorted pH Buffers - 2 pints of 4 - 2 pints of 7 - 2 pints of 10"
060911	Conductivity Cal. - 10,000 umhos/cm (8 ea, pint)	003841	Ammonium Cal Solution - 1 mg/L (500mL)
060660	Conductivity Cal. - 50,000 umhos/cm (8 ea, pint)	003842	Ammonium Cal Solution - 10 mg/L (500mL)
061320	Zobell Solution - For ORP cal. - 125 mL	003843	Ammonium Cal Solution - 100 mg/L (500mL)
061321	Zobell Solution - For ORP cal. - 250 mL	003885	Nitrate Standard - 1 mg/L (500mL)
061322	Zobell Solution - For ORP cal. - 500 mL	003886	Nitrate Standard - 10 mg/L (500mL)
		003887	Nitrate Standard - 100 mg/L (500mL)
		608000	Turbidity Std. - 0 NFU, 0 NTU - 1 Gallon
		607200	Turbidity Std. - 12.4 FNU - 1 Gallon
		607300	Turbidity Std. - 124 FNU - 1 Gallon
		607400	Turbidity Std. - 1010 FNU - 1 Gallon

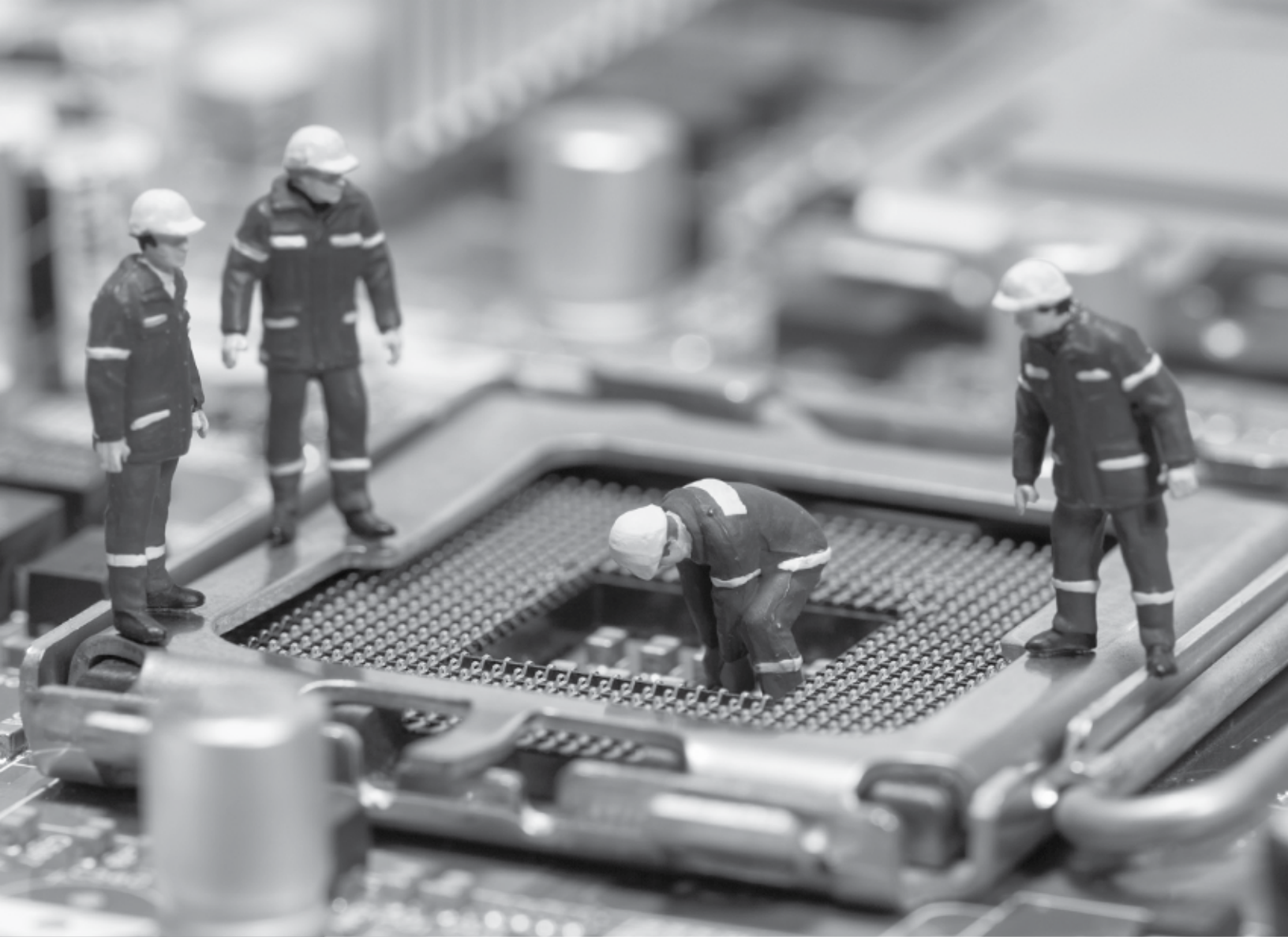

Section 8

Health and Safety, Warranty, Service

8.1

Health and Safety

Chemicals

NOTE: For additional health, safety, and disposal information about reagents, download the MSDS documents for the chemical in question from the EXO manufacturers' websites: www.ysi.com or www.wtw.de.

First Aid for all solutions

Inhalation	Move to fresh air. If breathing is difficult, give oxygen. If symptoms persist, seek medical attention.
Skin Contact	Remove contaminated clothing and wash. Wash exposed area with soap and water for at least 15 minutes. If irritation persists, seek medical attention.
Eye Contact	Rinse eyes immediately with large amounts of water, also under eyelids, for at least 15 minutes. If irritation persists, seek medical attention.
Ingestion	Wash out mouth with water and then drink plenty of water. If symptoms persist, seek medical attention.

Ammonium Solutions

3841, 3842, and 3843

Ingredients: Water, Ammonium Chloride, Lithium Acetate Dihydrate, Sodium Azide, Hydrochloric Acid

Nitrate Solutions

3885, 3886, and 3887

Ingredients: Water, Potassium Nitrate, Magnesium Sulfate Heptahydrate, Gentamycin Sulfate

Inhalation: Avoid breathing vapors or mists. Ensure adequate ventilation is available before handling.

Skin: Wear lightweight protective clothing, gloves, and apron.

Eyes: Wear safety glasses with side-shields or face shield. Contact lenses should not be worn when working with these solutions.

Ingestion: May be harmful if swallowed. Wear a mouth cover or face shield when there is splashing. Keep away from food and drink.

First Aid: See box at left.

Conductivity Solutions

3161, 3163, 3165, 3167, 3168, and 3169

Ingredients: Water, Potassium Chloride

Inhalation: Avoid breathing vapors or mists. Inhalation of dust may cause irritation of respiratory tissues. Ensure adequate ventilation is available before handling.

Skin: Exposure may cause irritation with repeated exposure. Wear lightweight protective clothing, gloves, boots, and apron.

Eyes: Can cause irritation and potential eye damage with repeated exposure. Wear safety glasses with side-shields or face shield.

Ingestion: May cause irritation of mouth, throat, and an upset stomach. Wear a mouth cover or face shield when there is splashing. Keep away from food and drink. Do not swallow.

First Aid: See box at left.

pH 4.00, 7.00, 10.00 Buffer Solutions

3821, 3822, and 3823

pH 4 Ingredients: Water, Potassium Hydrogen Phthalate, Red food coloring

pH 7 Ingredients: Water, Potassium Phosphate Monobasic, Sodium Hydroxide, Yellow food coloring

pH 10 Ingredients: Water, Potassium Hydroxide, Disodium EDTA dihydrate, Potassium Borate, Potassium Carbonate, Bromphenol Blue Sodium Salt, Bromphenol Green Sodium Salt

Inhalation: Avoid breathing vapors or mists. Inhalation of dust may cause irritation of respiratory tissues. Ensure adequate ventilation is available before handling.

Skin: Exposure may cause irritation with repeated exposure. Wear rubber or neoprene gloves.

Eyes: Can cause irritation and potential eye damage with repeated exposure. Wear safety glasses with side-shields or face shield. Contact lenses should not be worn when working with these solutions.

Ingestion: May cause nausea, vomiting, or diarrhea. Wear a mouth cover or face shield when there is splashing. Do not swallow. Do not induce vomiting.

First Aid: See [First Aid](#) table.

Zobell Solution

3682

Ingredients: Potassium Chloride, Potassium Ferrocyanide Trihydrate, Potassium Ferricyanide

Inhalation: Inhalation of dust may cause irritation of respiratory tissues. Ensure adequate ventilation is available before handling.

Skin: Exposure may cause irritation. Wear lightweight protective clothing, gloves, boots, and apron.

Eyes: May cause irritation. Wear safety glasses with side-shields or face shield.

Ingestion: May cause an upset stomach. Wear a mouth cover or face shield when there is splashing. Keep away from food and drink. Do not swallow. If large amount is ingested and person is conscious, induce vomiting.

First Aid: See [First Aid](#) table.

Turbidity Standard

6073

Ingredients: Water, Styrene divinyl Benzene copolymer beads

The material is not volatile and has no known ill effects on skin, eyes, inhalation or ingestion. Therefore, no special precautions are required when using the standards. However, general precautions should be adopted as required with all materials to minimize unnecessary contact.

First Aid: See [First Aid](#) table.

Ultraviolet Light

The fDOM sensor radiates ultraviolet light (UV light) which can be harmful to the eyes even during brief periods of exposure. Do not look into the light at the tip of the probe and wear protective eyewear when handling UV LEDs.

Lithium-Ion Battery Handling



WARNING: Failure to exercise care when handling this product and to comply with the following conditions and guidelines could result in product malfunction, excessive heat, fire, property damage, and ultimately injury.

- **DO NOT** alter, puncture, or impact battery or related components.
- **DO NOT** directly connect the terminals with metal objects.
- **DO NOT** expose the battery to extreme temperatures or direct extended exposure to sunlight.
- Always disconnect batteries when not in use and for long term storage.
- Store batteries in a non-conductive and fireproof container.
- For best results, store the battery at approximately 50% of the capacity.

If at any time the battery becomes damaged, hot, or begins to balloon or swell, discontinue charging (or discharging) immediately. Quickly and safely disconnect the charger. Then place the battery and/or charger in a safe, open area way from flammable materials. After one hour of observation, remove the battery from service. **DO NOT** continue to handle, attempt to use, or ship the battery. Failure to follow these procedures can cause damage to the battery, personal property or cause serious injury.

Damaged or swollen batteries can be unstable and very hot. **DO NOT** touch batteries until they have cooled. In the event of a fire use a Class A, B, or C fire extinguisher. **DO NOT** use water.

If the internal battery fluid comes into contact with your skin, wash the affected area(s) with soap and water immediately. If it comes into contact with your eye(s), flush them with generous amounts of water for 15 minutes and seek immediate medical attention.

8.2

Radio Frequency

Xylem certifies that the EXO product line has been tested and complies with the following radio frequency (RF) interference standards and are approved for use in the following countries:

- United States: FCC Part 15 compliant
- Canada: RSS compliant
- European Union (EU): CE compliant
- Australia: CISPR 11 compliant
- New Zealand: CISPR 11 compliant
- Republic of Korea: Radio Waves Act compliant
- Japan: TELEC Radio Law compliant
- Brazil: Anatel certification compliant

Reference the Declaration of Conformity in the next section for further details.

 [®] *Bluetooth* wireless technology and similar approvals and regulations can be country-specific. Check local laws and regulations to insure that the use of wireless products purchased from Xylem or its subsidiaries are in full compliance.

8.3

Declarations of Conformity

The undersigned hereby declares that the products listed below conform with all applicable requirements of FCC Part 15 for the U.S. and Industry Canada (IC) ICES-003 for Canada.

Manufacturer: YSI Incorporated, a Xylem brand
1725 Brannum Lane
Yellow Springs, OH 45387 USA

Equipment name: EXO Sondes (EXO1, EXO2 and EXO3), EXO Handheld (V2) and EXO GO

Model numbers: 599501-xx, 599502-xx, 599503-xx, 599960, 577400

Intentional Radiators: EXO Sondes (EXO1, EXO2 and EXO3) contain a *Bluetooth* module:



FCC ID: T7VPAN10

IC: 216Q-PAN10

EXO GO contains a *Wi-Fi/Bluetooth* module:

FCC ID: T9J-RN42

IC: 6514A-RN42

Regulations:

- FCC 47 CFR Part 15
- IC ICES-003

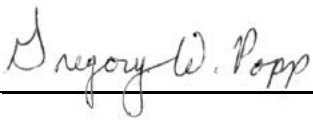

Gregory Popp, Quality Manager
January 14th, 2019

The undersigned hereby declares that the products listed below conform with all applicable Essential Requirements of the listed Directives and Standards and carry the CE mark accordingly.

Manufacturer: YSI Incorporated, a Xylem brand
1725 Brannum Lane
Yellow Springs, OH 45387 USA

Equipment name: EXO Sondes (EXO1, EXO2 and EXO3), EXO Handheld (v2) and EXO GO
Model numbers: 599501-xx, 599502-xx, 599503-xx, 599960, 577400

Accessories/Sensors: 599090-xx, 599100-xx, 599101-xx, 599102-xx, 599104-xx, 599118-xx, 599800,
599810, 599870, 599040-xx, 599008-xx, 577641

Intentional Radiators: EXO Sondes (EXO1, EXO2 and EXO3) contain a *Bluetooth* module.
 The EXO GO (577400) contains a *Bluetooth* module.
Nemko Certified Body ID#CE 2302.

Directives:

- EMC 2014/30/EU
- RED 2014/53/EU
- LVD 2014/35/EU
- R&TTE 1999/5/EC
- WEEE 2012/19/EU
- RoHS 2011/65/EU

Harmonized Standards:

- EN61326-1:2013, Electrical equipment for measurement, control and laboratory use - EMC requirements - Part 1: General requirements
- EN 61326-2-3:2013, Electrical equipment for measurement, control and laboratory use - EMC requirements - Part 2-3: Particular requirements - Test configuration, operational conditions and performance criteria for transducers with integrated or remote signal conditioning
- EN 60950-1:2006 + A11:2009 + A12:2011 + A1:2010 + A2:2013, Information technology equipment - Safety - Part 1: General requirements
- EN 300 328 V2.1.1:2017, Wideband transmission systems; Data transmission equipment operating in the 2,4 GHz ISM band and using wide band modulation techniques; Harmonised Standard covering the essential requirements of article 3.2 of Directive 2014/53/EU
- EN 301 489-1 V1.9.2:2011, Electromagnetic compatibility and Radio spectrum Matters (ERM); Electromagnetic Compatibility (EMC) standard for radio equipment and services; Part 1: Common technical requirements
- EN 301 489-17:2009, V2.1.1, Electromagnetic compatibility and Radio spectrum Matters (ERM); Electromagnetic Compatibility (EMC) standard for radio equipment; Part 17: Specific conditions for Broadband Data Transmission Systems
- EN61000-3-2:2014, Electromagnetic compatibility (EMC) - Part 3-2: Limits - Limits for harmonic current emissions (equipment input current ≤ 16 A per phase)
- EN61000-3-3:2013, Electromagnetic compatibility (EMC) - Part 3-3: Limits - Limitation of voltage changes, voltage fluctuations and flicker in public low-voltage supply systems, for equipment with rated current ≤ 16 A per phase and not subject to conditional connection

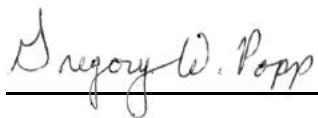

Gregory Popp, Quality Manager
January 14th, 2019

The undersigned hereby declares that the products listed below conform with the Australian and New Zealand Electromagnetic Compatibility (EMC) requirements for generic products to be used in residential, commercial, and light industrial environments, and carry the C-Tick mark accordingly.

Manufacturer: YSI Incorporated, a Xylem brand
1725 Brannum Lane
Yellow Springs, OH 45387 USA

Equipment name: EXO Sondes (EXO1, EXO2 and EXO3), EXO Handheld (v2) and EXO GO
Model numbers: 599501-xx, 599502-xx, 599503-xx, 599960, 577400

Accessories/Sensors: 599090-xx, 599100-xx, 599101-xx, 599102-xx, 599104-xx, 599118-xx, 599800,
599810, 599870, 599040-xx, 599008-xx, 577641

Intentional Radiators: EXO Sondes (EXO1, EXO2 and EXO3) contain a *Bluetooth* module.
 EXO GO (577400) contains a *Bluetooth* module.
Nemko Certified Body ID#CE 2302.

Regulations:

- Australian ACMA Standards for C-Tick mark, Section 182 of the Radiocommunications Act 1992.
- New Zealand RSM Standards, Radiocommunications Act 1992.
- Telecommunications Labeling, Notice 2001 under section 407 of the Australian Telecommunications Act 1997.

Standards:

- EN61326-1:2006, Electrical equipment for measurement, control, and laboratory use - EMC requirements - Part 1: General Requirements.
- ACMA Radio Communications (Short Range Devices), 2004.
- AS/NZ 4268, 2008.
- Radio Communications (Electromagnetic Radiation - Human Exposure) Standard, March 2003.

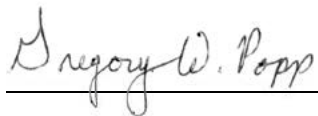

Gregory Popp, Quality Manager
January 14th, 2019

The undersigned hereby declares that the products listed below conform with all applicable requirements of the Radio Waves Act of Korea, for intentional radiators.

Manufacturer: YSI Incorporated, a Xylem brand
1725 Brannum Lane
Yellow Springs, OH 45387 USA

Equipment name: EXO Sondes (EXO1, EXO2 and EXO3) and EXO GO

Model numbers: 599501-xx, 599502-xx, 599503-xx, 577400

Intentional Radiators: EXO Sondes (EXO1, EXO2 and EXO3) contain the PAN1026 *Bluetooth* module.



Broadcasting and certification number R-C-XYL-EXO1 (for EXO1), R-C-XYL-EXO2 (for EXO2) and R-C-XYL-EXO3-PAN1026 (for EXO3).

EXO GO (577400) contains a *Bluetooth* module. Broadcasting and certification number KCC-CRI-AEP-RN-42.

Type Identification: LARN8-IO2Y2402/2480TR0.000003F1D79 (EXO1)

LARN8-IO2Y2402/2480TR0.00001F1D79 (EXO2)

LARN8-IO2Y2402/2480TR0.001F1D79 (EXO3)

LARN8-IO2Y2402/2480TR0.00003F1DG1D79 (EXO Handheld)

Regulation: Radio Waves Act of the Republic of Korea.

A급 기기 (업무용 방송통신기자재)

이 기기는 업무용 (A급) 전자파 적합기기로서
판매자 또는 사용자는 이 점을 주의하시기 바라
며, 가정 외의 지역에서 사용하는 것을 목적으로 합니다.

Class A device (Broadcasting and communication equipment for office work).

Seller and user shall be noticed that this equipment is suitable for electromagnetic equipment for office work (Class A) and it can be used outside the home.

KCC notice 2012-12. Radio device using 2400-2483.5 MHz and 5725-5825 MHz.

해당 무선설비는 전파혼신
가능성이 있으므로 인명안전과
관련된 서비스는 할 수 없음.

Service related to human safety is not allowed because this device may have the possibility of the radio interference.

Gregory Popp, Quality Manager

January 14th, 2019

The undersigned hereby declares that the products listed below conform with all applicable requirements of the Radio Regulations of China, for intentional radiators.

Manufacturer: YSI Incorporated, a Xylem brand
1725 Brannum Lane
Yellow Springs, OH 45387 USA

Equipment name: EXO GO
Model numbers: 577400

Intentional Radiators: The EXO GO (577400) contains a *Bluetooth* module.



CMIIT ID: CMIIT ID: 2018DJ2145 (EXO GO)

Regulation: Radio Regulations of the People's Republic of China.

A级设备（办公用广播和通讯设备）

销售商和使用者应注意本设备适用于办公条件下的电磁环境（A级）并可以在室外使用。

Class A device (Broadcasting and communication equipment for office work).

Seller and user shall be noticed that this equipment is suitable for electromagnetic equipment for office work (Class A) and it can be used outside the home.

A handwritten signature in cursive script that reads "Gregory W. Popp". The signature is written in black ink and is positioned above a horizontal line.

Gregory Popp, Quality Manager
January 14th, 2019

The undersigned hereby declares that the products listed below conform with all applicable requirements of TELEC and Radio Law of Japan for intentional radiators.

Manufacturer: YSI Incorporated, a Xylem brand
1725 Brannum Lane
Yellow Springs, OH 45387 USA

Equipment name: EXO Sondes (EXO1, EXO2 and EXO3) and EXO GO

Model numbers: 599501-xx, 599502-xx, 599503-xx, 577400

Intentional Radiators: EXO Sondes contain transmitter module with certification number:



MIC ID: [R]202-LSE095

EXO GO contains transmitter module with certification number:

MIC ID: [R]201-125709

Regulations: TELEC; Article 38-24 Paragraph 1 of the Radio Law.

A handwritten signature in cursive script that reads "Gregory W. Popp". The signature is written in black ink and is positioned above a horizontal line.

Gregory Popp, Quality Manager

January 14th, 2019

The undersigned hereby declares that the products listed below conform with all applicable requirements of the Anatel Regulations of Brazil for intentional radiators.

Manufacturer: YSI Incorporated, a Xylem brand
1725 Brannum Lane
Yellow Springs, OH 45387 USA

Equipment name: EXO Sondes (EXO1, EXO2 and EXO3) and EXO GO

Model numbers: 599501-xx, 599502-xx, 599503-xx, 577400

Intentional Radiators: Intentional Radiators: EXO Sondes (EXO1, EXO2 and EXO3) contain the
 PAN1026 *Bluetooth* module: Certificate of Homologation No. 01640-18-08838;
Certificate of Conformity No. 00106288.
EXO GO (577400) contains the RN42 *Bluetooth* module:
Certificate of Homologation No. 00436-18-08838;
Certificate of Conformity No. 00099335.

Regulations: Anatel; Transceptor de Radiacao Restrita - Categoria II

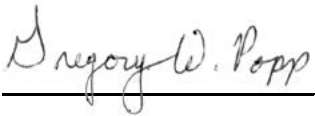

Gregory Popp, Quality Manager
January 14th, 2019

8.4

Instrument Warranty

Warranty Card

Register your product with the online warranty card:
www.YSI.com/warranty

Warranted against defects in workmanship and materials when used for their intended purposes and maintained according to instructions and exclusive of batteries and any damage caused by defective batteries.

Three years: handheld

Two years: cables; sondes (bulkheads); conductivity, temperature, depth, and optical sensors; electronics base for pH, pH/ORP, ammonium, chloride, and nitrate sensors; and accessories

One year: optical DO membranes and replaceable reagent modules for pH and pH/ORP; EXO GO

Three months: replaceable reagent modules for ammonium, chloride, and nitrate

Regular maintenance of sondes and sensors, such as replacing damaged o-rings, is described in the Maintenance section of this manual. Users are expected to follow these guidelines to keep their equipment in good and proper working order and to protect the warranty on the product. Damage due to accidents, misuse, tampering, or failure to perform prescribed maintenance is not covered.

This warranty does not include batteries or damage resulting from defective batteries. As documented in the Maintenance section of this manual, batteries should be removed from all sondes and handheld when the product is not in use. Since many battery manufacturers will repair or replace any equipment that has been damaged by their batteries, it is essential that leaky or defective batteries be retained with the damaged product until the manufacturer has evaluated the claim.

Product(s) must be sold by and received from Xylem or an authorized representative or distributor. The warranty period starts when the instrument is received. The warranty period for chemicals and reagents is determined by the expiration date printed on their labels. Within the warranty period, we will repair or replace, at our sole discretion, free of charge, any product that we determine to be covered by this warranty.

To exercise this warranty, write or call your local representative, or contact Technical Support. Send the product and proof of purchase, transportation prepaid, to the Authorized Service Center selected by the manufacturer. Repair or replacement will be made and the product returned transportation prepaid. Repaired or replaced products are warranted for the balance of the original warranty period, or at least 90 days from date of repair or replacement.

Limitation of Warranty

This Warranty does not apply to any EXO product damage or failure caused by (i) failure to install, operate or use the product in accordance with the written instructions, (ii) abuse or misuse of the product, (iii) failure to maintain the product in accordance with the written instructions or standard industry procedure, (iv) any improper repairs to the product, (v) use by you of defective or improper components or parts in servicing or repairing the product, or (vi) modification of the product in any way not expressly authorized by the manufacturer.

THIS WARRANTY IS IN LIEU OF ALL OTHER WARRANTIES, EXPRESSED OR IMPLIED, INCLUDING ANY WARRANTY OF MERCHANTABILITY OR FITNESS FOR A PARTICULAR PURPOSE. YSI's LIABILITY UNDER THIS WARRANTY IS LIMITED TO REPAIR OR REPLACEMENT OF THE PRODUCT, AND THIS SHALL BE YOUR SOLE AND EXCLUSIVE REMEDY FOR ANY DEFECTIVE PRODUCT COVERED BY THIS WARRANTY. IN NO EVENT SHALL YSI BE LIABLE FOR ANY SPECIAL, INDIRECT, INCIDENTAL OR CONSEQUENTIAL DAMAGES RESULTING FROM ANY DEFECTIVE PRODUCT COVERED BY THIS WARRANTY.

EXO Authorized Service Centers are located in the United States and around the world. Please refer to the YSI website (www.YSI.com/Repair) for your nearest Authorized Service Center.

8.5

Instrument Service

Cleaning and Packing

Product Return Form

Find the product return form online:
www.YSI.com/Repair

Cleaning Certificate

Find the cleaning certificate on the back of the online product return form:
www.YSI.com/Repair

Cleaning Instructions

Before they can be serviced, equipment exposed to biological, radioactive, or toxic materials must be cleaned and disinfected. Biological contamination is presumed for any instrument, probe, or other device that has been used with body fluids or tissues, or with wastewater. Radioactive contamination is presumed for any instrument, probe or other device that has been used near any radioactive source.

If an instrument, probe, or other part is returned or presented for service without a Cleaning Certificate, and if in our opinion it represents a potential biological or radioactive hazard, our service personnel reserve the right to withhold service until appropriate cleaning, decontamination, and certification has been completed. We will contact the sender for instructions as to the disposition of the equipment. Disposition costs will be the senders responsibility.

When service is required, either at the user's facility or at the manufacturer, the following steps must be taken to insure the safety of our service personnel:

- In a manner appropriate to each device, decontaminate all exposed surfaces, including any containers. 70% isopropyl alcohol or a solution of 1/4 cup bleach to 1 gallon tap water are suitable for most disinfecting. Instruments used with wastewater may be disinfected with .5% Lysol® if this is more convenient to the user.
- The user shall take normal precautions to prevent radioactive contamination and must use appropriate decontamination procedures should exposure occur.
- If exposure has occurred, the customer must certify that decontamination has been accomplished and that no radioactivity is detectable by survey equipment.
- Cleaning must be completed and certified on any product before returning.

Packing Instructions

- Clean and decontaminate items to insure the safety of the handler.
- Complete and include the Product Return Form, found online.
- Place the product in a plastic bag to keep out dirt and packing material.
- Use a large carton, preferably the original, and surround the product completely with packing material.

8.6

Instrument Service

Recycling

Batteries

The user must remove and dispose of alkaline batteries when they no longer power the EXO1 sonde, EXO2 sonde, or EXO Hand-held. Disposal requirements vary by country and region, and users are expected to understand and follow the battery disposal requirements for their specific locale.

The circuit board in these instruments may contain a manganese dioxide lithium "coin cell" battery that must be in place for continuity of power to memory devices on the board. This battery is not user serviceable or replaceable. When appropriate, an authorized service center will remove this battery and properly dispose of it, per service and repair policies.

Rechargeable Li-Battery Pack

(1) When the battery is worn out, insulate the terminals with adhesive tape or similar materials before disposal.

(2) Dispose of batteries in the manner required by your city, county, state or country. For details on recycling lithium-ion batteries, please contact a government recycling agency, your waste-disposal service, or visit reputable online recycling sources such as www.batteryrecycling.com.

This product must not be disposed of with other waste. Instead, it is the user's responsibility to dispose of their waste equipment by handing it over to a designated collection point for the recycling of waste electrical and electronic equipment. The separate collection and recycling of your waste equipment at the time of disposal will help to conserve natural resources and ensure that it is recycled in a manner that protects human health and the environment.

For more information about where you can drop off your waste equipment for recycling, please contact your local city office, or your household waste disposal service. **DO NOT ship batteries to YSI.**

Manufacturer

We are committed to reducing the environmental footprint of our products. While materials reduction is the ultimate goal, we also make a concerted effort to responsibly deal with materials after a long, productive life-cycle. Our recycling program ensures that old equipment is processed in an environmentally responsible way, reducing the amount of materials going to landfills.

- Printed circuit boards are sent to facilities that process and reclaim as much material for recycling as possible.
- Plastics enter a material recycling process and are not incinerated or sent to landfills.
- Batteries are removed and sent to battery recyclers for dedicated metals.



Section 9

Appendices

9.1

EXO PAR

User Manual



EXO PAR

PHOTOSYNTHETICALLY ACTIVE RADIATION WITH THE EXO PLATFORM

Introduction

PAR Sensor

Some users of the YSI EXO sonde may wish to incorporate a photosynthetically active radiation (PAR) sensor into their field monitoring equipment. This sensor can be added to the YSI EXO2 sonde in the form of a special adapter engineered by YSI's Integrated System & Services division. This appendix is designed to give potential users of this PAR adapter information on how the system is configured and the steps necessary to acquire and log PAR data with the EXO PAR adapter.

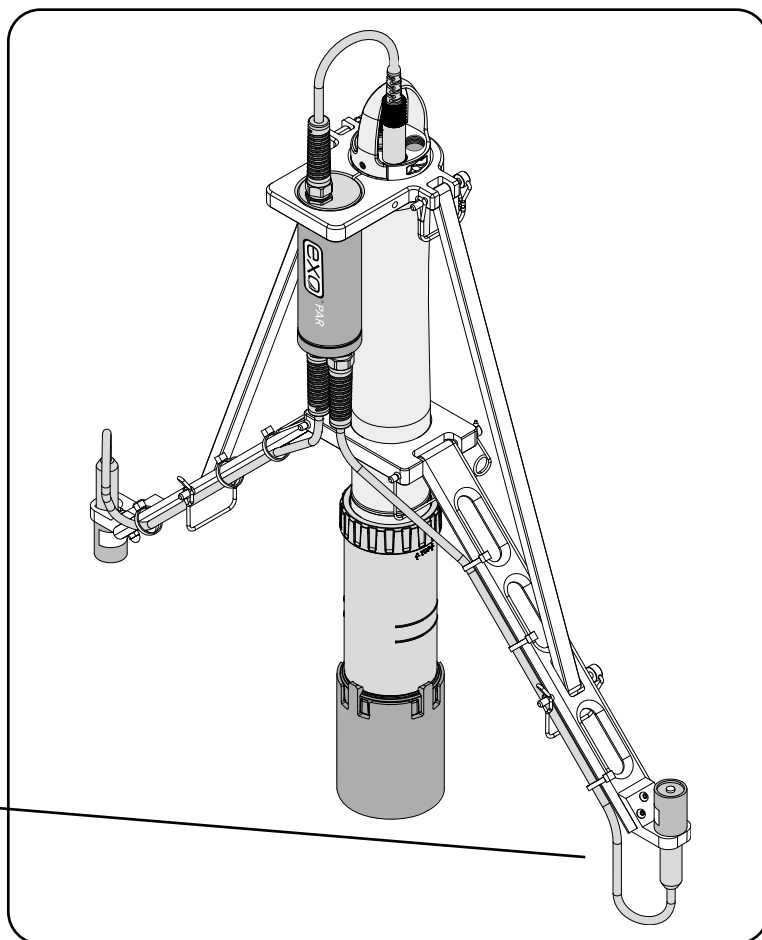
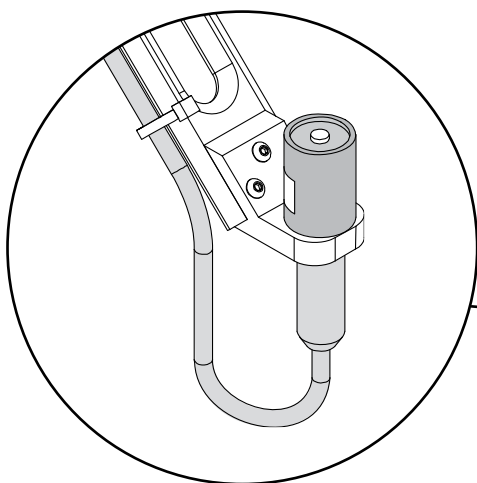

Figure 1 EXO PAR adapter with Sonde

Overview

Li-Cor PAR sensors are required for the EXO PAR adapter and these sensors can either be supplied to YSI by the customer (brass mounting screws provided with the sensor are required for installing on the par system) or can be purchased from YSI as part of the complete system. These sensors are then mounted to arms which extend from the sonde on either side. Output cables are then attached to the sensors which connect to the EXO PAR adapter, which in turn connects to the EXO2 Auxiliary port on the top of the sonde, as show in Figure 1.

Figure 1 shows the installation of two sensors (one pointing up, the other pointing down), but it is also possible to use a single PAR sensor in either an upward or downward looking configuration.

Your EXO PAR system is shipped separate from your EXO2 sonde and can be installed onto the EXO2 sonde following these easy steps.

Components

The EXO PAR Systems consists of 3 main parts: The EXO PAR adapter cylinder and cables, the black plastic frame system and calibration cup extender, and the Li-Cor PAR sensors.

The EXO PAR system attaches to the EXO2 sonde via an upper and lower clamp system. The EXO PAR adapter attaches to the AUX port on the top bulkhead of the EXO2 sonde.

NOTE: In order for the EXO PAR adapter to be recognized, it must be plugged into the AUX port before applying power to the sonde.

For shipment and storage, the EXO PAR system can fold its sensor and support arms in, along the body of the EXO2 sonde (figure 2).

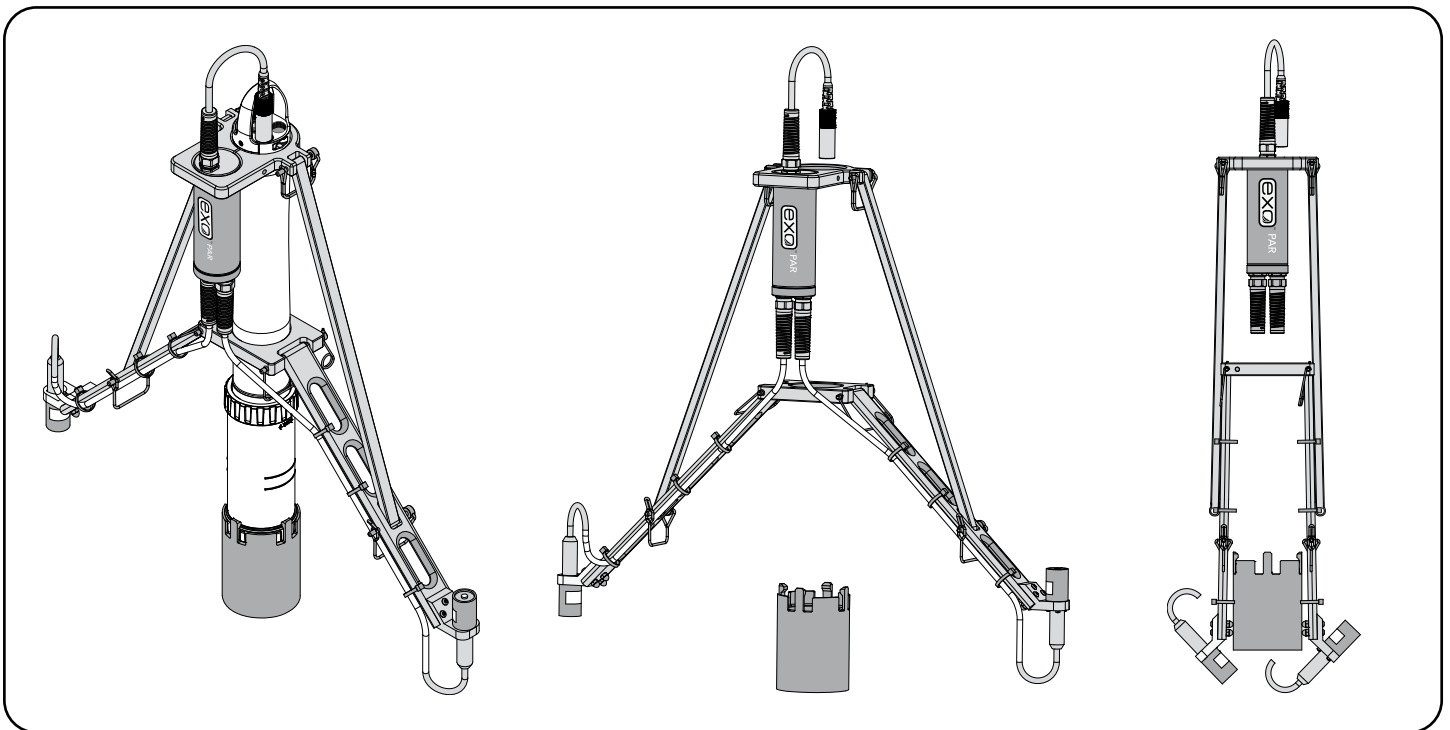

Figure 2 The EXO PAR system attaches to the EXO2 sonde via an upper and lower clamp system

Installation

Attach EXO Calibration Cup Extender

Once you've unpacked the EXO PAR system, attach the EXO calibration cup extender to the bottom of your calibration cup. It simply clicks on by inserting the bottom of the calibration cup into the top of the extender and pushing down on a hard surface (figure 3).

The calibration cup extender provides you the extra height you will need to prevent your PAR sensors and cables from impacting the ground. It's ideal for in lab use but we recommend using a lab stand as well for stability, to prevent your sonde and PAR system from tipping over and potentially causing damage.

⚠ CAUTION: Potential pinch hazard, be mindful of fingers.

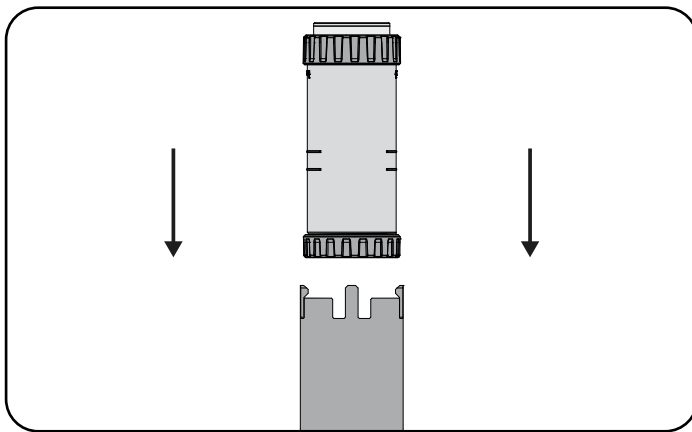

Figure 3 Push down to mate the extender onto the calibration cup.

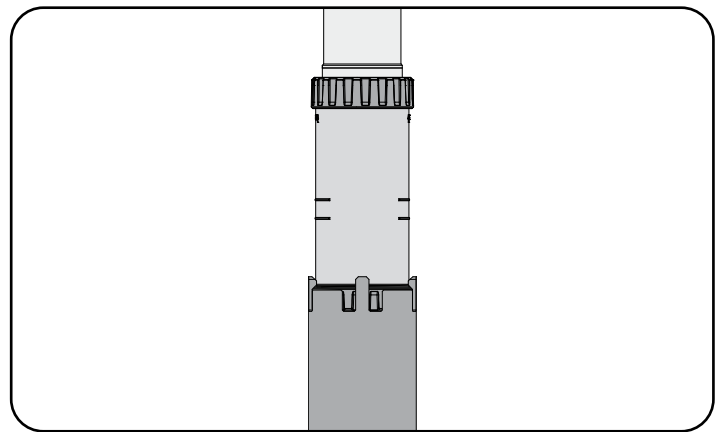

Figure 4 The extender merged with the calibration cup.

Attach the EXO PAR System Frame

Now that your calibration cup extender is installed, stand the sonde in an upright position and slide the EXO PAR system frame over the EXO2 sonde. The two clamps; upper and lower are fastened to the EXO2 sonde body via two, 5/16-18 x 2.75" socket cap bolts. You will need to use a 1/4" Allen wrench to secure these two bolts. Tighten the bolts until the clamp fits snug to the body of the sonde. Proper alignment of these clamps, as described below, should be followed as to not damage either system.

NOTE: Install the EXO PAR system with the EXO PAR adapter cylinder on the same side of the sonde where the AUX port connector is located. You will connect the EXO PAR adapter into this AUX port.

1. The top of the upper clamp should align with the yellow bulkhead of the sonde (where the blue meets the yellow). Proper alignment is necessary so that the PAR sensor arms are deployed at the correct angle.

NOTICE: Proper alignment of clamps is necessary to prevent damage.

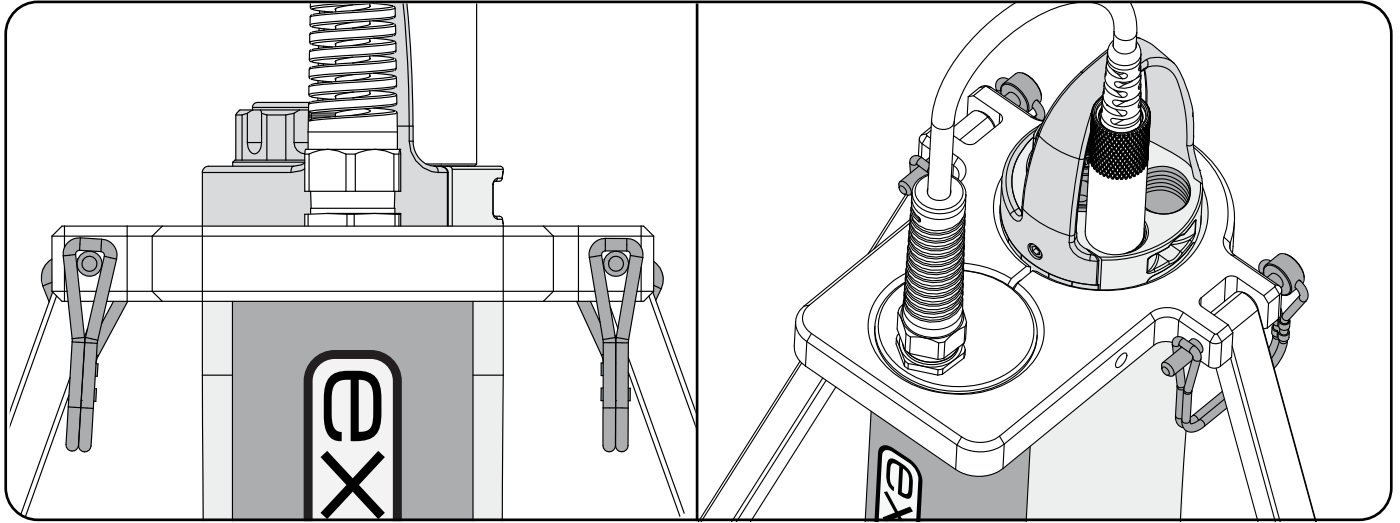

Figure 5 Align the upper clamps with the yellow bulkhead of the sonde

NOTE: In order for the EXO PAR adapter to be recognized, it must be plugged into the AUX port before applying power to the sonde.

2. The bottom of the lower clamp should align with the upper edge of the top chamfer on the clear plastic section covered with the black "EXO²" sonde label. Again proper alignment is necessary so the PAR sensor arms are deployed so that the PAR sensor faces axis is parallel to the sonde axis.

NOTICE: Proper alignment of clamps is necessary to prevent damage.

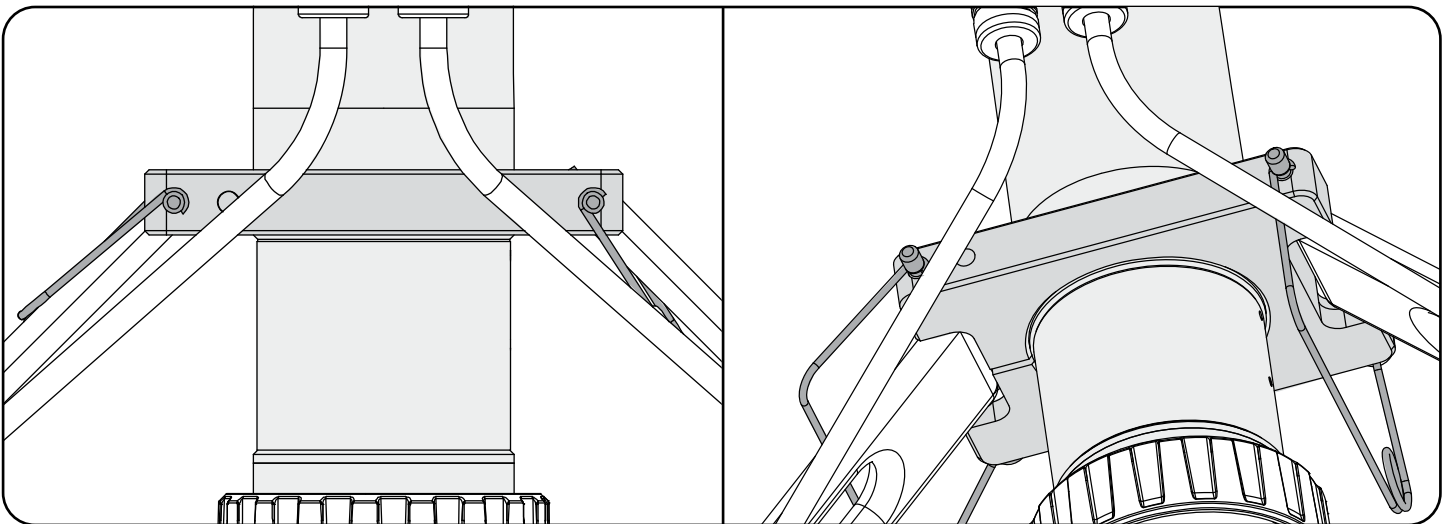

Figure 6 The lower clamp should align with the upper edge of the top chamfer on the clear plastic section

3. Once you have the EXO PAR system secured to the EXO2 sonde body it is time to deploy the sensor arms. To do so simply lift the arms and install the pins where the two arms meet, as shown (figure 7).

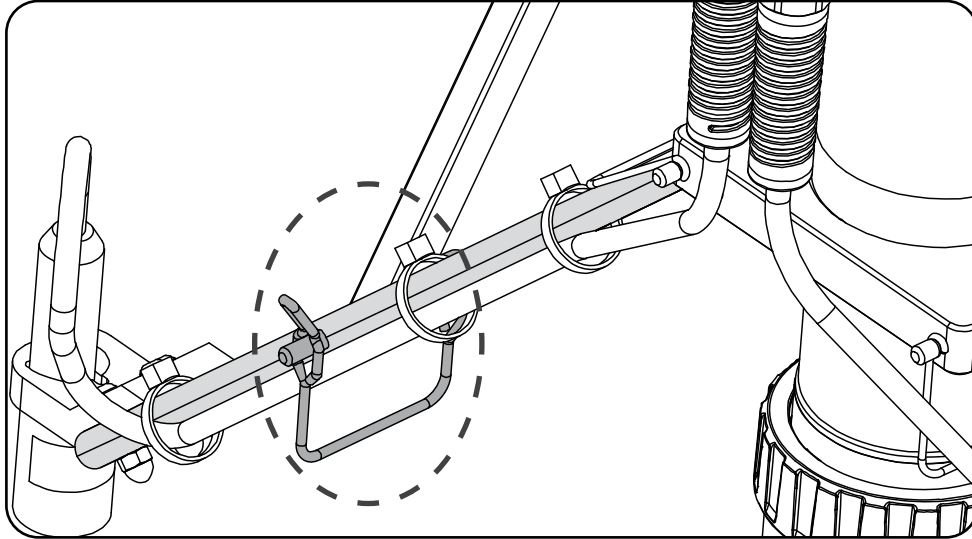



Figure 7 Lift the arms and install the pins where the two arms meet

 **CAUTION:** Potential pinch hazard, be mindful of fingers.

4. After you have installed the upper and lower clamps, it's time to address cable management. There are two cables that connect to your PAR sensors coming from the EXO PAR adapter cylinder. Supplied with your EXO PAR system will be several black, UV resistant Zip Ties. Fasten the sensor cables to the EXO PAR frame support arms as follows: (3 locations)

NOTE: *Dummy plugs are supplied for these cable's connectors, plug these connectors when sensors are removed or if only deploying 1 of your 2 PAR sensors. When not in use, the plugs can be stored in the calibration cup extension.*

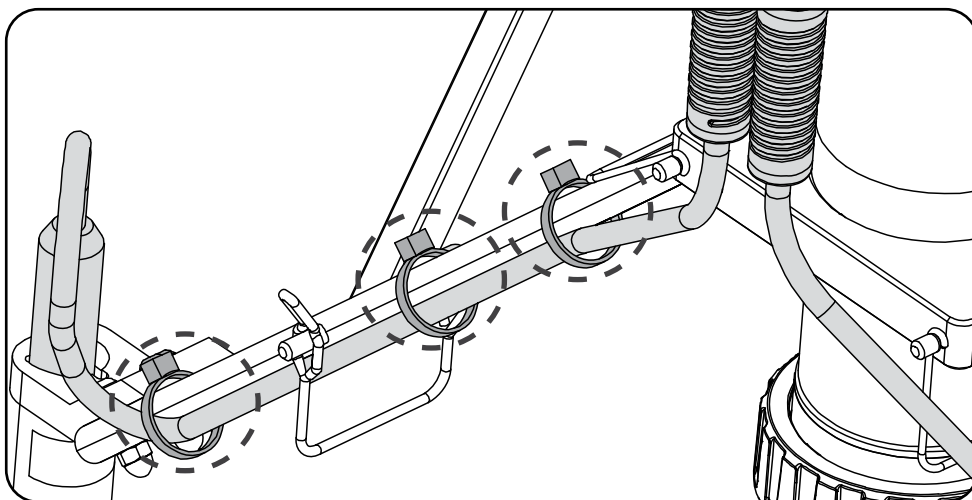

Figure 8 Fasten the sensor cables to the EXO PAR frame support arms

Setup the Kor Software

In the following steps we will cover the setup of the PAR sensor utilizing the YSI Kor software.

1. You will first need to enable the PAR(s) sensor in Kor. To do so you will need to select **File**, and then select **Settings**, and from the list of parameters select **PAR** and you will see figure 8 if done correctly. From this window you can enable either the PAR sensor or sensors by clicking the boxes shown.

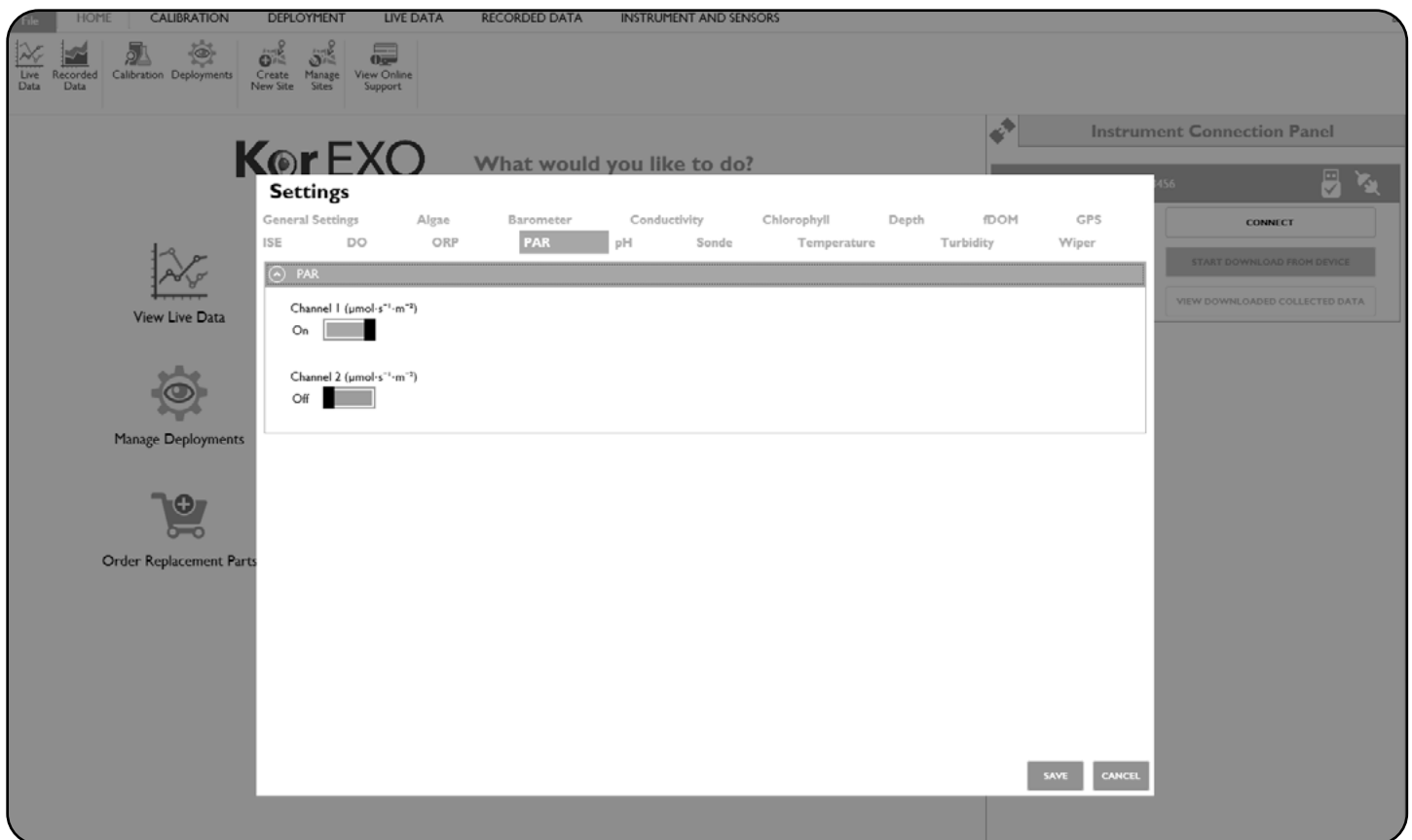

Figure 10 Enable the PAR sensor in Kor

2. Using the Calibration Certificate supplied with your Li-Cor PAR sensor, you will now enter the multipliers into YSI's Kor software. To do so first select **Instruments and Sensors** and from the list of sensors displayed select **PAR** sensor. If successful you will see the screen shown in figure 11. From the Calibration Certificate you will use the **In-Water** multiplier that is listed under the **Handheld Meters and Loggers section**. You will enter the multipliers exactly as they are on the certificates in the fields shown for **Channel 1** and **Channel 2**. If you are only using one PAR sensor, the default channel will be **Channel 1**. Leave the default value in **Channel 2**, which will be (1).

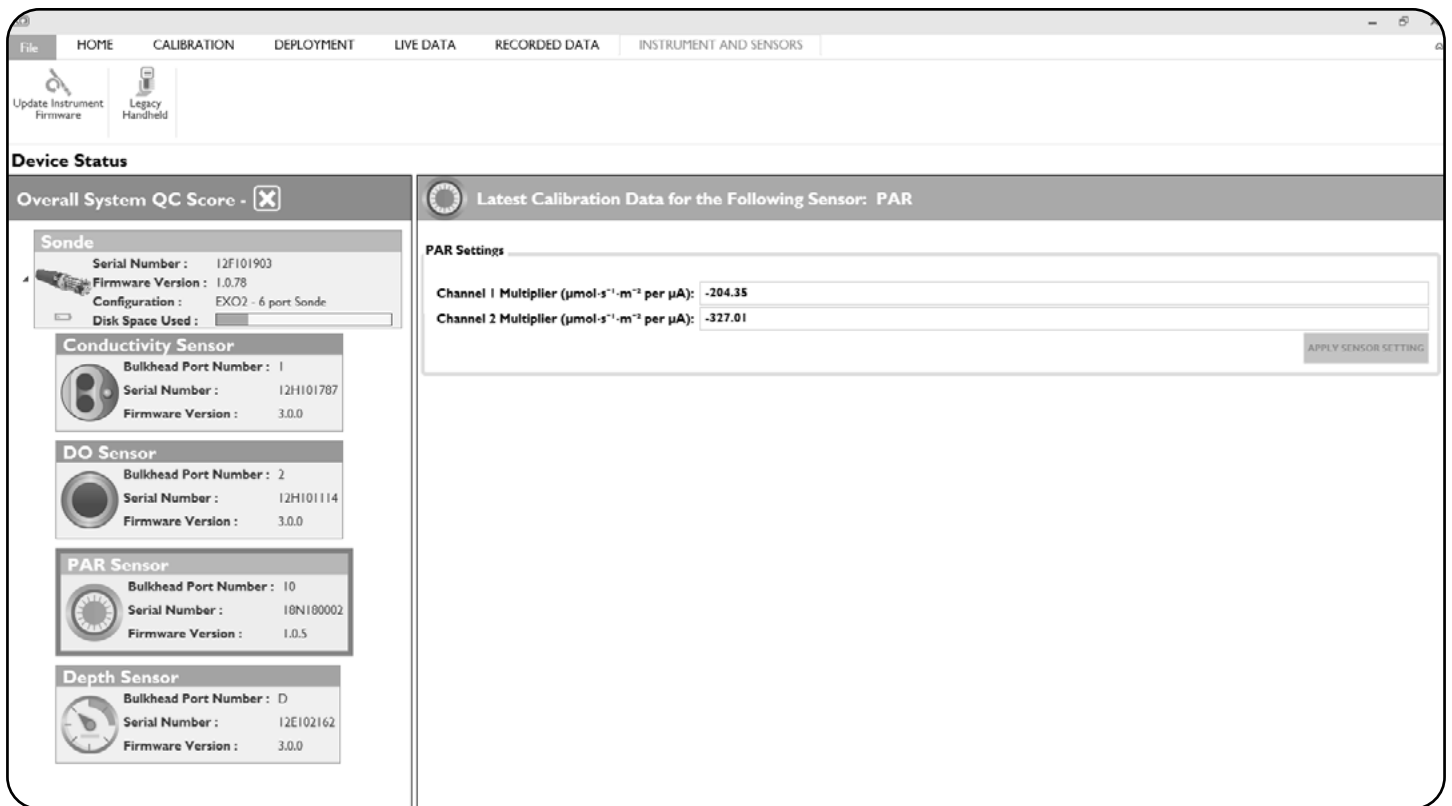

Figure 11 Enter the multipliers into YSI's Kor software.

- Now your PAR sensor(s) are ready to use. You can now see PAR data begin to show up in your Kor Dashboard (example shown in figure 12).

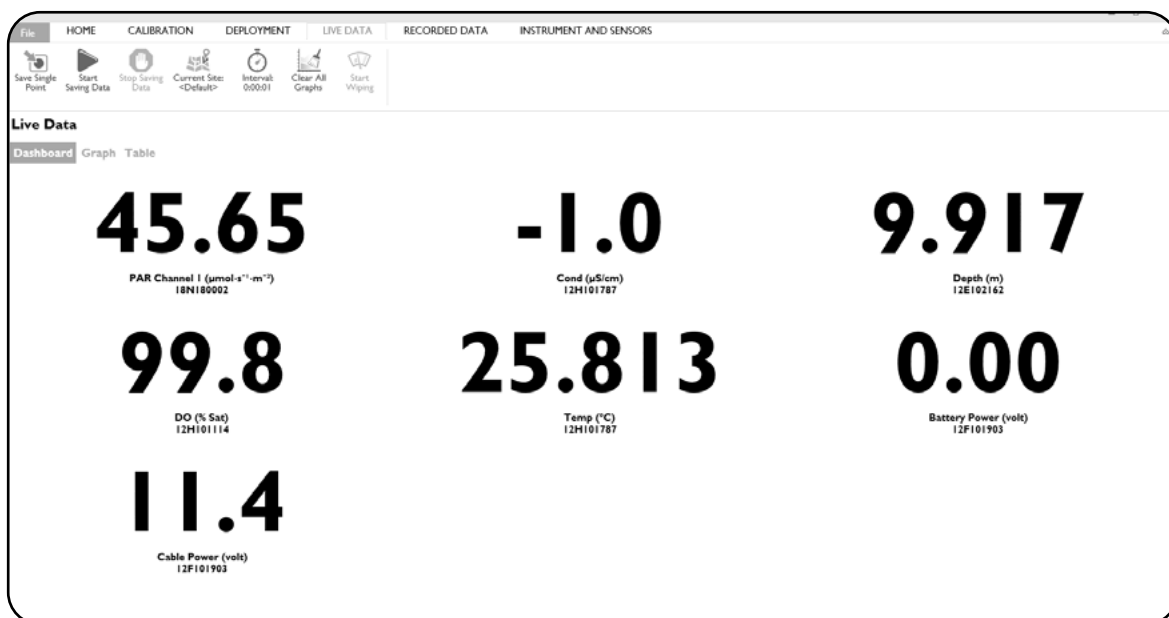

Figure 12 PAR data will begin to show up in your Kor Dashboard

Setup the EXO Handheld Display

In the following section we will cover setting up EXO PAR utilizing the EXO Handheld Display.

1. You will first need to enable the PAR(s) sensor in the EXO Handheld. To do so you will need to select **Handheld**, and then select **Display**, and from the list of **Units** select PAR and you will see figure 13. On the next screen you can enable either the PAR sensor or sensors by clicking the boxes shown, figure 14.

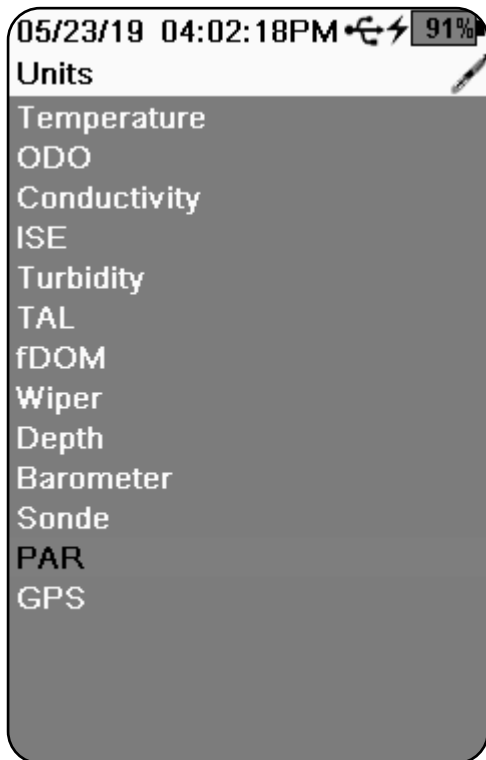

Figure 13 Select PAR from the list of Units

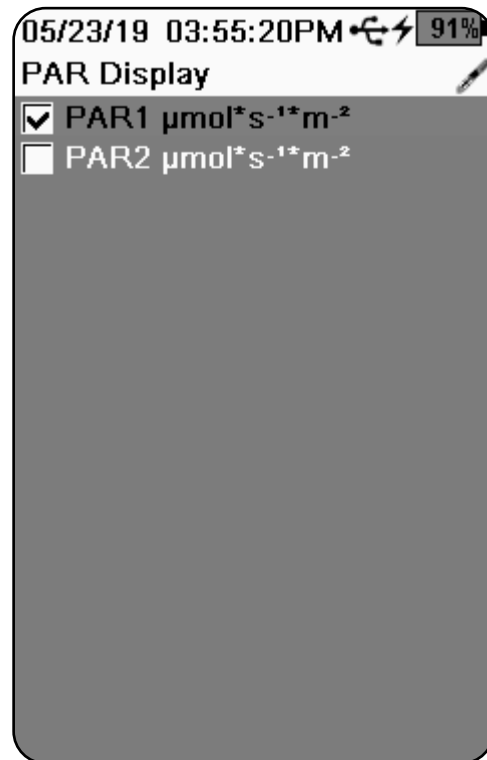

Figure 14 Enable sensors

2. Using the Calibration Certificate supplied with your Li-Cor PAR sensor, you will now enter the multipliers into EXO Handheld Display. To do so first select **Calibration** and from the list of sensors displayed select PAR sensor. If successful you will see the screen shown in figure 15. From the Calibration Certificate you will use the In-Water multiplier that is listed under the Handheld Meters and Loggers section. You will enter the multipliers exactly as they are on the certificates in the fields shown for Channel 1 and Channel 2 shown in figure 16. If you are only using one PAR sensor, the default channel will be Channel 1. Leave the default value in Channel 2, which will be (1).

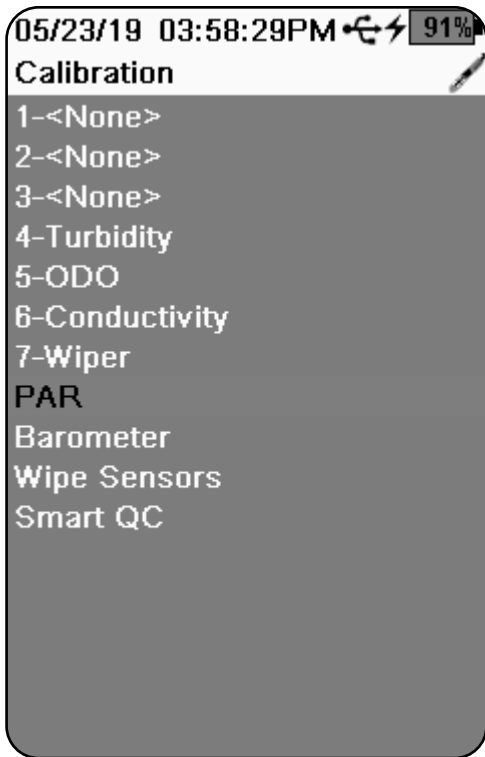

Figure 15 Select calibration, then PAR from the list of sensors

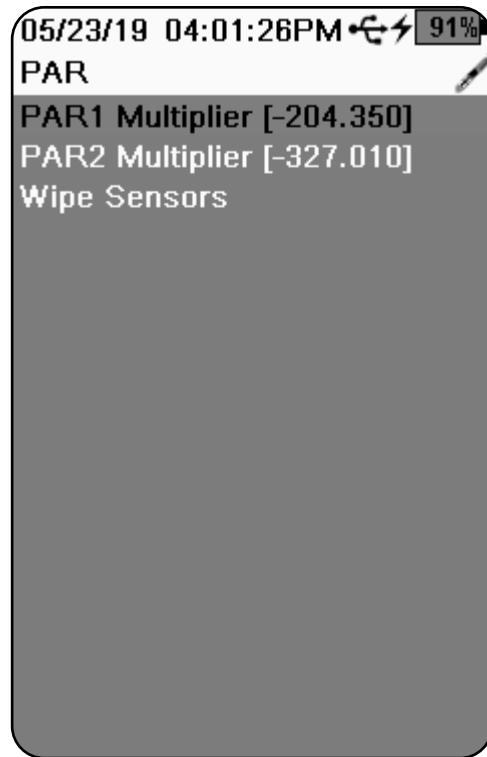

Figure 16 Enter the multipliers exactly as they are on the certificates

3. Now your PAR sensor(s) are ready to use. You can now see PAR data begin to show up in your EXO Handheld Display (example shown in figure 17).



Figure 17 PAR data on EXO Handheld Display

Ordering

Ordering Replacement Components

YSI Item #	Description
351070	EXO PAR Adapter Assembly
351073	EXO PAR, Upper Clamp
351074	EXO PAR, Lower Clamp
351075	EXO PAR, Wide Extension Arm (Lower)
351076	EXO PAR, PAR Sensor Bracket
351077	EXO PAR, Narrow Extension Arm (Upper)
351087	EXO PAR, Clip on Calibration Cup Extender

Ordering

Telephone: 727 565 2201 (USA)

Monday through Friday

8:00 AM to 5:00 ET

Fax: 866 778 8431 (orders)

Email: YSISystemsOrders@Xyleminc.com

Mail: YSI Inc - Systems & Services Division

Attn: Order Entry

7100 Business Park Drive, Suite B

Houston, TX 77041

When placing an order please have the following available:

1. YSI account number (if available)
2. Name and phone number
3. Purchase Order or Credit Card number
4. Copy of Quote (if applicable)
5. YSI Item Number or brief description
6. Billing and shipping addresses
7. Quantity

9.2

EXO Handheld

Mini Manual



EXO Handheld

OPERATION GUIDE

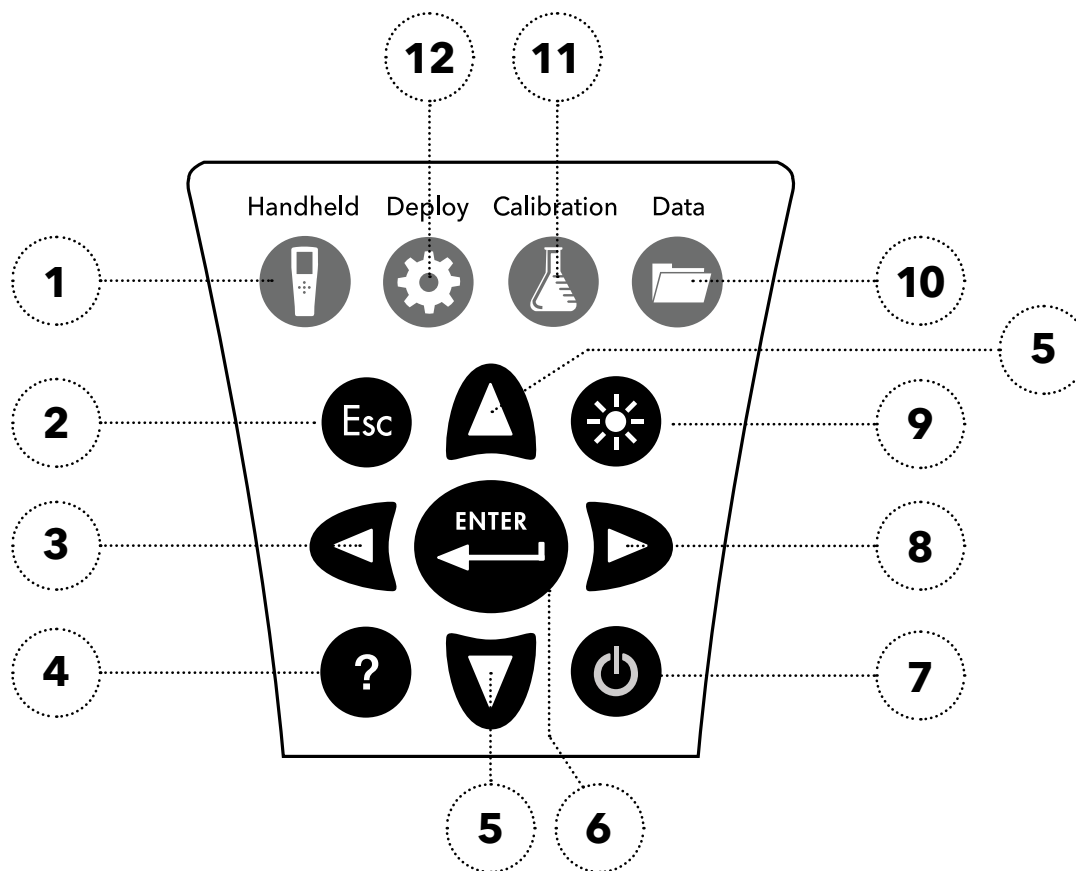

EXO Handheld General Operation

Keypad and Navigation













<p>1 Handheld: Opens the Setup menu. Use to adjust system settings.</p>	<p>7 ON/OFF: Push and hold to turn the handheld on or off.</p>
<p>2 Exit/Escape key: Exits to the Dashboard screen. In an alpha/numeric entry screen, push to return to the previous menu.</p>	<p>8 Right arrow key: Navigates right in an alpha/numeric entry screen. In the Dashboard screen, push to show graphical representations of displayed measurements.</p>
<p>3 Left arrow key: Navigates left in an alpha/numeric entry screen and returns to the previous menu in all other screens. In the Dashboard screen, push to show graphical representations of displayed measurements.</p>	<p>9 Backlight: Turns the keypad backlight on or off. Use for increased visibility in low light conditions.</p>
<p>4 Help: Shows context sensitive help.</p>	<p>10 Data: Opens the Data menu. Use to view, transfer, delete, or backup saved data. Also use to view free memory, and to view or delete calibration records.</p>
<p>5 Up/down arrow keys: Navigates up or down in an alpha/numeric entry screen and scrolls through menus.</p>	<p>11 Calibration: Opens the Calibration menu. Use to calibrate all parameters except temperature. Also use to wipe sensors and view Smart QC status.</p>
<p>6 Enter key: Push to confirm selections. In the Dashboard screen, push to log a single data point or start continuous data logging.</p>	<p>12 Deploy: Opens the Deployment menu. Use to access advanced setup, sonde settings, deployment setup, or start a deployment.</p>

Startup

Push the  key to turn on the handheld. If the handheld does not turn on, make sure that the battery pack is correctly installed and charged. Push and hold the  key for 1.5 seconds to turn off the handheld.



Navigation

The EXO handheld contains menus to change user-defined options, functions, and parameters. Use the arrow keys ( and ) to highlight different options within menus and sub-menus, then push the  key to select the option. Push the  key to return to the previous menu.

Push the  key to return to the Dashboard screen. To enable or disable an option, highlight the option and then push the  key. Enabled functions appear as a circle with a dot  or a box with a check mark . Disabled functions appear as an empty circle  or box .

Alpha/numeric entry

When displayed, enter information into a numeric or alpha/numeric entry screen. Once the information has been entered, highlight **ENTER**, then push the  key (Figure 1).

NOTE: When in an alpha/numeric screen, the  key is for alpha/numeric navigation only. Push the  key to return to the previous menu.

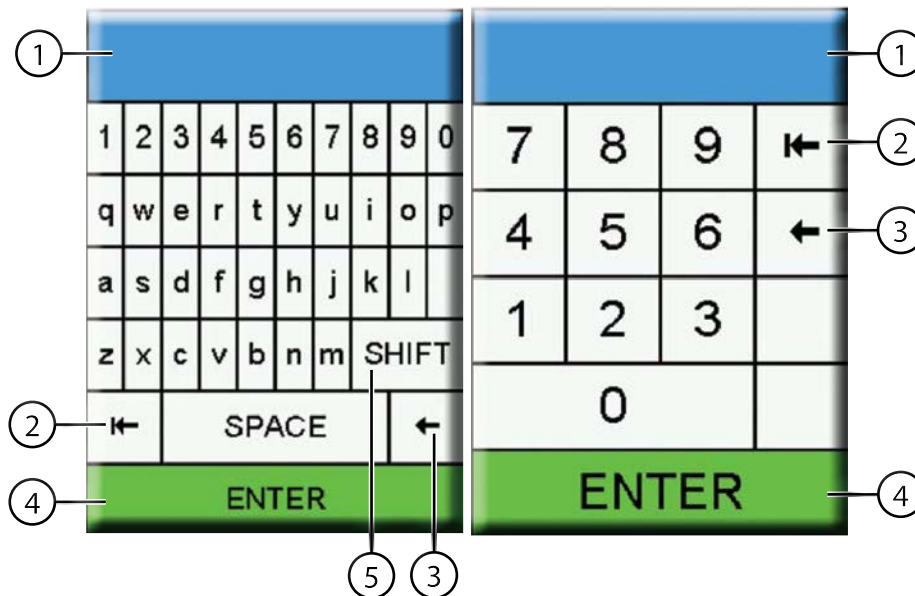



Figure 1 Alpha/numeric and numeric entry screens

1 User entry field	4 Enter selection
2 Delete entire entry	5 Upper/lowercase
3 Backspace	

Dashboard screen description

The Dashboard screen shows the live measurements for units selected in the  → **Display** → **Units** menu. If more measurements are selected than can be displayed on the Dashboard screen, a scroll bar will be shown. Use the ▲ and ▼ arrow keys to view additional measurements (Figure 2).

The message area shows status messages, error messages, and information about selected functions.

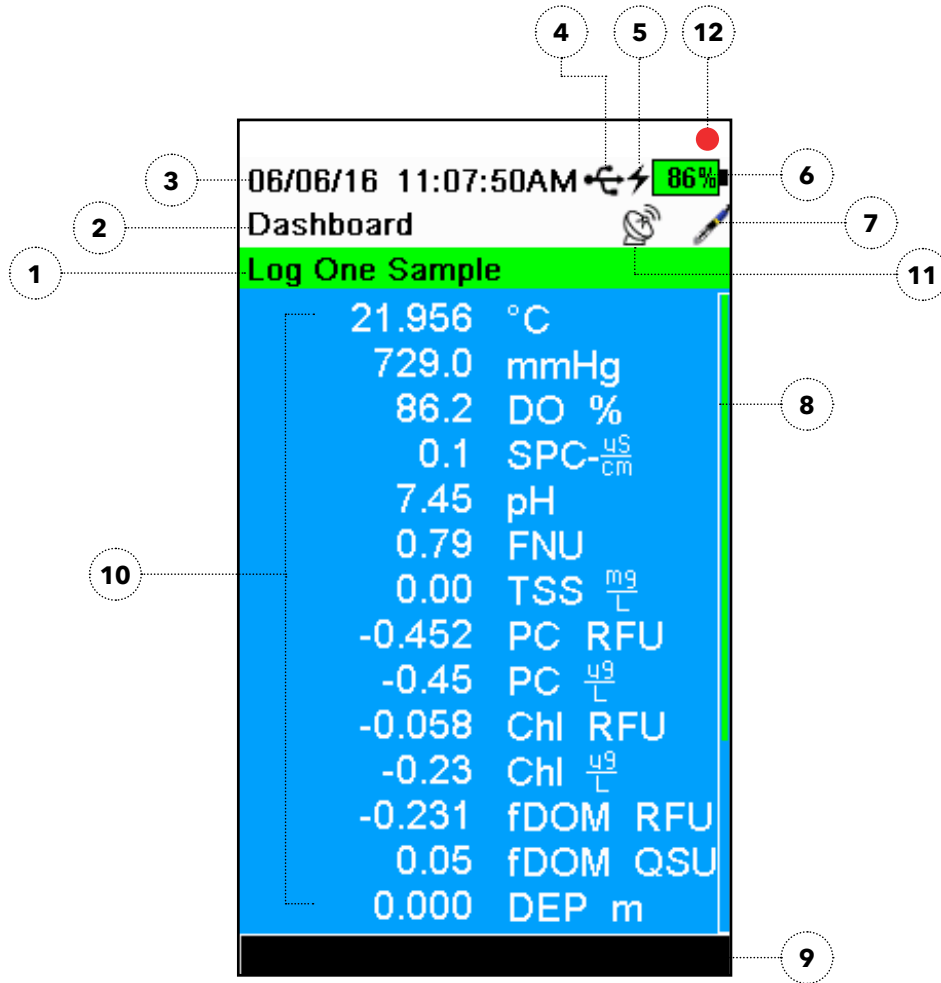



Figure 2 Main display example

1	Log or sampling prompt on Dashboard screen (single or continuous)	7	Sonde connection indicator
2	Current screen/menu	8	Scroll bar
3	Date/Time	9	Message area
4	USB/PC connection indicator	10	Displayed measurements
5	Battery charging indicator	11	GPS signal indicator
6	Remaining battery charge	12	Fault code indicator

EXO Handheld Menu

Handheld Display

Push Handheld  key to view and adjust instrument settings. Highlight a sub-menu then push the  key to view the sub-menu options (Figure 3).

Pre-defined or user-selected options are noted within brackets ([]). [See Alpha/numeric entry.](#)

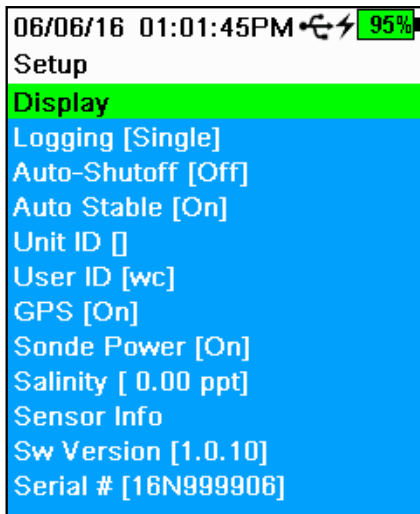

Figure 3 Handheld Menu

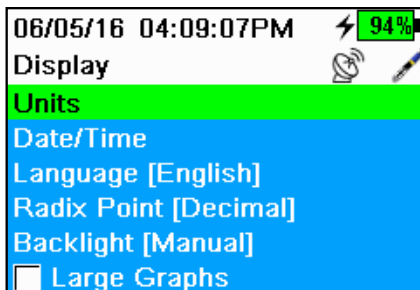

Figure 4 Display Menu

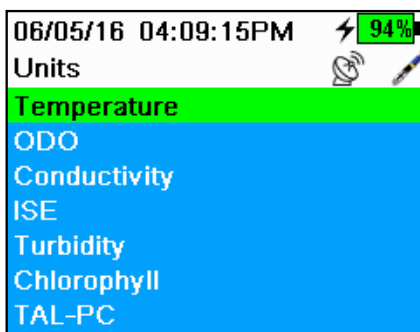



Figure 5 Units Menu

Use the Handheld menu to:

- Setup or change display settings
- Configure logging options ([Logging](#))
- Set an auto-shutoff time for the Handheld
- Change the auto-stable settings
- View and adjust the Unit ID
- View and adjust the User ID
- Turn GPS mode on or off
- Turn power to the sonde on or off
- View sensor specific information ([Sensor info](#))
- View the software version ([Software version](#))
- View the handheld serial number ([Serial #](#))

Handheld Display menu

 → Display

The Handheld Display menu has options to view or change measurement units, date/time, language, radix point, backlight mode, and display brightness.

Use the Display menu to:

- Setup or change displayed parameters
- Set the date and time ([Date/Time](#))
- Change the language setting ([Language](#))
- Change the radix point ([Radix Point](#))
- Set the backlight mode ([Backlight](#))
- Change the graph display size ([Graph Display](#))
- Adjust the display brightness ([Brightness](#))

Display Units

 → Display → Units

The Display Units menu determines the sensor measurements and measurement units displayed on the Dashboard screen. The Dashboard screen will only show measurements for sensors that are installed in the connected sonde.

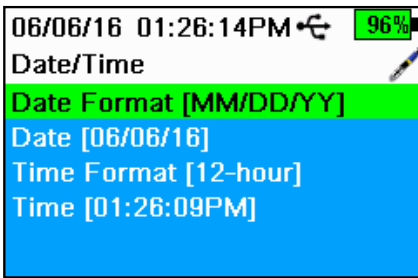

Figure 6 Date/Time



Figure 7 Language

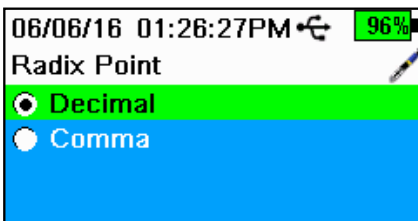

Figure 8 Radix Point

Date/Time

 → **Display** → **Date/Time**

For accurate logging and calibration data, set the date and time for the EXO handheld (Figure 6).

Date/Time options:

- Set YY/MM/DD, MM/DD/YY, DD/MM/YY or YY/DD/MM date format
- Set the current date
- Select 12 or 24 hour time format
- Set the current time

Display Language

 → **Display** → **Language**

The EXO handheld is shipped with English as the default language. When the language setting is changed, the handheld will take 10 to 20 seconds to update the language settings.

Included languages

- French
- German
- Italian
- Japanese
- Norwegian
- Portuguese
- Simplified Chinese
- Spanish
- Traditional Chinese

Radix Point

 → **Radix Point**

The radix point can be changed to display a comma or a decimal in numeric displays (e.g. 1.00 becomes 1,00 when Comma is selected) (Figure 8).

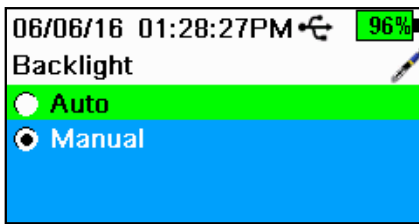



Figure 9 Backlight

Display Backlight

 → **Display** → **Backlight**

In **Automatic mode**, the keypad backlight will turn off 60 seconds after the last key is pushed. Once any key is pushed, the keypad backlight will turn back on and remain on for another 60 seconds of inactivity.

When **Manual mode** is selected, the handheld backlight key is used to turn the keypad backlight on or off (Figure 9).

NOTE: In low light conditions, set the backlight to remain on using Manual mode.

Display Large Graphs

 → **Display**

For larger graphical displays of data, select the **Large Graphs** check box and then push the  key.

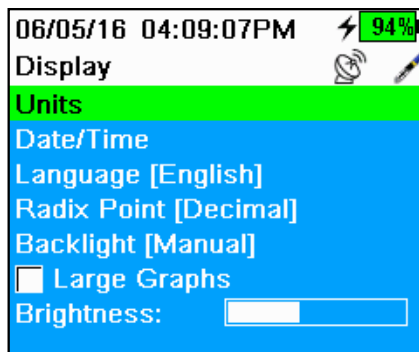



Figure 10 Brightness

Display Brightness

 → **Display** → **Brightness**

The screen display brightness can be adjusted to accommodate lighting conditions and to conserve battery power (Figure 10).

Select **Brightness** and then use the ◀ and ▶ arrow keys to adjust the screen brightness.

NOTE: In bright conditions, set the screen brightness to 75% or greater.

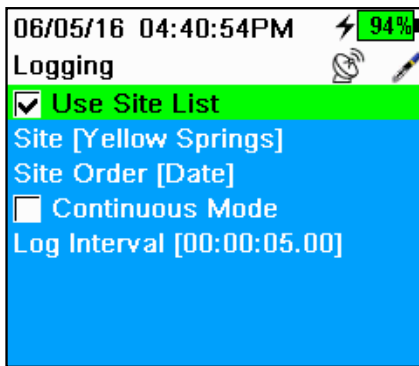



Figure 11 Logging

Logging

→ Logging

The Logging menu has options for user-defined sites to be included with the logged data. When the Site List is enabled, select which site to save data to when logging.

Highlight **Use Site List** check box and push the  key to enable the Site List feature.

Select **Site** to access the Site List menu, where new sites can be added and previously saved sites can be edited or deleted.

Select **Site Order** to change how the site names are arranged in the Site List, either by name, date, or distance.

Continuous Mode (interval logging): When Continuous mode is enabled, the handheld will log data at a specified interval until stopped. Edit the logging time interval by selecting **Log Interval**. The Dashboard screen will display **Start Logging...** when in Continuous mode.

One Sample Logging: When Continuous mode is not selected, the Dashboard screen will display **Log One Sample**. A single sample will be logged each time the  key is pushed when in the Dashboard screen.

NOTE: An option to change the Site appears once the  key is pressed on the Dashboard screen to begin logging, as does an option to wipe sensors before taking a measurement if a wiper is installed.

Auto-Shutoff

→ Auto-Shutoff

To conserve battery power, auto-shutoff powers off the handheld after a user-defined time period (in minutes) Set to 0 (zero) to disable Auto-Shutoff.

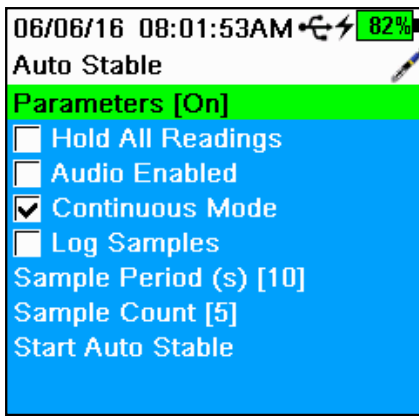

Figure 12 Auto Stable

Auto Stable

⚙️ → Auto Stable

Auto Stable indicates when a measurement is stable and can be monitored for each parameter.

Sensors with Auto Stable enabled will have ^AS or ^AS flash beside the measurement on the Dashboard screen.

^AS will flash green when the measurement is stable

^AS will flash red when a measurement is unstable

Hold All Readings: After all sensors have reached their stability criteria, the measurements will be held or 'locked' on the display. If disabled, the sensor measurements will continue to change in real time.

Audio Enabled: An audio alert will sound when stability is reached.

Continuous Mode: The EXO handheld will continuously check sensor values against the stability criteria even after the sample period and sample count have been met.

Log Samples: Logs the sample/s defined by the Sample Period to memory.

Sample Period: Time interval between the sensor measurements (sample) that are used to determine stability. Set the interval in seconds (1 to 900).

Sample Count: Number of consecutive samples required for stability (1 to 10).

Auto Stable Parameters

⚙️ → Auto Stable → Parameters

Enter the stability value, then select **Use Percent** or **Use Meas. Units** (Figure 13).

This threshold is used to compare the last reading with the previous. The smaller the number entered in % or units, the longer it will take for the instrument to reach the auto stable criteria.

Example: For temperature in °C, if unit threshold is set to 0.2 and the temperature reading changes by more than 0.2 degrees, ^AS will continue to be red until the reading does not change by more than 0.2 °C over the defined sample period and sample count.

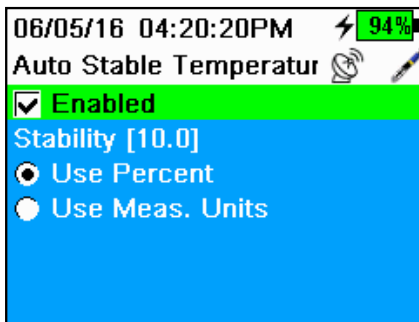

Figure 13 Auto Stable Temp.

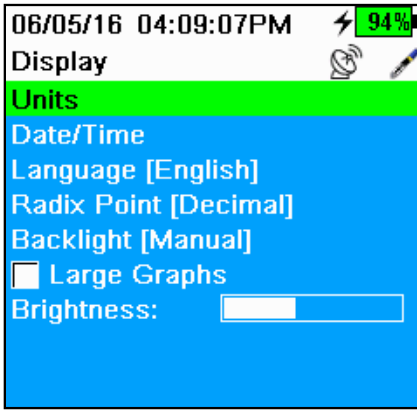

Figure 14 Display

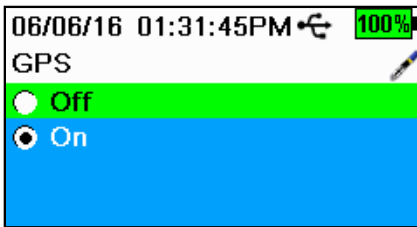
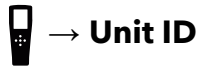

Figure 15 GPS

Unit ID



The Unit ID is specific to the instrument and is used to identify calibration files, Site Lists, Configuration Files, and Data files transferred from the handheld to a PC.

User ID



The User ID is a record of who used the Handheld to record data or calibrate sensors. This metadata is stored with each calibration record.

GPS

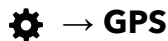

Use the GPS menu to turn the Global Positioning System On or Off. The  symbol is displayed when a GPS signal is received (Figure 15).

When enabled, the GPS coordinates will be saved with calibration records and logged data.

NOTE: *GPS data will be most accurate when there is a clear line of sight to satellites. GPS will not typically receive a signal while inside a building.*

NOTE: *Disabling GPS will conserve handheld battery power.*

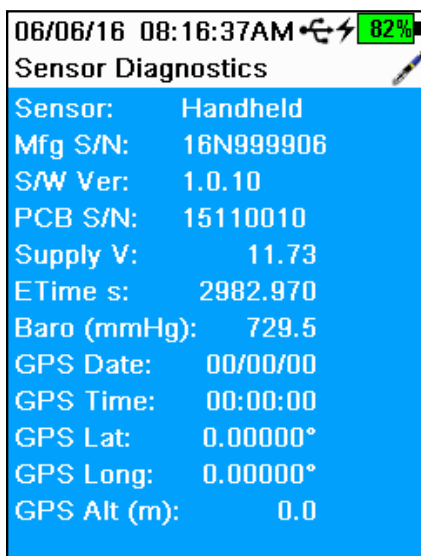

Figure 16 Sensor Diagnostics

Sensor info



The Sensor info menu displays information about the handheld and each connected sensor. Use this menu to view sensor settings, measurement data, Smart QC Scores, and software/hardware information. Use the ▲ and ▼ arrow keys to scroll through information about each component.

NOTE: *This is a helpful menu to review when troubleshooting with a technical support representative.*

Software (Sw) Version



This menu displays the EXO handheld software version currently installed on the instrument.

NOTE: *The latest instrument software version can be downloaded using the KorEXO PC software program available from YSI.com.*

Serial



Serial # shows the serial number of the EXO handheld instrument. Note the serial number when contacting YSI support.

EXO Handheld Deploy Menu

Deploy Menu

Use the Deploy  key to configure sonde deployment settings, view the current status of a deployment, or to start or stop a deployment.

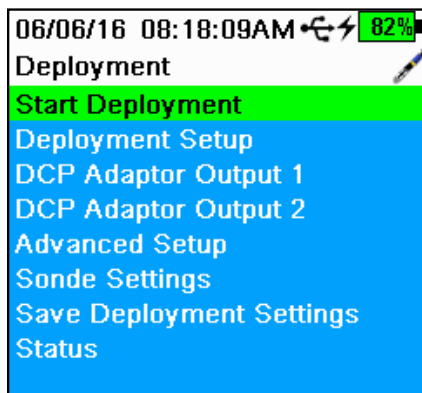

Figure 17 Deployment

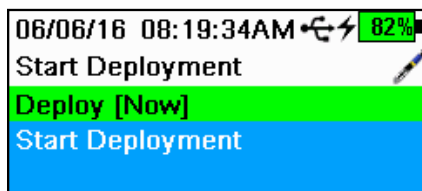

Figure 18 Start Deployment

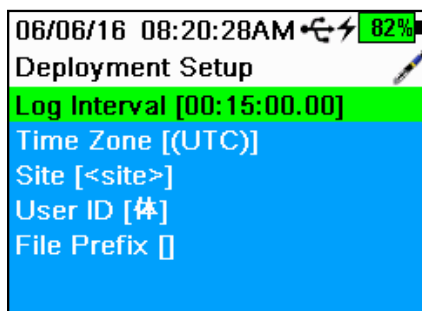

Figure 19 Deployment Setup

Use the Deployment menu to

- Start or stop a sonde deployment
- Setup deployment options
- Setup DCP adapter outputs (for external data loggers)
- Access advanced setup options
- View or change sonde specific settings
- Save updated settings to sonde without starting deployment
- View current sonde configuration

Start Deployment

→ Start Deployment

Select when the sonde begins logging measurements autonomously in the Start Deployment menu.

Deploy: Setup when the sonde will begin collecting data. Select **Now** to immediately begin autonomously data collection or select **Next Interval** to begin collecting data on the next logging interval. Select **Custom Time** to have the sonde begin data collection at a specified time.

Start Deployment: Select to begin collecting data with the current deployment settings. To stop deployment, return to the Deployment menu and select **Stop Deployment**.

Deployment Setup

→ Deployment Setup

Select how the sonde collects and tags data autonomously during deployment.

Log Interval: Set the duration of time the sonde waits between logging data measurements.

Time Zone: Set the time zone where the sonde will be deployed.

Site: Set a Site name to record where the sonde was deployed while collecting data.

User ID: Enter a User ID to identify who setup the deployment.

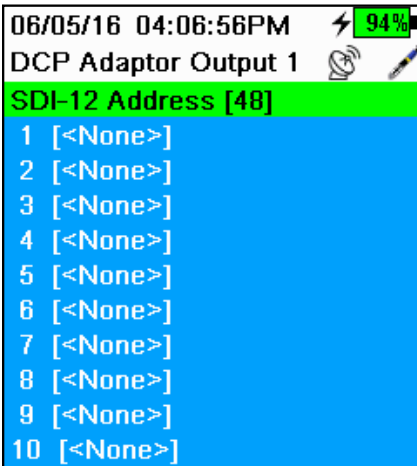

Figure 20 DCP Adaptor Output

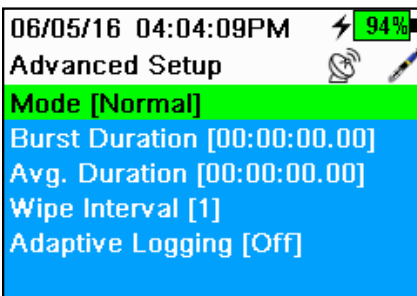

Figure 21 Advanced Setup

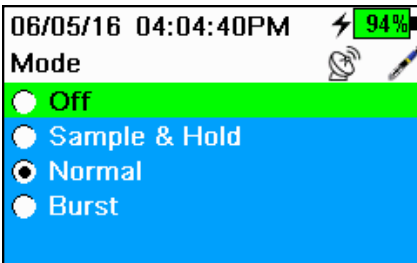

Figure 22 Mode Menu

DCP Adaptor Outputs

⚙️ → DCP Adapter Output (1 or 2)

The Data Collection Platform (DCP) Adapter Output menu is for users who have a DCP Adapter and are connecting a sonde to an external data logger. Use the DCP Adapter menu to setup how the sonde interacts with the data logger.

Set the address to a number (0-9) or a single letter (A-Z) so that the data logger can identify from which source the data should be pulled.

Set which parameters the data logger will record and the order in which that data is collected. Refer to the main user manual to learn more about DCP adapter functions.

NOTE: *The sonde and the data logger must be set with the same parameters, in the same order.*

Advanced Setup

📱 → Advanced Setup

The Advanced Setup menu offers advanced users additional deployment settings for sonde data collection.

Advanced Setup Mode

📱 → Advanced Setup → Mode

This advanced menu allows users to customize how the instrument logs data.

Sample & Hold: This mode is helpful when connecting a sonde to a data logger. In this mode the sonde saves collected data to an internal SD card, which can later be accessed by another device. The information stored on the SD card acts as a backup if the data logger experiences an error.

Normal: The sonde will clean sensors with a Central Wiper (if installed), collect data for one minute, and average that data into a single data point. The period of time over which the sonde collects data to be averaged can be changed by selecting **Avg. Duration** from the Advanced Setup menu.

Burst: The sonde will collect data once every second over a user-defined time period. The period of time over which the sonde collects data can be changed by selecting **Burst Duration** from the Advanced Setup menu.

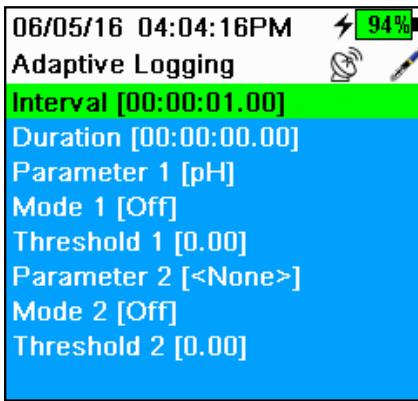

Figure 23 Adaptive Logging

Advanced Setup Wipe Interval

 → **Advanced Setup** → **Wipe Interval**

Set the interval (in measurements) between when sensors are wiped.

Advanced Setup Adaptive Logging

 → **Advanced Setup** → **Adaptive Logging**

The Adaptive Logging option is used to temporarily change the defined sonde logging interval if one or two specified parameters exceed a user-defined threshold. This feature is helpful for capturing additional data during events (floods, illicit discharges, algal blooms, etc.).

When data exceeds set thresholds during a logging interval (defined in Deployment Setup), the logging interval will automatically increase to a user-specified frequency. Once data fall back within threshold limits, the logging interval will return to its defined settings.

Assign Adaptive Logging for up to two parameters by selecting **Parameter 1** and/or **Parameter 2**. Select **Mode** to choose if Adaptive Logging will activate if a parameter rises above or dips below a set threshold.

Set the new logging interval when these parameters exceed the set threshold. Also, set the duration the sonde will continue collecting data at the modified logging interval.

NOTE: *When adaptive logging is enabled, all memory and battery life estimates are no longer accurate.*

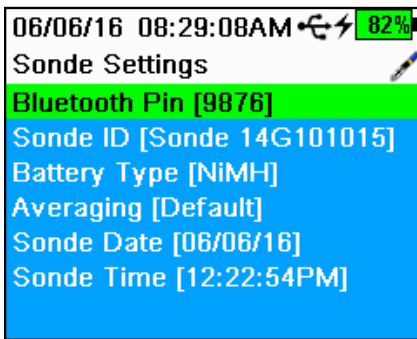

Figure 24 Sonde Settings

Sonde Settings

→ Sonde Settings

View or change sonde-specific settings in the Sonde Settings menu, including the sonde date and time, bluetooth pin number, battery type, and averaging mode.

Use the Sonde Settings menu to

- Assign a bluetooth pin number
- View or change the Sonde ID
- Select the sonde battery chemistry
- Access Sonde Settings
- Set the sonde date and time
- Save Deployment Settings
- View the Deployment Status

NOTE: After the sonde settings have been entered, highlight Save Deployment Settings and push the  key.

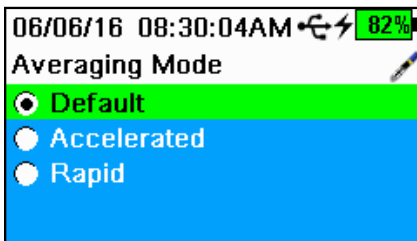

Figure 25 Averaging Mode

Sonde Settings Averaging

→ Sonde Settings → Averaging

Default mode provides optimum data filtering for all sensors and the highest accuracy during unattended monitoring at a fixed location. This mode has up to 40 seconds of filtering on sensors.

NOTE: All sensors ship in default mode.

In **Accelerated** mode, sensors record data with a smaller rolling average window (5-10 seconds), so changes in sensor response are more quickly observed.

Accelerated mode is recommended when the sensors are moving through the water (e.g. profiling studies and most spot sampling applications).



NOTE: For depth profiling, enable Vertical Position under Depth Display to view the real-time position of the depth sensor in the water column. This is helpful in profiling applications to ensure the depth sensor is lowered to the desired depth without waiting for the depth data to stabilize.

Rapid mode should be used when the sonde is moving quickly through the water, such as with rapid profiling and unique applications (e.g. towed applications). The data will be noisy and will never settle on a single steady number. This mode has 2-3 second filtering on sensors.

NOTE: The averaging mode chosen within this menu will be saved to the sonde, not to the sensors or handheld.

EXO Handheld Calibration Menu

Calibration menu

Push the  key to access the Calibration menu (Figure 26). Highlight a sub-menu then push the  key to view sub-menu options.

NOTE: Only sensors installed in the sonde will appear on the Calibration menu screen

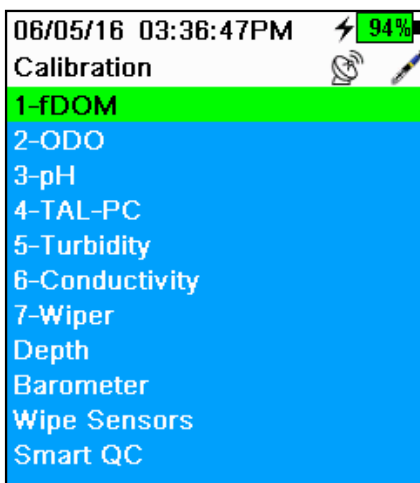

Figure 26 Calibration

Use the Calibration menu to:

- Calibrate sensors
- Setup sensors for calibration
- Restore default calibrations
- Set a Calibration Reminder
- Wipe sensors
- View Smart QC scores

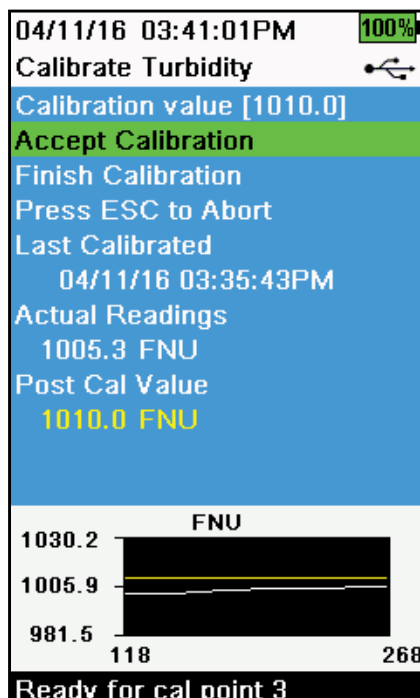

Figure 27 Calibration Screen

Calibration Screen Layout

The calibration screen has the same basic layout for each parameter (Figure 27).

Calibration value: The value to which the sensor will be calibrated.

The **Yellow Line** on the graph corresponds to this value.

Accept Calibration: Calibrates the sensor to the calibration value.

Finish Calibration: Only available with multi-point calibrations (i.e. pH, ISE, turbidity). Finishes the calibration by applying previously accepted points.

Press ESC to Abort: Press the ESC key to leave the calibration. The sensor will not be calibrated to any points. The last successful calibration will be used.

Last Calibrated: Date and time of the last successful sensor calibration.

Actual Readings: The current measurement value on the Run screen. The **White Line** on the graph corresponds to this value. Observe the **White Line** to ensure the measurement is stable before choosing **Accept Calibration**.

Post Cal Value: The same as the calibration value. This will be the measurement value in the current solution after the calibration is finished.

Sensor-Specific Setup Menus

Setup ODO

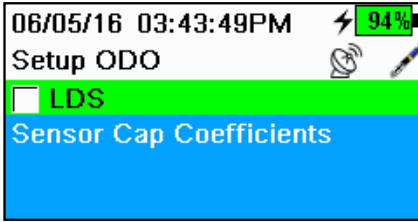



Figure 28 Setup ODO

⚙️ → ODO → Setup

LDS: Last Digit Suppression (LDS) rounds the Dissolved Oxygen (DO) value to the nearest tenth, e.g. 8.27 mg/L becomes 8.3 mg/L.

Sensor Cap Coefficients: The sensor cap coefficients must be updated after sensor cap replacement to maintain Optical Dissolved Oxygen (ODO) accuracy. Update the sensor cap coefficients using the Handheld and the coefficient sheet provided with the new sensor cap.

Update sensor cap coefficients by entering the K1-K7 and KC values from the sensor cap calibration sheet. When the values have been entered, highlight

Update Coefficients and push the  key to save the coefficients. Alternatively, coefficients can be entered into the KorEXO software application and loaded into the instrument.

Setup Turbidity TSS Coefficients

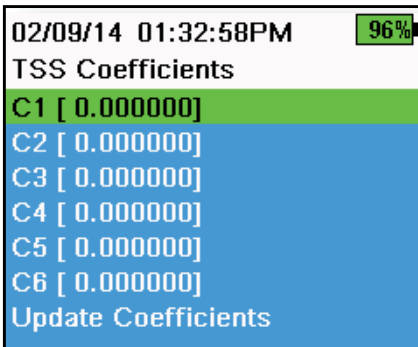



Figure 29 TSS Coefficients

⚙️ → Turbidity → Setup

TSS Coefficients are calculated in KorEXO by entering turbidity and Total Suspended Solids (TSS) correlation data.

Measure turbidity and take a grab sample for laboratory analysis of TSS to obtain a value pair for the correlation. At least two and up to six value pairs can be entered into KorEXO.

Update TSS coefficients by entering the C1-C6 values in the TSS Coefficients sub-menu. When the values have been entered, highlight **Update Coefficients**

and push the  key to save the coefficients. Alternatively, coefficients can be entered into the KorEXO software application and loaded into the instrument.

NOTE: For highest accuracy, obtain 6 values pairs and calculate new coefficients for each unique sampling site.

Setup pH

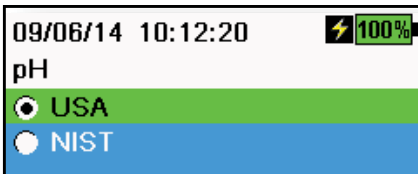

Figure 30 Setup pH

⚙️ → pH → Setup

Select the preferred automatic buffer recognition mode to use for pH calibration. Select either **USA** (4.01, 7.00, and 10.01) or **NIST** (4.01, 6.86, and 9.18) (Figure 30). Calibration standard values are automatically compensated for temperature for both buffer sets.

Setup fDOM / TAL

⚙️ → fDOM / TAL → Setup

For more information on fDOM and Total Algae setup and calibration, please see the full EXO User Manual.

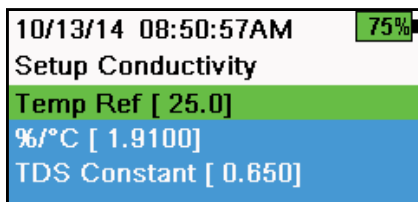

Figure 31 Setup Conductivity

Setup Conductivity

⚙️ → Conductivity → Setup

Temp Ref (Temperature Reference): The reference temperature is used to calculate temperature-compensated specific conductance readings. The default Temperature Reference value is 25 °C (77 °C) (Figure 31). Set the Temperature Reference to a different value by selecting Temp Ref and entering a value between 15.00 °C (59 °F) and 25.00 °C (77 °F).

%/°C (Percent per degree Celsius): Percent per degree Celsius is the temperature compensating coefficient used for Specific Conductance readings. The default is 1.91% based on KCl standards. To change the coefficient, enter new value between 0 and 4%.

TDS Constant: The total dissolved solids (TDS) constant is a multiplier used to calculate an estimated Total Dissolved Solids (TDS) value from conductivity. The multiplier is used to convert specific conductance in mS/cm to TDS in g/L. The default value is 0.65. Enter a new value between 0 and 0.99.

This multiplier is highly dependent on the nature of the ionic species present in the water sample. To be assured of moderate accuracy for the conversion, you must determine a multiplier for the water at your sampling site. Use the following procedure to determine the multiplier for a specific sample:

1. Determine the specific conductance of a water sample from the site.
2. Filter a portion of water from the site.
3. Carefully measure a volume of the filtered water. Completely evaporate to yield a dry solid.
4. Accurately weight the remaining solid.
5. Divide the weight of the solid (in grams) by the volume of water used (in liters) to yield the TDS value in g/L for the site.
6. Divide the TDS value in g/L by the specific conductance of the water in mS/cm to yield the conversion multiplier.

NOTE: Make sure to use the correct units.

NOTE: If the nature of the ionic species at the site changes between sampling studies, the TDS values will be in error. TDS cannot be calculated accurately from specific conductance unless the make-up of the chemical species in the water remains constant.

Conductivity

A conductivity/temperature sensor must be installed for accurate temperature compensation and measurements of all parameters. Temperature calibration is not available or required for accurate temperature measurements.

The conductivity/temperature sensor can measure and calculate conductivity, specific conductance (temperature compensated conductivity), salinity, non-linear function (nLF) conductivity, TDS, resistivity, and density. Calibration is only available for specific conductance, conductivity, and salinity. Calibrating one of these options automatically calibrates the other conductivity/temperature parameters listed above. For both ease of use and accuracy, YSI recommends calibrating specific conductance.

Conductivity calibration

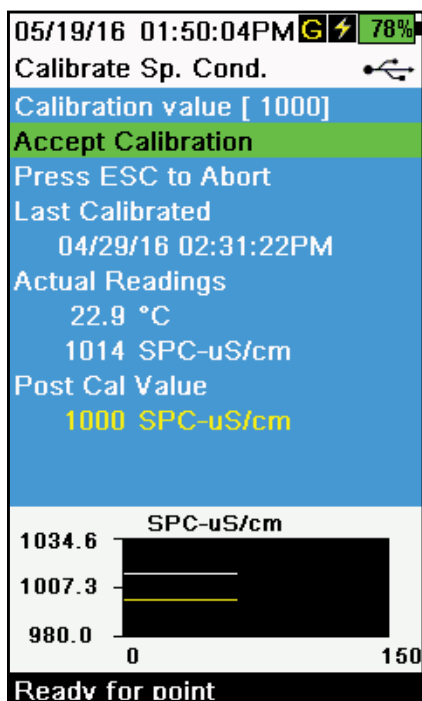



Figure 32 Calibrate Conductivity

1. If necessary, clean the conductivity cell with the supplied soft brush. See full EXO User Manual for more details on sensor maintenance.
2. Perform the related Calibration setup [on the previous page](#).
3. Place the correct amount of conductivity standard into a clean and dry or pre-rinsed calibration cup.

NOTE: Select the appropriate calibration standard for the conductivity of the sampling environment. Standards greater than 1 mS/cm (1000 $\mu\text{S}/\text{cm}$) are recommended for the greatest stability. For fresh water applications, calibrate to 1,000 or 10,000 μS . For salt water applications, calibrate to 50,000 μS .

4. Carefully immerse the sensors into the solution. Make sure the solution is above the vent holes on the side of the standard conductivity sensor, or above the sensor face of the Wiped conductivity sensor.
5. Gently rotate and/or move the sensor up and down to remove any bubbles from the conductivity cell. Allow at least one minute for temperature equilibration before proceeding.
6. Push the  key, select **Conductivity**, then select **Specific Conductance**.

NOTE: Calibrating any conductivity calibration option will automatically calibrate the other options. Specific conductance is recommended for both ease of use and accuracy.

7. Select **Calibration value** then enter the calibration value of the standard used. Note the measurement units the instrument is reporting and calibrating and be sure to enter in the correct calibration value for the units being used. For example, 10,000 μS = 10 mS. Make sure that the units are correct and match the units displayed on the handheld.
8. Observe the actual measurement readings for stability (white line on graph shows no significant change for 40 seconds), then select **Accept Calibration** (Figure 32). "Calibration successful!" will be displayed in the message area.

NOTE: If the data is not stabilized after 40 seconds, gently rotate the sensor or remove/reinstall the calibration cup to make sure that no air bubbles are in the conductivity cell.

NOTE: If the actual measurement data is about 1/2 of the expected calibration value, the conductivity sensor is not completely submerged. Add more calibration standard to the calibration cup.

NOTE: If you get calibration error messages, check for proper sensor immersion, verify the calibration solutions is fresh, the correct value has been entered into the EXO Handheld, and/or try cleaning the sensor.

9. Rinse the Sonde bulkhead and sensors in clean water then dry.

Barometer

The barometer is factory calibrated and should rarely need to be recalibrated. The barometer is used for DO calibration, and %Local measurements. Verify that the barometer is accurately reading “true” barometric pressure and recalibrate as necessary.

Laboratory barometer readings are usually “true” (uncorrected) values of air pressure and can be used “as is” for barometer calibration. Weather service readings are usually not “true”, i.e. they are corrected to sea level and cannot be used until they are “uncorrected”. Use this approximate formula:

True BP in mmHg=[Corrected BP in mmHg] - [2.5*(Local altitude in ft. above sea level/100)]

Example:

Corrected BP = 759 mmHg

Local altitude above sea level = 978 ft

True BP = 759 mmHg - [2.5*(978ft/100)] = 734.55 mmHg

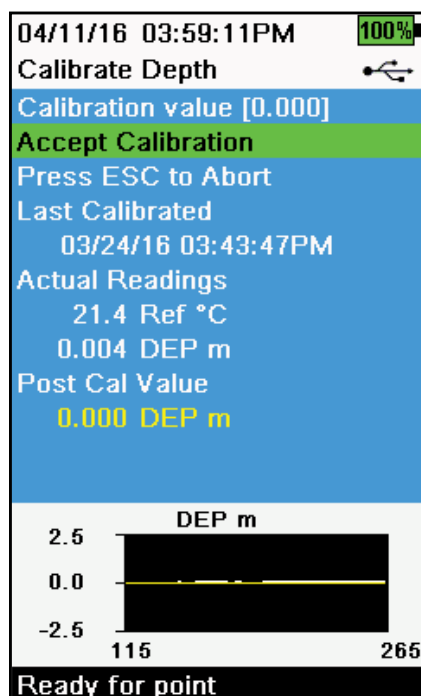



Figure 33 Calibrate Barometer

Barometer calibration

1. Push the  key, then select **Barometer**.
2. Select **Calibration value** then enter the correct “true” barometric pressure.

NOTE: The measurement units during calibration are dictated by what is enabled in the sensor setup menu. Be sure to enter in the correct units.

- BP in mmHg=25.4 x BP inHg
- BP in mmHg=0.750062 x BP mb
- BP in mmHg=51.7149 x BP psi
- BP in mmHg=7.50062 x BP kPa
- BP in mmHg=760 x BP atm

3. Select **Accept Calibration** (Figure 33). “Calibration successful!” will be displayed in the message area.

Dissolved oxygen

ODO calibration requires the current “true” barometric pressure. Make sure that the barometer is reading accurately and recalibrate the barometer as necessary.

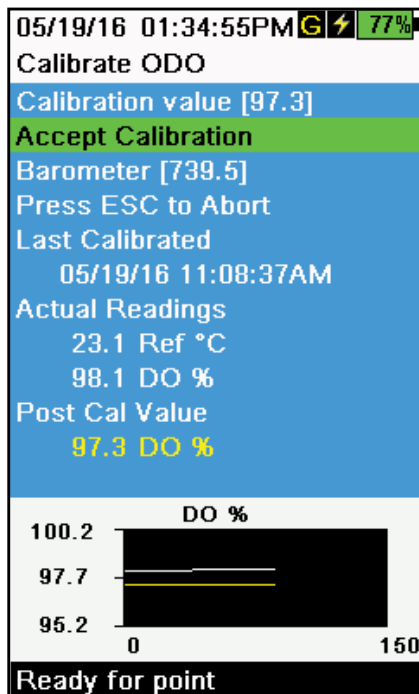

Figure 34 Calibrate DO%

DO% and DO% local - water saturated air calibration

NOTE: This method calibrates the instrument’s DO% measurement or DO% Local measurement if DO% local is enabled in the sensor setup menu.

NOTE: Calibrating in DO% or DO% local automatically calibrates the mg/L and ppm measurement. There is no reason to calibrate both parameters. For both ease of use and accuracy, we recommend that you calibrate DO% or DO% Local and not mg/L.

1. Place a small amount of clean water (1/8 inch) into the calibration cup.
2. Make sure there are no water droplets on the ODO sensor cap or temperature sensor.
3. Attach the sensor guard to the bulkhead and carefully place the guard/sensor into the calibration cup. Partially tighten the calibration cup to the bulkhead.

NOTE: Do not fully tighten the calibration cup to the bulkhead. Atmospheric venting is required for accurate calibration.

NOTE: Make sure the ODO and temperature sensors are not immersed in water.

4. Turn the instrument on and wait approximately 5 to 15 minutes for the air in the storage container to be completely saturated with water.
5. Push the  key, then select **ODO**. Select **DO%**. This will calibrate the instrument’s DO% measurement or DO% Local measurement if DO% Local is enabled in the sensor setup menu.
6. Observe the actual measurement readings for stability (white line on graph shows no significant change for 40 seconds), then select **Accept Calibration** (Figure 34). “Calibration successful!” will be displayed in the message area.

NOTE: If you see a calibration error message, verify the barometer reading and inspect the sensor cap. Clean and/or replace the sensor cap as needed.

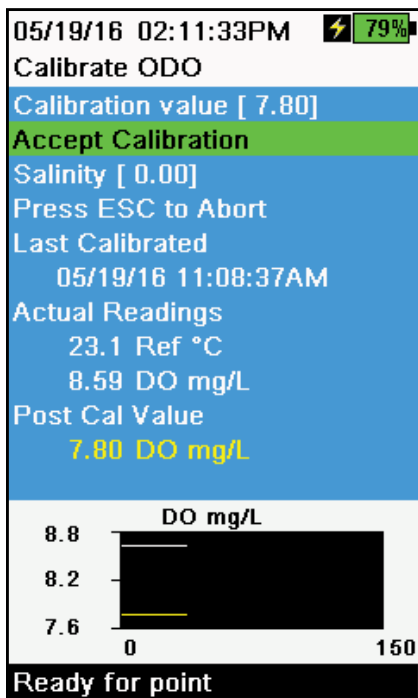

Figure 35 Calibrate DO mg/L

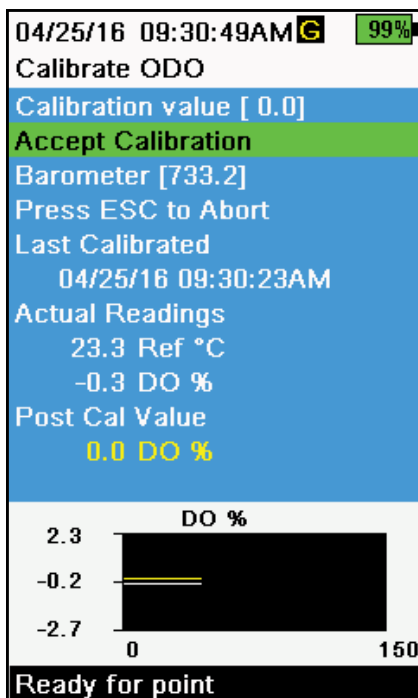



Figure 36 Calibrate DO zero point

DO mg/L calibration

1. Place the ODO and conductivity/temperature sensor into a water sample that has been titrated by the Winkler method to determine the dissolved oxygen concentration in mg/L.
2. Push the  key, then select **ODO**. Select **DO mg/L**.
3. Select **Calibration value**.
4. Enter the dissolved oxygen concentration of the sample in mg/L.
5. Observe the actual measurement readings for stability (white line on graph shows no significant change for 40 seconds), then select **Accept Calibration** (Figure 35). "Calibration successful!" will be displayed in the message area.
6. Rinse the bulkhead and sensors in clean water then dry.

DO zero point calibration

1. Place the ODO and Conductivity/Temperature sensors in a solution of zero DO.

NOTE: A zero DO solution can be made by dissolving approximately 8-10 grams of sodium sulfite into 500 mL of tap water. Mix the solution thoroughly. It may take the solution 60 minutes to be oxygen-free.
2. Push the  key, then select **ODO**. Select **Zero**.
3. Observe the actual measurement readings for stability (white line on graph shows no significant change for 40 seconds), then select **Accept Calibration** (Figure 36). "Calibration successful!" will be displayed in the message area.
4. Thoroughly rinse the bulkhead and sensors in clean water then dry.
5. Perform a DO % water-saturated air calibration after performing a zero point calibration.

pH/ORP

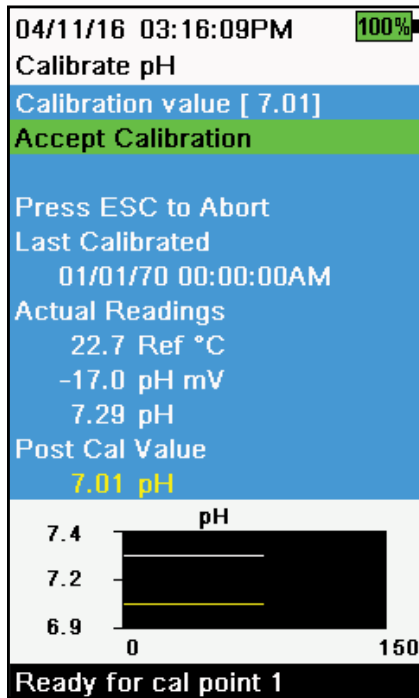



Figure 37 Calibrate pH 1-point

pH calibration 1-point

NOTE: If performing a 1-point calibration, use buffer 7 (6.86) as your calibration point for highest accuracy.

NOTE: Observe the pH mV readings during calibration to understand the condition and response of the pH sensor. In buffer 7, pH mVs should be between -50 and +50. In buffer 4, the mVs should be a +165 to 185 away from the pH 7 mV value. In buffer 10, the mVs should be a -165 to -185 away from the pH 7 mV value. Ideal slope is -59 mV per pH unit.

1. Perform the [Calibration setup](#).
2. Fill the calibration cup to the appropriate level with pH 7 buffer solution (or 6.86 if using NIST buffers).
3. Carefully immerse the probe end of the sensors into the buffer solution.
4. Push the  key, then select **pH** or **pH/ORP**.

NOTE: If using a pH/ORP sensor, select **pH/ORP**, then **pH**.

5. Allow at least one minute for temperature stabilization. The **Calibration value** will automatically be adjusted based on the selected buffer set and temperature. Alternatively, the Calibration value can be manually entered.
6. Observe the actual measurement readings for stability (white line on graph shows no significant change for 40 seconds), then select **Accept Calibration** (Figure 37). "Ready for cal point 2" will be displayed in the message area.
7. After calibrating to the first point, select **Finish Calibration** for a 1-point calibration or continue on to the 2-3 point calibration procedure.

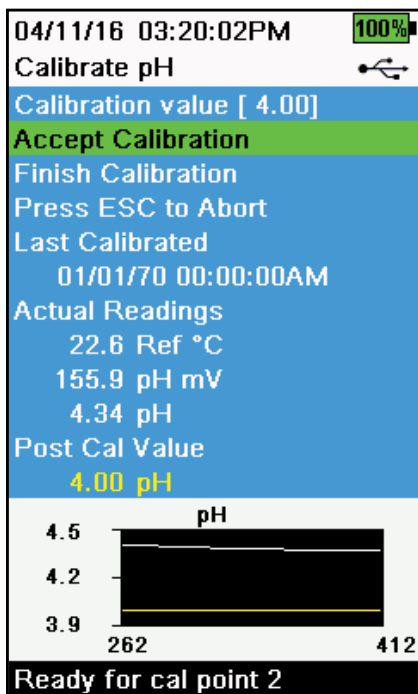

Figure 38 Calibrate pH 2- or 3-point

pH calibration 2- or 3-point

NOTE: If performing a 2- or 3-point calibration, one point should be in buffer 7; however, the calibration points can be in any order.

1. Perform steps 1-7 of the pH calibration 1-point procedure ([1-Point pH Calibration](#)).
2. Rinse the sensor 2-3 times with a small amount of pH 4 or pH 10 buffer solution.
3. Rinse, then fill the calibration cup to the appropriate level with the buffer solution that is the same value (pH 4 or pH 10) used to rinse the sensor.
4. Carefully immerse the sensors into the solution.
5. Allow at least one minute for temperature stabilization. The **Calibration value** will automatically be adjusted based on the selected buffer set and temperature. Alternatively, the Calibration value can be manually entered.
6. Observe the actual measurement readings for stability (white line on graph shows no significant change for 40 seconds), then select **Accept Calibration** (Figure 38). "Ready for cal point 3" will be displayed in the message area.
7. After calibrating to the second point, select **Finish Calibration** for a 2-point calibration or continue with an additional buffer to complete a 3-point calibration. The procedure will automatically finish after calibrating using a third buffer.

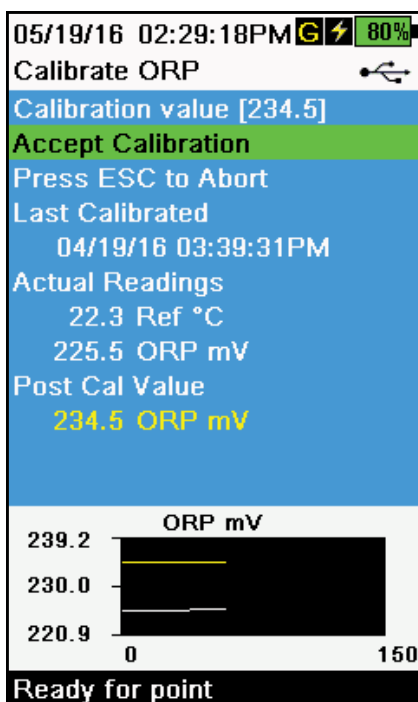



Figure 39 Calibrate ORP

ORP calibration

1. Obtain/prepare a standard with a known oxidation reduction potential (ORP) value.
- NOTE:** YSI recommends Zobell solution.
2. Perform the [Calibration setup \(pH, ORP, ISE, conductivity, turbidity\)](#).
 3. Fill the calibration cup to the appropriate level with standard solution.
 4. Carefully immerse the sensors into the solution.
 5. Push the  key, then select **pH/ORP**, then **ORP**.
 6. Allow the temperature of the standard to stabilize. If using YSI Zobell solution, the **Calibration value** will automatically be adjusted based on the temperature. Alternatively, the Calibration value can be manually entered.
 7. Observe the actual measurement readings for stability (white line on graph shows no significant change for 40 seconds), then select **Accept Calibration** (Figure 39). "Calibration successful!" will be displayed in the message area.

Depth

NOTE: This calibration option is available only if your sonde is equipped with a depth sensor. For the calibration, make sure that the depth sensor is clean and in air, not immersed in any solution. For highest accuracy, keep the bulkhead still and in one position while calibrating.

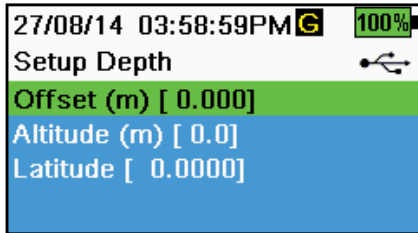

Figure 40 Setup Depth

Setup Depth

⚙️ → **Depth** → **Setup**

Offset: Depth offset can be used if referencing water elevation against a known datum. If a depth offset is entered (in meters), the output value will shift by the value of the offset (Figure 40).

Altitude/Latitude: To compensate for atmospheric pressure based on elevation and gravitational pull, enter the local altitude in meters relative to sea level and latitude in degrees where the EXO handheld is sampling.

Altitude effect: Varying altitudes cause approximately 90 mm change from sea level to 8000 m. A 100 m change causes 1.08 mm of change to the readings.

Latitude effect: Varying latitudes cause a 200 mm change in depth from equator to pole.

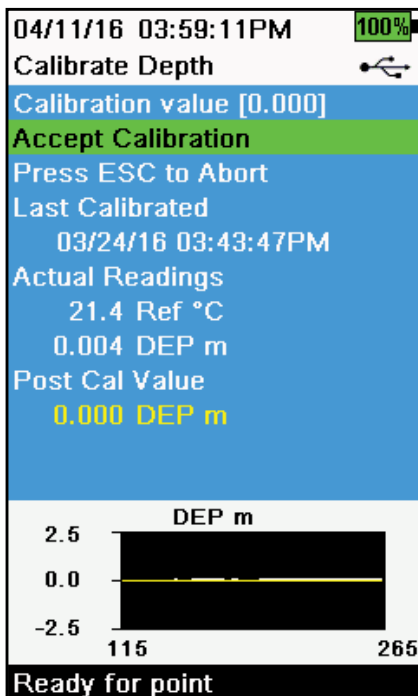



Figure 41 Calibrate Depth

Depth calibration

1. If applicable, enter the depth offset, altitude, and latitude (Figure 40).

NOTE: Depth offset allows you to set the depth measurement to something other than zero. If the depth offset is used, the depth measurement will be adjusted by the offset after calibration. Enter the altitude and latitude of your sampling location to increase the accuracy of your depth measurement.

2. Push the  key, then select **Depth**.
3. Observe the actual measurement readings for stability (white line on graph shows no significant change for 40 seconds), then select **Accept Calibration** (Figure 41). "Calibration successful!" will be displayed in the message area.

Turbidity calibration 1-, 2- or 3-point

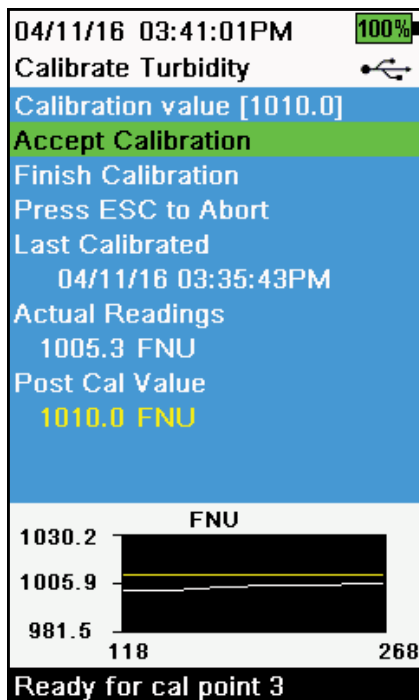



Figure 42 Calibrate Turbidity

NOTE: The sensor guard must be installed for the turbidity sensor calibration.

NOTE: When performing a turbidity calibration, the first point must be zero. Select **Calibration Value** and enter 0.00.

1. Perform the [Calibration setup](#). Rinse the sensor 2-3 times with a small amount of 0 FNU (NTU) standard.
2. Fill the calibration cup to the appropriate level with 0 FNU (NTU) standard (clear deionized or distilled water is suitable). Immerse the sensors into the water.

NOTE: With the calibration cup empty (i.e. no sensor guard or sensors), filling the calibration cup to line 1 will provide a sufficient amount of solution for calibration.

3. Push the  key, then select **Turbidity**.
4. Select **Calibration Value** and enter 0.00.
5. Observe the data points readings for stability with the 0 FNU (NTU) standard (white line on graph shows no significant change for 40 seconds), then select **Accept Calibration**. "Ready for cal point 2" will be displayed in the message area.
6. Select **Finish Calibration** to complete a 1-point calibration or continue for the 2- or 3-point calibration.
7. Rinse the sensors, calibration cup, and sensor guard 2-3 times with a small amount of standard #2. Discard the standard after each rinse.
8. Fill the calibration cup to the appropriate level with standard #2. Immerse the sensors in the second calibration standard.
9. Select **Calibration Value** and enter the value of the second calibration standard.
10. Observe the actual measurement readings for stability (white line on graph shows no significant change for 40 seconds), then select **Accept Calibration** (Figure 42). "Ready for cal point 3" will be displayed in the message area.
11. Select **Finish Calibration** to complete a 2-point calibration or continue for the 3-point calibration.
12. Rinse the sensors, calibration cup, and sensor guard 2-3 times with a small amount of standard #3. Discard the standard after each rinse.
13. Fill the calibration cup to the appropriate level with standard #3. Immerse the sensors in the third calibration standard.
14. Select **Calibration Value** and enter the value of the third calibration standard.
15. Observe the data points readings for stability, then select **Finish Calibration**. "Calibration successful!" will be displayed in the message area.
16. Rinse the sensors in clean water then dry.

ISEs: Ammonium, Nitrate, & Chloride

Before performing the calibration, review [Calibration setup](#).

The ISE sensors can be calibrated to one, two or three points. A 2-point calibration without chilling a third calibration solution is extremely accurate and is the preferred method. However, if there is a large temperature variation during sampling, a chilled third calibration point is recommended.

Higher calibration accuracy can be obtained if the standards used have a least one order of magnitude difference between them. For example, 1 mg/L and 10 mg/L or 10 mg/L and 100 mg/L.

mV information for the ISE calibration

Ammonium mV values

- NH_4 1 mg/L = 0 mV +/- 20 mV (new sensor only)
- NH_4 100 mg/L = 90 to 130 mV > 1 mg/L mV value
- The mV span between 1 mg/L and 100 mg/L values should be \approx 90 to 130 mV.
The slope should be 45 to 65 mV per decade.

Nitrate mV values

- NO_3 1 mg/L = 200 mV +/- 20 mV (new sensor only)
- NO_3 100 mg/L = 90 to 130 mV < 1 mg/L mV value
- The mV span between 1 mg/L and 100 mg/L values should be \approx 90 to 130 mV.
The slope should be -45 to -65 mV per decade.

Chloride mV values

- Cl 10 mg/L = 225 mV +/- 20 mV (new sensor only)
- Cl 1,000 mg/L = 80 to 130 mV < 10 mg/L mV value
- The mV span between 10 mg/L and 1000 mg/L values should be \approx 80 to 130 mV.
The slope should be -40 to -65 mV per decade.

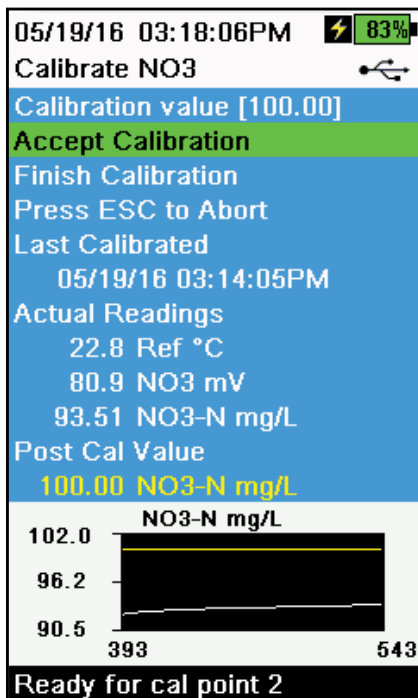



Figure 43 Calibrate ISE

ISE calibration 3-point

1. Perform the [Calibration setup](#). Rinse the sensor 2-3 times with a small amount of standard #1.

NOTE: It is best to calibrate in order of increasing concentration (e.g. if using 1 mg/L and 100 mg/L standards, calibrate with 1 mg/L first).

2. Push the  key, then select the applicable ISE sensor.
3. Carefully immerse the sensors into a solution of standard #1.
4. Allow the temperature of the standard to stabilize, then select **Calibration value**. Enter the calibration value that corresponds to standard #1.
5. Observe the actual measurement readings for stability (white line on graph shows no significant change for 40 seconds), then select **Accept Calibration** (Figure 43). "Ready for cal point 2" will be displayed in the message area.
6. Select **Finish Calibration** to complete a 1-point calibration. Otherwise, continue the calibration procedure to complete at least a 2-point calibration.

NOTE: A 2-point calibration is extremely accurate and is the preferred method.

7. Rinse the sensor 2-3 times with a small amount of standard #2. Discard the standard after rinsing.
8. Carefully immerse the sensors into a fresh solution of standard #2.
9. Allow the temperature of the solution to stabilize then select **Calibration value**. Enter the calibration value that corresponds to standard #2.
10. Observe the actual measurement readings for stability (white line on graph shows no significant change for 40 seconds), then select **Accept Calibration** (Figure 43). "Ready for cal point 3" will be displayed in the message area.
11. Select **Finish Calibration** to complete a 2-point calibration. Otherwise, continue the calibration procedure to complete a 3-point calibration.

NOTE: To calibrate with a chilled third standard, see [Chilled third calibration point on the next page](#).

12. Rinse the sensor 2-3 times with a small amount of standard #3. Discard the standard after rinsing.
13. Carefully immerse the sensors into a fresh solution of standard #3.
14. Allow the temperature of the solution to stabilize then select **Calibration value**. Enter the calibration value that corresponds to standard #3.
15. Observe the actual measurement readings for stability (white line on graph shows no significant change for 40 seconds), then select **Finish Calibration**. "Calibration successful!" will be displayed in the message area.

Chilled third calibration point

The 3-point calibration method assures maximum accuracy when the temperature of the media to be monitored cannot be anticipated. If you must perform a chilled 3-point calibration, the following procedure requires one portion of the high concentration calibration solution and two portions of the low concentration calibration solution.

The high concentration solution and one of the low concentration solutions should be at ambient temperature. The other low concentration solution should be chilled to less than 10 °C (50 °F) to prior calibration point.

[See ISE calibration 3-point on previous page.](#)

1. When "Ready for cal point 3" is displayed in the message area during ISE calibration, place the proper amount of chilled 1 mg/L standard (10 mg/L for the chloride) into a clean, dry or pre-rinsed calibration cup.
2. Carefully immerse the sensor into the solution. Allow for temperature equilibration. If necessary, select **Calibration value** to manually enter the standard #3 value.
3. Once the readings are stable, select **Accept Calibration**. "Calibration successful!" will be displayed in the message area.

fDOM & Total Algae (TAL) Sensors

For more information on fDOM and Total Algae (TAL) Calibration, please review the full EXO User Manual.

1. Push the  key, then select **fDOM** or **TAL**

Wipe Sensors

→ Wipe Sensors

Highlight **Wipe Sensors** on the Calibration menu and push the  key to wipe the sonde sensors.

NOTE: An EXO Central Wiper must be installed to activate this command.

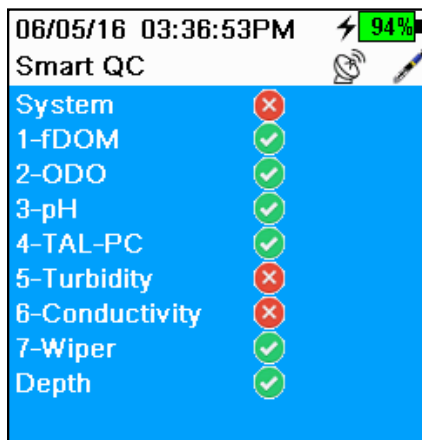





Figure 44 Smart QC

Smart QC

→ Smart QC

The Smart QC menu indicates the quality of calibrations on installed sensors by displaying a , a , or a  beside each sensor name.



indicates a successful calibration.



indicates a poor or unsuccessful calibration.



indicates a successful calibration that is nearing the edge of acceptable limits.



Perform the recommended cleaning and maintenance procedure on any flagged sensors and recalibrate.

NOTE: Collecting data using sensors flagged with a red Smart QC Score is not recommended.

NOTE: SmartQC scores are indicative of sensor quality at the time of calibration.

EXO Handheld Data Menu

Data menu

Push the  key to access the Data menu (Figure 45). Highlight a sub-menu then push the  key to view sub-menu options.

Use the Data menu to view data recorded via the Handheld dashboard.

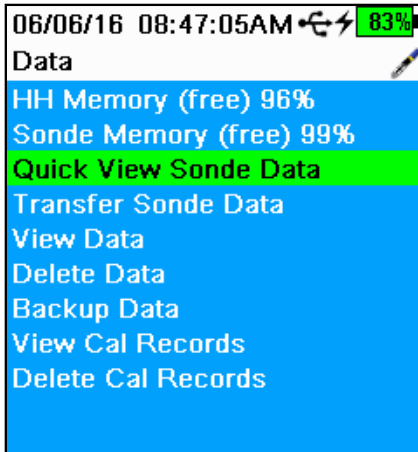

Figure 45 Data Menu

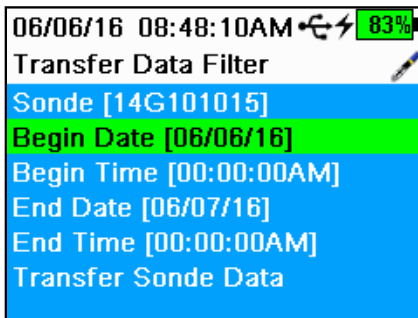

Figure 46 Transfer Data Filter

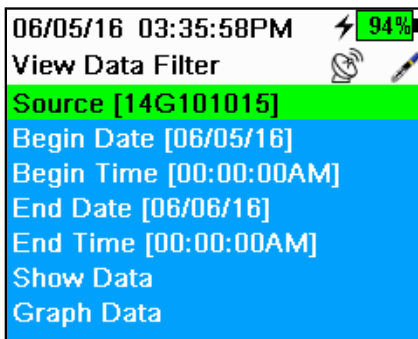

Figure 47 View Data Filter

Use the Data menu to

- View available handheld memory
- View available sonde memory
- View handheld and sonde data
- Transfer data files from sonde to Handheld
- Delete data
- Backup data to USB
- View calibration records
- Delete calibration records

Quick View Sonde Data

 → **Quick View Sonde Data**

View logged data that has been selected in the data filter settings. Use the ▲ and ▼ arrow keys to scroll through rows of individual data sets. Use the ◀ and ▶ arrow keys to view additional data for each data set.

Transfer Data Filter

 → **Transfer Sonde Data**

Data recorded via a sonde deployment is saved on the sonde's internal memory. Use the Transfer Sonde Data menu to transfer sonde data to the EXO handheld. Enter the desired filter criteria, then select **Transfer Sonde Data** to transfer data from the sonde.

View Data Filter

 → **View Data**

Use the View Data Filter menu to view and graph logged data over a specified time period. Enter the desired filter criteria, then select **Show Data** or **Graph Data** to view the tabular or graphical data. If necessary, use the ▲ and ▼ arrow keys to scroll through the data.

Source: View data recorded on the Handheld or sonde.

Site: View data from one site or all sites.

Begin/End: View data within specified date and time ranges.

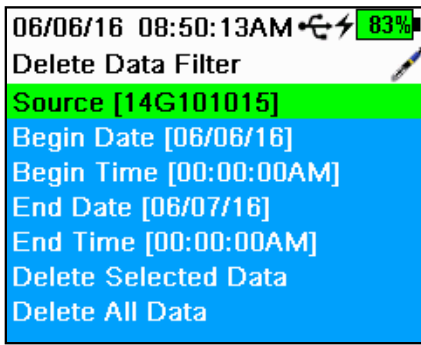

Figure 48 Delete Data Filter

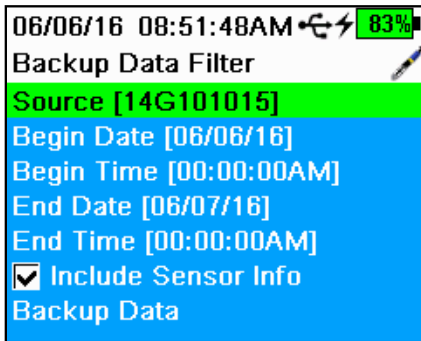

Figure 49 Backup Data Filter



Figure 50 Micro USB Female Controller

Delete Data

→ Delete Data

Use the Delete Data Filter menu to select specific data to be deleted from memory. Enter the desired filter criteria, then select **Delete Selected Data** to *permanently* delete the data (Figure 48).

Select **Delete All Data** to *permanently* delete *all* logged data from the EXO Handheld.

Backup Data

→ Backup Data

A USB female to micro USB male adapter is included with the EXO Handheld to directly backup files from the handheld to a standard USB storage device. The data is exported as a CSV file.

Enter the desired filter criteria then connect the handheld to the USB storage device using the supplied adapter. Select **Backup Data** to export the data to an USB storage device (Figure 49 and Figure 50).

NOTE: The USB storage device must be formatted as FAT32, not NTFS or exFAT. The handheld will only support FAT32.

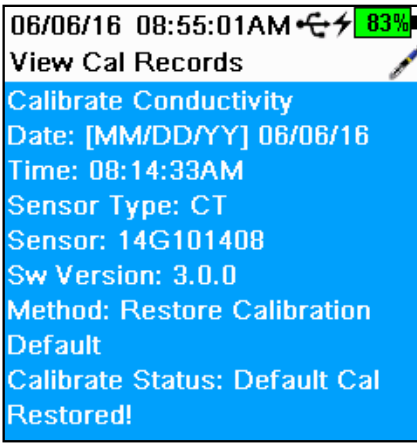

Figure 51 View Calibration Records

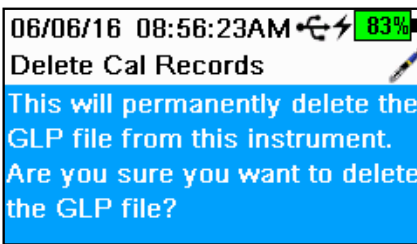

Figure 52 Delete Records

View Calibration Records

→ View Cal Records

Use this menu to view all calibration records stored in memory. Use the ▲ and ▼ arrow keys to scroll through different calibration records.

Calibration information includes the sensor type, the calibration date and time, and the calibration status. Records may also contain optional information, such as User ID and Sonde ID.

WARNING: The calibration record memory is finite and will overwrite the oldest record once the memory is full.

NOTE: Periodically upload calibration records to a PC to retain a permanent copy.

Delete Calibration Records

→ Delete Cal Records

Use this menu to delete only the Calibration Record file. Sensor calibrations and logged data will not be affected.

Highlight 'Yes' or 'No' and push the  key to confirm the selection.

Taking Sampling Measurements

For the highest accuracy, calibrate the instrument before taking measurements ([Calibration](#)).

1. Create a Site List for logged data (if applicable). ([Logging](#)).
2. Set the logging method (single or continuous) ([Logging](#)).
3. Set the Auto Stable parameters (if applicable) ([Auto Stable](#)).
4. Verify that sensors and/or port plugs are correctly installed in all sonde ports.
5. Install the sensor guard
6. Insert the sensors into the sample.

NOTE: Make sure to submerge the sensors completely. If using a depth sensor, submerge to where the cable assembly attaches to the sonde.

7. Move the bulkhead of the sonde in the sample to release any air bubbles.
8. Wait for the sensor/s to stabilize in the sample.
9. On the Dashboard screen, press  to begin logging (single or continuous) ([Logging](#)).

NOTE: An option to change the Site appears once  is pressed on the Dashboard screen to begin logging, as does an option to wipe sensors prior to taking a reading if a wiper is installed.

Xylem |'zīləm|

- 1) The tissue in plants that brings water upward from the roots;
- 2) a leading global water technology company.

We're a global team unified in a common purpose: creating advanced technology solutions to the world's water challenges. Developing new technologies that will improve the way water is used, conserved, and re-used in the future is central to our work. Our products and services move, treat, analyze, monitor and return water to the environment, in public utility, industrial, residential and commercial building services settings. Xylem also provides a leading portfolio of smart metering, network technologies and advanced analytics solutions for water, electric and gas utilities. In more than 150 countries, we have strong, long-standing relationships with customers who know us for our powerful combination of leading product brands and applications expertise with a strong focus on developing comprehensive, sustainable solutions.

For more information on how Xylem can help you, go to www.xylem.com



YSI, a Xylem brand
1725 Brannum Lane
Yellow Springs, OH 45387
Tel +1.800.897.4151
Fax +1.937.767.9353
www.xylem.com

EXO is a trademark of Xylem or one of its subsidiaries.
© 2020 Xylem, Inc. 603789REF 0420



Bluetooth® is a trademark of SIG Inc.
Xenoy™ is a trademark of SABIC Plastics.