

aeroqual<sup>®</sup>

# AQM65

## USER GUIDE



Aeroqual Limited  
460 Rosebank Road, Avondale  
Auckland, New Zealand  
t +64 9 623 3013  
f +64 9 623 3012  
e [technical@aeroqual.com](mailto:technical@aeroqual.com)  
[aeroqual.com](http://aeroqual.com)

# Table of Contents

1	Description of AQM 65.....	7
1.1	Gas Modules .....	8
1.1.1	Gas Module design .....	8
1.1.2	O <sub>x</sub> / O <sub>3</sub> system for measuring NO <sub>2</sub> .....	10
1.1.3	Gas flow through modules .....	13
1.2	Particulate matter (TSP, PM10, PM2.5, PM1.0) modules .....	15
1.2.1	Particle Monitor modules.....	15
1.2.2	Nephelometer optical module: 80180 upgraded to 82850 .....	17
1.2.3	Particle Profiler modules (and upgrade to profiler pump module) .....	19
1.2.4	Comparison between the Particle Monitor and the Particle Profiler .....	20
1.3	Optional external sensors and auxiliary modules .....	21
1.3.1	Temperature and Humidity Sensor .....	22
1.4	Thermal management system and system manager module.....	22
1.5	Interfacing with the AQM 65 using Connect and Cloud .....	24
1.5.1	Aeroqual Connect.....	24
1.5.2	Aeroqual Cloud.....	25
1.6	Quick start guide .....	27
2	Set-up .....	28
2.1	Unpacking .....	29
2.2	Initial assembly and powering the AQM 65 for the first time.....	29
2.2.1	Wire AC mains power and initial start-up.....	30
2.2.2	Attach PM inlet .....	31
2.2.3	Attach gas inlet.....	34
2.2.4	Wire external third party sensors .....	36
2.3	Set up MOXA G3111 HSPA modem for remote communication.....	37
2.4	Re-packing and transport.....	38
3	Connect Software .....	39
3.1	Connecting to the AQM 65 for the first time.....	40
3.2	Options for connecting to the AQM 65.....	41
3.2.1	Direct WIFI .....	42
3.2.2	Direct connection using Ethernet cable .....	42
3.2.3	Connecting over a local area connection (LAN) .....	42
3.2.4	Connecting using a cellular modem.....	43
3.3	Resetting the communication settings back to factory settings .....	45
3.4	Apps for instrument control and calibration.....	46
3.4.1	Manage Data app.....	46
3.4.1.1	Charts.....	47
3.4.1.2	Table .....	47
3.4.1.3	Download data .....	48
3.4.1.4	Manual sync .....	49
3.4.2	Service and Calibration app.....	50
3.4.3	Diagnostics and Advanced.....	51

3.4.4	Checking Instrument licences in the About Screen .....	52
3.4.5	Setting measurement units to ppm, ppb, $\mu\text{g m}^{-3}$ or $\text{mg}^{-3}$ , degrees °C or °F .....	53
3.4.6	Journal .....	54
3.5	User permission types: Administrator, Engineer, User and how to create users with secure credentials .....	55
3.5.1	How to create new users and secure the AQM 65 .....	55
3.6	Aeroqual Cloud software features .....	56
3.6.1	Set up text (SMS) and Email alerts .....	56
3.6.2	Create Organisations, networks, and users in Aeroqual Cloud .....	57
4	Maintenance and service .....	58
4.1	Safety requirements .....	58
4.2	Gas flow meters and flow measurement .....	59
4.3	AQM 65 Service mode and using the Journal to document service .....	60
4.3.1	Manual service mode .....	60
4.3.2	Journal .....	60
4.4	List of maintenance procedures .....	61
4.4.1	Tools required for regular service and maintenance .....	61
4.4.2	Replace gas sample inlet filter .....	62
4.4.3	Measure and adjust AQM 65 inlet flowrate and module flow rates .....	63
4.4.3.1	Measure main gas inlet flow rate .....	63
4.4.3.2	Measure the flow rate of the individual modules .....	64
4.4.3.3	Adjust the AQM 65 inlet flow rate and replacement of the gas sample pump. ....	65
4.4.4	Replace filter on Particle Monitor or Particle Profiler .....	66
4.4.5	Flow check and flow adjustment of the Particle Monitor and Particle Profiler .....	67
4.4.5.1	Using the buffer chamber when checking the flow of the Particle Profiler .....	68
4.4.5.2	Flow adjustment of Particle Monitor .....	69
4.4.5.3	Flow adjustment of Particle Profiler .....	70
4.4.6	Leak check Particle Monitor and Particle Profiler .....	71
4.4.6.1	Leak check a Particle Monitor .....	71
4.4.6.2	Leak check a Particle Profiler .....	72
4.4.7	Zero calibration check and flow check of Particle Module .....	73
4.4.7.1	Check zero baseline of Particle Monitor .....	73
4.4.7.2	Check the auto zero calibration flow rate of the Particle Monitor .....	74
4.4.7.3	Module settings and diagnostics for the 80180 and 82850 particle monitor .....	76
4.4.7.4	Changing the sharp cut cyclone in the software 80180 and 82850 optical module..	78
4.4.7.5	Check the zero baseline of the Particle Profiler .....	79
4.4.8	Clean the Particle Monitor TSP inlet, particle trap and cyclone .....	79
4.4.9	Replace pumps in pump module .....	80
4.4.10	Leak check gas module .....	81
4.4.11	Add, remove or replace a gas module .....	82
4.4.11.1	Removing a module without replacing it .....	83
4.4.11.2	Replacing a module with another of the same type .....	83
4.4.11.3	Adding a new module .....	84
4.4.12	Thermal management system, maintenance and troubleshooting .....	85
4.4.12.1	Changing the internal set point temperature .....	85

4.4.12.2	Loss of thermal control .....	86
4.4.12.3	Clean TMS cassette and condenser fins .....	87
4.4.12.4	Check TMS compressor gas pressure and re-fill .....	89
4.5	Factory calibration of Particle Monitor and Particle Profiler .....	95
4.6	Service frequency guidelines .....	95
5	Gas module calibration .....	97
5.1	Calibration frequency .....	98
5.2	Guidelines for purchasing calibration gas cylinders and gas regulators.....	99
5.2.1	Purchasing calibration gas: recommended cylinder concentrations and sizes. ....	99
5.2.2	Cylinder of certified zero air and certified CO <sub>2</sub> for CO <sub>2</sub> calibration .....	100
5.2.3	Considerations for gas cylinder size .....	100
5.3	Calibration safety .....	102
5.4	Aeroqual portable calibration systems: AirCal 1000, and AQM O3CAL.....	102
5.5	Aeroqual integrated calibration system AirCal 8000 .....	104
5.6	Calibration accessories: tubing, fittings, gas regulator. ....	105
5.6.1	Inert fluoropolymer tubing for module calibration .....	105
5.7	Calibration procedure.....	107
5.7.1	Site inspection and instruments pre-checks .....	107
5.7.2	Using the AQM 65 Journal and the calibration template to log calibration details.....	107
5.7.3	Overall calibration workflow: .....	108
5.7.3.1	New NO <sub>2</sub> calibration procedure overview .....	109
5.7.4	Instrument checks before starting calibration .....	112
5.7.5	Setting up calibration equipment.....	113
5.7.5.1	Zero calibration using the AirCal 1000.....	113
5.7.5.2	Span calibration using the AirCal 1000.....	114
5.7.5.3	Span calibration using the AQM O3CAL ozone calibrator .....	115
5.7.5.4	Zero and span calibration using the AirCal 8000 .....	116
5.7.5.5	Calibration section of Connect / Cloud software .....	117
5.7.6	Perform the zero calibration .....	119
5.7.6.1	Wait for the module response to stabilise towards zero air .....	119
5.7.6.2	Decide if a zero offset adjustment is required .....	120
5.7.6.3	Upload the new offset and check the offset has been applied correctly.....	120
5.7.7	Perform the span calibration .....	121
5.7.7.1	Choose your span gas concentration.....	121
5.7.7.2	Wait for the module response to stabilise towards the span gas.....	122
5.7.7.3	Decide if a gain adjustment is required .....	123
5.7.7.4	Calculate a new gain, and decide if the gain should be applied .....	123
5.7.7.5	Summary.....	123
5.7.8	Record your results in the Journal .....	124
5.7.9	Pack up and final instrument checks, schedule the next calibration.....	124
6	Particle Monitor calibration .....	125
6.1	Factory Servicing .....	125
6.2	Field Calibration .....	125
6.3	Steps to perform a K factor correction .....	126
7	Appendices .....	128

Appendix 1 Troubleshooting.....	128
Appendix 2 AQM 65 dimensions and weight.....	131
Appendix 3 DC Power consumption of the AQM 65 .....	132
Appendix 4 CO2 module calibration .....	134
Appendix 5 AQM 65 site installation and commissioning with mounting examples.....	136
Appendix 6 Gas calibration systems from other suppliers .....	141
Appendix 7 HTTP Web API .....	143
Appendix 7 Calibration results template .....	144
8 Copyright.....	152
9 Compliance .....	152
10 Warranty.....	152

# User Guide Revision History

**Current version:** 2.2

**Description:** User guide for AQM 65

<b>Date</b>	<b>Revision number</b>	<b>Description of change</b>	<b>Affected Sections</b>
October 2018	2.1	Description of Ox/O3 system Updated Calibration SOP Description of Nephelometer optical engine update Profiler leak check SOP updated Update description of key software features	All
June 2017	2.0	Updated	All
March 2015	1.0	New User Guide	All

# Alternative sources of information and help

In addition to this User Guide, Aeroqual hosts a You Tube channel which we are constantly updating.

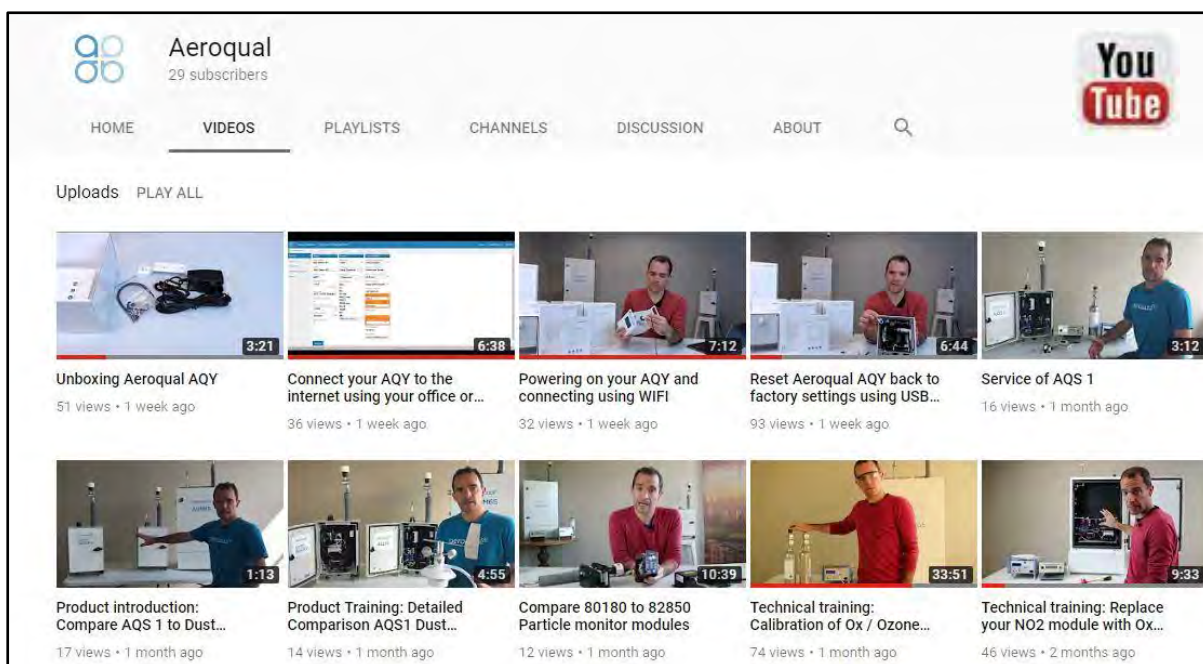

Search for Aeroqual on YouTube or follow this link:



<https://www.youtube.com/channel/UC4eyICTCnaiBipTjbAvlyWw>

The training website contains a comprehensive document library of technical notes and service and calibration templates to download and print. The training website has detailed descriptions of service activities and calibration and installation examples and is updated regularly. Video tutorials are featured heavily. Go to [training.aeroqual.com](http://training.aeroqual.com). Contact [technical@aeroqual.com](mailto:technical@aeroqual.com) to receive access.



The online training website has sections on all the key topics: [training.aeroqual.com](http://training.aeroqual.com)

Where possible, references to online material will provided throughout this user guide

	Online reference	<a href="http://training.aeroqual.com">training.aeroqual.com</a>
	Online video	Youtube channel Aeroqual

Contact your distributor in your local country for initial technical support. If local technical support is unsatisfactory contact the Aeroqual support team: [technical@aeroqual.com](mailto:technical@aeroqual.com).

# 1 Description of AQM 65

The Aeroqual AQM 65 is a compact air quality station designed for precise measurement of ambient pollution and environmental conditions.

The AQM 65 platform is modular, each measurement parameter is selected by the user and added to the platform as an individual measurement module. An AQM 65 can be configured with 1- 6 gas modules as well as particulate and weather sensors.

A typical customised configuration might include ozone (O<sub>3</sub>), nitrogen dioxide (NO<sub>2</sub>), carbon monoxide (CO), sulfur dioxide (SO<sub>2</sub>) PM10, and PM2.5, temperature, humidity, wind speed and direction.

Measurement modules can easily be added, removed or replaced after the AQM 65 has been installed in the field.

The AQM 65 is fully weather proof (IP 65) and houses a power module, thermal management system, embedded PC running Aeroqual Connect software and the user selected analyser modules.

Users can make use of Aeroqual's web-based Cloud software services for data storage and management of networks of AQM 65s.

The AQM 65 can be fitted with an optional internal calibration system called the AirCal8000 shown in Figure 1-1

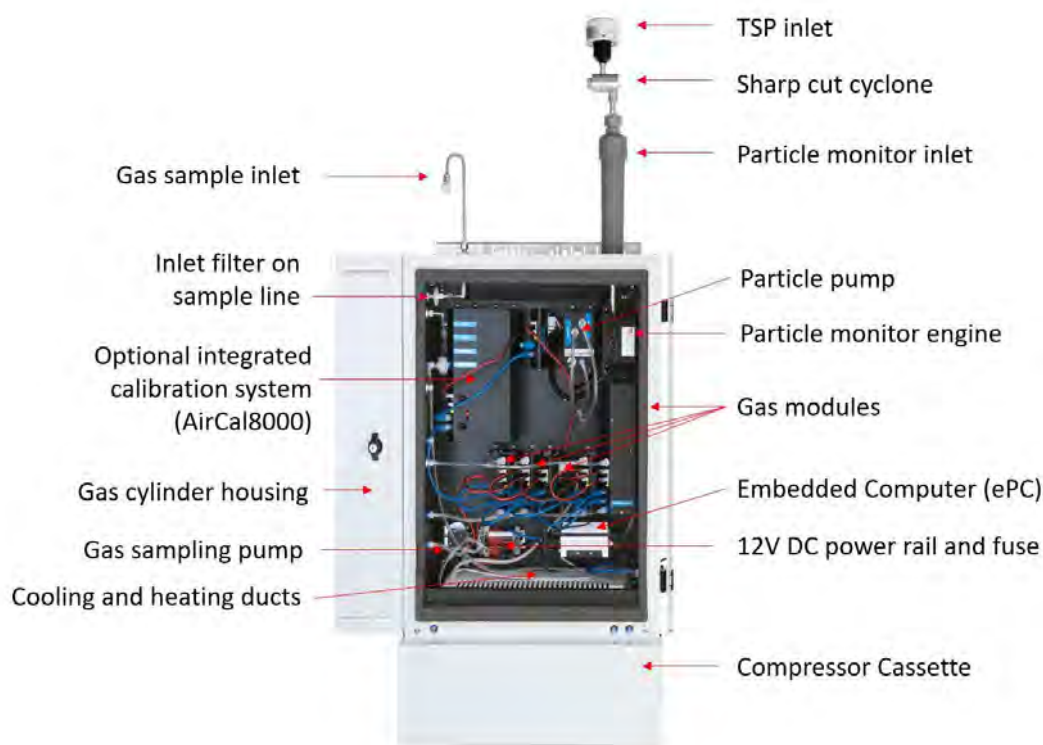

Figure 1-1 AQM 65 with key parts labelled



## 1.1 Gas Modules

Several gas modules are available for integration in to the AQM 65. A full list of the gas modules and module specification is given in Table 1.1 on page 12.

### 1.1.1 Gas Module design

The AQM 65 can be configured with a range of gas modules. Two gas module designs are used in the AQM 65. These two designs are shown schematically in Figure 1-2, a list of which gas modules use which design is given in Table 1-1 on page 12.

- **Direct design:** The gas is passed directly to the sensor continuously
- **Zero switching design:** The module uses a solenoid to switch between a zero path which removes the target gas and creates a “zero” or baseline measurement, and a measurement path which measures the ambient air. The final measurement in ppm is an arithmetic combination of the zero and sample measurement.

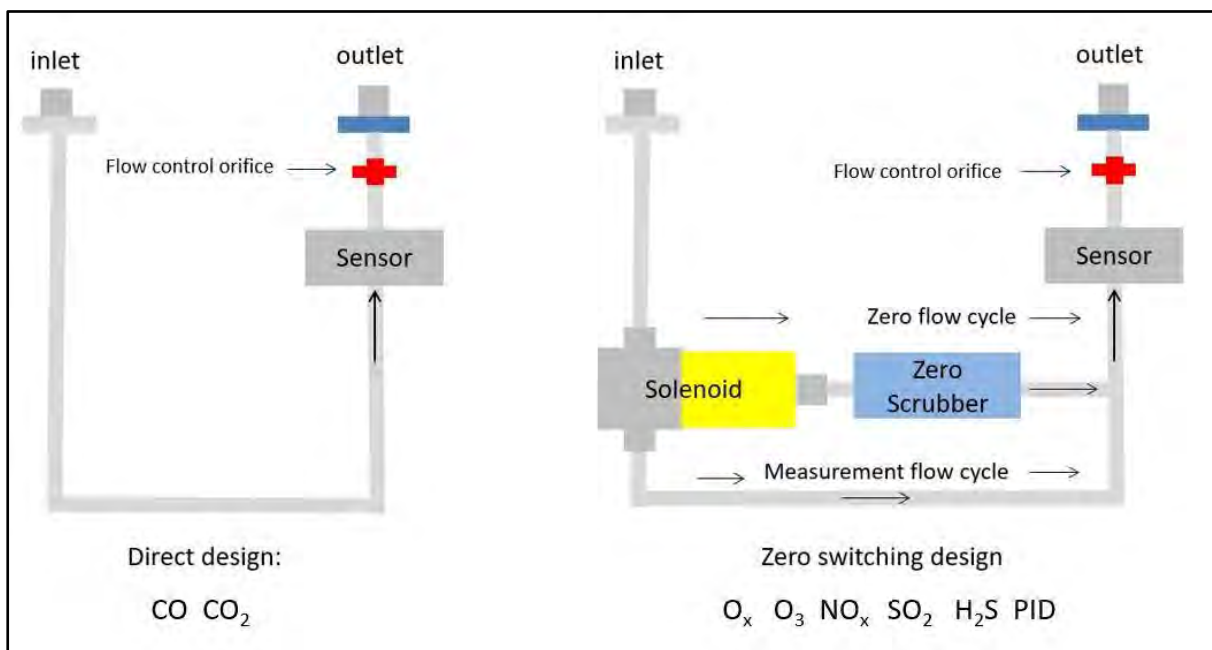

**Figure 1-2 Gas sensor modules are based on two different designs**

Each gas module uses a sensor technology that is most suited to its target gas. For example the Ozone module uses gas sensitive semiconductor (GSS) sensor and the VOC module uses a photo ionisation detector (PID).

The gas flow rate is controlled using a critical orifice, shown in red in Figure 1-2.

A list of which sensor technology is used in each gas module and the flow rate for each module is given in Table 1-1 on page 12

The gas modules come in different sizes, the size of the gas modules varies depending upon the size and number of components used inside the module such as the zero scrubbers for example. The size of each gas module is shown in Figure 1-3

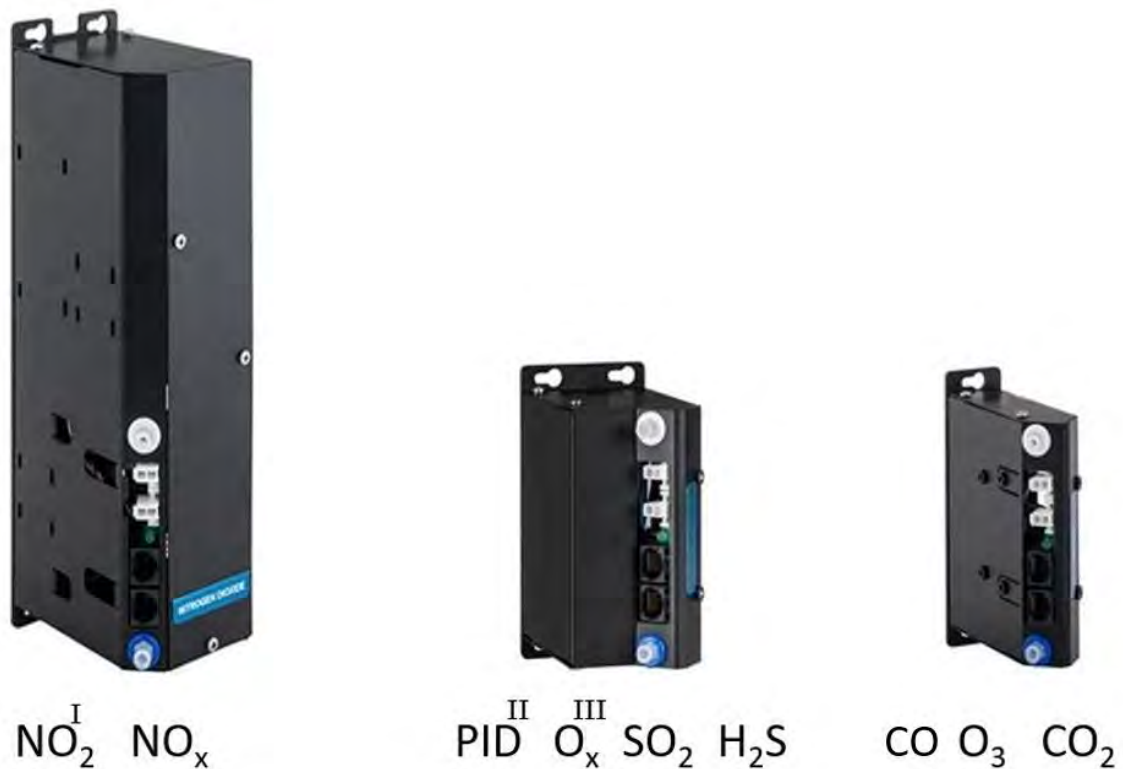

**Figure 1-3 Gas sensor modules come in three different sizes**

I AQM 65's sold before May 2018 use the large size gas module, AQM 65's sold after May 2018 have the Ox/O<sub>3</sub> system for measuring NO<sub>2</sub>. The large NO<sub>2</sub> can be replaced with the Ox module at any time:

II AQM 65's sold after June 2018, use the medium size zero switching PID module, AQM 65's before June 2018 use the small size straight through design for PID.

III The Ox module is used with the O<sub>3</sub> module to calculate NO<sub>2</sub> concentration

Each gas module contains a gas inlet port (white ring) and a gas exhaust port (blue ring). Each module contains two 12 V power connectors to allow the module to be connected to a 12 V power bus. Each module contains two RJ-45 connections to allow the module to be connected to the RS-485 communications bus and each module contains a status LED.



**Figure 1-4 Gas sensor module with key components labelled**

## 1.1.2 O<sub>x</sub> / O<sub>3</sub> system for measuring NO<sub>2</sub>

In May of 2018, an improvement to the way NO<sub>2</sub> was measured was made. This change resulted in a new O<sub>x</sub> module being released. To learn more about it see the video.



**Figure 1-5 Replacing NO<sub>2</sub> module with O<sub>x</sub>/O<sub>3</sub> system for measuring NO<sub>2</sub>**

[www.youtube.com/watch?v=4GS7ey4S-68](http://www.youtube.com/watch?v=4GS7ey4S-68)

The large NO<sub>2</sub> module which measured NO<sub>2</sub> directly has been replaced with a system which uses two modules: a standard Ozone module and the new O<sub>x</sub> module.

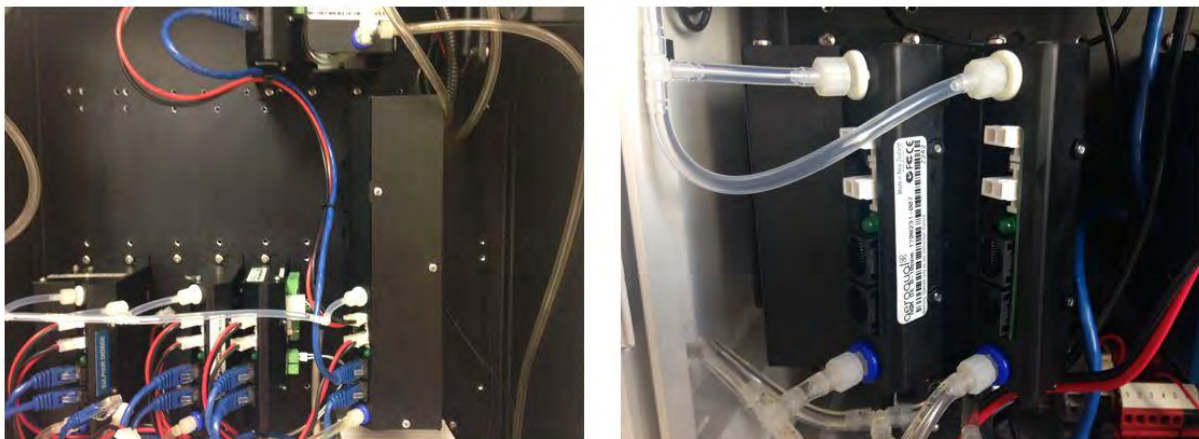

**Figure 1-6 Left: The large size direct NO<sub>2</sub> measurement module, Right: Ox/O<sub>3</sub> system for measuring NO<sub>2</sub>**

The O<sub>x</sub> module is sensitive towards NO<sub>2</sub> and towards O<sub>3</sub>. The Ozone module is very selective towards Ozone only. NO<sub>2</sub> is calculated as follows:

$$\text{NO}_2 = [\text{O}_x] - a[\text{O}_3]$$

The **a** factor represents the sensitivity of the Ox module towards ozone, **a** is calculated during calibration of the O<sub>x</sub>/O<sub>3</sub> system, this is described in detail in 5.7.3.1.

### **Large NO<sub>2</sub> module replacement**

- AQM 65's which have an original O<sub>3</sub> module installed and the original large NO<sub>2</sub> module installed are only required to order an Ox module when replacing the large NO<sub>2</sub> module, this is part number AQM Ox.
- AQM 65's without an O<sub>3</sub> module, need to order an O<sub>3</sub> module and an Ox module when replacing the large NO<sub>2</sub> module, these modules are available under a singlepart number "AQM NO2O3".
- When the original NO<sub>2</sub> module is replaced, the calculated NO<sub>2</sub> channel data can not be polled using the legacy RS-232 protocol, the API must be used to poll the NO<sub>2</sub> channel data.

Module	Range (ppm)	Resolution (ppm)	Sensor <sup>1</sup> Technology	Module Size	Measurement method	Serviceable parts	Module flow rate ml min <sup>-1</sup>	Lower detectable limit (ppm)	Precision	Drift 24 hour	Expected module lifetime
										Zero (ppm)	
										Span % of F.S	
O <sub>3</sub>	0 – 0.5	0.001	GSS	Small	Zero Switching	none	110 - 130	0.001	< 2% of reading or 0.002 ppm	0.001 0.2 %	2 – 3 years
<sup>I</sup> NO <sub>2</sub>	0 – 0.2	0.001	GSS	Large	Zero Switching	none	55 - 65	0.001	< 3% of reading or 0.003 ppm	0.001 0.5 %	2 – 3 years
<sup>II</sup> O <sub>x</sub>	0 – 0.5	0.001	GSE	Medium	Zero Switching	none	55 - 65	0.001	< 2% of reading or 0.002 ppm	0.001 0.2 %	2 – 3 years
NO <sub>x</sub>	0 – 0.5	0.001	GSS	Large	Zero Switching	none	55 - 65	0.001	< 3% of reading or 0.003 ppm	0.001 0.2 %	2 – 3 years
SO <sub>2</sub>	0 – 10.0	0.001	GSE	Medium	Zero Switching	none	55 - 65	0.009	< 3% of reading or 0.003 ppm	0.001 0.2 %	1 – 2 years
CO	0 – 25.0	0.001	GSE	Small	Direct	none	55 - 65	0.040	< 3% of reading or 0.050 ppm	0.02 0.2 %	1 – 2 years
H <sub>2</sub> S	0 - 10	0.001	GSE	Medium	Zero Switching	none	55 - 65	0.012	< 3% of reading or 0.012 ppm	0.001 0.6 %	1 – 2 years
<sup>III</sup> VOC	0 – 0.5	0.001	PID	Medium	Zero Switching	Lamp (6 months)	55 - 65	0.001	< 2% of reading or 0.001 ppm	0.001 1 %	1 – 2 years
<sup>IV</sup> VOC	0 - 20	0.001	PID	Small	Direct	Lamp (6 months)	140 - 160	0.010	< 2% of reading or 0.010 ppm	0.005 0.2 %	1 – 2 years
CO <sub>2</sub>	0 - 2000	1	NDIR	Small	Direct	none	140 - 160	10	< 2% of reading or 10 ppm	1 0.6 %	1 – 2 years

**Table 1-1 Gas Module specification table**

**Sensor Types:** Gas Sensitive Semiconductor (GSS), Gas Sensitive Electrochemical (GSE), Non-dispersive Infra-red (NDIR), Photo Ionization Detector (PID).

**I. In May 2018 the large NO<sub>2</sub> module was replaced with an O<sub>x</sub>/O<sub>3</sub> system for measuring NO<sub>2</sub>**

**II. The O<sub>x</sub> module is used together with the O<sub>3</sub> module to provide a calculated NO<sub>2</sub> measurement**

**III. / IV In June 2018 the small PID module (direct measurement) was replaced with the medium size zero switching PID module.**

**NOTE:** Performance criteria are provided for factory test conditions and may change without notice

### 1.1.3 Gas flow through modules

The gas flow through all of the gas modules is powered by a single diaphragm pump at the bottom left of the enclosure. The vacuum side of the pump is connected to the gas outlet (exhaust) of each module. This is illustrated for a single gas module in Figure 1-7.

The pump pulls sample air through the module and then pushes air out through the exhaust so that the sample air passes through the pump only **after** it has been measured in the module.

There are two different types of tubing material used to handle the gas flow.

- Before the gas reaches the sensor, all of the tubing material is rigid non-reactive PFA.
- After the sample has passed the sensor all of the tubing is flexible R3603 Tygon

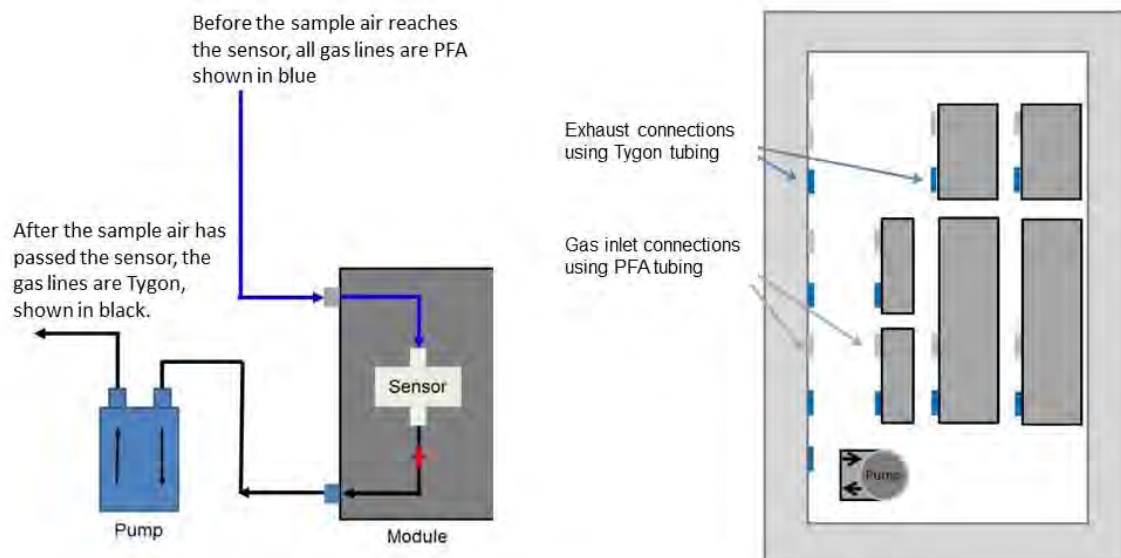

**Figure 1-7 A single pump is used for all gas modules. The vacuum port of the pump is connected to the outlet of each gas module**

The gas modules are connected in two rows inside the AQM 65 enclosure. There is one main gas inlet for sampling ambient air and one gas exhaust port both shown in Figure 1-8. Each gas module is connected to the pump via the **Tygon exhaust manifold**. The modules are connected in **parallel** as shown in Figure 1-8 on the left side. Each gas module is connected to the inlet via the **PFA sample manifold**, also in parallel as shown in Figure 1-8 on the right.



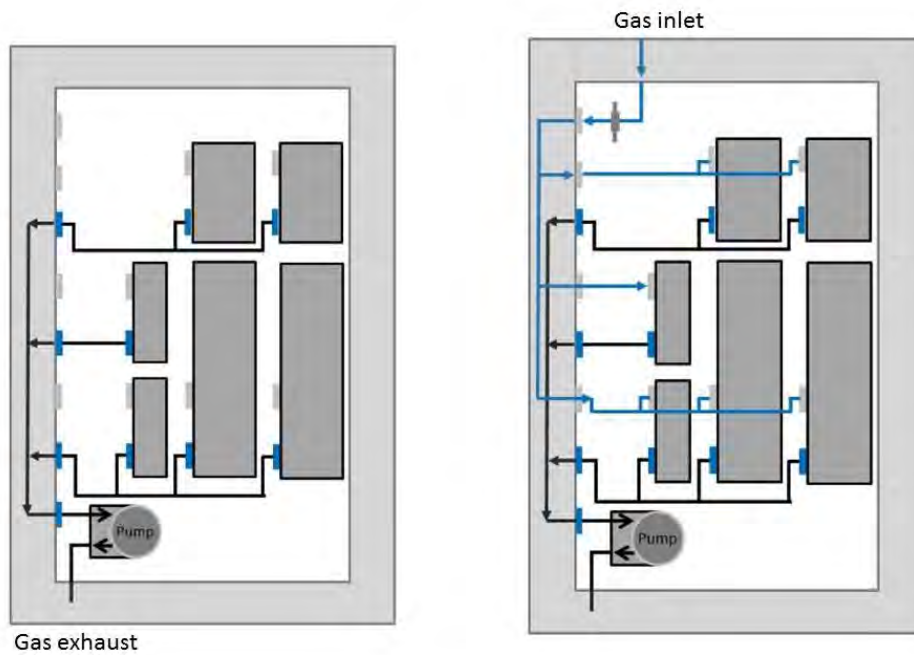

**Figure 1-8 Each module is connected to the exhaust and inlet manifolds in parallel.**

Part of the manifold is protected on the inside left wall of the enclosure, behind the insulation so it cannot be seen. The pump uses a flow bypass valve to regulate the pressure on the vacuum side of the pump, this by-pass valve is used to regulate the overall flow through all of the module simultaneously. This is discussed in more detail in Section 4.4.3.3.

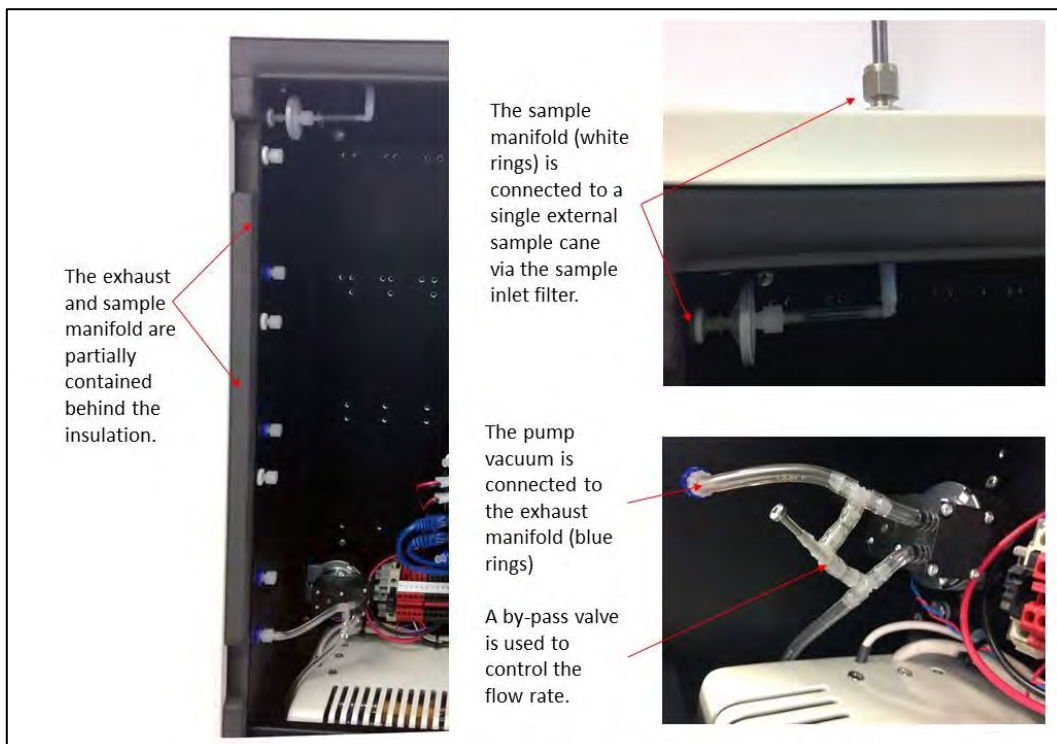

**Figure 1-9 The vacuum side of the pump is connected to the exhaust manifold (blue rings). The AQM 65 inlet is connected to the inlet manifold (white rings). The pump has a by-pass valve to control flow rate.**

## 1.2 Particulate matter (TSP, PM10, PM2.5, PM1.0) modules

The AQM 65 can measure particulate matter such as PM10 and PM2.5. There are **three** separate modules:

1. for measuring the particulate (**optical engine**), there are two types of optical engine:
  - the Particle Monitor uses a nephelometer (See Figure 1-10)
  - the Particle Profiler use an optical particle counter (OPC) (See Figure 1-16)
2. for handling the data transfer (**I/O module**)
3. for controlling the flow rate (**pump module**)

The Particle Monitor measures a single size fraction such as TSP or PM10 or PM2.5 or PM1.0. A Particle Profiler measures four size fractions simultaneously, TSP and PM10.0 and PM2.5 and PM1.0.

The Particle Monitor has an international performance certification (MCERTS), and is more accurate than the Particle Profiler.

The sample flow for the Particle Monitor and Particle Profiler is separate from the gas sample flow. There is a separate pump, a separate inlet and a separate exhaust.

### 1.2.1 Particle Monitor modules

The Particle Monitor uses a custom Met One near forward scattering nephelometer to measure particle concentration and a sharp cut inlet cyclone to select the particle size. This module is shown on the far right in Figure 1-10.

An AQM 65 can be configured with one Particle Monitor to measure a single particle size or an AQM 65 can be configured with two separate Particle Monitor systems so that two size fractions can be measured at the same time.

All of the modules used in the Particle Monitor system are held in the top row of the AQM 65. Figure 1-10 shows an AQM 65 with one Particle Monitor installed (three modules total) and Figure 1-11 shows an AQM 65 with two Particle Monitors installed (six modules total).



Figure 1-10 The Particle Monitor uses three modules: a) the optical engine on the far right, b) the pump module in the middle, c) the I/O module on the left



In the single Particle Monitor configuration, the three modules are held in the top **right** corner. If the AQM 65 contains two Particle Monitor then all six modules will be in the top row. The standard configuration is to have the PM10 on the right and the PM2.5 on the left.



**Figure 1-11 Two Particle Monitors can be installed in an AQM 65, each Particle Monitor will have three modules each**

The size selection is determined by the sharp cut cyclone on the Particle Monitor inlet on the outside of the AQM 65 shown in Figure 1-12.

An AQM 65 that has a single Particle Monitor can be configured to measure either of these four size fractions simply by changing the inlet cyclone and making a small change in the software. This is described in Section 4.5 of the online training website.

	Online reference	<a href="http://training.aeroqual.com">training.aeroqual.com</a> AQM 65 technical training Section 4.5
---	------------------	--



**Figure 1-12 Size selection in the Particle Monitor is determined by the sharp cut cyclone on the inlet**  
See section 4.4.7.4 for how to change the size designation in the software.

## 1.2.2 Nephelometer optical module: 80180 upgraded to 82850

In August / September 2018 Aeroqual upgraded the optical module in the particle monitor from the 80180 model nephelometer to the 82850.

- The 82850 optical module has a digital communication to the IO module, the 80180 communication is analogue.
- The size and form factor of the 82850 optical module is identical to the 80180
- The nephelometer optical module can be distinguished by the label, which shows the part number.



Figure 1-13 Left: 82850 optical module, Right 80180 optical module, the size and form factor are identical

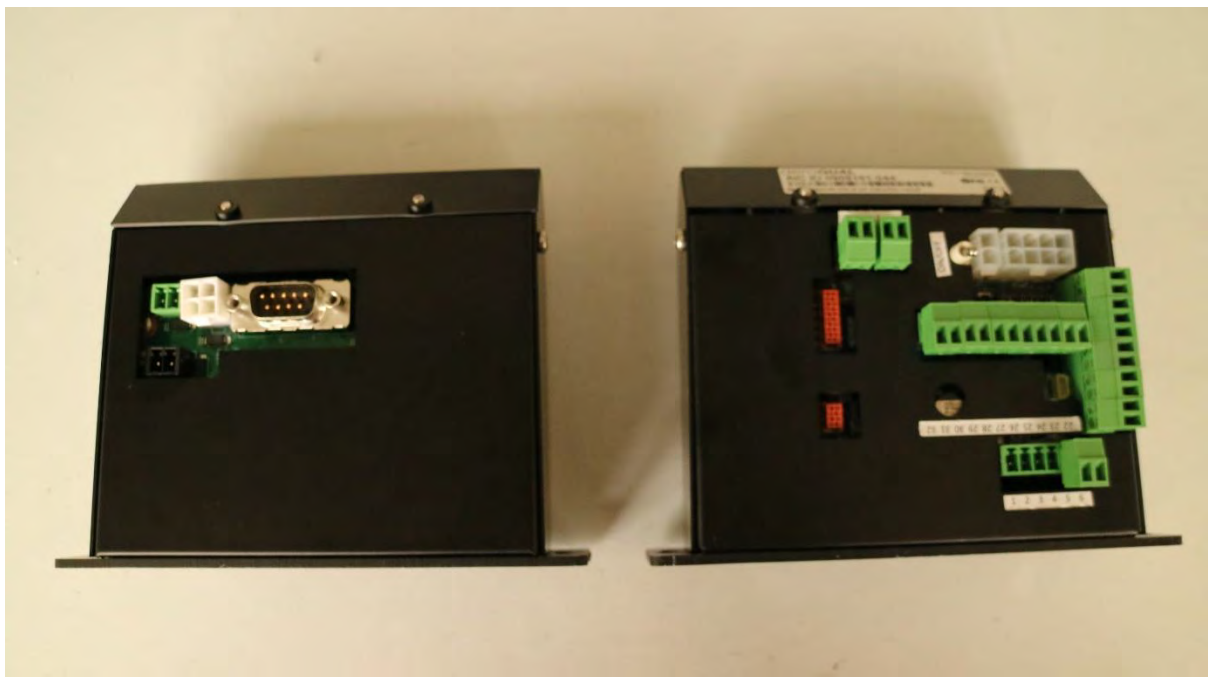

Figure 1-14 Left IO module for the 82850 optical module, note that the fibre span switch is no longer used, Right IO module for the 80180 optical module

The 82850 optical module requires a different IO module to the 80180 optical module, see Figure 1-14. If you need to replace your 80180 optical module then you will also need to replace the IO module.

- The flow rate of the 82850 optical module is 2.0LPM (same as the 80180 optical module).
- There are some changes to the software for operating the 82850 module, see 4.4.7.3 and 4.4.7.4.
- The 82850 optical module does not require a fibre span, so this has been removed.
- The 82850 includes a time counter in the diagnostics which can be used to determine when the optical engine is due for calibration. When the counter approaches 17520 hours (2 years) a factory calibration is due. See 4.4.7.3 for a description of the diagnostic channels.



**Figure 1-15** See the video discussing the changes to the optical module  
<https://www.youtube.com/watch?v=2ZoK9IQftGU&t=7s>



### 1.2.3 Particle Profiler modules (and upgrade to profiler pump module)

The AQM 65 uses a Met One optical particle counter to measure four particle size fractions simultaneously. There is no sharp cut cyclone used in the Particle Profiler; both the concentration and size are measured inside the optical particle counter.

The three modules for the Particle Profiler are installed in the top right side of the AQM 65 enclosure. An AQM 65 will only ever have one Particle Profiler installed.

The Particle Profiler has the sample and purge filters mounted on the outside of the optical module, (in the Particle Monitor they are held inside the optical module).



**Figure 1-16 The Particle Profiler uses three modules: a) the optical module on the far right, b) the pump module in the middle, c) the electronics module on the left. The image above is the arrangement prior to July / August 2018.**

In July / August 2018 a change was made to the pump module. The filters are now installed inside the pump module as shown in Figure 1.17 below. This was done to create more space in the enclosure. The new pump module is backwards compatible with existing profiler systems. There is a small change to the way the leak check is performed, see Section 4.4.6.1.



Figure 1-17 An update to the pump module with the filters installed inside the pump module

### 1.2.4 Comparison between the Particle Monitor and the Particle Profiler

- The Particle Profiler measures particulate concentrations using particle counting, it measures multiple size fractions at the same time.
- The Particle Profiler can measure TSP and PM10 and PM2.5 and PM1.0 without requiring a sharp cut cyclone.
- The Particle Monitor measures particulate concentrations by nephelometry, it measures TSP or PM10 or PM2.5 or PM1.0 using a sharp cut cyclone.
- There is a difference in the accuracy of the measurement for the Particle Profiler compared to the Particle Monitor, see Table 1-2.
- The Particle Profiler is not certifiable under the MCERTS framework.

	Particle Monitor	Particle Profiler
Mass measurement	TSP <b>or</b> PM10 <b>or</b> PM2.5 <b>or</b> PM1.0 Can be configured with two Particle Monitors	TSP and PM10 and PM2.5 and PM1.0
Accuracy	$<\pm(2 \mu\text{g}/\text{m}^3 + 5\% \text{ of reading})$	$<\pm(5 \mu\text{g}/\text{m}^3 + 15\% \text{ of reading})$
International certification	Yes, MCERTS for PM10	No certification
Factory calibration period	Every two years (24 months)	Every year (12 months)
Inlet flow rate	2.0 LPM	1.0 LPM

Table 1-2 Summary of the difference between the Particle Monitor and the Particle Profiler.

### 1.3 Optional external sensors and auxiliary modules

The AQM 65 can integrate a number of external sensors such as weather sensors, solar radiation and noise sensors. These sensors are mounted outside the AQM 65 enclosure. An auxiliary module (AUX) module is used to provide power to the external sensor and to process data from the sensor. Some examples of external sensors are shown in Figure 1-18. The AUX module is shown in Figure 1-19. The external sensors which Aeroqual supports include (shown left to right in Figure 1-18).



- MSO weather station from Met One
- MK427 noise meter from Cirrus
- WXT536 weather station from Vaisala
- Windsonic from Gill Instruments
- LI-200 Pyranometer from Li-Cor

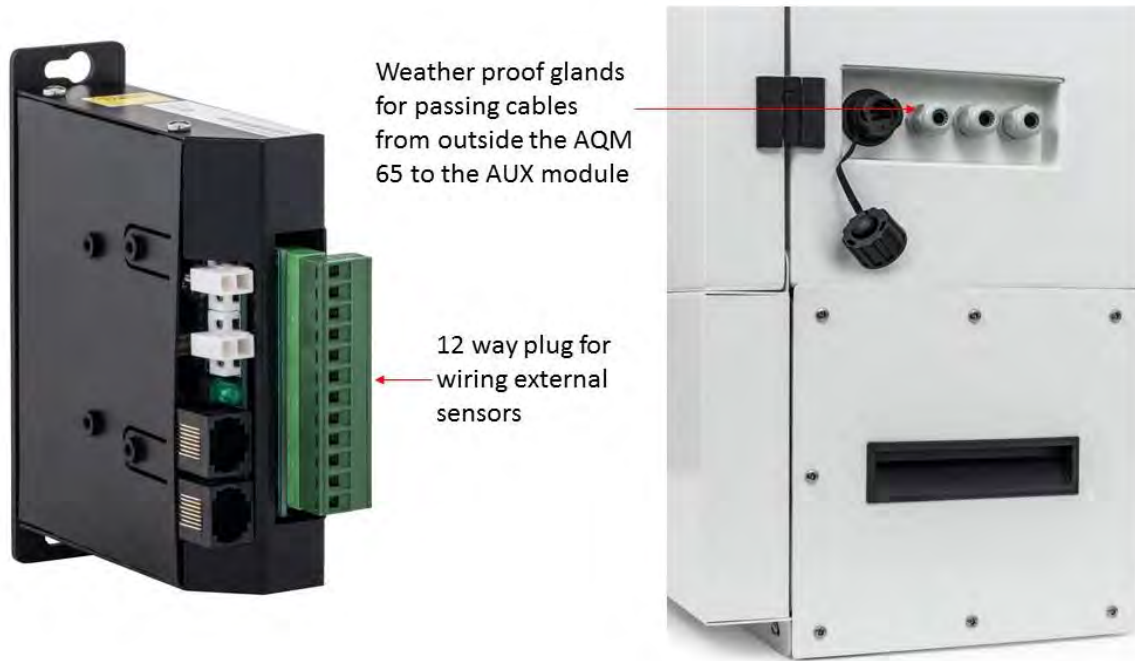

**Figure 1-18 The AQM 65 can integrate several external sensors**

The AUX module uses a 12 way green connector plug to connect to the external sensor. The cable from the external sensor is threaded through a water proof gland on the right outside wall of the AQM 65 and then connected to the green plug on the front of the AUX module.

Details on how to mount each external sensor and how each sensor is wired to the AUX module are given in the online training:

	Online reference	<a href="http://training.aeroqual.com">training.aeroqual.com</a> AQM 65 technical training Section 2.5
	Online video	AQM, Dust Monitor Setup and Commissioning Playlist



**Figure 1-19** The external sensors are connected to the green plug on the Aux module. The cable passes through water proof glands on the right wall of the AQM 65

### 1.3.1 Temperature and Humidity Sensor

Every AQM 65 comes preconfigured with a temperature and humidity sensor located underneath the AQM 65 enclosure. The temperature sensor is cable of measuring down to  $-40\text{ }^{\circ}\text{C}$  and above  $50\text{ }^{\circ}\text{C}$  with an accuracy of  $\pm 0.3\text{ }^{\circ}\text{C}$  and humidity range is 0 to 100 %.with an accuracy of  $\pm 2\%$

## 1.4 Thermal management system and system manager module

The AQM 65 has a thermal management system (TMS) to maintain a stable internal temperature irrespective of ambient temperature changes.

The internal set-point temperature is typically  $30.0 \pm 0.5\text{ }^{\circ}\text{C}$ , but this can be changed to better suit the external temperature conditions. Section 4.4.12 discusses this in detail.

The internal temperature is maintained using a fridge compressor for cooling and resistive heaters for warming. The AQM 65 has thick insulation foam to minimise heat transfers through the wall and the outer shell has a high performance reflective coating to minimise solar incidence.

The compressor is located on the bottom of the AQM 65 behind a protective shield and can be removed if required. Temperature controlled air is passed into the compressor heat exchanger through vents in the bottom of the enclosure. Air is then passed behind the back plate and then out a vent at the top of the inside of the enclosure, Figure 1-20.



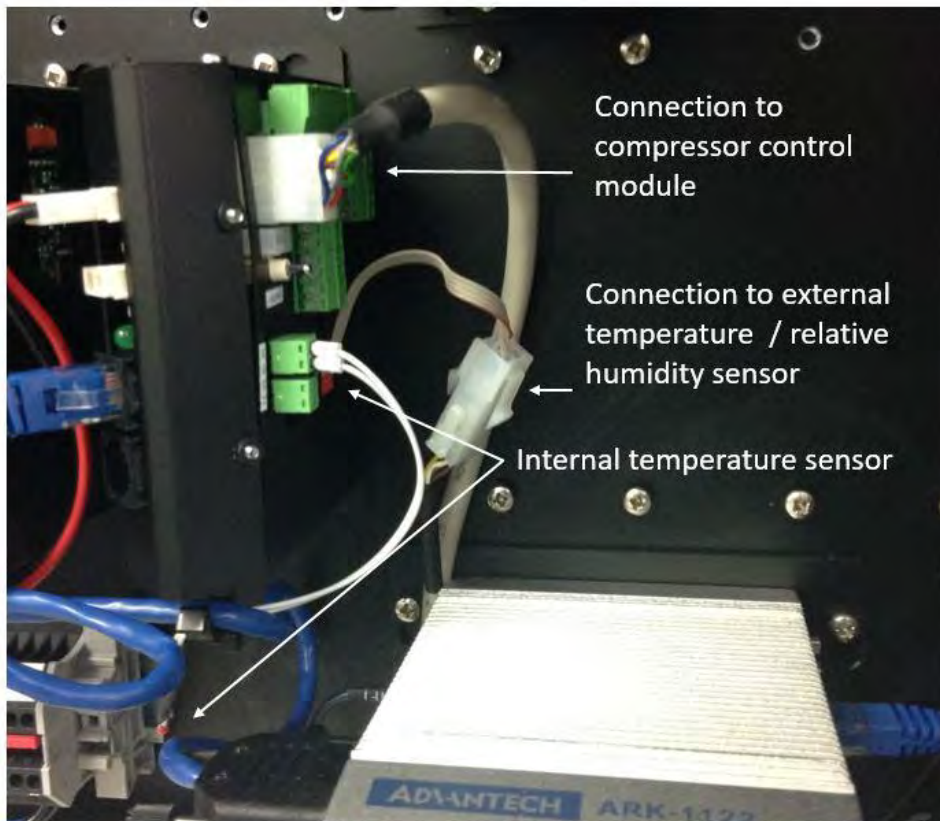

**Figure 1-20** Air conditioned air is constantly circulated in the AQM 65 enclosure. Air comes in to the enclosure at the top and exits through vents at the bottom

The system manager module shown in Figure 1-21 is used to measure the internal temperature and control the compressor and heaters to maintain a constant internal temperature. The system manager module also connects to the external temperature/RH sensor. The system manager module is placed above and to the left of the embedded PC.

**NOTE:** The switch on the side of the system manager module has no function, it is deactivated.





**Figure 1-21** The system manager module controls the internal temperature and also measures the external temperature and relative humidity

## 1.5 Interfacing with the AQM 65 using Connect and Cloud

There is no software to download or install. Engineers who need to perform service or data users who need to view or download data can do so using a browser on their PC, tablet or smart phone.

### 1.5.1 Aeroqual Connect

Aeroqual connect is the instrument's operating system. The AQM 65 is controlled with an embedded PC, (ePC) which is running a webserver. The user connects to the AQM 65 using a web browser such as Firefox, Chrome or Safari. The connection can be over WIFI, Ethernet cable or cellular modem.

Aeroqual connect contains all of the tools necessary to view and download the data and maintain and calibrate the AQM 65.



**Figure 1-22** Aeroqual Connect is the operating system for the AQM 65. Aeroqual Connect is accessed using a web browser.

## 1.5.2 Aeroqual Cloud

Aeroqual Cloud gives you and other trusted users access to all of your instruments via secure third party servers. Use Cloud to:

- Communicate with your instrument from anywhere in the world at any time
- Use advanced charting features such as wind roses and pollution roses
- Receive fast and comprehensive technical support from your distributor or Aeroqual technical support team.
- Automatically export data to multiple users via email or to an FTP server.
- Securely back up data in case of local data access issues.
- Maintain service records in the Cloud Journal for auditing and engineer certification.

There are three versions of Aeroqual Cloud available: see [www.aeroqual.com/product/air-monitoring-software](http://www.aeroqual.com/product/air-monitoring-software) for details on what is included. Aeroqual Cloud Support is a free Cloud version and is used to make technical support fast and efficient for the end user. Aeroqual Cloud basic and Cloud Plus offer extra features and are paid for on a yearly basis.

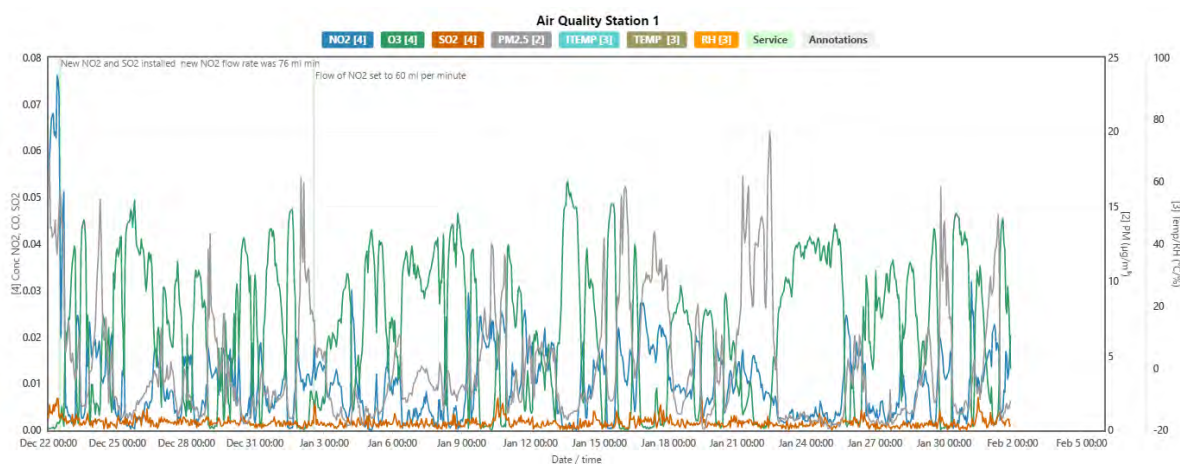

Figure 1-23 Aeroqual Cloud has many useful features such as plotting multiple channels on a single graph

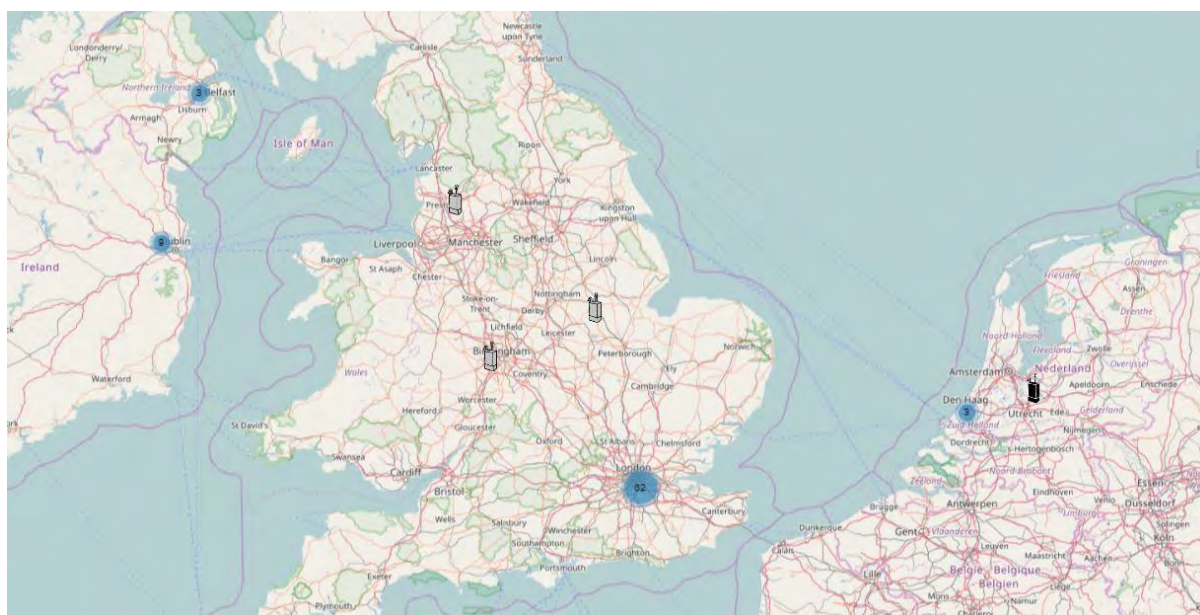
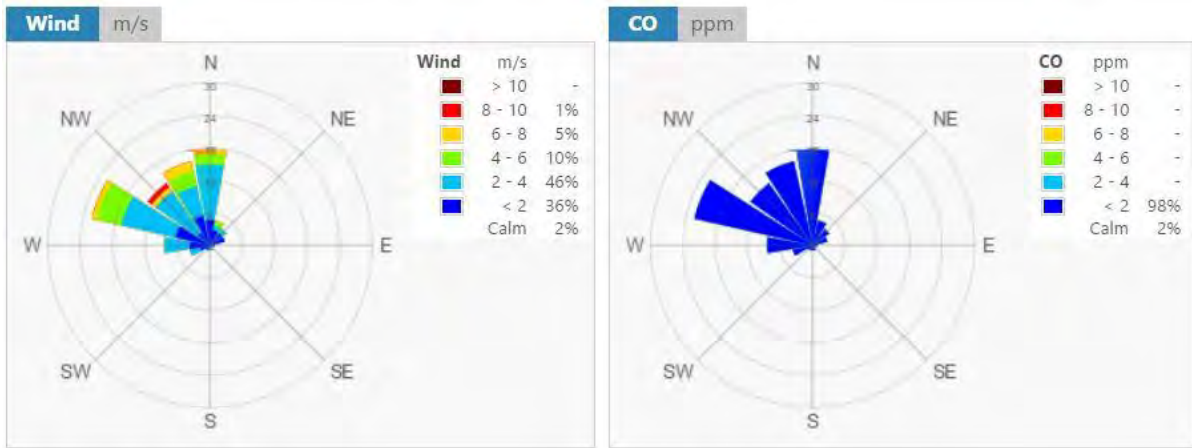

Figure 1-24 Select multiple instruments by region, and plot data from multiple different instruments on the same graph.





**Figure 1-25** Generate advanced graphical presentations such as wind roses and pollution roses.



**Figure 1-26** Receive SMS text alerts directly to your smart phone or by email.

**Advanced support from your distributor and the Aeroqual technical support team**

Aeroqual Cloud allows the technical support team to provide fast and comprehensive technical support directly to the end user. Instrument diagnostics and operational parameters are immediately available to Aeroqual engineers through Aeroqual Cloud which

## 1.6 Quick start guide

Detailed instructions for AQM 65 set up and start up are given in Chapter 2. Below is a quick start up guide.

- Instructions on how to wire mains power are given in Section 2.2.1
- The instrument will fully start up as soon as mains power is connected. There is an on/off button (fuse holder) next to the 12 Volt DC rail at the bottom of the AQM 65.
- The fuse can be pulled out initially while mains power is being connected to prevent frequent power cycling during the initial connection to mains power.
- With the fuse pulled out you will still hear the internal blower and will be to feel air flow coming from the top, See Figure 1-20.

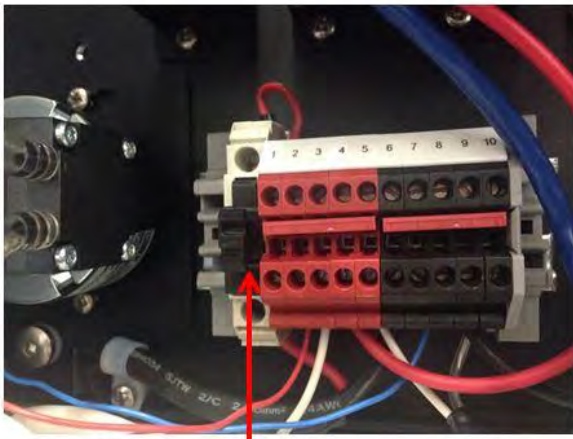

12 V DC fuse pushed in, the “on” position

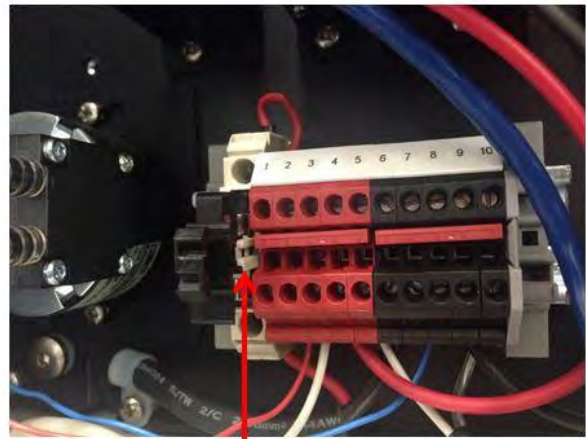

12 V DC fuse pulled out in the “off” position

**Figure 1-27** The fuse holder next to the 12 V rail can be pulled out to turn off the AQM 65 while mains power is attached.

- Remove the protective film before pushing the fuse back in (turning the instrument on).
- After the AQM 65 ePC has booted up, the AQM 65 will appear as a WIFI network in your list of WIFI networks on your device. Log on to the WIFI network with password “**Aeroqual**”.



**Figure 1-28** Remove the protective film from the PM before starting. Once you have started check your WIFI network list

- Then open a browser window and type 10.10.0.1 in the address bar. Login to Connect using login name: **administrator** password **aqmadmin**

**NOTE:** See Section 3.1: Connecting to your AQM 65 for the first time for more detail

## 2 Set-up

The purpose of this section is to enable the user to correctly assemble, check and configure the AQM 65 in a workshop, laboratory or office before field installation.

The AQM 65 must be unpacked and inspected upon arrival in the destination country. This must occur before on shipment. If there is any damage during international transit from Aeroqual immediate inspection is needed to verify this.

At the same time Aeroqual recommends these steps be performed in an office or laboratory environment to make sure the flow system, electrical system and communication system are working as expected.

Some of the steps described here will be repeated in the field as part of the installation and commissioning process.

A guide to field installation and commissioning is given in Appendix 5.

### Key points to consider for assembly and first power up:

- The AQM 65 runs on single phase mains AC power (90 – 305 VAC, 47 – 63 Hz). A detailed description of the DC power requirements (to assist with solar installations or UPS specifications) is given in the Appendix 3,
- You need to supply a mains power cable and local plug, Aeroqual recommends a residual current device (RCD) be used to protect against power spikes.
- You will only need a Phillips head screwdriver for assembly in the laboratory or office.
- There is no software to download and install, and no cables are require for communication. Communication to the AQM 65 is through your web browser on your laptop, tablet or smart phone using WIFI.
- If you have purchased a MOXA modem, this needs a local SIM (dynamic IP) like the one you would have in your smart phone, but you must know the APN of your chosen telecommunications provider, you can look this up: [www.apnchanger.org](http://www.apnchanger.org)

## 2.1 Unpacking

The AQM 65 is packaged in a rigid galvanised stainless steel shipping container which is lined with protective foam.

The dimensions of the shipping container are 103 x 75 x 40 cm. The total weight of the AQM 65 in its shipping container is about 65 kg (150 lbs).

**See Appendix 2 for the exact dimensions and weight of the AQM 65**



**Figure 2-1 The total weight of the AQM 65 in its shipping container is about 65 kg (150 lbs).**

The shipping container is designed to be reused, so that the AQM can be re-packaged and transported safely. See section 2.4 on repackaging and transport.

Additional components such as weather or noise sensors will be packaged in additional boxes.

- Examine the Shockwatch label on the side of the shipping box. If the indicator is red do not refuse the shipment. Make a notification on delivery receipt and inspect for damage. If damage is discovered, leave item in original packaging and request immediate inspection from carrier within 15 days of delivery date (3 days international). Contact Aeroqual or your representative immediately.
- Verify the serial number label on the documentation matches the serial label on the AQM 65
- Verify all components have been shipped as per the packing slip. Contact Aeroqual or your representative if you suspect any parts are missing.

## 2.2 Initial assembly and powering the AQM 65 for the first time



The AQM 65 requires only basic assembly out of the box.

- Wire a mains AC power cable
- Attach Particle Monitor / Particle Profiler inlet
- Attach gas inlet
- Attach third party sensors
- Configure MOXA modem



## 2.2.1 Wire AC mains power and initial start-up.

Remove the front cover and also remove the mains AC power box cover. Then feed the mains power cable through the gland on the bottom floor of the AQM 65 as shown in Figure 2-2.

	Online reference	<a href="http://training.aeroqual.com">training.aeroqual.com</a> AQM 65 technical training Section 2.3
	Online video	You Tube Channel: Aeroqual Set-up and Commissioning playlist

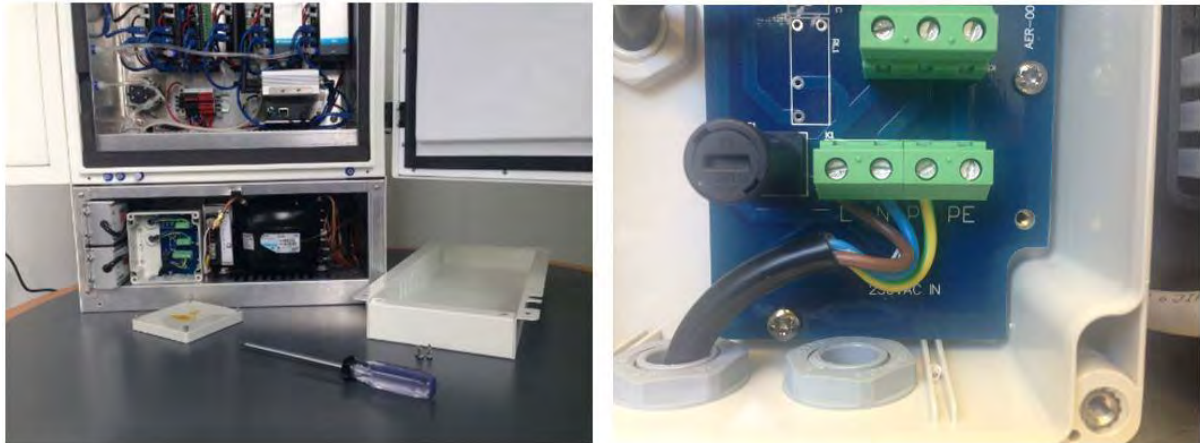

Figure 2-2 Remove the front cover to wire mains power to the AQM 65

Pull the 12 VDC fuse out from the fuse holder “off position” before testing the mains connection.

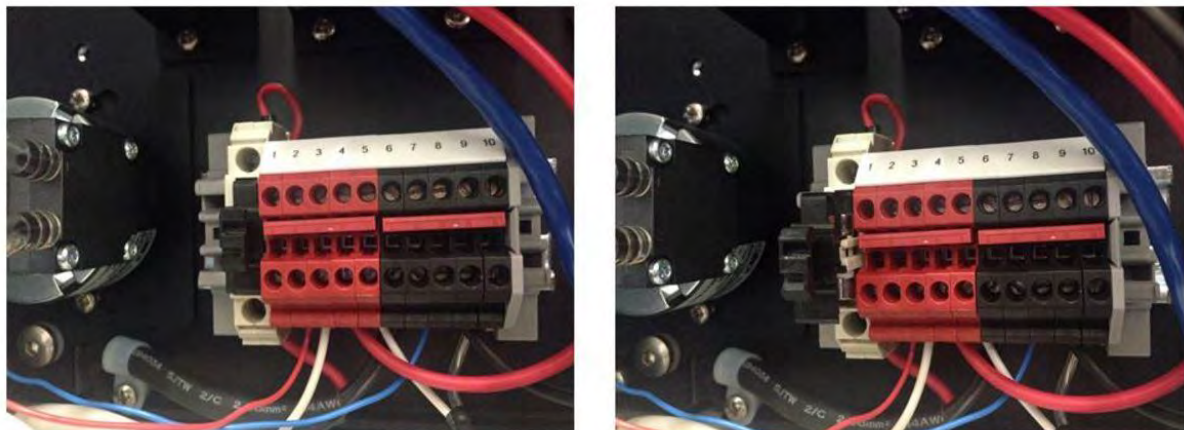

Figure 2-3 The 12V DC fuse can be pulled out to turn off the AQM or pushed in to power the AQM 65

When you apply mains AC power (and with the 12 DC fuse in the “off” position) you should hear the internal fan (blower) start up and begin circulating air inside the box. Air will come out from the top vent as shown in the image on the right in Figure 2-4

Nothing else should be on.

### IMPORTANT!

- ⚠ If you wish to test 12 DC power to the rest of the AQM 65 now, then you should remove the power connection to the PM electronics module, otherwise you could damage the optical engine. Pull the power connection out from the PM pump module as shown in Figure 2-3 on the left.

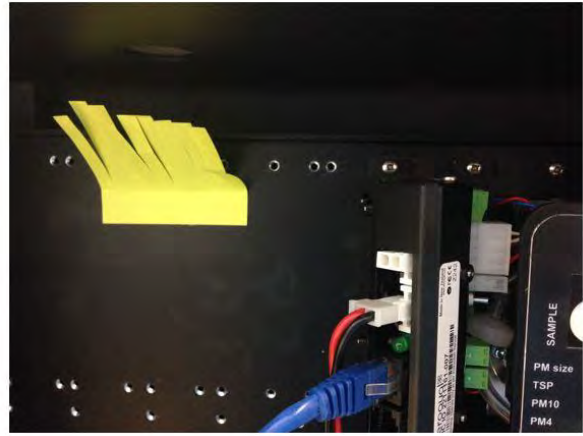



**Figure 2-4** With mains power on, and with the 12 V DC fuse pulled out, there should be air flow coming from the top of the AQM as shown on the right. Disconnect the power (red/back) cable from the PM pump module while testing the power, as shown on the left

Once you have removed the PM power then push in the 12 DC fuse to the “on” position as shown in Figure 2-3 on the left.

The green power LED lights should light up on the modules when power is applied, this confirms the power is being correctly delivered to the modules.

## 2.2.2 Attach PM inlet

	Online reference	<a href="http://training.aeroqual.com">training.aeroqual.com</a> AQM 65 technical training Section 2.4
	Online video	You Tube Channel: Aeroqual Set-up and Commissioning playlist

- Turn off power to the AQM 65 during this process by pulling out the 12 DC fuse.
- The Particle Monitor and Particle Profiler ship from the factory with a thin film of tape which protects the inlet, this must first be removed as shown in Figure 2-5.

**NOTE:** If your AQM 65 has two Particle Monitors as shown in Figure 1-11, the PM10.0 inlet is fitted on the right side and the PM2.5 is fitted on the left side.





Figure 2-5 Remove the protective tape from the PM inlet

- Attach an O-ring to the aluminium retaining ring and apply a small amount of lubricant.



Figure 2-6 Add the O-ring and a small amount of lubricant.

- The inlet is wrapped in a thin film heater which has a white plug on the end.
- Carefully thread the white plug through the PM inlet port on the roof of the AQM 65.

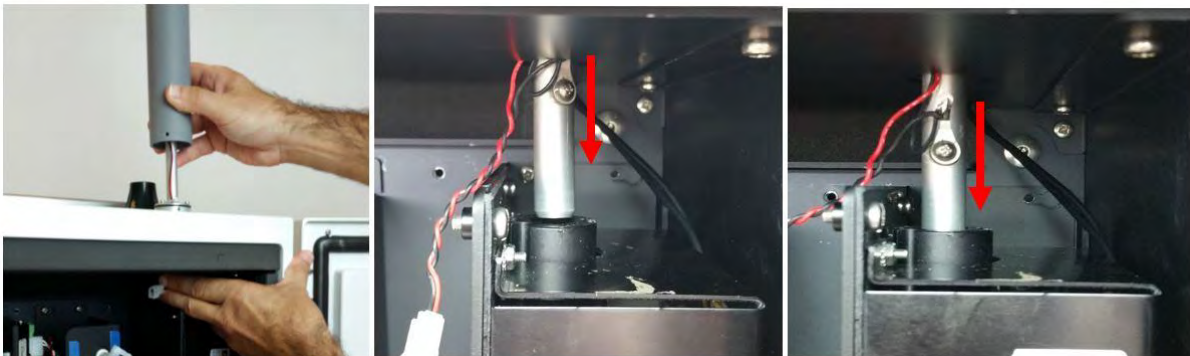

**Figure 2-7 Gently feed in the power cable. The aluminium tube must push all the way in to the PM module.**

- It is very important to make sure that the aluminium inlet tube is pushed all the way into the optical engine block.
- If the aluminium tube does not fully push down in to the optical engine block, then create more length in the aluminium tube by removing the grey retaining nut and then sliding up the rubber grommet on the top of the inlet. Replace the nut after you have done this.



**Figure 2-8 Create more length to the inlet by sliding the black rubber grommet up the tube.**

- You need to make sure you have correctly and securely inserted the aluminium tube fully in to the optical engine block.
- Push the fuse holder in to the “on” position. And connect the white power plug to the module to begin flowing air through the inlet.
- Then perform a leak check and flow check. See Section 4.4.5 and Section 4.4.6



Place gauge on inlet above cyclone



Remove power cable from electronics module

**Figure 2-9 Apply power to the PM module, then fit the vacuum gauge to the inlet to test for leaks.**

- When you are satisfied the inlet is fully pushed in to the engine block, then connect the heater plug on the inlet to the plug coming from the module.

Insert the three 6/32 UNC retaining screws to secure the inlet to the aluminium retaining ring

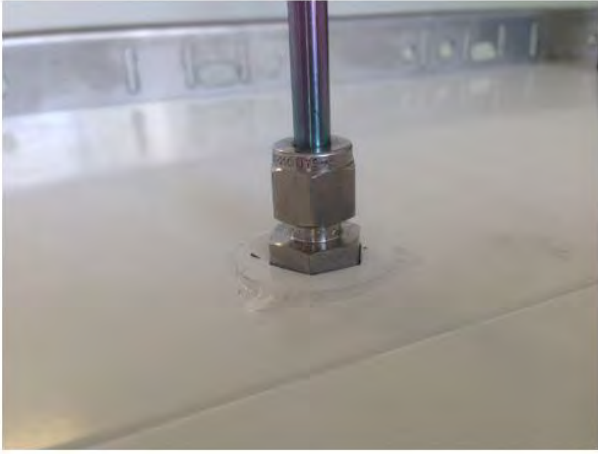

**Figure 2-10 During field installation, secure the PM inlet using the retaining screws and plug in the heater**

### 2.2.3 Attach gas inlet

- The gas inlet is held by a ¼ inch Swagelok compression fitting.
- Attach the inlet and perform a flow check to make sure the inlet is fitted correctly and the sample pump is working properly.
- When the AQM 65 is sampling ambient air in the field, a Kynar inlet fitting with mesh is attached to the Swagelok nut at the end of the sample cane.



**NOTE:** Detailed instructions on gas flow measurement are given in Section 4.4.3.1



**Figure 2-11 Connect inlet to AQM 65 and measure the flow rate to determine if connection is secure**



## 2.2.4 Wire external third party sensors

	Online reference	<a href="https://training.aeroqual.com">training.aeroqual.com</a> AQM 65 technical training Section 2.5
	Online video	You Tube Channel: Aeroqual Set-up and Commissioning playlist

- External sensors such as weather stations and noise meters need to be wired to the green connector plug on the front of the auxiliary module.
- Each third party sensor requires a different wiring configuration.
- The correct wiring configuration for each sensor is given in the online training

**NOTE:** To check the operation of the third party sensor in your office or laboratory prior to site installation it is not required to feed the cable through the gland.



**Figure 2-12** To connect third party sensors such as weather sensors, feed the cable through the gland and wire to the green plug.

- If you are happy with the wiring then apply power, and log on to the Aeroqual Connect software. After some minutes you should see the parameters associated with the third party sensor being shown in the software.

## 2.3 Set up MOXA G3111 HSPA modem for remote communication

	Online reference	<a href="http://training.aeroqual.com">training.aeroqual.com</a> AQM 65 technical training Section 2.6
---	------------------	--

- Aeroqual supplies a cellular modem (MOXA G3111 HSPA) for remote communication. This is Aeroqual part number R38. This must be correctly configured to work on the local telecommunications network in your country.
- The modem requires a standard SIM card (dynamic IP) which you can buy from a cell phone store. The SIM card fits in a slot underneath the modem as shown in Figure 2-13
- You must know the APN of your cellular provider, you can find out the APN by going to [www.APNChanger.org](http://www.APNChanger.org) and looking up your country and cellular provider.
- Directly connect the MOXA modem to your PC using an Ethernet cable.
- Then enter the APN in to the correct field through the MOXA configuration interface shown in Figure 2-13



Figure 2-13 A SIM card must be inserted in to the modem and the Modem must be configured

**NOTE:** It can take 12 to 24 hours for the AQM 65 to fully warm up and provide stable accurate readings. During this time the readings can be outside of what is expected

## 2.4 Re-packing and transport

The packing crate and protective foam provided by Aeroqual should be retained for future re-packing and transport of the AQM 65.

The PM inlet and gas inlet must be removed before transporting the AQM 65.

The packing crate has supporting bolts and a re-enforcing cross brace which should be used to ensure stable packing and to prevent movement during transport and to protect against impact.

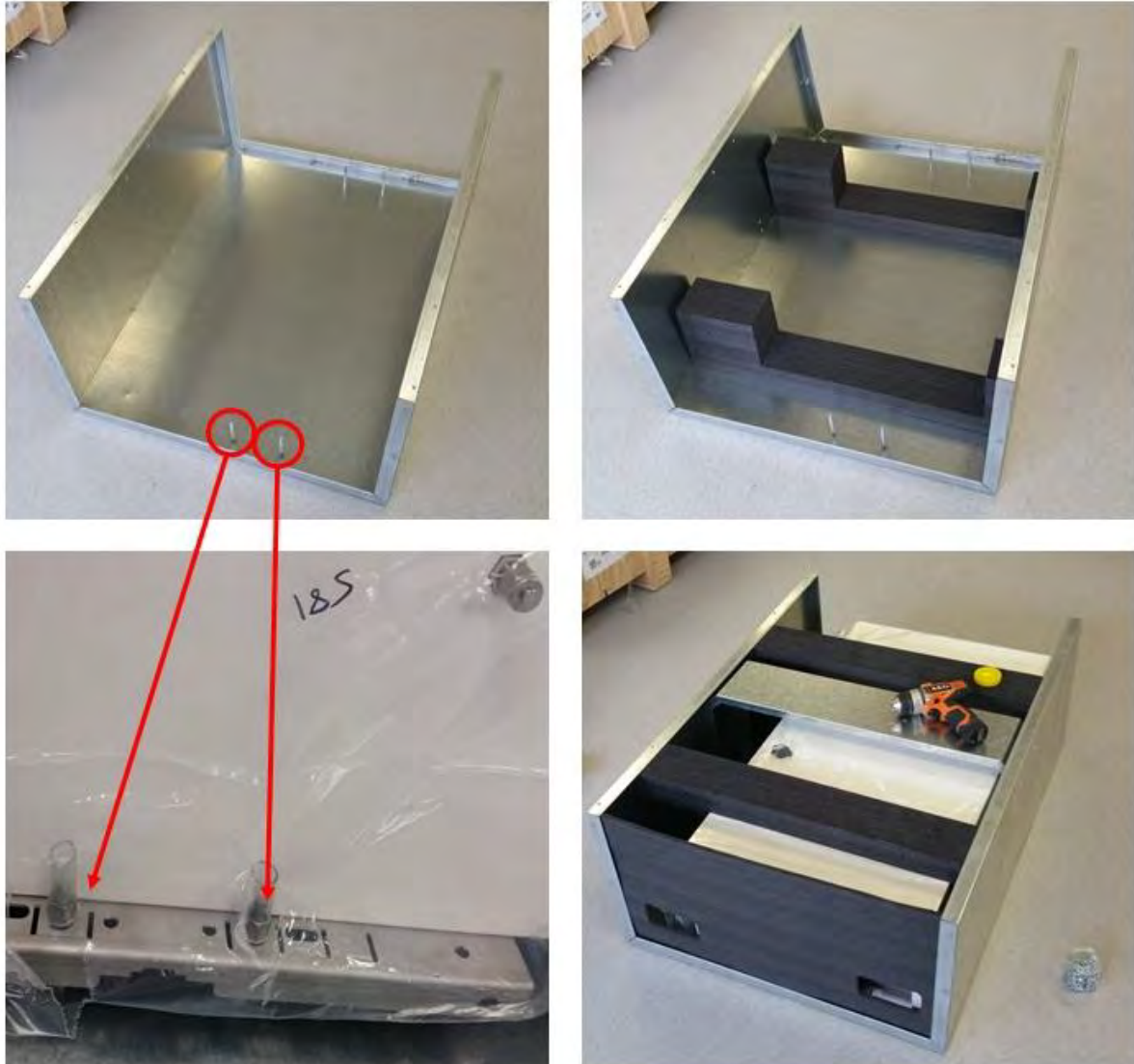
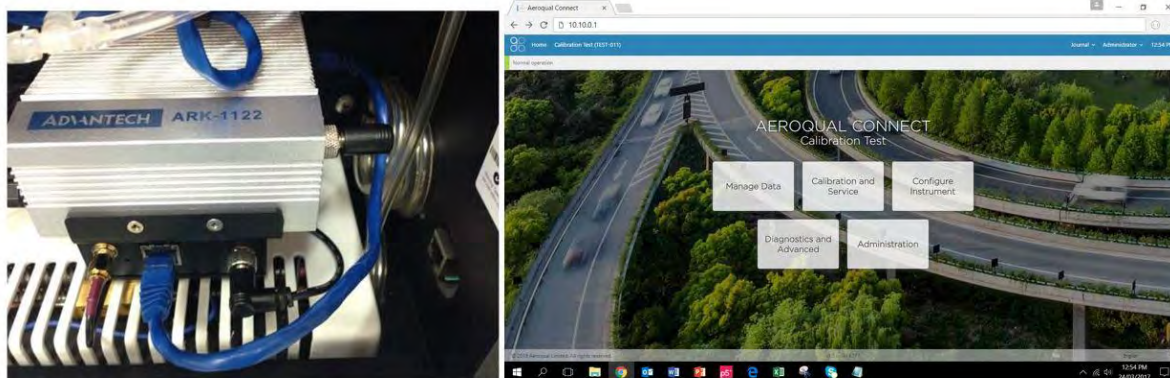

**Figure 2-14** The packing crate uses retaining bolts which go through the AQM 65 mounting brackets. There is an additional supporting brace shown in the top right image which should be used.

Figure 2-1 Shows the AQM 65 fully packed, the packing crate has handles which makes carrying the AQM 65 easy.

### 3 Connect Software

The AQM 65 uses an industrial embedded PC (ePC) for data logging and to run the instrument operating system, Aeroqual Connect. The ePC sits at the bottom right of the AQM 65. A cellular modem can be fitted underneath the ePC to facilitate remote connection and remote technical support.



**Figure 3-1** The AQM 65 is controlled by an ePC. A modem can be included under the ePC. On the right is the Aeroqual Connect user interface, Aeroqual Connect is installed on the ePC.

There is no desktop software required to download and install.

The AQM 65 ePC operates as a webserver, so the user connects to the AQM 65 through a web browser such as Google Chrome, Firefox, Edge or Safari, using their laptop, tablet or smart phone, either over WIFI or wired LAN or using a cellular modem.

Aeroqual Connect is running on the AQM 65 ePC. You can think of Connect as a website which is hosted locally on the AQM 65 therefore you will use your internet browser to connect to the AQM 65.

All of the instrument control and data analysis and downloading is achieved using apps within the web browser.

#### **This chapter discusses:**

- The different ways to establish a connection to the AQM 65
- The apps for instrument control and calibration
- The apps for data visualisation and data access
- How to control user access permissions and security

#### **Aeroqual Cloud**

In addition to Aeroqual Connect software that is running locally on the AQM 65 Aeroqual also offers a cloud based software service called Aeroqual Cloud.

Aeroqual Cloud allows the data from many AQM 65s to be visualised on one screen. Users can receive email or text alerts from Aeroqual Cloud. The AQM 65 must be connected to Aeroqual Cloud in order to receive software updates and bug fixes.

Aeroqual technical support requires that the instrument be connected to Aeroqual Cloud in order to provide fast and effective customer support.

If the AQM 65 is not connected to Aeroqual Cloud, technical support from Aeroqual will be limited and may be charged for.



### 3.1 Connecting to the AQM 65 for the first time

The AQM 65 ships from the Aeroqual factory as a WIFI access point. This means that when the AQM 65 is powered on, the AQM 65 will appear as an available WIFI network.

- The name of the WIFI network (SSID) will be the serial number of the AQM 65.
- The WIFI password is “Aeroqual”
- You must connect successfully to this WIFI network to achieve connection to the AQM 65.

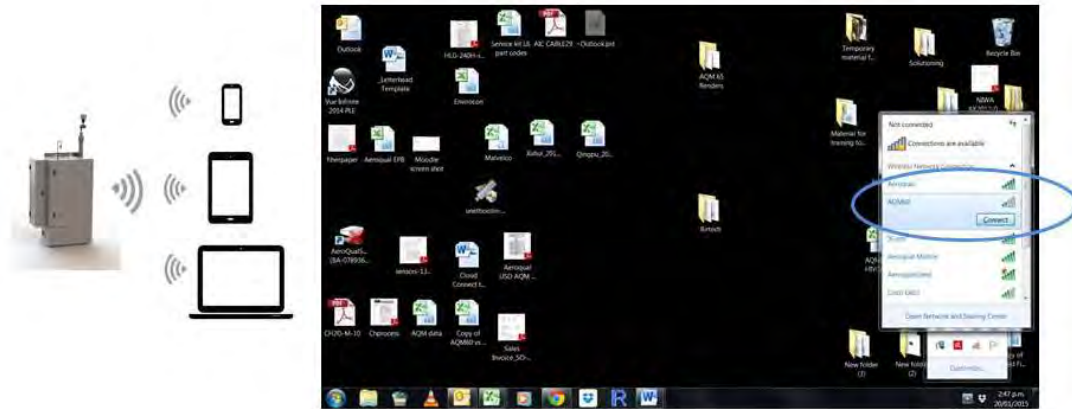

Figure 3-2 In WIFI access point mode the AQM 65 appears as a WIFI network in the list of WIFI networks on your PC.

The next step is to open a blank browser window and enter 10.10.0.1 in to the address bar.

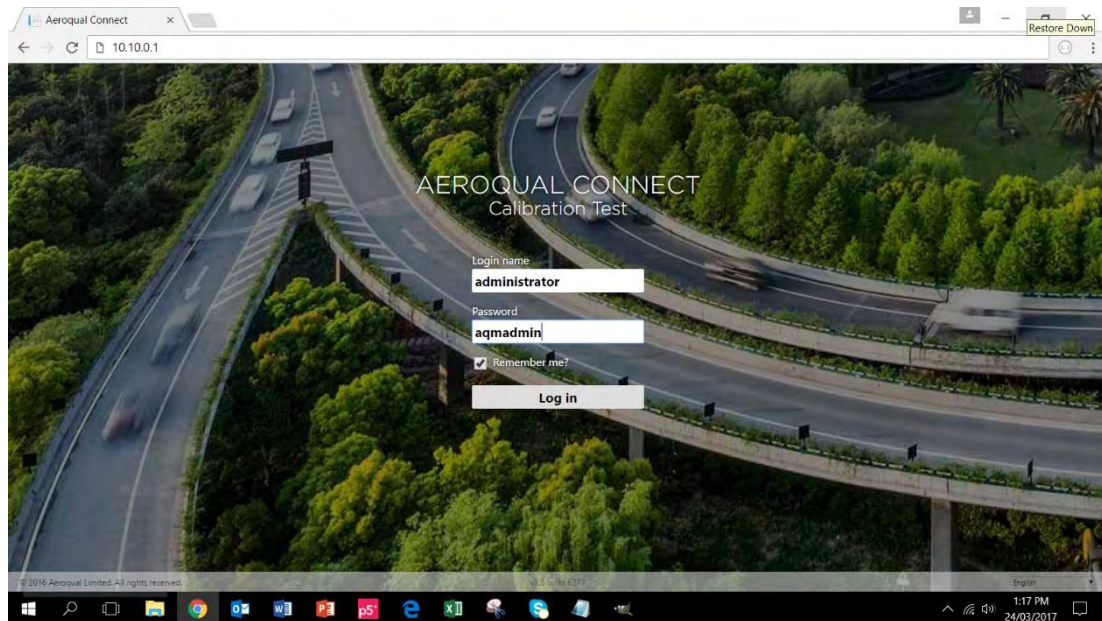
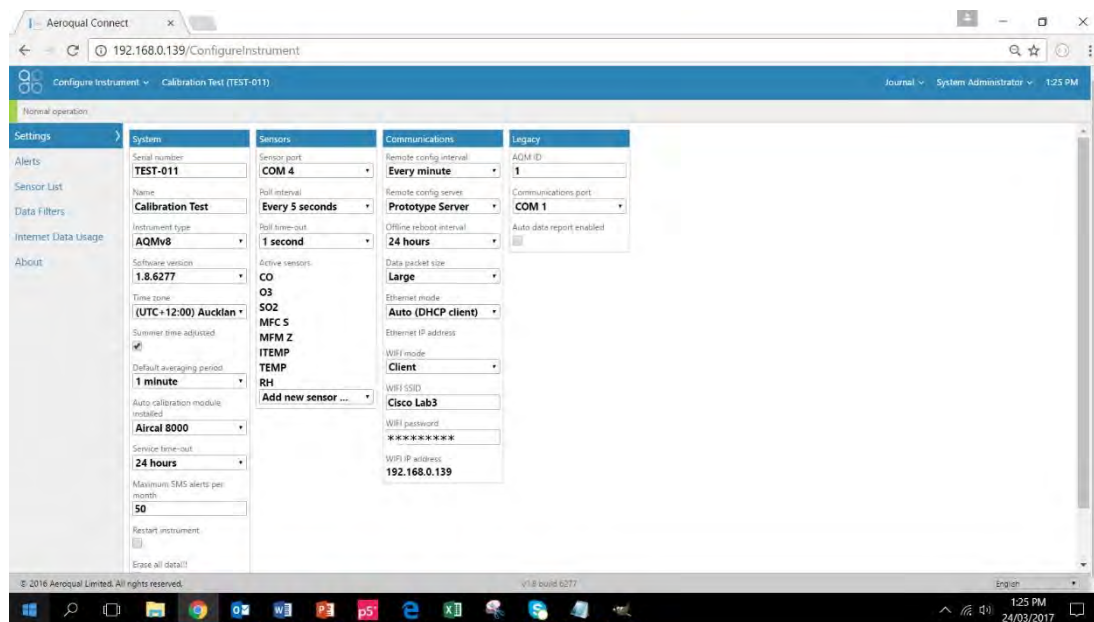

Figure 3-3 The AQM 65 default access login, this should be removed after another admin account has been created see section 3.5.1.

The default login name is “administrator” The default password is “aqmadmin”

## 3.2 Options for connecting to the AQM 65

There are several options to establish a communication connection to the AQM 65. These require the communication settings to be changed in the Configure Instrument App shown in Figure 3-4. The communications settings are entered in to the third column. Details of each of these communication methods and how to set them up in the Configure App are given in the online training. Common communication configuration settings are shown in Figure 3-7.



**Figure 3-4** Column three in the Configure instrument app control the communication and connection settings

There are two independent connection types; WIFI and wired Ethernet.

1. The ePC has built in WIFI which can be configured either:
  - as an access point
  - it can be used to connect to an existing LAN over WIFI
2. The ePC has a separate wired Ethernet connection, this can used in a number of ways:
  - To directly connect to a PC
  - To connect to a wired LAN via a router
  - To connect to an IP modem to provide cellular communication.

The WIFI connection and Ethernet connection are independent from each other so that both can be used at the same time.

The recommended configuration for connection is to set the WIFI mode to access point and the wired Ethernet to Client mode to use with the MOXA modem.

	WIFI	Wired Ethernet
<p><b>Direct Connection</b></p> <p>These are commonly used by an engineer who is on site with the AQM 65 to perform maintenance or calibration.</p>	<p>Used by engineers at location performing maintenance (recommended)</p>	<p>Used by engineers at location performing maintenance</p>
<p><b>Remote connection</b></p> <p>These are used by data analysts who need to download data, but don't need to visit the installation site.</p>	<p>The AQM 65 WIFI is connected to an existing WIFI network</p>	<p>The AQM 65 wired Ethernet is connected to an existing wired Ethernet network, which could also be a cellular modem</p>

### 3.2.1 Direct WIFI

The AQM 65 can be configured to be a WIFI access point. (The AQM 65 is shipped from Aeroqual factory in this mode). In this mode the AQM 65 will appear in the list of available WIFI networks on a device, as shown in Figure 3-2 The user selects the AQM 65 WIFI network and enters secure access credentials.

Then the user opens a blank window in their internet browser and enters 10.10.0.1 in to the address bar to establish a connection to the AQM 65.

The distance over which the WIFI can be used is about 10 meters. This method of connection is often used by a service engineer when performing routine service or maintenance.

The settings for direct WIFI are shown in Figure 3-7(a).

### 3.2.2 Direct connection using Ethernet cable

An Ethernet cable can be used to directly connect a laptop to the AQM 65. Make sure the blue Ethernet cable is plugged in to the side wall of the AQM 65, as shown in Figure 3-5.



**Figure 3-5 To establish a direct connection, a laptop must be connected to the ePC using an Ethernet cable**

Figure 3-7 (d) shows the communications settings for connection using an Ethernet cable. Note that the Ethernet mode is set to DHCP (server) in this method.

### 3.2.3 Connecting over a local area connection (LAN)

The AQM 65 can be added to a LAN, in two ways:

- Either the AQM 65 uses its WIFI function to connect to a WIFI network
- An Ethernet cable can be used to plug into a router to add the AQM 65 to a LAN.

When this happens the AQM 65 will be automatically be assigned an IP address buy the router.

You must find out what this IP address is so you can connect to the AQM 65. The WIFI or wired LAN IP address will likely be in the format: 192.168.XXX.XXX

Figure 3-4 shows the Aeroqual Connect software with the assigned IP address in the address bar in the browser.

If your laptop also has access to the same LAN, then this IP address can be typed into a browser address bar and a connection to the AQM 65 can be established over the LAN connection.



### 3.2.4 Connecting using a cellular modem

The AQM 65 can be fitted with a MOXA G3111 HSPA cellular modem, shown in Figure 3-6 and has a built in cellular antenna on the outside roof of the enclosure. The modem requires a SIM card and the modem must be configured as discussed in Section 2.3



Figure 3-6 The MOXA modem uses a SIM card and it must be configured for use with the AQM 65

The Ethernet setting must be set to Auto DHCP client to use the MOXA modem, as shown in Figure 3-7c.

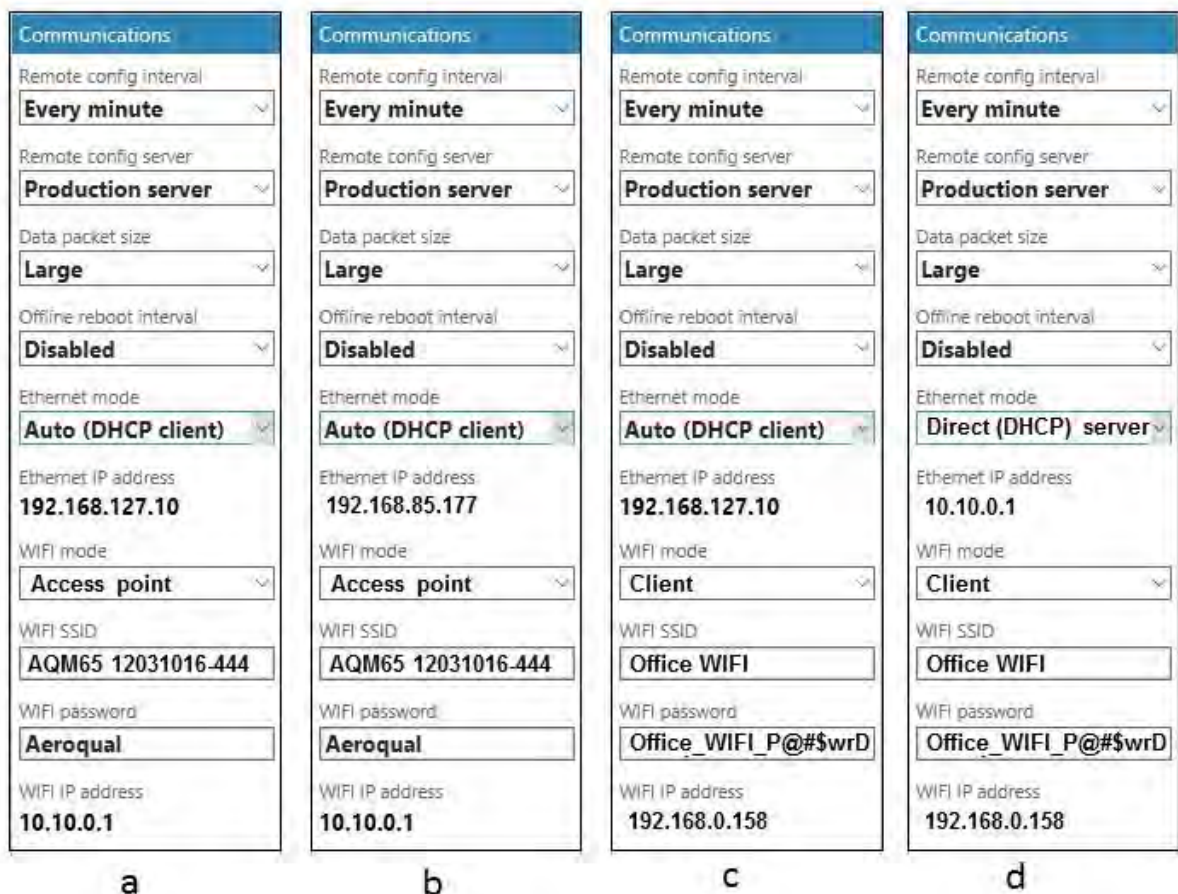

Figure 3-7 The different connection types require different settings in the Configure Instrument app

a)

The Ethernet mode is set to Auto (DHCP client). In this configuration the MOXA modem can be used. The MOXA modem will assign an IP address to the ePC (192.168.127.10)

The WiFi mode is set to Access Point so a direct connection to the EPC can be made over local WiFi



**b)**

The Ethernet mode is set to Auto (DHCP client). In this example the ePC has been plugged in an office router using an Ethernet cable. The router has assigned an IP address to the ePC (192.168.85.177)

The WIFI mode is set to Access Point so a direct connection to the ePC can be made over local WIFI

**c)**

The Ethernet mode is set to Auto (DHCP client). In this configuration the MOXA modem can be used. The MOXA modem will assign an IP address to the ePC (192.168.127.10)

The WIFI mode is set to Client and is connected the office WIFI network. The ePC has been given a WIFI IP address by the router (192.168.0.158). This IP address can be entered directly in the browser to connect to the AQM 65.

**d)**

The Ethernet mode is set to Direct (DHCP Server). In this configuration a laptop can be directly connected to the ePC using a Ethernet cable. Enter 10.10.0.1 to connect directly to the AQM 65.

### 3.3 Resetting the communication settings back to factory settings

The AQM 65 communication settings can be set back to factory defaults.

One situation where this might be useful is if the WIFI SSID name or password has been incorrectly entered and therefore the ePC cannot establish a connection to the local WIFI network.

The WIFI settings can be set back to Access Point mode and the AQM 65 will again appear as a WIFI network with the SSID name “**Aeroqual AQM**” and WIFI password “**Aeroqual**”.

To achieve this you will need a USB flash drive.

1. Create a file on the flash drive called **.resetnetwork.aqm** (yes there is a “dot” at the beginning of the file name).

The file extension must be **.aqm** it cannot be a **.aqm.txt** file.

In Windows OS you can create a new txt document and give the file name **.resetnetwork.aqm**

Check the Type column to make sure it is an **.aqm** file. You might need to unhide file extensions and delete the **.txt** from the end of the file name. Figure 3-8 shows the correct file.

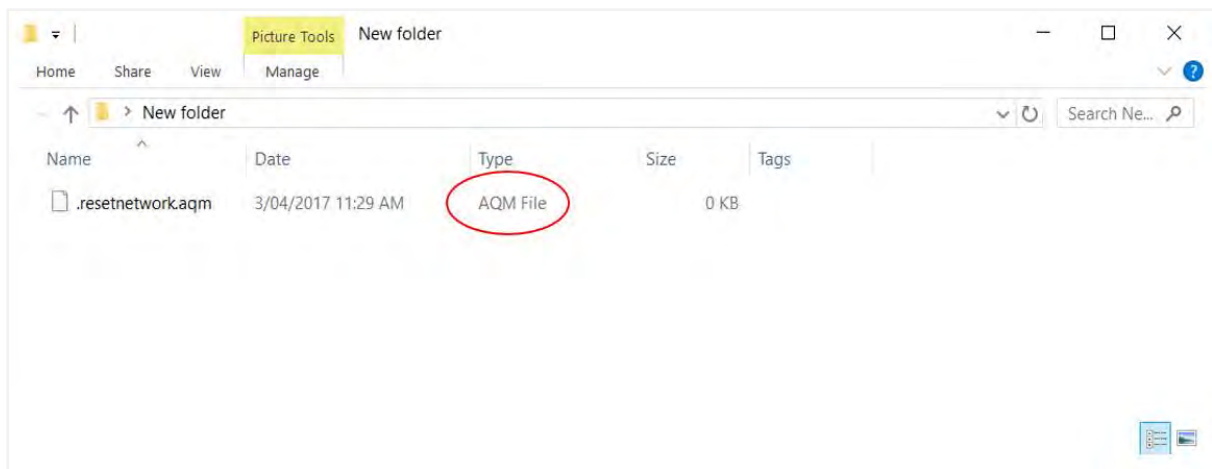

**Figure 3-8 Create an empty file called .resetnetwork.aqm**

Then insert the USB drive into any of the USB ports on the ePC.

Wait several minutes, the ePC will reboot automatically and then you should see a WIFI network appear called “**Aeroqual AQM**” with password **Aeroqual**.

You can then remove the USB stick.

### 3.4 Apps for instrument control and calibration

Data visualisation, instrument configuration, calibration and control of user access is achieved using apps accessible from the main page.

Access to the apps, and the individual features within each app is controlled by the instrument licence and the user privileges for the different user types. These are described in Section 3.5.

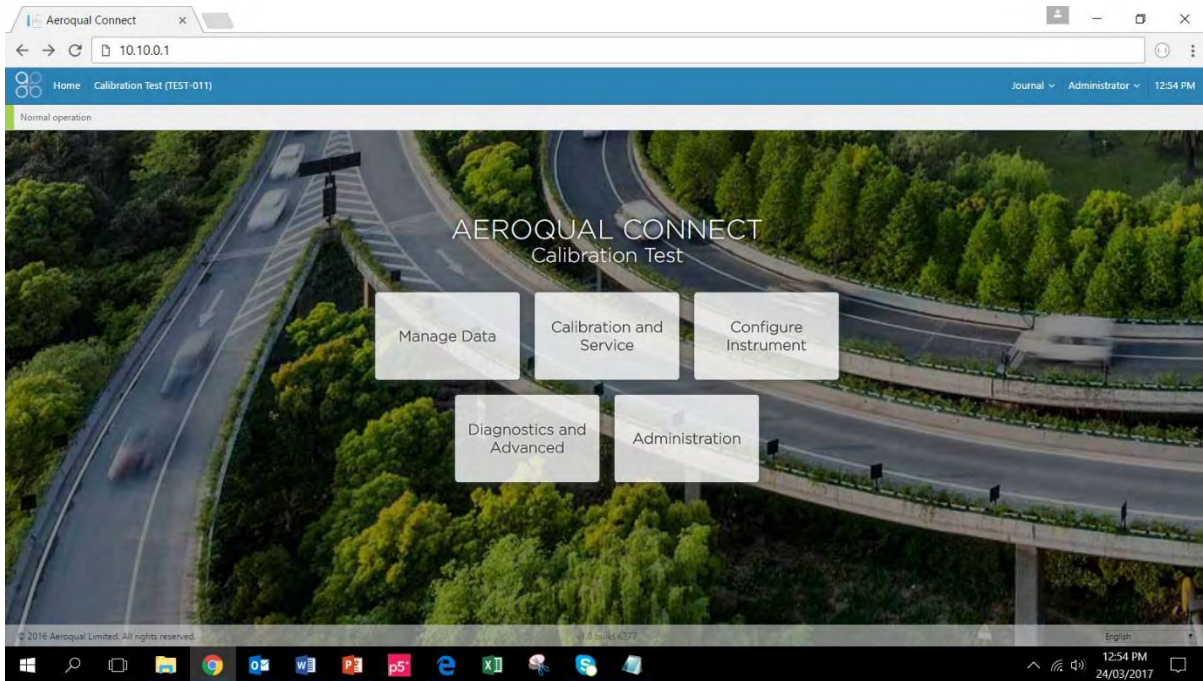

Figure 3-9 The landing page of Connect after login shows the available apps

#### 3.4.1 Manage Data app

The Manage Data app is used to view data within the browser and also to download data (export) for use in other software.

The available features in the Manage Data app will depend up the instrument licence and the user permission level. The features within the Manage Data app appear in a column on the left hand side of the screen.

Feature	Licence required	User permission required
Charts	Connect	User or higher
Table	Connect	User or higher
Download data	Connect	User or higher
Auto Export	Connect + FTP Export	Engineer or higher
Manual sync	Connect	Engineer or higher

Table 3-1 Software tools available to different user permissions

### 3.4.1.1 Charts



Figure 3-10 The charts tool, in the Manage Data app shows each data channel in a stack of charts

### 3.4.1.2 Table

The data from each module can be viewed on screen in a Table. The from and to dates can be selected using a calendar tool, and the averaging period such as daily, hourly or minute can also be selected.

The screenshot shows the 'Table' view of the 'Manage Data' interface. The table displays data for the period from 03/26/2017 to 04/02/2017 with a 1-hour averaging period. The table has columns for Time, O3 (ppm), SO2 (ppm), PM2.5 (µg/m³), ITEMP (°C), TEMP (°C), and RH (%). A dropdown menu for 'Averaging period' is open, showing options: 10 minutes, 15 minutes, 20 minutes, 30 minutes, 1 hour, 2 hours, 4 hours, 8 hours, 12 hours, and Daily. The interface also shows navigation options like 'Charts', 'Download Data', and 'Manual Sync'.

Time	O3 (ppm)	SO2 (ppm)	PM2.5 (µg/m³)	ITEMP (°C)	TEMP (°C)	RH (%)	
4/2/2017 10:00 PM		0.000	1.18	30.0	11.13	47.0	
4/2/2017 9:00 PM		0.001	1.22	30.0	11.19	46.6	
4/2/2017 8:00 PM	0.049	0.003	1.18	30.0	12.33	43.1	
4/2/2017 7:00 PM	0.051	0.003	1.16	30.0	13.60	39.0	
4/2/2017 6:00 PM	0.055	0.001	1.04	30.0	15.70	33.2	
4/2/2017 5:00 PM	0.053	0.001	1.17	30.0	17.25	32.0	
4/2/2017 4:00 PM	0.053	0.001	1.19	30.0	18.07	32.7	
4/2/2017 3:00 PM	0.052	0.003	1.11	30.0	19.75	29.9	
4/2/2017 2:00 PM	0.121	0.053	0.002	1.00	30.0	19.44	29.7
4/2/2017 1:00 PM	0.090	0.051	0.002	0.85	30.0	18.91	33.8
4/2/2017 12:00 PM	0.076	0.050	0.005	0.88	30.0	16.99	40.1
4/2/2017 11:00 AM	0.055	0.047	0.004	0.89	30.0	14.73	46.4
4/2/2017 10:00 AM	0.034	0.045	0.002	0.85	30.0	12.24	52.4
4/2/2017 9:00 AM	0.021	0.040	0.002	0.76	29.9	10.52	58.0
4/2/2017 8:00 AM	0.012	0.038	0.002	0.78	29.9	8.85	63.4
4/2/2017 7:00 AM	0.006	0.036	0.001	0.74	29.9	6.10	73.9
4/2/2017 6:00 AM	0.011	0.015	0.001	1.45	29.9	5.32	80.6
4/2/2017 5:00 AM	0.014	0.013	0.001	1.65	29.9	5.92	81.6
4/2/2017 4:00 AM	0.014	0.020	0.002	1.45	29.9	5.76	81.1
4/2/2017 3:00 AM	0.015	0.021	0.002	1.27	29.9	5.83	81.3
4/2/2017 2:00 AM	0.024	0.024	0.002	0.95	29.9	5.54	79.7

Figure 3-11 The table tool in the Manage Data app shows the data in a table with user configured date range and averaging



### 3.4.1.3 Download data

The data can be downloaded by selecting a From and To date and Averaging Period. The format is comma separated values (.csv). This file format can easily be opened in Microsoft Excel.

The screenshot shows the 'Manage Data' app interface for 'Air Quality Monitor (AQM65 12022016-497)'. The 'Download Data' tool is active, showing a date range from 01/01/2017 to 04/03/2017 with a 1-minute averaging period. Below the app interface, the downloaded data is shown in an Excel spreadsheet titled 'AQM65 12022016-497 Data Export (2).csv'. The spreadsheet contains the following data:

Time	NO2 (ppm)	O3 (ppm)	SO2 (ppm)	PM2.5 (µg)	ITEMP (°C)	TEMP (°C)	RH (%)	Inlet
1/01/2017 0:00	0.006	0.033	0	1.89	29.9	5.92	75.8	Sample
1/01/2017 0:01	0.006	0.033	0	1.78	29.6	5.97	75.6	Sample
1/01/2017 0:02	0.006	0.033	0	1.7	29.7	5.89	74.1	Sample
1/01/2017 0:03	0.006	0.033	0	2.17	30.1	5.95	70.7	Sample

**Figure 3-12** The download data tool in the Manage Data app allows the data to be downloaded at user configured date range and averaging

### 3.4.1.4 Manual sync

The manual sync feature allows all of the data, and diagnostics and journal entries to be **downloaded from Aeroqual Connect to a PC**. The manual sync file cannot be read by any software. The manual sync file is later **uploaded from a PC to Aeroqual Cloud**.

This feature is used if the AQM 65 does not have an active data connection to Aeroqual Cloud at the monitoring site but the data is required to be in Aeroqual Cloud for data storage and so all stakeholders can access the data.

Figure 3-13 shows the Manual Sync download tool in Aeroqual Connect and the Manual Sync upload tool in Aeroqual Cloud.

**NOTE:** You might need to manual sync multiple times. The first time the From Date is 1900, then it creates a file with a maximum number of records of 1 million. Therefore the file might only synchronize for a limited dataset. At the end of that sync the From Date will show up to where the last data was downloaded. You run the sync command again and it gives you a new file starting at that date and including the max number of records. You keep running this process until you get to today's date.

These files are then uploaded one by one using the manual sync upload tool in Cloud.

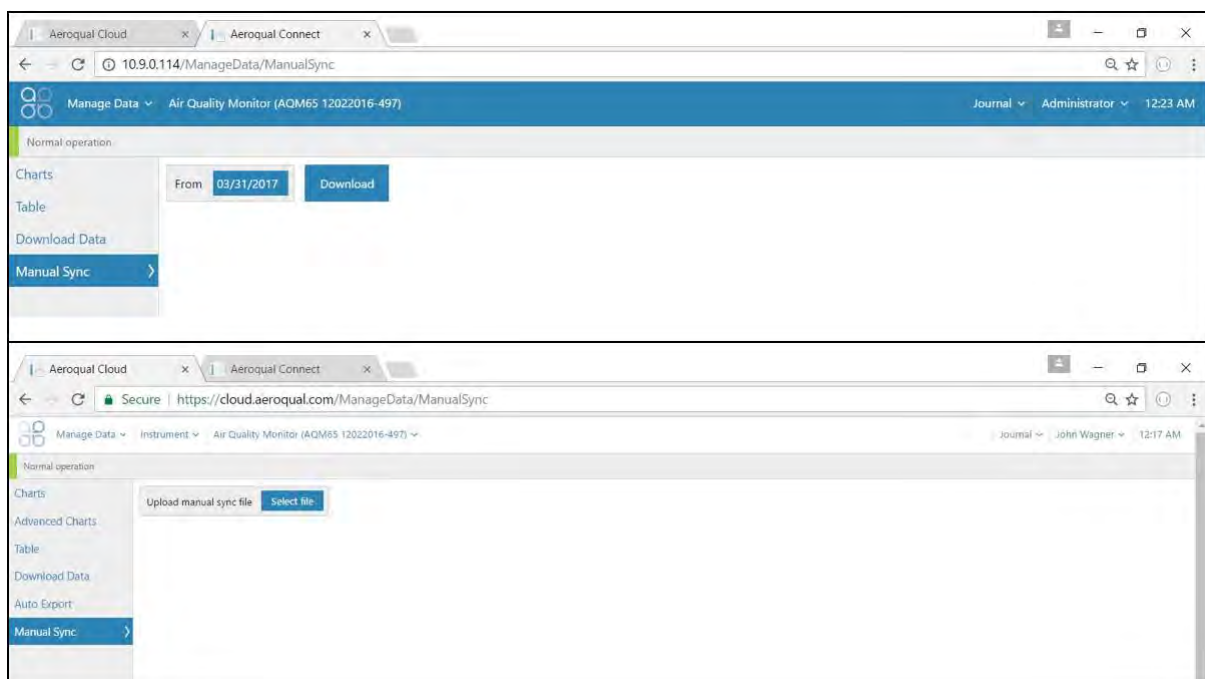

Figure 3-13 The manual sync tool in the Manage Data app allow all data from the AQM 65 to be manually uploaded to the Cloud if a local data connection is not available

### 3.4.2 Service and Calibration app

The Service and Calibration app has three functions, Service mode initiation, changing gain and offset during calibration, and configuring and running the AirCal 8000.

The Service and Calibration app can be accessed by all user types and all instrument licences.

#### Service Mode button

When a service engineer visits the AQM 65 to perform routine service such as filter changes or flow checks, this can cause the data to read very high or very low. During service activities the AQM 65 can be put in to Service Mode by clicking the service mode button. This will tag the data as “service data” which can later be filtered when daily or hourly averages are being calculated.

See Section 4.3.1 for further discussion on Service Mode

#### Gain and offset adjustment

Gain and offset adjustments are made as part of the AQM 65 gas calibration procedure. These adjustments are made in the Service and Calibration App.

#### AirCal 8000

The AirCal8000 is an optional integrated calibration module. The module can be programmed to deliver gas from attached calibration cylinders. Gas can be delivered manually or a schedule can be set to deliver calibration gas automatically.

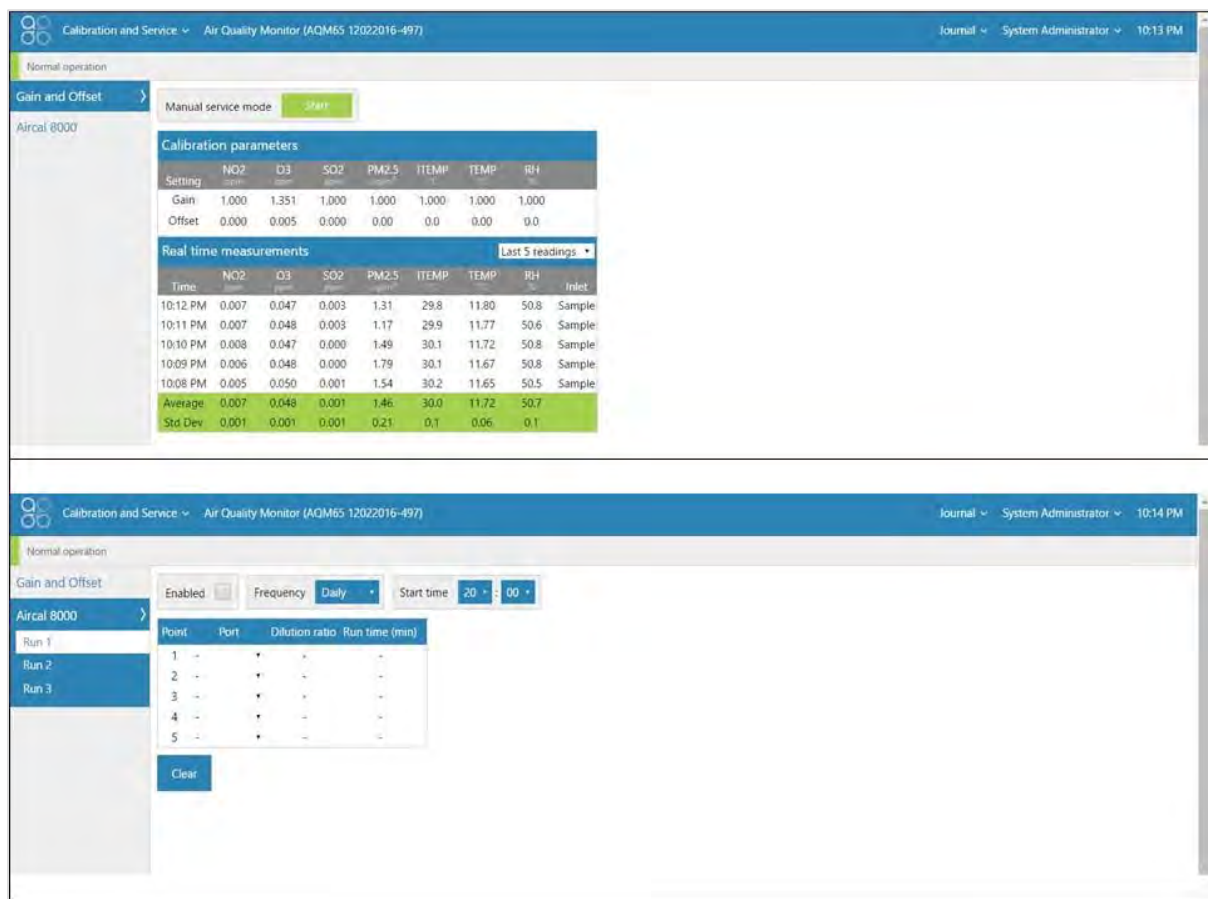

Figure 3-14 The service and calibration app can be used to put the AQM in to service mode, adjust offset and gain settings and control the AirCal 8000

### 3.4.3 Diagnostics and Advanced

The Diagnostic and Advanced app provides to instrument and individual module operating parameters and is used by Aeroqual technical support to troubleshoot and diagnose instrument condition.

The Diagnostic and Advanced app provides real time information about the status of the modules and also allows operational settings of the modules to be viewed or edited.

Licence required: **Connect**

User privilege required: **Engineer or higher**

#### Diagnostics

Each channel can be selected and real time module operation parameters can be viewed.

#### Module settings

Each module has a set of operational parameters that control the module. These can be viewed or edited using the module settings dialogue. These settings should not be changed without instruction from Aeroqual.

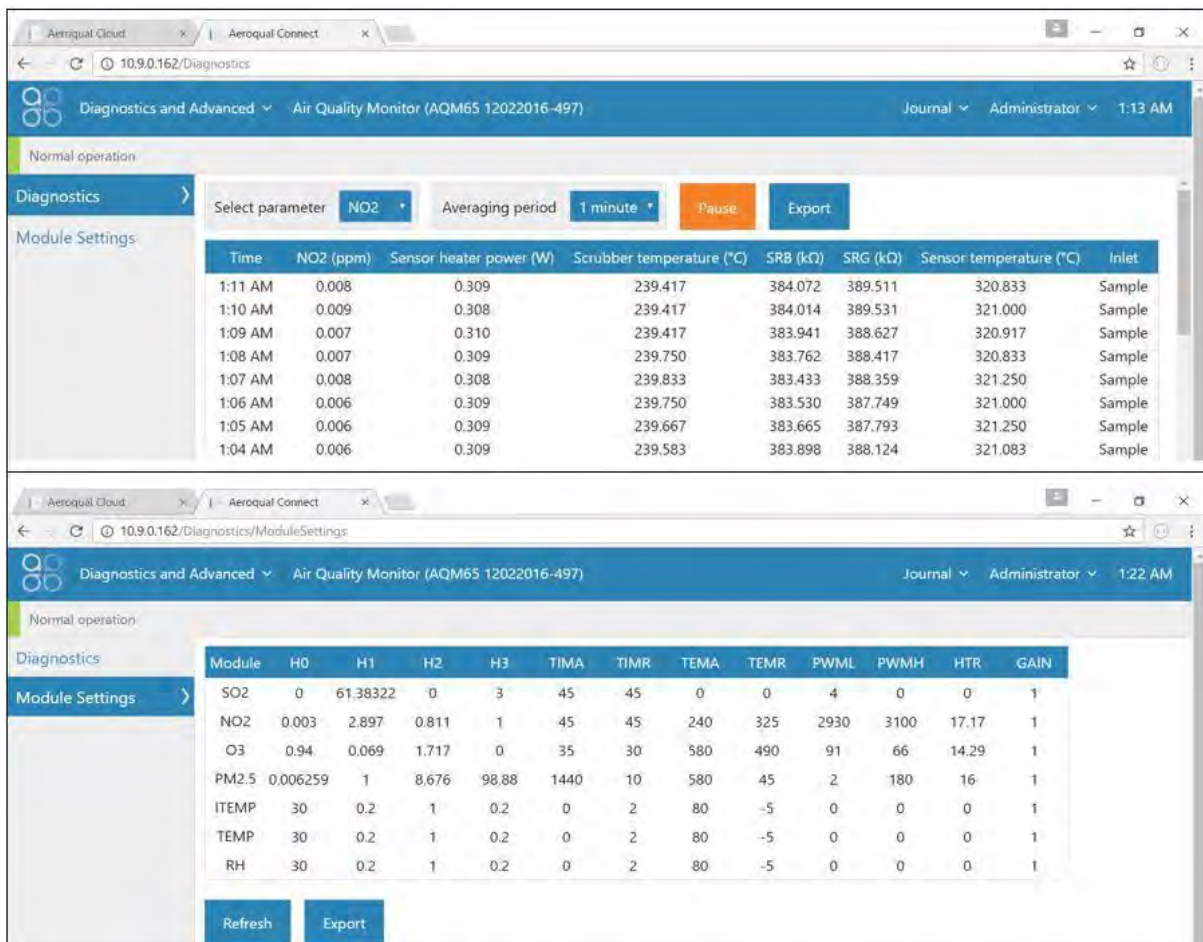

Figure 3-15 The Diagnostics and Advanced app displays real time instrument operational readings and settings which control how the modules are controlled.



### 3.4.4 Checking Instrument licences in the About Screen

The about screen in the Configure Instrument app provides useful information about the AQM 65, including:

- The list of configured licences
- When data was last sent to the Aeroqual cloud database
- How many text alerts remain (note these come from cloud.aeroqual.com not from the instrument)

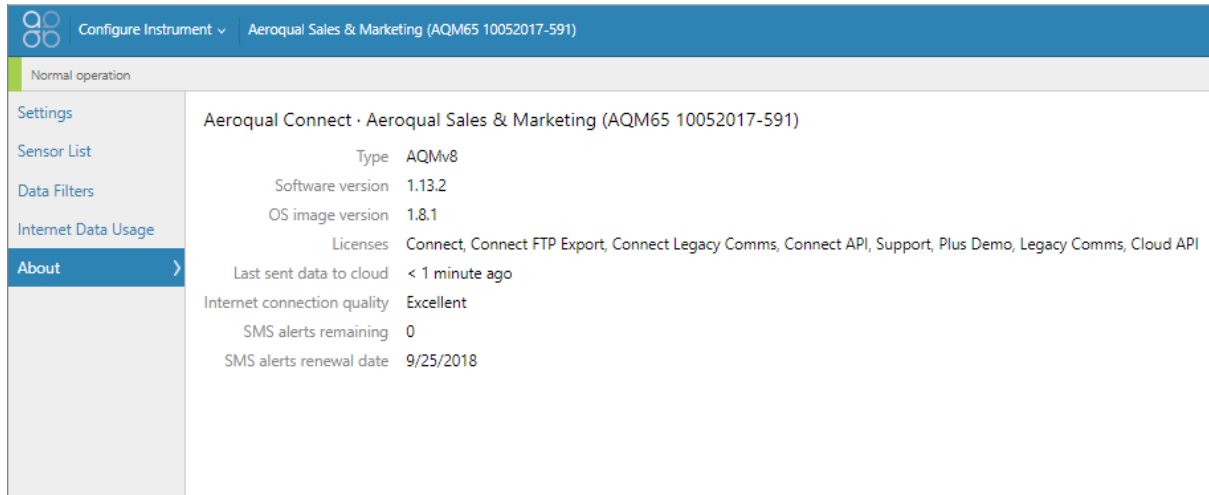

### 3.4.5 Setting measurement units to ppm, ppb, $\mu\text{g}\text{m}^{-3}$ or $\text{mg}\text{m}^{-3}$ , degrees $^{\circ}\text{C}$ or $^{\circ}\text{F}$

Gas measure units can easily be changed from ppm to  $\text{mg}\text{m}^{-3}$  or temperature units between degrees  $^{\circ}\text{C}$  or  $^{\circ}\text{F}$

Go to the Configure Instrument app and click Sensor List on the right hand column.

Click on the measurement channel you wish to change

Click on the “Display Units” drop down list and select your desired measurement unit.

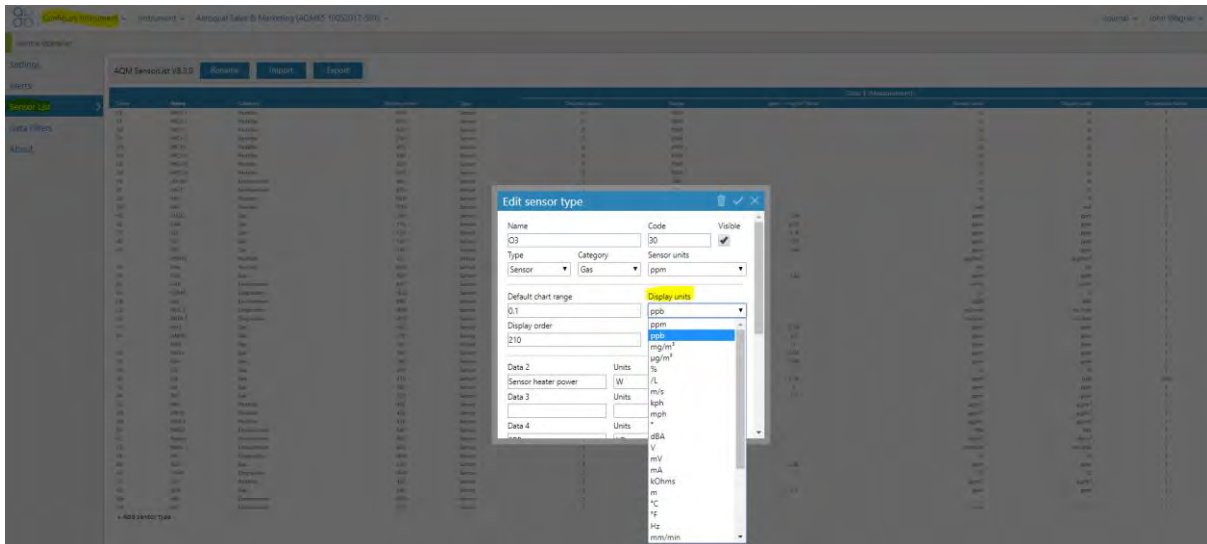

### 3.4.6 Journal

Any changes to instrument settings are automatically recorded in the instrument journal with a date and time stamp and the username of the user who performed the change.

The journal entries are categorised to make it easier to search for specific entries. The categories are selected from the drop down list.

Service activities such as filter replacements or flow checks are not automatically recorded by the software.

Engineers performing service or calibration can make specific user entries to describe their service activities.

**NOTE:** maintaining accurate and complete Journal entries is a pre-requisite of achieving Advanced Engineer status, a certification provided by Aeroqual to distributor engineers. Keeping service records is also a requirement under Aeroqual's factory warranty

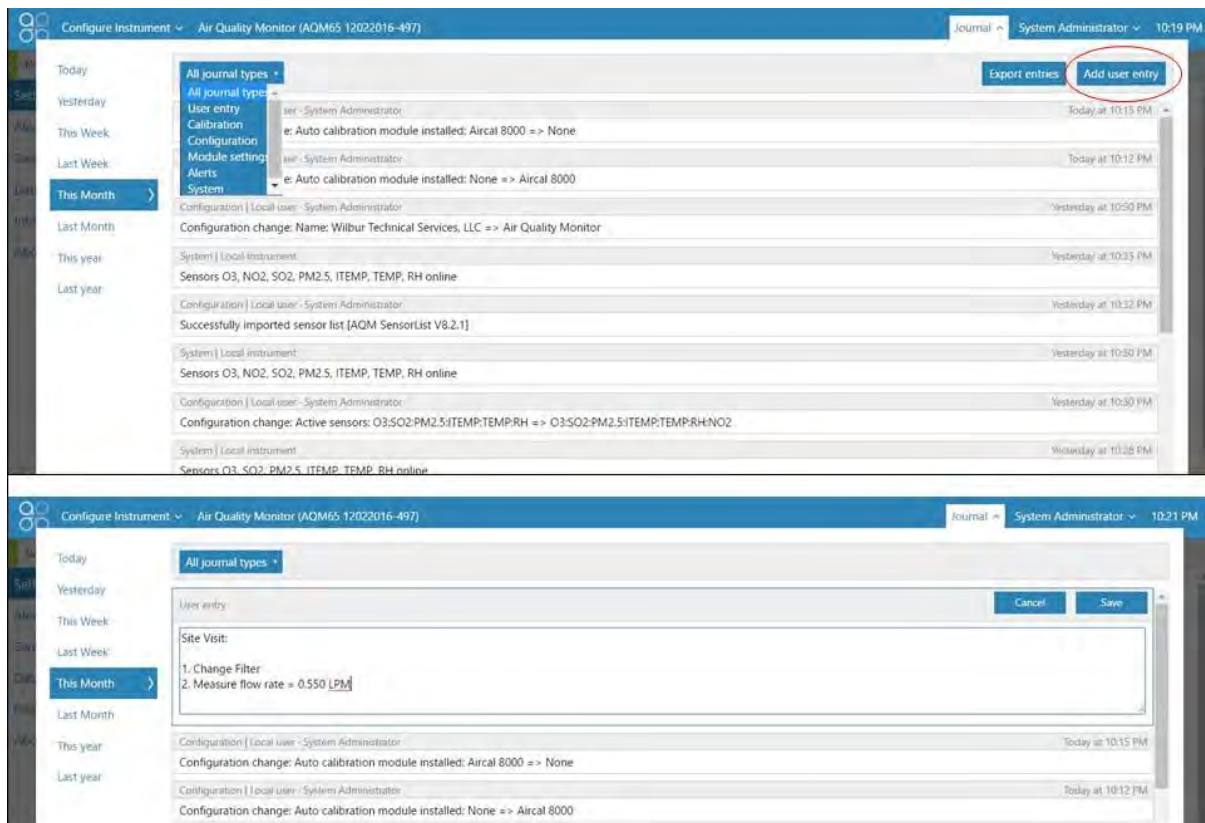

Figure 3-16 The Journal automatically logs software changes, it also allows manual user entries

## 3.5 User permission types: Administrator, Engineer, User and how to create users with secure credentials

Each individual user of the AQM 65 may be given an individual username and password to access the AQM 65. There is no limit to the number of users which can be created.

The AQM 65 ships from Aeroqual factory with a default username and password:

Username: **administrator**

Password: **aqmadmin**

### IMPORTANT!

- ⚠ These access credentials are published in multiple public documents and are only used to first connect to and configure the AQM 65. Aeroqual recommends that a new Administrator user is created with secure password and the default Administrator user is deleted which will make the AQM 65 more secure.

There are different user permissions which can be applied to individual users on the AQM 65.

#### Administrator

- Can control access login and password for other users.
- Has full control over all instrument settings.
- Can view and download data.

An administrator can access all of the apps in Connect, and is the only user type who can access the Administration app, users are created using the Administration app.

#### Engineer

- Has full control over all instrument settings.
- Can view and download data.

An engineer cannot access the Administration app and so cannot create new users.

#### User

- Can view and download data.
- Can perform a calibration and change calibration settings

### 3.5.1 How to create new users and secure the AQM 65

First create a new Administrator user with a secure password. Then default Administrator user should be deleted. Other user types can now also be added.

To get started, go the Administrator app and click on Add user.

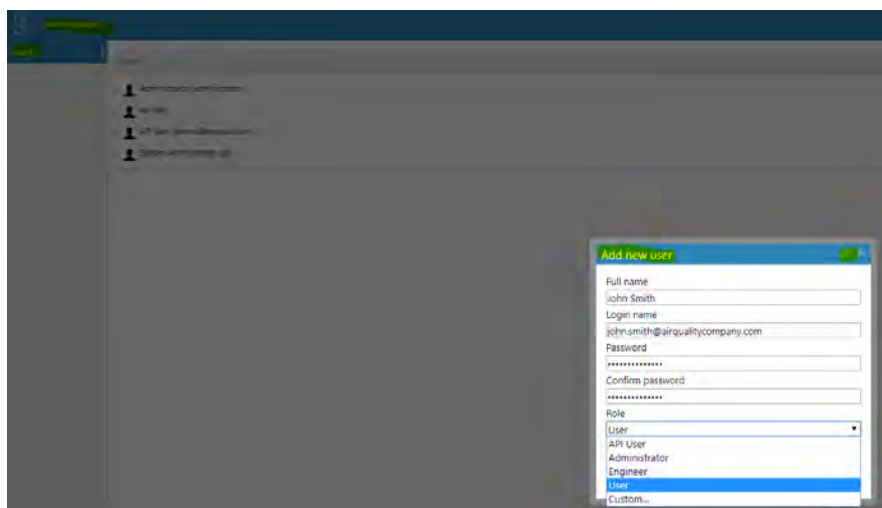



## 3.6 Aeroqual Cloud software features

The software tools in Aeroqual Cloud are almost the same as Aeroqual Connect, some important differences are:

- Text (SMS) and email alerts are sent from Aeroqual Cloud
- Auto Export data (email) is sent from Aeroqual Cloud
- Geo-locate your instrument on a map
- Manage entire networks of AQMs through Aeroqual Cloud

### 3.6.1 Set up text (SMS) and Email alerts

Go to the Configure Instrument app, and click on Alerts in the left hand column

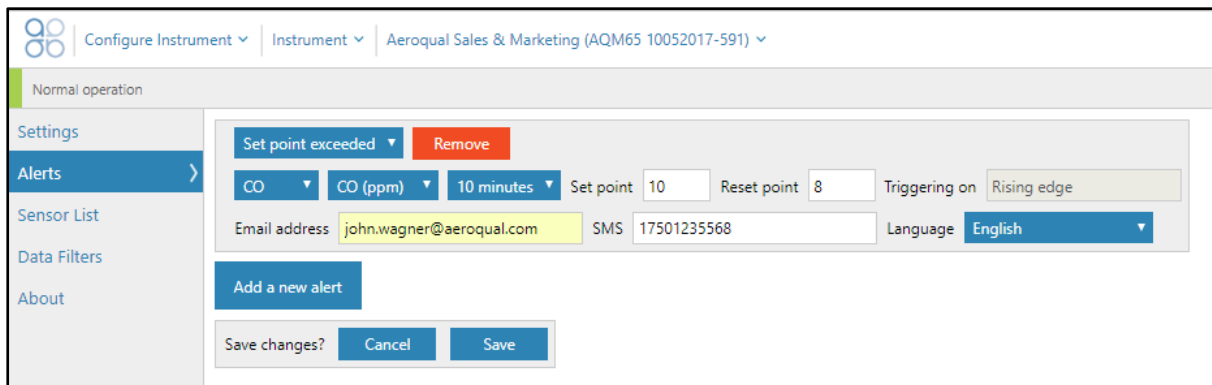

- Choose the type of Alert you want
- Choose the measurement channel you want to Alert on
- Choose the averaging period which will trigger the Alert (in the above example, the Alert is triggered only if the measurement channel values remain at the Alert level for more than 10 minutes, this prevents intermittent spikes triggering the Alert)
- Choose the setpoint for the Alert (the value the Alert is triggered)
- Choose the reset point (this is value which resets the Alert to the off state, and also defines whether the Alert is triggered from a "Rising Edge" or "Falling Edge". A Rising Edge alert is the most common, this means the Alert is triggered when the values rise up and exceeds the Alert level.)

#### Email Alerts

- You can choose to have the Alert sent to an email address.
- You can have multiple email recipients for a single Alert

You can add multiple email addresses with either a ";" or "," separator

bob.smith@company.com,jenny.jones@organisation.co.uk,mickey.mouse@disney.com

#### Text Alerts

- You can choose to have the Alert sent to a cell phone number
- You can have multiple cell phone numbers for a single Alert

You can add multiple text alerts with either a ";" or "," separator

**Do not use any () or + symbols and do not use the leading 00 for international numbers:**

**Start with the country code, then the local number eg 64023445671**

- Check your Text usage in the About Section of the Configure app.

### 3.6.2 Create Organisations, networks, and users in Aeroqual Cloud

The Administration app is where you can set up customer's organisations, create networks and create users.

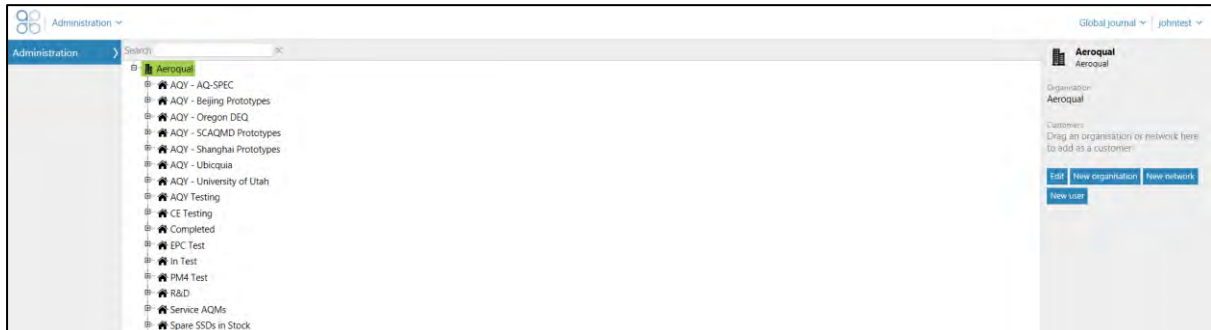

- An Organisation is a company name e.g. "Air Quality Consultants Ltd"
- A 'network' might be a short term project, run by Air Quality Consultants Ltd (AQC) like: "Highway construction project" The Company AQC might have several projects underway, and each can be run as a separate network.
- Users can be created and assigned to Organisations: This means that users can see all instruments in that organisation and in all of the networks under that organisation.
- Users can be created and assigned to a network only, which means these users only see instruments in that network.
- Instruments like the AQM 65 can be placed under an Organisation or under a network.

The controls for creating Organisations, Networks, and Users are on the right-hand side of the Administration panel.

Users, or Instruments can be "click and dragged" in the main window to move them between different networks or Organisations.

	Online video	Aeroqual Cloud Administration App
---	--------------	-----------------------------------

## 4 Maintenance and service

Routine service and maintenance is required to ensure the AQM 65 performs optimally and to fulfil the requirements of the Aeroqual factory warranty.

The frequency of some service activities such as filter changes will depend upon local environmental conditions. Environments with higher particle concentrations, for example, will require more frequent filter changes.

Other service activities such as flow checks and pump replacements can be scheduled at routine intervals. Service activities such as module replacements are performed only when required.

Recommended service frequencies for each service activity are given in Section 4.6.

Further detail on each of the service activities can be found on the Aeroqual training website:

[training.aeroqual.com](http://training.aeroqual.com) (The training website requires a login, please email [technical@aeroqual.com](mailto:technical@aeroqual.com))

For some of the service activities described a video is also available on [YouTube](#). If a video is available, a web-link will be provided next to this symbol.



It is very important to keep service records. The Journal is used for this purpose. See Section 4.3 for a discussion of use of the Journal for service record keeping.

### 4.1 Safety requirements

Replacement of any part should only be carried out by qualified personnel using only parts from the manufacturer

Surfaces marked with a "Caution, Hot Surface" and an internationally recognised symbol may get hot and deliver burns

If installed, the 80180 Particle Monitor is a Class 1 laser product and is not considered dangerous if used correctly. It should not be powered up with the cover removed.

## 4.2 Gas flow meters and flow measurement

Accurate and precise flow rate measurement is critical for AQM 65 service and calibration. Flow rates can be measured and reported in a number of different ways. It is important to understand the terminology and equipment associated with flow rate measurement.

Aeroqual recommends either the Bios Defender DryCal or the Aeroqual R7 flow meter, these can both be used to measure gas flow and Particle Monitor flow.

Aeroqual measures standard flow; the Aeroqual standard conditions are 21.1 °C and 101.3 kPa.



Bios Defender DryCal 0.05 – 5.0 LPM



TSI 4140 (Aeroqual part number R7)

**Figure 4-1 A high quality flow meter is required for gas flow measurement of the AQM 65. Aeroqual recommends the Bios DryCal or the TSI 4140 (AQM R7)**



## 4.3 AQM 65 Service mode and using the Journal to document service

### 4.3.1 Manual service mode

Performing service work on the AQM 65 such as changing filters or measuring flow rates can cause the gas or particle readings to fluctuate. It is important to exclude these data from air quality reports. The AQM 65 can be put in to “Manual Service Mode” by pushing the start button in the Calibration and Service app. This will cause the data to be labelled as “service”, normally the data is labelled as ‘sample’. This is illustrated in Figure 4-2 and allows a data analyst to easily filter out service data when performing quality control, calculating hourly or daily averages or writing air quality reports.

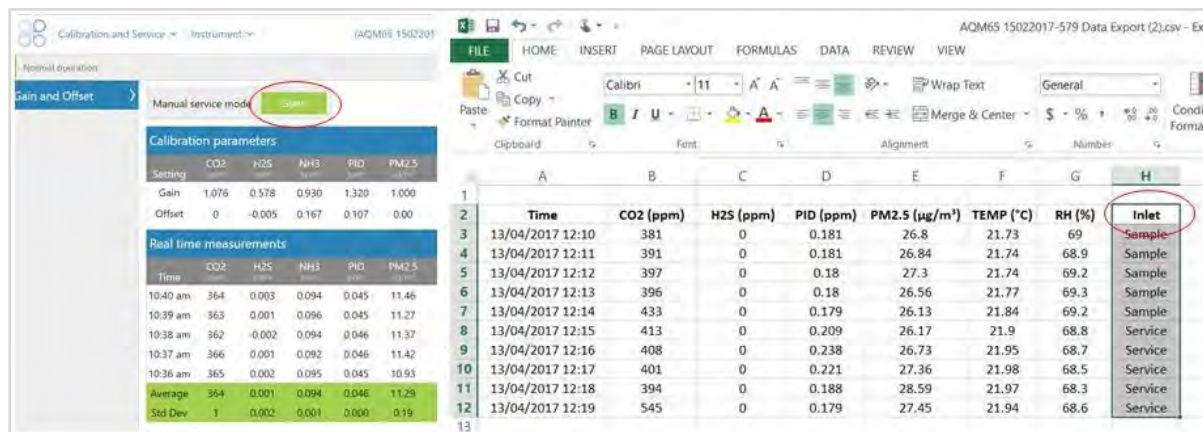

Figure 4-2 The AQM 65 can be put into Service Mode by clicking the button in the Calibration and Service app. This will label the data as "Service" in the inlet column so the data can be filtered.

### 4.3.2 Journal

All service activities should be documented. The Journal is accessed by clicking the Journal button next to the username at the top right of the screen, then selecting user entry.

Your distributor, and the Aeroqual technical support team will look at the journal to see service records when providing advice and technical support.

Maintaining service records is also a prerequisite for achieving and maintaining Aeroqual Advanced Certification Engineer status, see Section 4.7 for a discussion on the certification program.

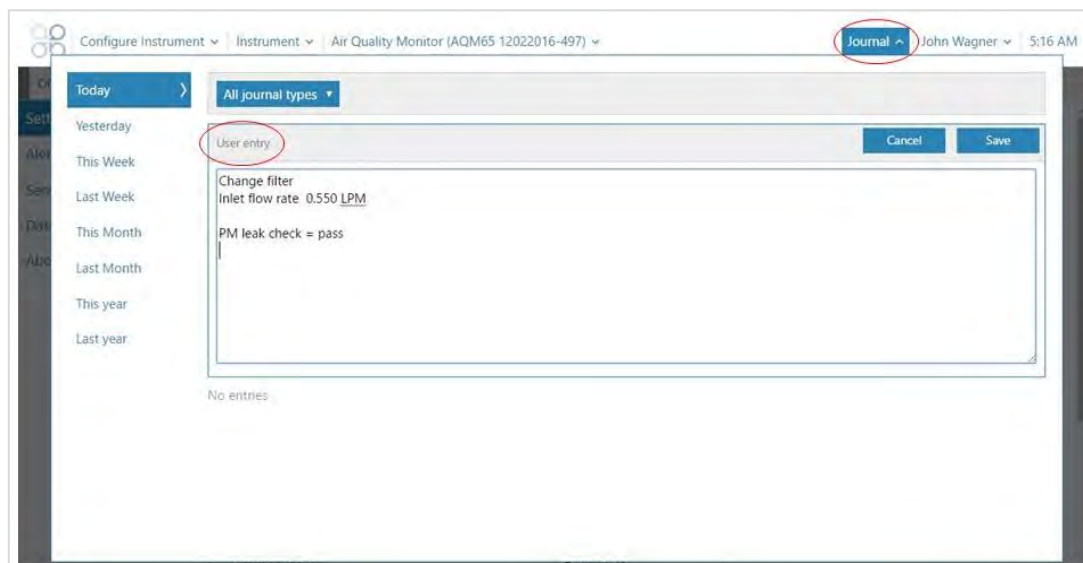

Figure 4-3 All service activities can be recorded in the Journal manually.

## 4.4 List of maintenance procedures

The following section describes all of the common service activities required to ensure good operation of the AQM 65.

Some of the service activities need to be performed regularly such as filter changes and flow checks, and other service activities are performed only as required.

Table 4.1 provides a summary of expected service activities and how often they should be performed.

For each service activity, the tools required are listed and references to additional information on the training website or video website is also given if available.

**NOTE:** Whenever these service activities are performed it is important to record the activity in the Journal using a manual user entry. See Section 4.3.2

### 4.4.1 Tools required for regular service and maintenance

Service and maintenance of the AQM 65 requires basic tools such as Phillips head screw driver and adjustable spanner, and multimeter for checking electrical connections.

The AQM 65 Service Kit (AQM R20) is recommended for maintenance. A description of the components of the service kit can be found on the main page of the training website [training.aeroqual.com](http://training.aeroqual.com).

#### **Recommended tools for regular servicing and maintenance**

Large and small Phillips head screwdriver and large and small flat head screwdriver

Gas flow meter AQM R7 (see section 4.2 for a discussion of requirements for flow meters)

Vacuum gauge AQM R23 (Included in R20 Service Kit also available separately)





Electrical multi meter (Only required for troubleshooting)

Adjustable spanner

#### 4.4.2 Replace gas sample inlet filter

The gas inlet filter is held inside the enclosure at the top left. This must be changed to ensure accurate readings, the filter is disposable and can be thrown away.

The filter should be changed when it becomes dirty as shown in Figure 4-4. The frequency of filter changes depends upon local environmental conditions.

	Tools required	None
	Parts required	AQM R12 (bag of 25 filters)
	Frequency of service	Recommended <b>Monthly</b> (depends on local conditions) See Section 4.6 for further discussion on filter change frequencies.
	Online reference	<a href="http://training.aeroqual.com">training.aeroqual.com</a> : AQM 65 technical Training Section 4.1
	Online video	You Tube Channel: Aeroqual Service and Maintenance playlist

Do not turn off the AQM 65; this procedure can be done with the AQM 65 turned on.

**NOTE:** It is very important to check the AQM 65 inlet flow rate is correct after changing the filter to ensure there are no leaks.

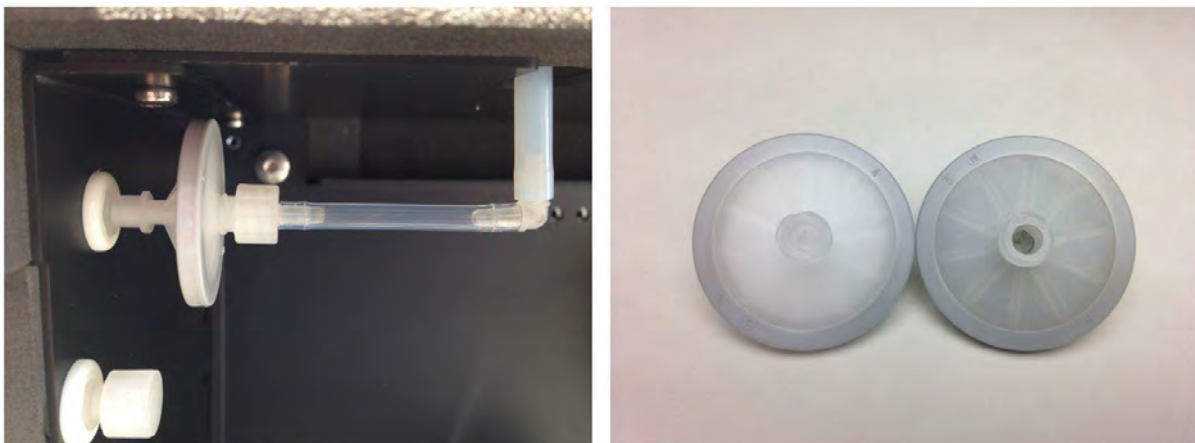







Figure 4-4 The particle filter on the gas inlet can be easily replaced, it should be replaced when it gets dirty as shown in the image on the right. (a new filter is shown on the left, dirty filter on the right)

### 4.4.3 Measure and adjust AQM 65 inlet flowrate and module flow rates

Maintaining a consistent flow rate is very important for ensuring accurate measurements. Leaks, or an aging pump may lead to reduced flow. Regularly measuring the flow rate will ensure any changes to flow rate are identified as soon as possible.

	Tools required	AQM R7, Inlet flow adaptor (comes with AQM 65 accessories box) Small Philips head screwdriver
	Parts required	None
	Frequency of service	AQM inlet flow rate <b>Monthly</b> . (individual modules as required)
	Online reference	<a href="http://training.aeroqual.com">training.aeroqual.com</a> : AQM 65 technical Training Section 4.2
	Online video	You Tube Channel: Aeroqual Service and Maintenance playlist

#### 4.4.3.1 Measure main gas inlet flow rate

- Remove the white inlet fitting containing the mesh filter and attach the inlet flow adaptor
- Attach a high quality flow meter such as the Aeroqual R7 or Bios Dry Cal. See section 4.2
- Record the inlet flow rate in the Journal by making a manual user entry

The AQM 65 inlet rate is controlled by the number of gas modules installed. Each gas module contributes to the overall flow rate, See Table 1-1 for a description of the expected flow rate for each module.

**NOTE:** The AQM 65 inlet flow rate is equal to the sum of all of the individual flow rates.

When the AQM 65 is new, the inlet flow rate is recorded in the instrument log book which is provided from the Aeroqual factory. This might change, especially if modules are added or removed.

The measured flow rate should be equal to the previously measured flow rate which is recorded in the instrument journal.



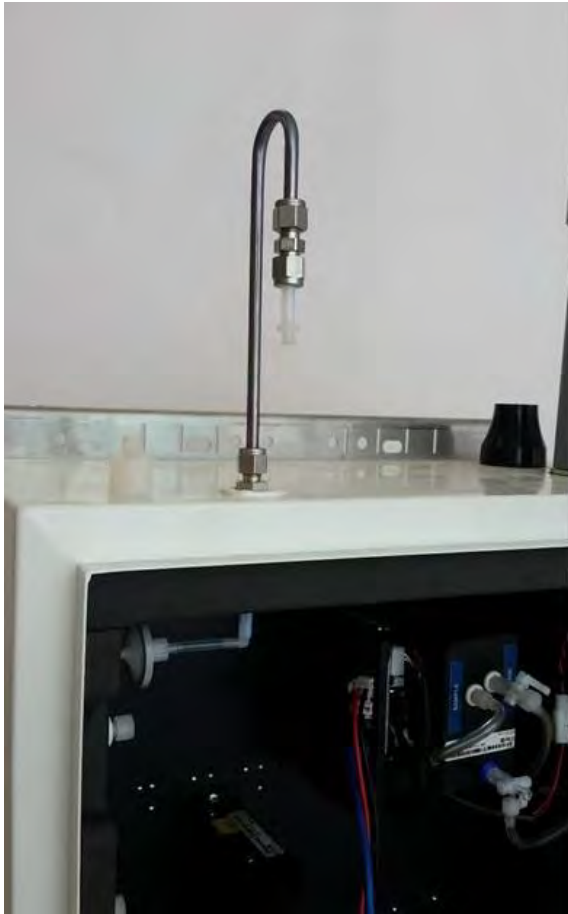

**Figure 4-5** To measure the flow rate, remove the inlet filter and attach the inlet flow adaptor.

#### **4.4.3.2 Measure the flow rate of the individual modules**

The module flow rates are measured using a high quality flow meter such as the Aeroqual R7 or the Bios Dry Cal. See Section 4.2

- Attach the flow meter to the inlet port of the gas module
- Reconnect the inlet fitting after measuring each gas module
- Record the flow rate of each module in the Journal by making a manual user entry



**Figure 4-6** To measure the individual module flow rates, disconnect the gas inlet and attach the module inlet to the vacuum port of the R7 flow meter.

#### 4.4.3.3 Adjust the AQM 65 inlet flow rate and replacement of the gas sample pump.

If the AQM 65 inlet flow rate is found to be lower than expected, it could be because one of the modules has a leak or is blocked.

To check this perform a leak check on the individual modules as described in Section 4.4.10.

If one of the modules is found to be blocked or has a leak then this will need to be corrected.

If all of the modules showed reduced flow, then it is likely that the gas flow pump is aging.

The flow adjustment valve can be used to provide more flow to the module inlets, and return the flow rate to the expected flow rate.

Attach a flow meter to the inlet and begin measuring the inlet flow. Adjust pump flow adjustment valve until the AQM 65 inlet flow rate has returned to the expected flowrate. The valve is shown in Figure 4-7.

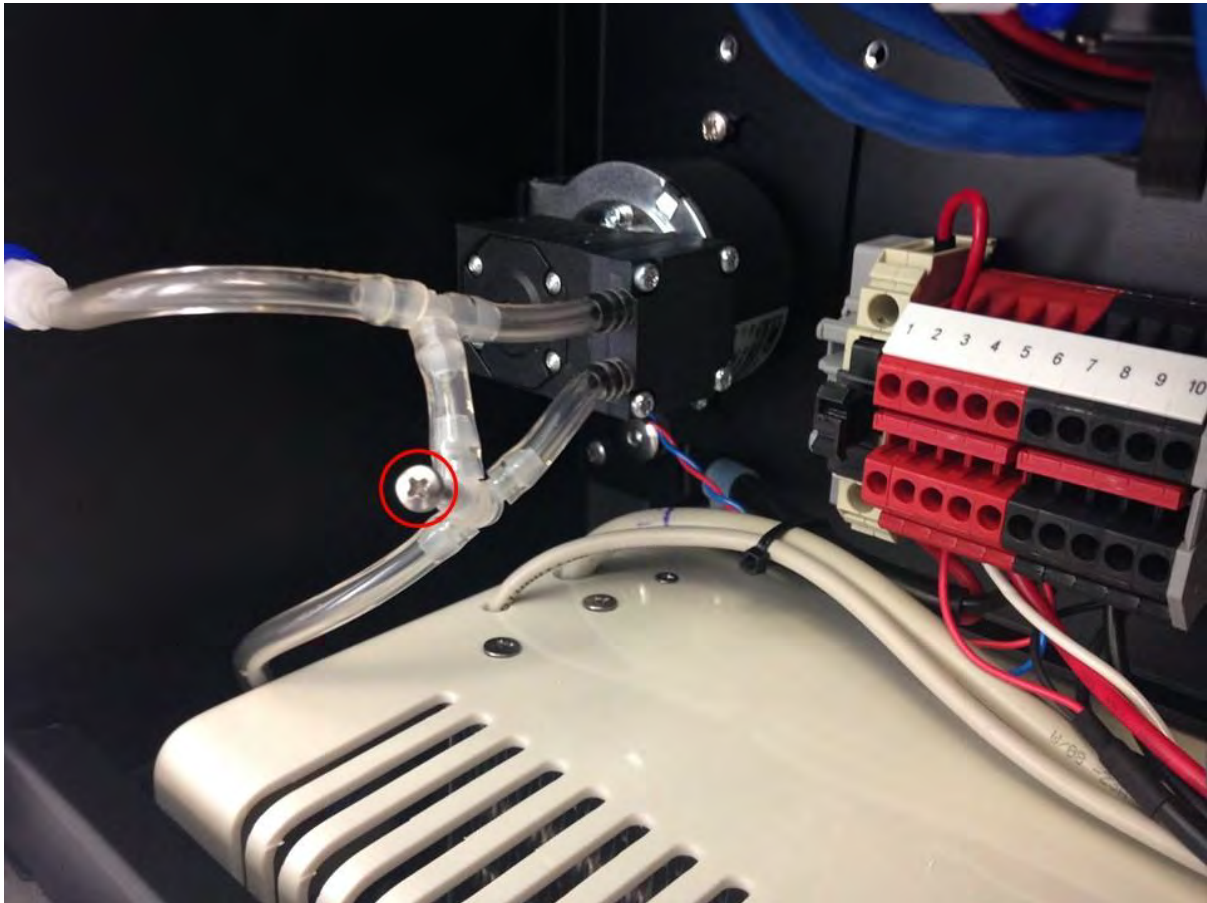







Figure 4-7 The flow adaptor valve is used to adjust the AQM 65 inlet flow to the correct value.

If the correct flow rate cannot be set then it may be required to replace the gas sample pump. The pump is part number **AQM R10**. The pump can easily be removed from the bracket for replacement. It is important to use fresh Tygon Tube (CS Tube 10) when re-connecting the tube back on the pump. This is because the barbs on the pump stretch the tube.

The online training website contains details on how to replace the gas sample pump.

#### 4.4.4 Replace filter on Particle Monitor or Particle Profiler

The Particle Monitor and Particle Profiler have filters which need to be replaced. Disconnect the pump module power when replacing the filter, see Figure 4-14. and Figure 4-15.

	Tools required	Large flathead screwdriver
	Parts required	AQM R32 (Particle Monitor) AQM R32 Particle Profiler
	Frequency of service	Recommended <b>Monthly</b> (depends on local conditions) See Section 4.6 for further discussion on filter change frequencies.
	Online reference	<a href="http://training.aeroqual.com">training.aeroqual.com</a> : AQM 65 technical Training Section 4.3
	Online video	You Tube Channel: Aeroqual Service and Maintenance playlist

The filters for the Particle Monitor are located inside the optical module. Use a large flat head screw driver to unscrew the filter housing on the front panel of the optical module.

The filters for the Particle Profiler are located in a filter casing outside the optical module. These are held by compression fittings which are easily removed.



AQM R31 for particle monitor



AQM R32 for particle profiler

Figure 4-8 The Particle Monitor (shown on the left) requires AQM R31 and the Particle Profiler (shown on the right) requires AQM R32

Section 4.6 discusses frequencies for changing the filters on the Particle Monitor and Particle Profiler. However if the filters look visibly blackened they should be replaced, regardless of the time elapsed.

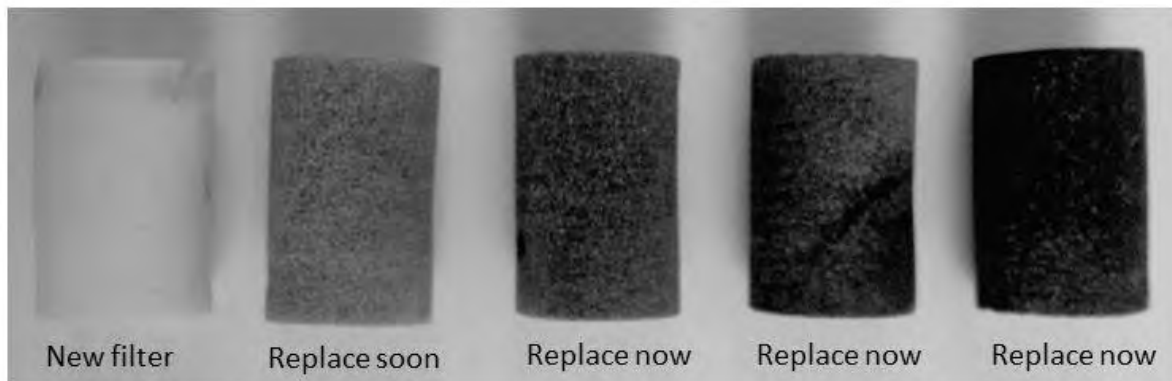







Figure 4-9 The AQM R31 sample filter should be replaced once the filter begins to blacken

#### 4.4.5 Flow check and flow adjustment of the Particle Monitor and Particle Profiler

It is important to maintain the correct flow rate through the Particle Monitor or Particle Profiler. The flow rate of the Particle Monitor and Particle Profiler are different

**NOTE:** The flow rate of the Particle Monitor is  $2.0 \pm 0.05$  LPM  
 The flow rate of the Particle Profiler is  $1.0 \pm 0.05$  LPM

	Tools required	Small Philips head screw driver, AQM R7 AQM R56
	Parts required	None
	Frequency of service	Recommended <b>Monthly</b> . (See Section 4.6)
	Online reference	<a href="http://training.aeroqual.com">training.aeroqual.com</a> : AQM 65 technical Training Section 4.3
	Online video	You Tube Channel: Aeroqual Service and Maintenance playlist

The AQM R56 includes a flow adaptor which is fitted on the inlet, for the Particle Monitor it is fitted above the cyclone as shown in Figure 4-10.





**Figure 4-10** When checking the flow rate of the Particle Monitor (left) place the flow measurement adaptor above the cyclone. The position of the flow adaptor when measuring the Particle Profiler is shown on the right.

#### **4.4.5.1 Using the buffer chamber when checking the flow of the Particle Profiler**

When measuring (or adjusting) the flow rate of the Particle Profiler it is important to use the buffer chamber to ensure accurate measurement. The buffer chamber is part of the AQM R56 Zero Filter and Flow assembly. It is also part of the R20 Service kit. Figure 4-11 shows the buffer chamber installed between the flow meter and the profiler inlet.



The flow buffer chamber smooths the flow coming from the diaphragm pump.

It is installed between the flow meter and the Particle Profiler inlet

**Figure 4-11** When measuring the flow on the Particle Profiler it is important to use the flow buffer chamber

#### 4.4.5.2 Flow adjustment of Particle Monitor

The flow rate of the Particle Monitor must be 2.0 LPM  $\pm$  0.05 (between 1.95 and 2.05 LPM)



Purge valve in fully closed position

Step one: Fully close purge valve

Step two: Adjust exhaust valve until flow rate is 2.2 LPM

Step three: Adjust purge valve until flow rate reads 2.0 LPM  $\pm$  0.05

**Figure 4-12** The flow rate of the Particle Monitor is set by adjusting the purge and exhaust valves

The flow rate of the Particle Monitor must be 2.0 LPM  $\pm$  0.05 (between 1.95 and 2.05 LPM)

- Fully close the purge valve by pushing the valve handle towards the module
- Adjust the exhaust valve until the flow reads 2.2 LPM
- Adjust the purge valve until the flow reads 2.0 LPM  $\pm$  0.05

The final adjustment can be a little tricky, turn the purge valve slowly. If it is not possible to reach 2.2 LPM at step 2 then there may be a leak or the pump might need to be replaced.

#### 4.4.5.3 Flow adjustment of Particle Profiler

**NOTE:** It is important to use the buffer chamber when measuring or adjusting the flow rate of the Particle Profiler. Section 4.4.5.1



Adjust the flow of the profiler using the flow adjustment valve.





The flow rate should be 1.0 LPM

**Figure 4-13** The flow rate of the Particle Profiler is set by adjusting the flow adjustment valve

The flow rate of the Particle Profiler is adjusted to 1.0 LPM  $\pm$  0.05 LPM using the flow adjustment valve as shown in Figure 4-13.

#### 4.4.6 Leak check Particle Monitor and Particle Profiler

If the aluminium inlet is not correctly installed (see Section 2.2.2) or if the tubing is split then the PM can have a leak. The vacuum gauge (AQM R23) is used to check for leaks in the Particle Monitor system and should be performed as part of regular service.

	Tools required	AQM R23
	Parts required	None
	Frequency of service	Recommended <b>Every three months</b> (See Section 4.6)
	Online reference	<a href="http://training.aeroqual.com">training.aeroqual.com</a> : AQM 65 technical Training Section 4.6
	Online video	You Tube Channel: Aeroqual Service and Maintenance playlist

##### 4.4.6.1 Leak check a Particle Monitor

1. Remove the TSP head and install the R23 vacuum gauge above the sharp cut cyclone
2. Fully close the purge valve and fully open the exhaust valve
3. The vacuum gauge should reach at least -60 kPa
4. Then remove power (pull out black and red cable) to the electronics module to turn off the pump.
5. Count how long it takes for the pressure to change by 10 kPa.

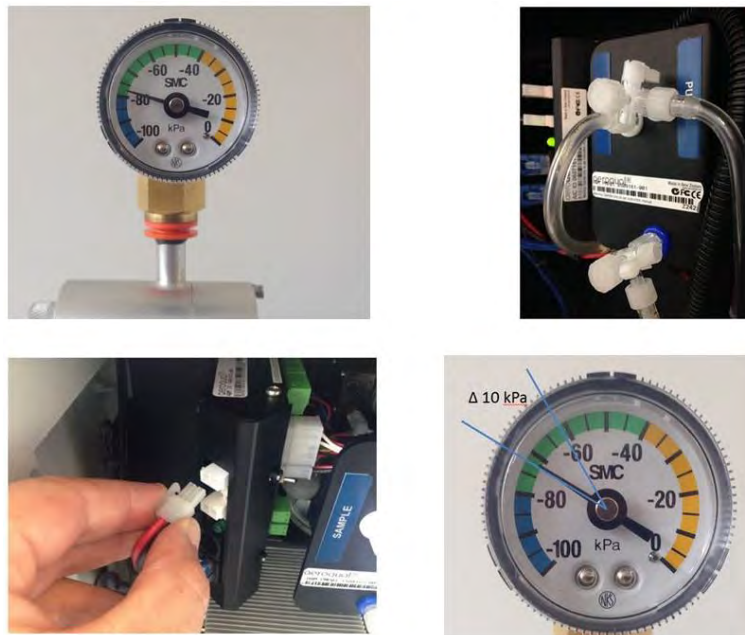

**Figure 4-14** Fit the vacuum gauge, adjust the valves. Then stop the pump by removing power from the module, observe the change in pressure. If the leak rate is greater than 10 kPa in 10 seconds then there may be a leak in the system. Check all the tube connections.

**NOTE:** The pressure change (leak rate) should be no more than 10 kPa in 10 seconds.



#### 4.4.6.2 Leak check a Particle Profiler

1. Fully open the sample valve
2. Disconnect the purge line and cap the purge line and purge port as shown in Figure 4-15 2b If you have the newer pump module, then pinch the tube as shown in Figure 4-16
3. Remove the TSP inlet and place the vacuum gauge on the inlet
4. Wait for the vacuum gauge to stabilise
5. Remove black and red power cable from electronics box







Figure 4-15 Cap the purge and exhaust lines. Place the vacuum gauge on the inlet. Disconnect the power, observe the change in pressure.

**NOTE:** The pressure change (leak rate) should be no more than 10 kPa in 10 seconds



Figure 4-16 Pinch the tube with the newer pump module

#### 4.4.7 Zero calibration check and flow check of Particle Module

	Tools required	AQM R56, AQM R7
	Parts required	None
	Frequency of service	Recommended <b>Every three months</b> (See Section 4.6)
	Online reference	<a href="http://training.aeroqual.com">training.aeroqual.com</a> : Dust Monitor technical training Section 4.4
	Online video	You Tube Channel: Aeroqual Service and Maintenance playlist

##### 4.4.7.1 Check zero baseline of Particle Monitor

The Particle Monitor has an automatic zero calibration function which runs every 12 hours. This procedure automatically changes the zero offset of the Particle Monitor.

The zero response of the Particle Monitor can be checked by removing the TSP head and placing the R56 adaptor and zero filter assembly on the inlet above the cyclone as shown in Figure 4-17. The Particle Monitor should read between  $\pm 3 \mu\text{g m}^{-3}$ .

If the zero check shows negative numbers, there may be a problem with the auto zero cycle. See the troubleshooting section in Appendix 1.

Check that the gain and offset values for the Particle Monitor are set to sensible settings. The gain should be between about 0.6 and 4.0. The offset should be 0.000.

See Section 6 for a discussion on gain adjustment of the Particle Monitor.



Figure 4-17 The zero filter is fitted above the cyclone for a Particle Monitor (left) and directly on the inlet for a Particle Profiler (right)

#### 4.4.7.2 Check the auto zero calibration flow rate of the Particle Monitor

The Particle Monitor (80180) executes an automatic zero calibration every 720 minutes (12 hours). The auto zero process resets a parameter in the module settings. The value that is changed is the H0 parameter.

The Particle Monitor (82850) executes an automatic zero calibration every 1440 minutes (24 hours). The auto zero process resets a parameter onboard the 82850 optical module. The H0 parameter in the module settings does not change.

**NOTE:** The Particle Profiler does not have this feature.

The auto zero procedure on the Particle Monitor causes the baseline to be adjusted. Negative readings on the Particle Monitor are often a result of the auto zero cycle failing to work correctly.

The zero cycle works by switching off the sample pump and switching on a zero pump. The flow rate during the zero cycle is reversed and is a positive flow out through the inlet. The flow rate is approximately 0.2 to 0.6 LPM.

This flow rate does not need to be set to a specific value but it is important that the flow rate is at least 0.2 LPM positive flow out from the inlet.

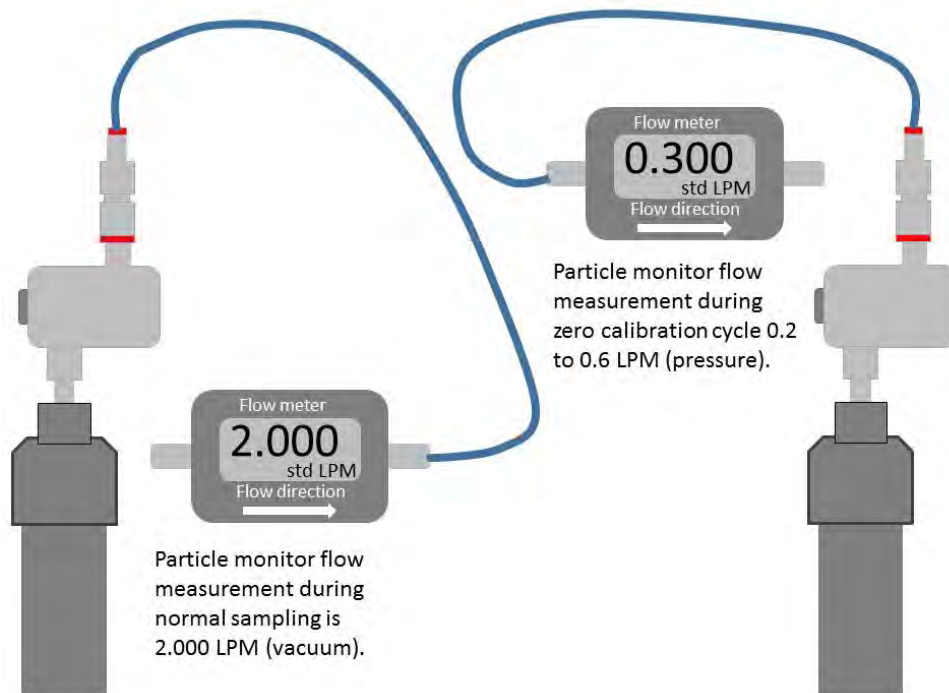

**Figure 4-18** When measuring the sample flow of the Particle Monitor a vacuum is measured. When measuring the zero flow a positive pressure is measured.

The auto zero can be executed manually by temporarily changing one of the module settings. Once the auto zero cycle is complete the setting needs to be returned back to the original setting.

- Go to the Diagnostic and Advanced app in Connect software.
- Select Module settings from the list on the left column
- Locate the Particle Monitor settings, these will be either PM10.0 or PM2.5 or TSP or PM1.0
- Locate the TIMA parameter (it should be 720 if you have the 80180 module).
- Locate the TIMA parameter (it should be 1440 if you have the 82850 module).
- Change this value to 1 by clicking in the cell and typing 1, then save the setting change.

This will cause the auto zero to start. The flow will change from 2.000 LPM negative flow into the inlet to approximately 0.2 to 0.6 positive flow out from the inlet.

You will need to change the port on the flow meter to measure this flow as shown in Figure 4-17.

If no flow is measured there may be an issue with the zero cycle or zero pump. See Appendix 1 for trouble shooting.

- Measure the positive flow coming out from the inlet and record this in the journal.

The zero cycle takes approximately 6 minutes to complete.

**NOTE:** Once the flow has been measured the TIMA parameter must be set back to 720 (80180)

**NOTE:** Once the flow has been measured the TIMA parameter must be set back to 1440 (82850)

### 4.4.7.3 Module settings and diagnostics for the 80180 and 82850 particle monitor

The 82850 optical engine has some difference in the module settings compared

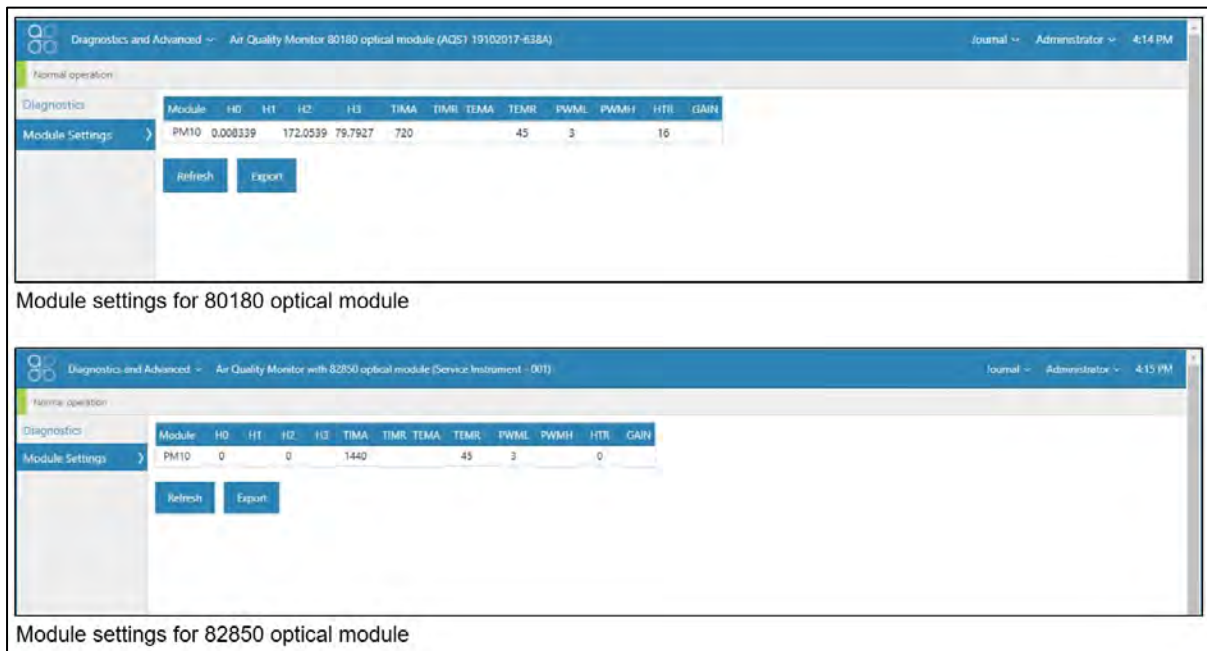

**Figure 4-19 Comparison of module settings between 80180 and 82850 optical modules**

To know which optical module you have see Figure 1-13

Setting	80180	82850
<b>H0</b>	Changes every 12 hours following auto zero	Not used
<b>H1</b>	Not used	Not used
<b>H2</b>	Calibration parameter from Metone certificate	Error status, = 0 (Contact Aeroqual if not = 0)
<b>H3</b>	Calibration parameter from Metone certificate	Not used
<b>TIMA</b>	Auto zero calibration interval	Auto zero calibration interval
<b>TIMR</b>	Not used	Not used
<b>TEMA</b>	Not used	Not used
<b>TEMR</b>	Heated inlet setpoint temperature	Heated inlet setpoint temperature
<b>PWML</b>	Size selection cyclone setting see section 4.4.7.4	Size selection cyclone setting see section 4.4.7.4
<b>PWMH</b>	Not used	Not used
<b>HTR</b>	Not used	Not used
<b>Gain</b>	Not used	Not used

**Table 4-1 Description of module settings for 80180 and 82850 optical modules**

- The 82850 optical module will report error codes in the **H2** module settings parameter, contact Aeroqual if this value is anything other than 0



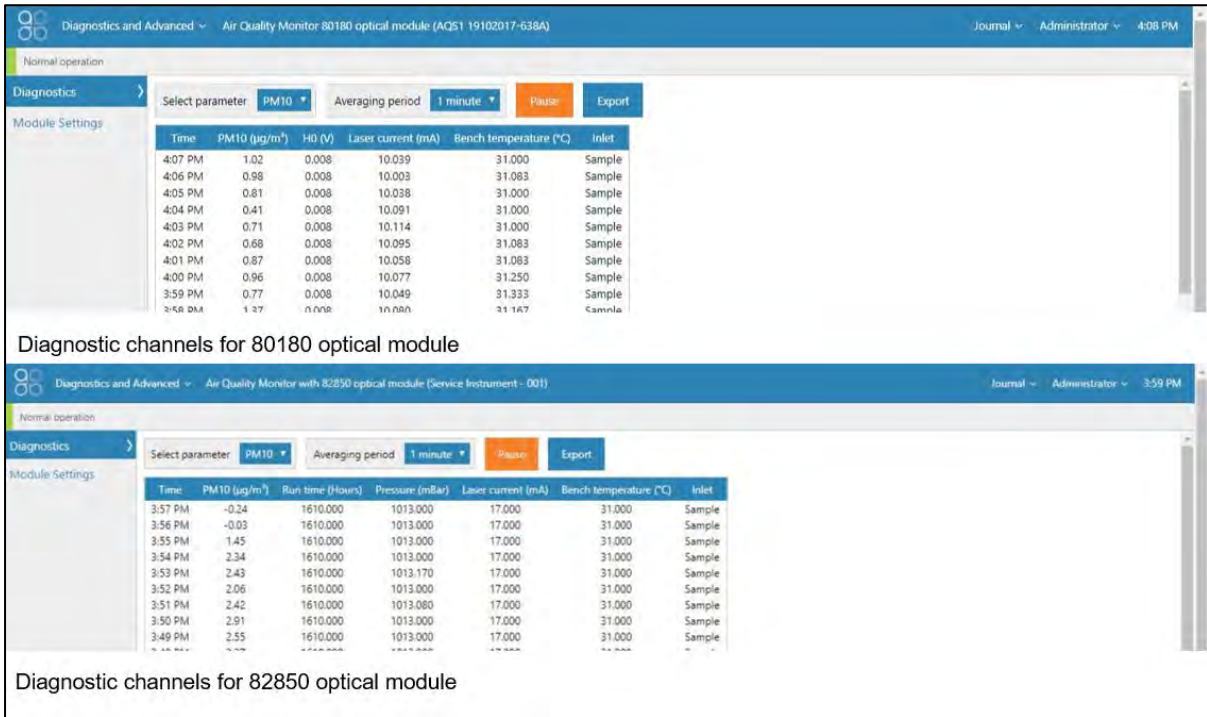

Figure 4-20 Comparison of diagnostic channels between 80180 and 82850 optical modules

Diagnostics for 80180		Diagnostics for 82850	
<b>PM (ugm-3)</b>	The PM concentration	<b>PM (ugm-3)</b>	The PM concentration
<b>H0 (V)</b>	The value of the analogue signal during last zero cycle	<b>Run Time (Hours)</b>	Hours of operation of 82850 module
<b>Laser current (mA)</b>	Should be similar to laser current stated on certificate	<b>Pressure (mBar)</b>	Atmospheric pressure
<b>Bench temperature</b>	Inlet heater turns off when temp gets above TIMR	<b>Laser current mA</b>	Should be similar to laser current stated on certificate
<b>Inlet</b>	Will report Sample, unless in service mode	<b>Bench temperature</b>	Inlet heater turns off when temp gets above TIMR
		<b>Inlet</b>	Will report Sample, unless in service mode

#### 4.4.7.4 Changing the sharp cut cyclone in the software 80180 and 82850 optical module

When changing the cyclone between different size fractions Figure 1-12 two changes must be performed in the software:

1. Initial configuration is PM10

2. Then add PM2.5, do not remove PM10 yet, PM2.5 will show offline

3. Then open up the module settings, you will see both PM sizes.

4. Then change the PWML setting to 2

5. Go back to Configure, after a few minutes the PM10 will show offline, then remove PM10 from the configuration

Figure 4-21 Changing the size designation in the software

The PWML setting in the module settings controls the which PM size fraction is recorded in the software.

PWML 4 = TSP

PWML 3 = PM 10

PWML 2 = PM2.5

PWML 1 = PM1.0

To change the cyclone setting:

1. Add the new size fraction in the Configure app (do not remove the old size yet). The new size will show up as offline initially.
2. Then look at the module settings, change the PWML setting for the **original** size fraction
3. Then go back to Configure App, after several minutes the original size will show offline
4. You can now remove the original size from the Active sensors list.

#### 4.4.7.5 Check the zero baseline of the Particle Profiler





The Particle Profiler does not include an automatic zero cycle.

The zero response of the Particle Profiler can be checked by removing the TSP head and placing the R56 adaptor and zero filter assembly on the inlet as shown in Figure 4-17. The Particle Profiler channels should read between  $\pm 3 \mu\text{g m}^{-3}$ .

If the readings are above this value then it is possible the optic engine needs cleaning. Contact Aeroqual technical support for further advice.

#### 4.4.8 Clean the Particle Monitor TSP inlet, particle trap and cyclone.

The Particle Monitor cyclone uses a small particle trap to remove larger particles. The trap needs to be emptied and cleaned for optimum operation of the Particle Monitor. If the particle trap overfills then the entire cyclone needs to be cleaned.

	Tools required	Can of compressed air, Cloth
	Parts required	None
	Frequency of service	Recommended <b>Every three months</b> . (See Section 4.6)
	Online reference	<a href="http://training.aeroqual.com">training.aeroqual.com</a> : AQM 65 technical Training Section 5.1
	Online video	You Tube Channel: Aeroqual Service and Maintenance playlist

The TSP head, particle trap and cyclone disassemble easily for cleaning



Figure 4-22 The TSP head and cyclone can be disassembled for cleaning

#### 4.4.9 Replace pumps in pump module

The pumps in the Particle Monitor pump module and in the Particle Profiler pump module can easily be replaced.

The Particle Monitor contains a sample pump (AQM R10) and a purge pump (AQM R34). The Particle Profiler only has a sample pump (AQM R10)

Typically the pumps last between 12 and 18 months. However the pumps should be replaced when the correct flow can no longer be maintained.

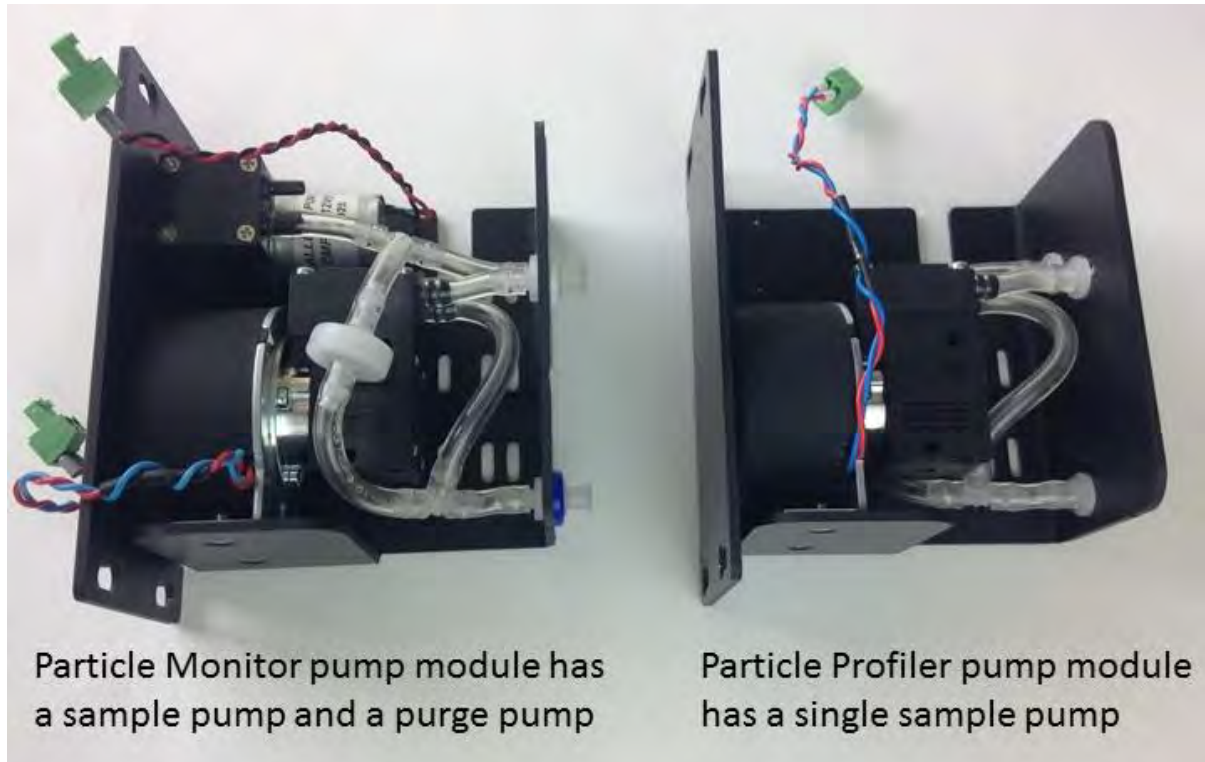





Figure 4-23 The Particle Monitor contains two pumps; the Particle Profiler has one pump

#### 4.4.10 Leak check gas module

If the correct flow rate cannot be achieved through a gas module, this may indicate a leak. An individual gas module can be checked for leaks by using a small diaphragm pump and a flow meter in the configuration shown in Figure 4-24

	Tools required	Diaphragm pump AQM R10 , AQM R7
	Parts required	Luer cap
	Frequency of service	As required. (See Section 4.6)
	Online reference	None

A gas module should be leak tight.

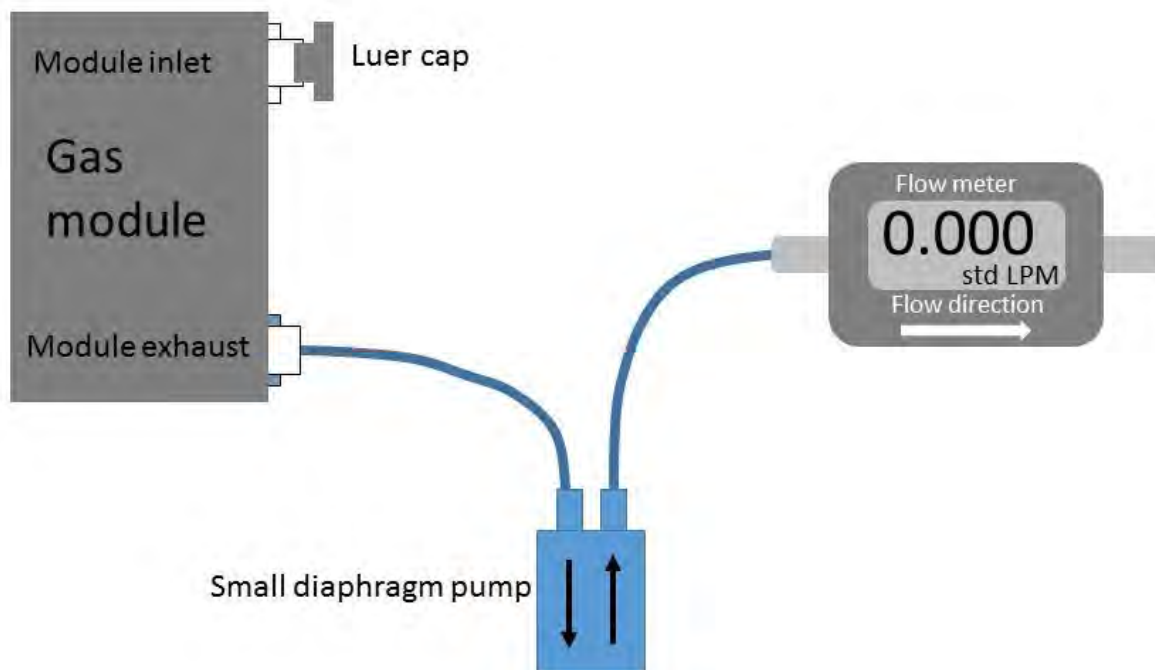

Figure 4-24 A gas module can be checked for leaks by using a diaphragm pump and R7 flow meter





If the module is found to have a leak, contact Aeroqual technical support [technical@aeroqual.com](mailto:technical@aeroqual.com) for further support.



#### 4.4.11 Add, remove or replace a gas module

Changing the module configuration can be done easily on site at the monitoring location. Module replacement can be done with the AQM 65 power on.

A change in the module configuration will result in a change of inlet flow rate. It is important to measure the inlet flow rate after the module change and document this in the instrument journal.

	Tools required	Tube Cutter, Large Phillips head screw driver, AQM R7
	Parts required	Tubing: CS Tube10 CS Tube11, power cable, communication cable, 2x luer cap
	Frequency of service	As required
	Online reference	<a href="http://training.aeroqual.com">training.aeroqual.com</a> : AQM 65 technical Training Section 5.2
	Online video	You Tube Channel: Aeroqual Service and Maintenance playlist

If a module is removed or added then a software change is required. The software module configuration can be found in the configure instrument app. Sensor modules can be added or removed using this tool, shown in Figure 4-25.

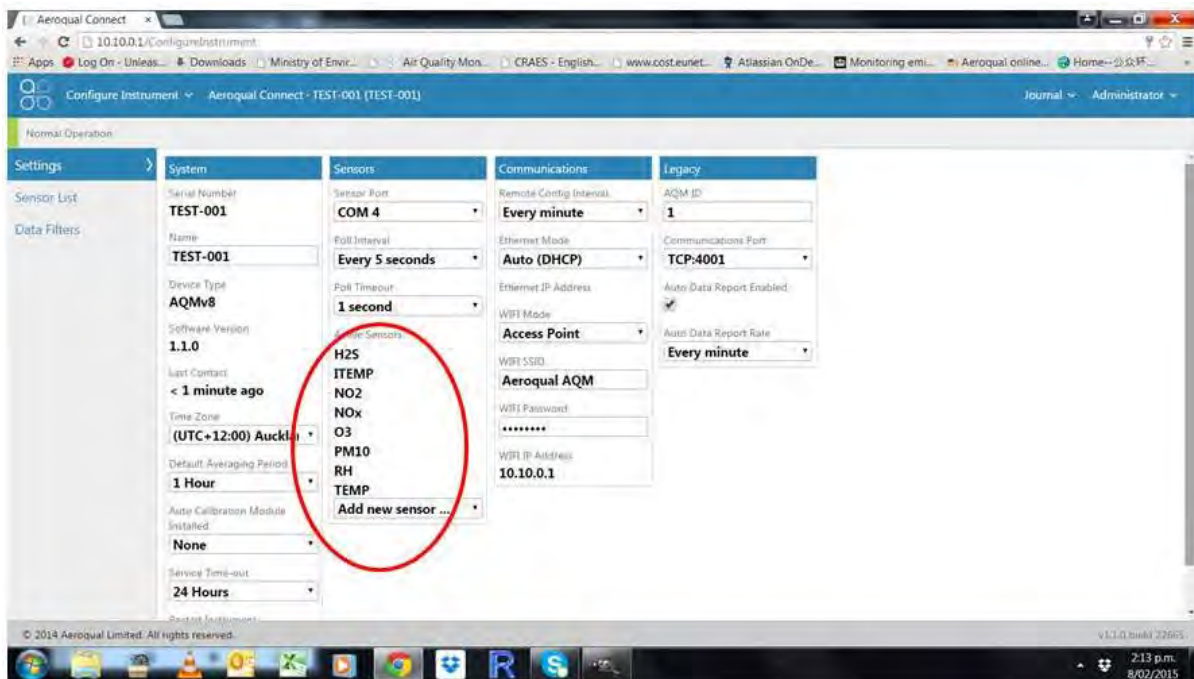

Figure 4-25 Change the module configuration in the software in the configure instrument app

It is important when adding or replacing a module that the offset and gain be set back to Offset = 0.000 and gain =1.000, do this in the calibration and service app.

#### 4.4.11.1 Removing a module without replacing it

This can be done with the AQM 65 power left on. There is a software change required when removing or adding a module.

- Disconnect the vacuum and sample lines
- Remove one blue communications cable and one red and black power cable
- Loosen the retaining screws and remove the module
- Reconnect the blue communication cable and black and red power cable to ensure the remaining modules have power and communications.

#### **IMPORTANT!**

⚠ **Make sure the polarity of the red and black cable is the correct orientation.**

- Cap off the vacuum and sample lines using a luer cap
- Remove the module from the sensor list in the software (Configure instrument app)
- Measure the total inlet flow rate and document this in the journal

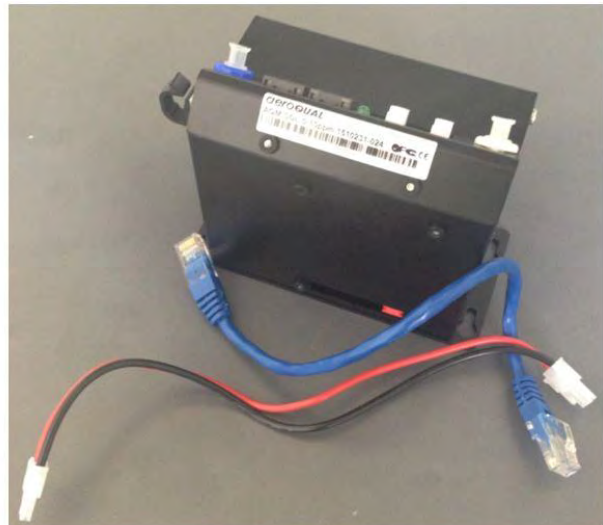
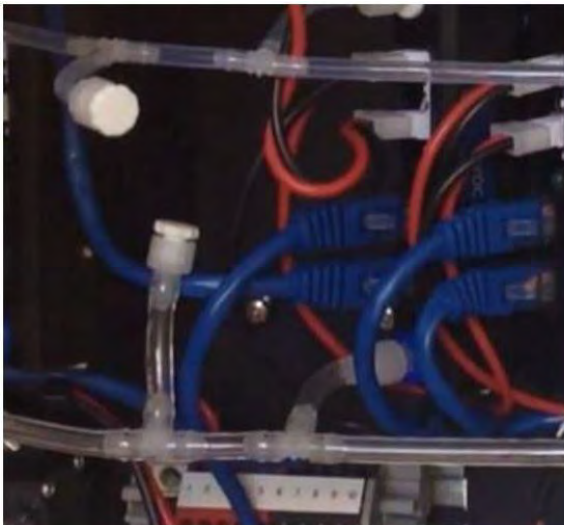

**Figure 4-26** When removing a module, cap the gas lines. You should also remove one communication lead and one power lead.

After you have completed this task you should have two cables left over and the gas lines should be capped off.

**NOTE:** When a gas module is removed the overall inlet flow rate will be reduced. For example if a CO module is removed, then the overall flow rate will be reduced by 0.150 ml per minute.

#### 4.4.11.2 Replacing a module with another of the same type

This can be done with the AQM 65 power left on. There is no software change required when removing a module.

- Disconnect the vacuum and sample lines
- Remove one blue communications cable and one red and black power cable
- Loosen the retaining screws and remove the module
- Replace the module with the new module
- Reconnect the blue communication cable and black and red power cable to ensure all r modules have power and communications.

#### **IMPORTANT!**

⚠ **Make sure the polarity of the red and black cable is the correct orientation.**

- Measure the total inlet flow rate and document this in the journal
- The total inlet flow rate should remain the same.

### 4.4.11.3 Adding a new module

This can be done with the AQM 65 power left on. There is a software change required when adding a module.

You will need one blue communications cable and one black and red power cable.

You need 4 x 10mm M4 screws.

It may be necessary to cut in to the sample and exhaust lines in order to add additional gas fittings. For this you will need a tube cutter. **Do not use scissors.** You will also need tee fittings and luer fitting, and tubing. It may be possible to connect a new module directly to manifold on the left side of the enclosure.

It is important to use the PFA (CS Tube 11) for the gas sampling and Tygon (CS Tube 10) for the exhaust (See Section 1.1.3 for a description of the sample and exhaust manifold).

It is important to use the large barb tee for the exhaust tubing and the small barb tee for the sample tubing.

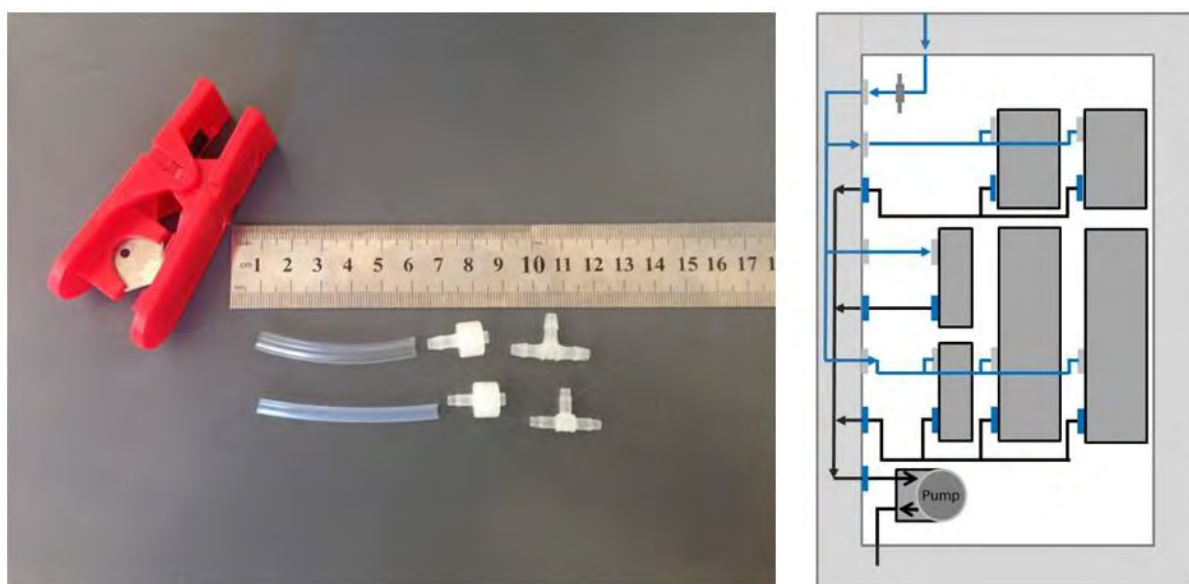

Figure 4-27 Adding a new module requires adding additional sample and exhaust lines.

- Identify the location in the enclosure to install the new module
- Prepare the tubing by cutting sample and exhaust tubing to a suitable length
- If required add a tee (required if you adding a module between two existing modules)
- Secure the module to the back plate using M4 screws
- Add one blue communications cable and one red and black power cable
- Loosen the retaining screws and remove the module
- Connect the blue communication cable and black and red power cable to ensure all modules have power and communications.

#### IMPORTANT!

▲ Make sure the polarity of the red and black cable is the correct orientation.

- Add the module from the sensor list in the software (Configure instrument app)
- Measure the total inlet flow rate and document this in the journal

**NOTE:** The total flow rate of the AQM 65 will increase when adding a module. For example when adding a CO module the total inlet flow rate will increase by  $0.150 \text{ ml min}^{-1}$ .

Record the new inlet flow rate in the journal.





## 4.4.12 Thermal management system, maintenance and troubleshooting

### IMPORTANT!

- ▲ The Thermal management system (TMS) requires maintenance for optimum performance. Loss of internal temperature control can lead to reduced data quality and may damage AQM 65 modules.

The maintenance procedures described here help to ensure optimum performance of the TMS, and avoid loss of thermal control. These procedures can be performed as part of scheduled servicing or as part of a troubleshooting exercise.

The two common procedures are cleaning of the TMS cassette and checking the pressure and refilling of the compressor coolant.

	Tools required	AQM SRVCKT01 Pressure gauge for compressor gas Light brush, Large Phillips head screwdriver,
	Parts required	Refrigerant R134a Must be purchased locally
	Frequency of service	As required. Contact Aeroqual for advice.(Section 4.6)
	Online reference	<a href="http://training.aeroqual.com">training.aeroqual.com</a> AQM 65 Technical Training Section 3.3
	Online video	You Tube Channel: Aeroqual Service and Maintenance playlist

### 4.4.12.1 Changing the internal set point temperature

The internal temperature set point is controlled by the ITemp H0 parameter in the module settings shown in Figure 4-28. The AQM 65 internal temperature is set to a default set point temperature of 30°C.

30 °C is suitable for most environments. For AQM 65s installed in extreme cold or extreme heat, the set point can be changed to reduce the power demand placed upon the thermal management system.

#### Examples:

In very cold climates (e.g. Alaska) where the external temperature can be -20 to -30 °C, the internal temperature can be set to +10 °C. Although this must be increased in spring to avoid condensation in the gas lines.

In very hot climates (e.g. Dubai) where the external temperature can be +40 °C, the internal temperature can be set to +35 °C.

It is very important that the internal temperature be set above the maximum ambient dew point. Eg if the maximum dew point is 30 degrees then the internal operating temperature should be set to 35 to 40 °C to avoid water condensing in the sample lines.

In climates which experience very cold winters and very hot summers, the AQM 65 can be operated in “summer mode temperature”, eg +35 °C and “winter mode temperature”, eg +10 °C The internal temperature should be changed as few times as possible

### IMPORTANT!

- ▲ Changing the internal temperature has a significant effect on the response of the sensor modules. So each time the temperature is changed the AQM 65 needs to have a full gas calibration performed.
- ▲ Contact Aeroqual technical support [technical@aeroqual.com](mailto:technical@aeroqual.com) before making changes to the internal temperature set point.

#### 4.4.12.2 Loss of thermal control

### IMPORTANT!

⚠ A loss of thermal control will affect the accuracy of the sensor module readings and could lead to damage of the internal components.

The internal temperature is recorded as ITemp and can be checked using the charts tool in the Manage Data app. Figure 4-28 shows an example of loss of thermal control.

There is a detailed description of the thermal management system in the online training, which can assist in troubleshooting problems with the thermal management system.



Online  
reference

[training.aeroqual.com](http://training.aeroqual.com) AQM 65 Technical Training Section 3.3

If you observe a loss of thermal management as shown in Figure 4-28 contact Aeroqual technical support for advice [technical@aeroqual.com](mailto:technical@aeroqual.com).

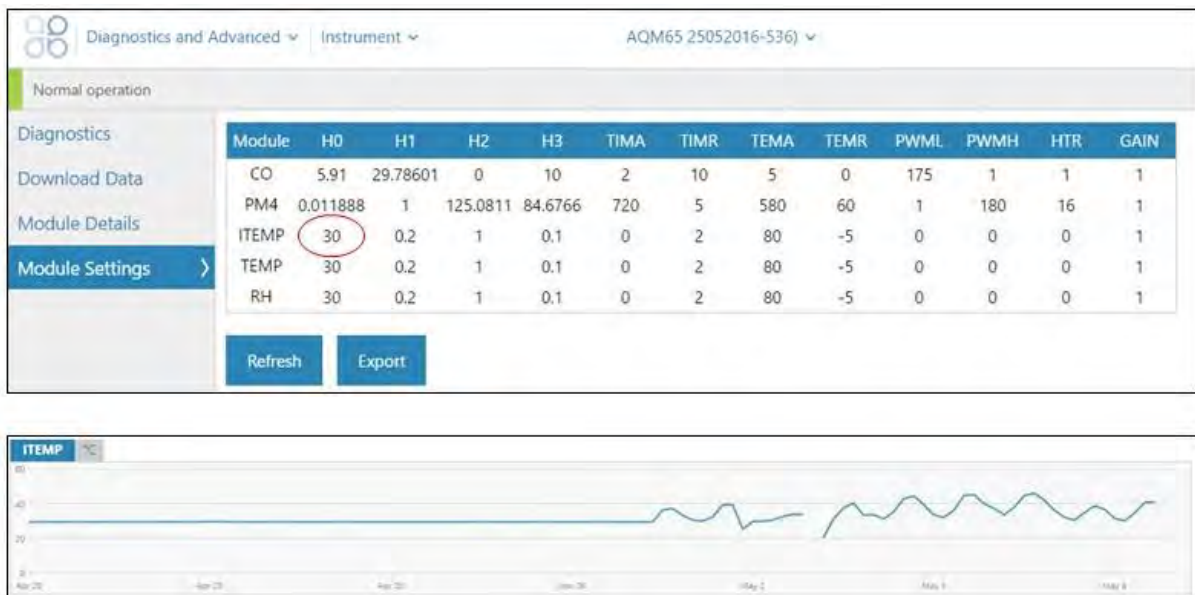

Figure 4-28 The internal temperature set point is set using the H0 parameter in the ITemp module settings. Loss of thermal management can be seen in the charts section of the manage data app.



#### 4.4.12.3 Clean TMS cassette and condenser fins

Dirt and other debris can accumulate in the compressor cassette and can affect air flow through the cassette and lead to overheating of the compressor. Keeping the compressor clean is an important part of thermal management system maintenance.

AQM 65s which are installed in environments with high amounts of airborne dirt and dust will require more frequent cleaning.

Figure 4-29 shows how dust and debris can accumulate within the TMS cassette

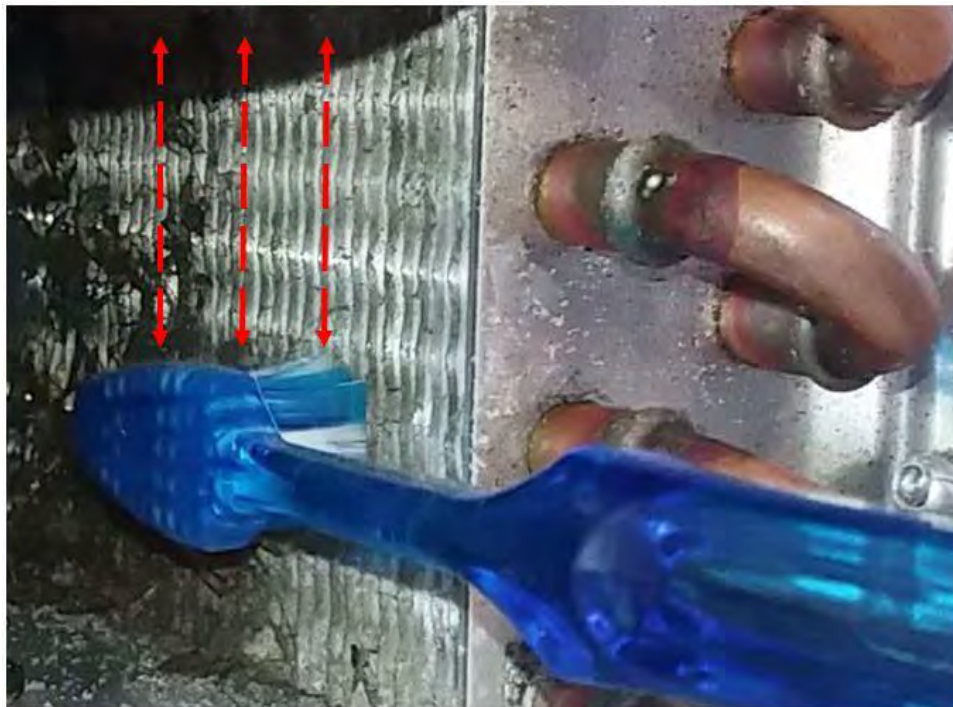

**Figure 4-29** Dirt and debris can accumulate within the TMS cassette leading to reduced efficiency of the thermal management system.

Use a damp cloth to wipe the compressor tank and copper lines.

Use a small long handled brush to gently clean the condenser fins from top to bottom in short downward strokes parallel to the fins.

Do not brush against the fins as this can cause the fins to bend out of shape.



**Figure 4-30** Clean the condenser fins by brushing up and down parallel to the direction of the fins

Inspect the fan at the outside back of the cassette.  
If the fan is dirty take the corner nuts off and carefully remove the fan.  
Make a note of the position and orientation of the fan when you remove it.

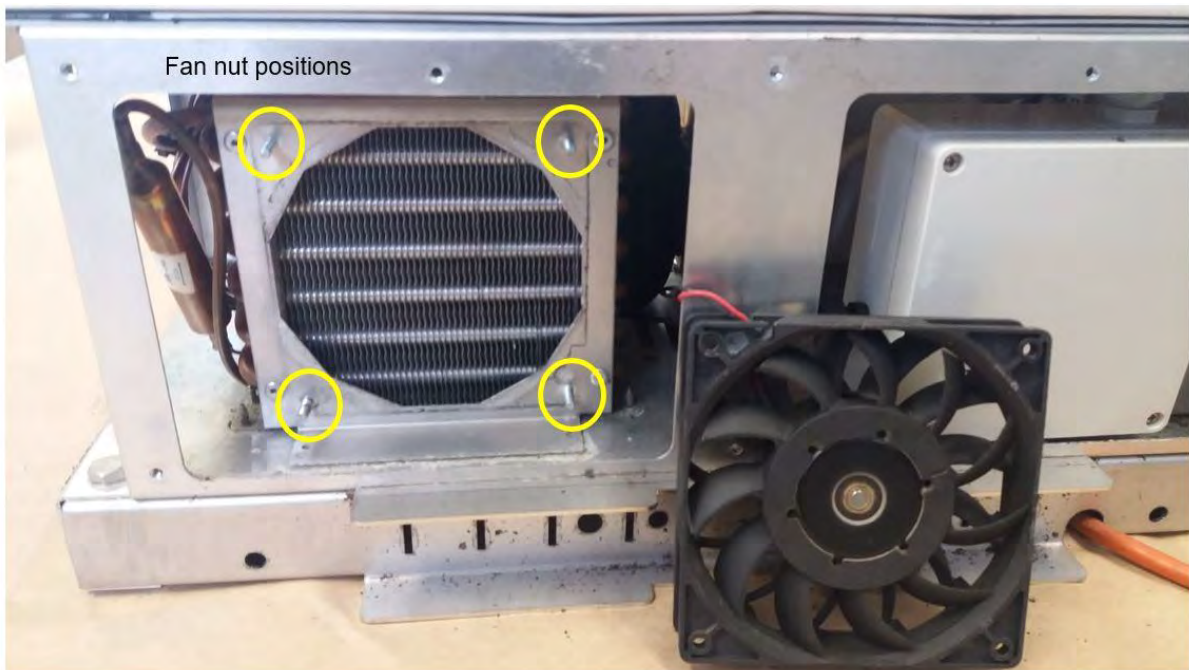

**Figure 4-31** The cooling can be removed for cleaning. Make a note of the orientation of the fan and replace back the fan in the same position

Carefully clean the blades of the fan with a damp cloth  
Replace the fan back in the same position.



#### 4.4.12.4 Check TMS compressor gas pressure and re-fill

The coolant in the TMS compressor gas is R134a (1,1,1,2-Tetrafluoroethane). This is a common refrigerant gas. The gas must be purchased locally because Aeroqual cannot ship gas.

Aeroqual can provide the pressure gauge to measure the compressor pressure, see Figure 4-32.

#### IMPORTANT!

- ▲ The compressor requires that gas be added to a specific PRESSUE, not a specific weight, so it is very important to use the pressure gauge provided by Aeroqual when re-filling the compressor with gas.



Figure 4-32 The pressure gauge provided by Aeroqual for refilling the compressor with gas

You will also need a valve to add to the can or cylinder of gas.

Aeroqual can provide a charging hose (AQM R12) to connect the valve to the pressure gauge.



Can of 134a coolant

Valve for can

R12 charging hose

Figure 4-33 Parts required for refilling the TMS compressor with coolant gas. The gas and valve must be purchased locally

**NOTE:** The TMS compressor will require between 8 and 10 grams of gas for a full refill

Make sure the AQM 65 has been running for at least 1 hour with the door closed before attempting to refill the compressor.

Open the door to the AQM 65 and leave the door open during this process. Find the internal temperature sensor which is plugged into the side wall of the TMS module. Unplug the temperature sensor and replace it with the plug shown in Figure 4-34. Leave this plugged in during this process.

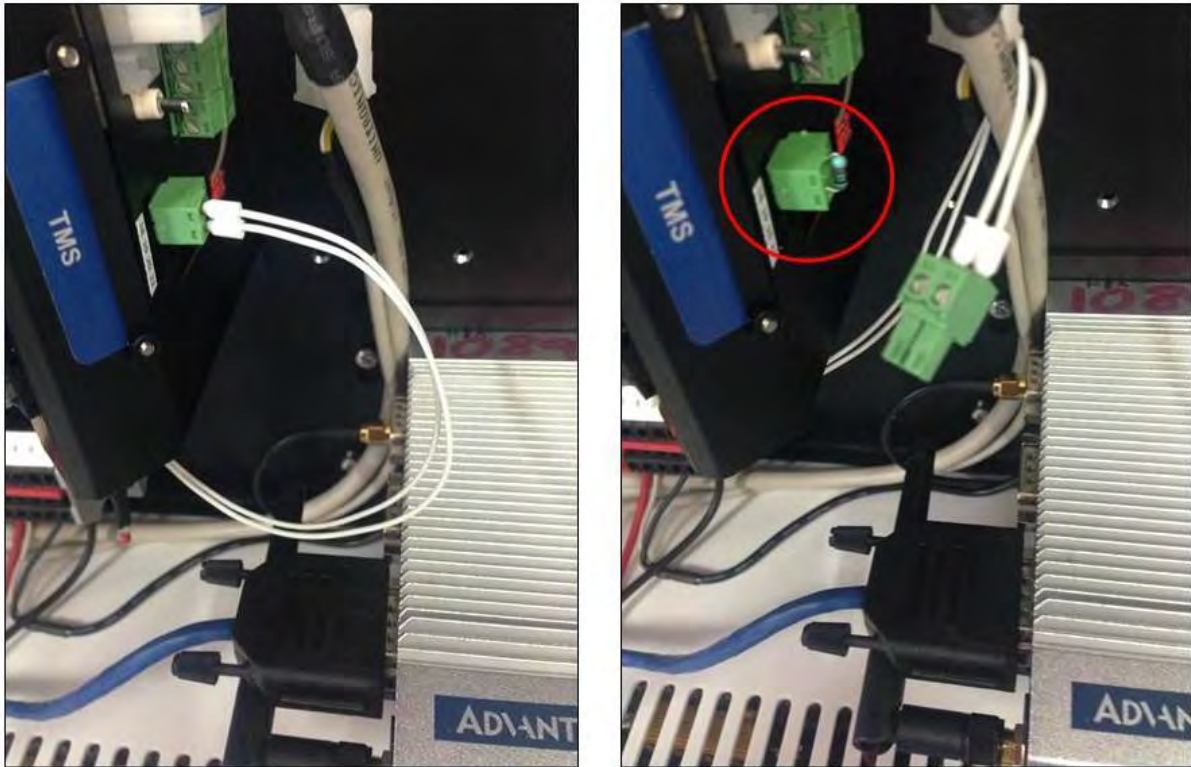

**Figure 4-34** Replace the internal temperature sensor with the temporary plug shown

Unscrew the protection cap, and leave in a safe place because you will need to replace it at the end.

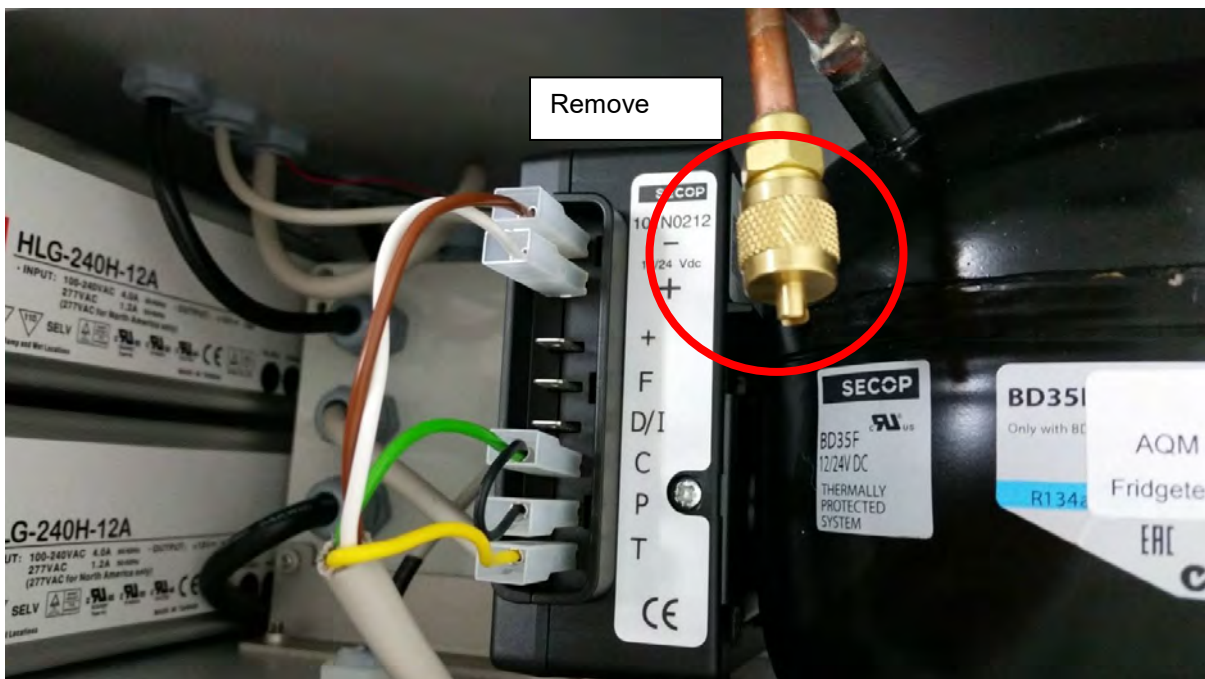

**Figure 4-35** Remove the protective cap from the gas inlet

Remove the charging cap from the end of the pressure gauge and screw it on to the end of the compressor inlet



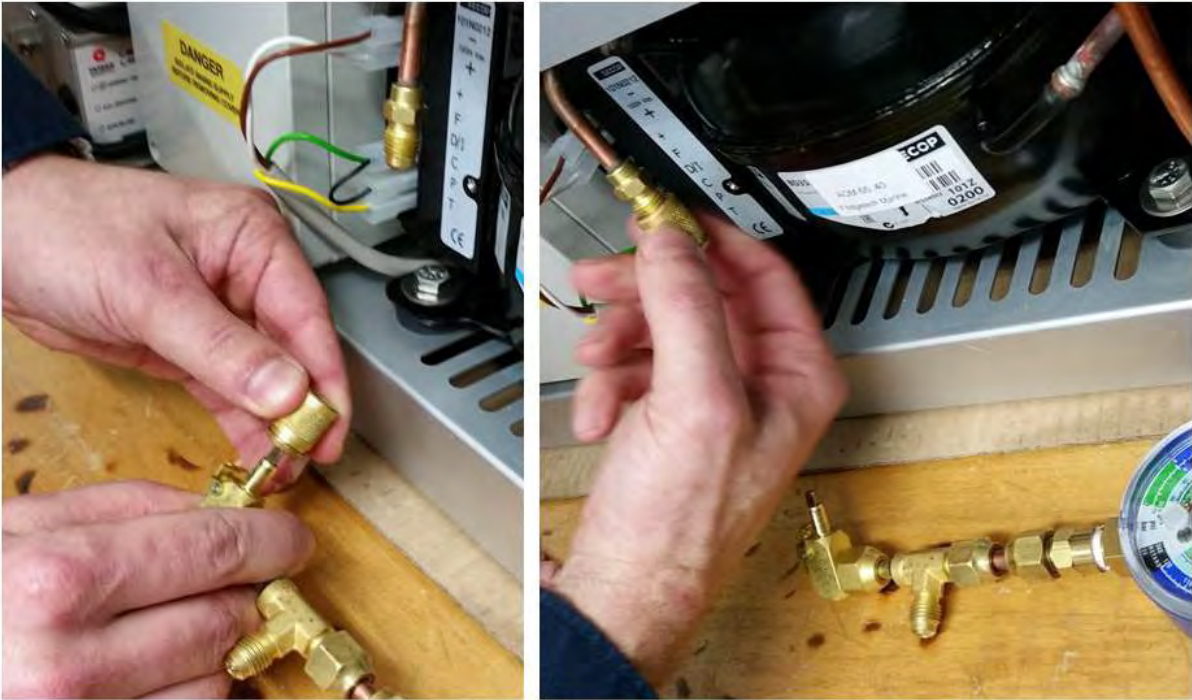

**Figure 4-36 Attach the charging cap from the pressure gauge and screw it on to the gas inlet on the compressor**

Attach the pressure gauge as shown below. It should PUSH in. See the short video:



**Figure 4-37 The pressure gauge pushes in to the fitting on the compressor inlet**

The gauge will respond **SLOWLY**. You should wait **5 minutes** for the gauge to stabilise before continuing with the next step.

Attach one end of the hose to the pressure gauge and the other to the can or cylinder of R134a **DO NOT** open the valve on the cylinder yet.





**Figure 4-38** Hose attached to the pressure gauge and to the cylinder of R134a

The objective is to pressurise the compressor to a predefined pressure. Your target pressure is dependent upon the current temperature of the room or environment where you are performing this exercise.

So you should know the current ambient temperature where you are and then read off the table what your target pressure in PSI is.

Ambient Temperature	Minimum Pressure set-point	Target Pressure set-point	Maximum Pressure set-point
15 – 17.9 °C	6 psi	7 psi	8 psi
18 – 19.9 °C	8 psi	9 psi	10 psi
20 – 22.9 °C	10 psi	11 psi	12 psi
23 – 24.9 °C	12 psi	13 psi	14 psi
25 – 27.9 °C	13 psi	14 psi	15 psi
28 – 29.9 °C	15 psi	16 psi	17 psi
30 – 32.9 °C	16 psi	17 psi	18 psi
33 – 34.9 °C	17 psi	18 psi	19 psi

**IMPORTANT!**

- ⚠ The pressure variation is only a few PSI. It is important to try to achieve the target pressure point.
- ⚠ The risk of UNDER pressurising is that the AQM 65 will not be able to control the internal temperature in hot outdoor conditions.
- ⚠ The risk of OVER pressurising is that during the cooling cycle the AQM will cool too rapidly leading to an overshoot of the target temperature which will result in unstable sensor readings. YOU SHOULD NOT OVER FILL, it is important to reach the target pressure.

Make sure that you read the gauge correctly. The PSI scale is the inside blue scale (the outside scale is bar) See Figure 4-39



**Figure 4-39 The PSI scale in the inside of the dark blue circle**

The process for pressurising the compressor is as follows:

- Gently open the valve of your cylinder or can and watch the pressure gauge increase until just over your desired set point.
- Turn off the cylinder or can valve and wait 3 to 5 minutes and watch the gauge. The gauge might slowly come down again as the gas pressure equilibrates in the cooling system.
- If the needle drops below your target pressure then repeat again, each time only let in a small amount of gas and WAIT for the gauge needle to stabilise. Stabilisation may take several minutes (5 minutes).

If you overfill by mistake you can release pressure from the valve on the tee. Unscrew the connection to the R12 valve.

1. Use a pen or similar to press in the valve pin. Do this for a short time 2 seconds only. Watch the needle on the gauge. Wait (2 to 3 minutes) for the pressure to stabilise.
2. Repeat the process until the pressure reaches the target level.



**Figure 4-40 Gently release pressure from the gas line by pressing the release valve on the gauge**

Gently detach the valve connection. You will lose a very small amount of gas during this process. Remember to replace the protection cap after you remove the valve.



**Figure 4-41 Replace the protection cap once you have finished the process**



## 4.5 Factory calibration of Particle Monitor and Particle Profiler

Dust and other debris can settle upon the internal optics of the optical engine which can lead to inaccurate readings. The laser and detector may also need to be replaced.

The Particle Monitor optical module (nephelometer) requires a factory service and calibration every two years.

The Particle Profiler optical module (optical particle counter) requires a factory service and calibration every year.

Contact [technical@aeroqual.com](mailto:technical@aeroqual.com) for information about factory service and calibration of the Particle Monitor and Particle Profiler.

## 4.6 Service frequency guidelines

The frequency of some of the service activities described above can depend upon environmental conditions and also upon data quality objectives. Some service activities are required at fixed frequencies (**scheduled maintenance**), and some are performed only as required (**unscheduled maintenance**).

Service intervals will vary depending on site conditions. For instance, particulate matter levels will impact the frequency of filter changes – high PM levels = more frequent filter changes

It is important to change the filter when it gets dirty. Once the local site conditions are understood, a filter change schedule can be developed for that site.

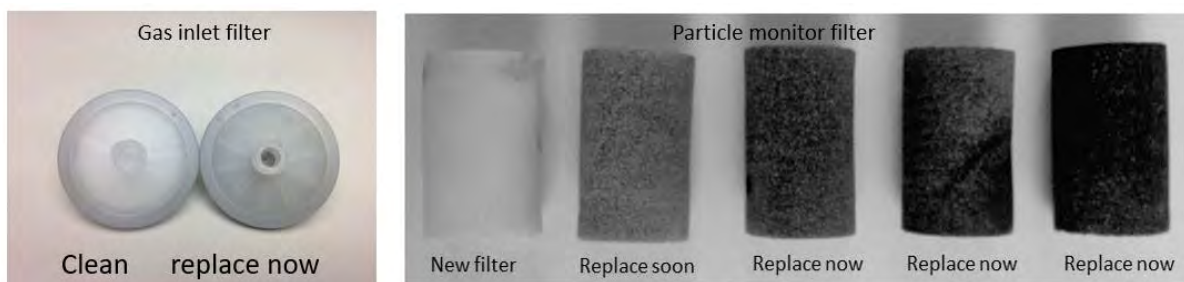

**Figure 4-42 Filters should be changed before they get too dirty. The frequency of filter changes will depend upon local site conditions.**

Data quality objectives will also influence the service frequencies for some operations. In monitoring situations where data quality objectives are high, for example where monitoring is performed for compliance or where a high amount of scrutiny will be placed on the data, service frequencies may be higher.

It is recommended that the instrument engineer, over time, develops an appropriate servicing schedule for a particular site.

Table 4.1 provides guidelines for service frequencies for the service activities documented in this user guide.



<b>Scheduled maintenance</b>		
<b>Service activity</b>	<b>Section reference</b>	<b>Service frequencies</b>
Gas inlet filter change	Section 4.4.2	4-12 weeks <b>Initially 4 weeks</b> . Later this can be modified to suit local conditions and data quality objectives
PM inlet filter change	Section 4.4.4	4-12 weeks <b>Initially 4 weeks</b> . Later this can be modified to suit local conditions and data quality objectives
Gas inlet flow check	Section 4.4.3	4-12 weeks <b>Initially 4 weeks</b> . Later this can be modified to suit local conditions and data quality objectives
PM inlet flow check	Section 4.4.5	4-12 weeks <b>Initially 4 weeks</b> . Later this can be modified to suit local conditions and data quality objectives
Gas inlet flow adjustment	Section 4.4.3.3	Adjust as required following gas inlet flow check
PM inlet flow adjustment	Section 4.4.5.2	Adjust as required following PM inlet flow check
Clean TMS cassette	Section 4.4.12.3	The TMS cassette should be checked and cleaned when required (every <b>3 to 6 months</b> typical)
PM leak check	Section 4.4.6	Every <b>3 months</b> (Quarterly)
PM zero calibration check	Section 4.4.7.1	Every <b>3 months</b> (Quarterly)
PM zero calibration flow check	Section 4.4.7.2	Every <b>3 months</b> (Quarterly)
PM inlet cleaning	Section 4.4.8	Every <b>3 months</b> (Quarterly)
Change gas flow pump	Section 4.4.9	Every <b>12 to 18 months</b> or if flow rate cannot be set correctly
Change Particle Monitor flow pumps	Section 4.4.9	Every <b>12 to 18 months</b> or if flow rate cannot be set correctly
Factory calibration of Particle Monitor	Section 4.5	Every <b>24 months</b> (2 years)
Factory calibration of Particle Profiler	Section 4.5	Every <b>12 months</b> (1 year)
Gas module calibration	Section 5.1	See section 5.1
<b>Unscheduled maintenance</b>		
Measure flow rate of gas modules	Section 4.4.3.2	As required following gas inlet flow check
Leak check a gas module	Section 4.4.10	As required following module flow check
Recharge compressor with gas	Section 4.4.12.4	As required or when directed by Aeroqual technical support
Add, remove, replace gas module	Section 4.4.11	As required

The service frequencies should be considered conservative. Instrument operators are encouraged to develop a service schedule suitable for their local conditions and data quality objectives. Table 4-2 Service frequency guidelines for various service activities

## 5 Gas module calibration

Calibration is an activity that requires attention to detail and accuracy. You should read this entire calibration section and understand it before starting, even if you are an experienced practitioner.

The AQM 65 is calibrated using a two-point calibration procedure, first by delivering zero air to the AQM 65 inlet and adjusting the offset, and then delivering span gas to the AQM 65 inlet and adjusting the gain. Occasionally a multipoint calibration may be required.

Aeroqual provides all of the equipment required to perform the calibration. Aeroqual offers a portable calibrator called the AirCal 1000 shown in Figure 5-3 and an integrated calibrator shown in Figure 5-5.

Aeroqual cannot supply calibration gas; this must be acquired locally. Recommended gas cylinder sizes and concentrations are given in Table 5-1

Offset and gain adjustments are performed using the software tools provided by Aeroqual Connect or Aeroqual Cloud.

If the AirCal 1000 is being used, there is a separate PC desktop software application to control it which can be downloaded from the website.



### Some important considerations for calibration:

- Gas module calibration is achieved using certified calibration gas and a gas dilution calibrator.
- For ozone, an ozone generator, (ozone calibrator) must be used, Aeroqual recommends the 2B Tech Ozone generator part number AQM O3CAL.
- When calibrating CO<sub>2</sub>, gas is delivered directly to the AQM inlet without the use of a calibrator, (Appendix 4).
- Aeroqual does not recommend calibration when first commissioning a new AQM 65. We recommend first calibrating 1-3 months after commissioning.
- The quality of the calibration gas makes a big difference to success of a calibration, only purchase calibration gas from a reputable calibration gas supplier.
- The AQM 65 must be in a stable condition before calibration can be attempted. The AQM 65 must have been running for at least 6 hours before calibration, ideally 24 hours.
- The **zero** calibration step takes approximately 30 to 40 mins **total across all modules**. The span calibration takes approximately 30 to 40 minutes **per-module**. Therefore an AQM 65 with **5 gas modules** will take 40 + (5 \*30) minutes (**approximately 3 hours**) to calibrate.
- Record keeping is a crucial part of calibration, Appendix 7 is a calibration record template which you should use to keep a record of your calibration. The journal feature in Connect and Cloud can also be used to keep records of calibration activities.

Calibration is discussed in detail in the online training, there are several supporting videos also

In May 2018, Aeroqual made improvements to way we measure NO<sub>2</sub>, instruments delivered before May 2018 will have a direct NO<sub>2</sub> measurement module, instruments delivered after May 2018 will have a Ox/O<sub>3</sub> measurement system. See section 5.7.3.1 for details.

available.

	Online reference	<a href="http://training.aeroqual.com">training.aeroqual.com</a> AQM 65 Technical Training Section 5
	Online video	You Tube Channel: Aeroqual Calibration playlist

## 5.1 Calibration frequency

Calibration is an activity that requires attention to detail and accuracy. Calibration frequency is a balance between the costs of service and data quality objectives.

For some monitoring applications such as compliance monitoring the calibration frequency may be regulated, for other monitoring applications it is a choice.

The optimum frequency will depend on the importance of the dataset, the service budget and the stability of the instrument under the prevailing conditions.

At the high cost end of the spectrum are national ambient monitoring networks and the USEPA Quality Assurance Handbook (see <http://www.epa.gov/ttnamti1/qalist.html>) is a good example of how prescriptive calibration requirements for such applications can be.

Aeroqual makes the following recommendations about calibration frequency for the AQM 65.

- Follow all local regulatory calibration requirements if these are defined for the AQM 65 monitoring purpose.
- Plan routine calibrations at an interval that is consistent with the data quality objectives for your monitoring purpose.

Before gas calibration is considered it is important to first confirm all instrument operational parameters such as flow rates, filter cleanliness, internal temperature control, have been confirmed to be correct and optimal.

In the absence of a prescribed calibration schedule, which may be given if the AQM 65 is used under a compliance monitoring framework, the decision to calibrate should be made following a careful analysis of the data.

If the data quality falls outside of what is required for the monitoring application, or the range of measurements are significantly different than what is expected at the monitoring site then a gas calibration can be considered.

AQM 65 users typically calibrate every 3 to 12 months. The specific calibration interval for any given instrument varies within this range, and is determined by the considerations discussed here.

## 5.2 Guidelines for purchasing calibration gas cylinders and gas regulators

The AQM 65 is calibrated using certified calibration gas cylinders from a reputable gas supplier. Calibration gas is purchased at high concentrations, in a balance of air or nitrogen and then diluted to a lower concentration using a gas dilution calibrator such as the Aeroqual AirCal 1000 or Aeroqual AirCal 8000 gas dilution systems. Other gas dilution systems can also be used.

- Span calibration gas must be delivered to the AQM 65 in a balance of Air.
- Gas cylinders can purchased in a balance of Air or Nitrogen (N<sub>2</sub>). Calibration gas will be diluted with air (at least 50 x) using a gas dilution calibrator so the final span gas mixture will always be in a balance of air.
- Aeroqual does not recommend calibrating from a cylinder of mixed gases. Only single gases should be used to calibrate the AQM 65.
- Calibration directly from a gas cylinder without dilution is not recommended.
- Ozone is calibrated using an ozone calibrator (Ozone cannot be purchased in a cylinder).
- CO<sub>2</sub> is calibrated by direct injection of zero air from a cylinder and then CO<sub>2</sub> from a cylinder (via a tee) to the AQM 65 inlet, See Appendix 4 for details on CO<sub>2</sub> calibration.

### 5.2.1 Purchasing calibration gas: recommended cylinder concentrations and sizes.

Calibration gas should be purchased from a reputable calibration gas supplier, there are several such suppliers worldwide. Aeroqual recommends Calgaz, ([www.calgaz.com](http://www.calgaz.com)) for portability. A list of Calgaz part numbers for calibration gas cylinders which Aeroqual recommends is given in Table 5-1.

The Calgaz cylinders have a C10 (5/8 – 18 UNF) thread (C10 fitting) which easily fits the Aeroqual two stage pressure gas regulator (Aeroqual part number **AIC GASREG01**), also shown in Figure 5-2

Note that two different cylinder types are specified; the 8AL cylinder is an aluminium cylinder which holds 58 litres of gas, the physical size of this cylinder is shown in Figure 5-1. The 6D cylinder is a steel cylinder which holds 103 litres of gas, it is the same physical size as the 8AL cylinder.

A single gas module calibration will use 1 to 2 litres per calibration if using the Aeroqual calibration systems. This means that approximately 40 calibrations can be achieved with the 8AL cylinder and 70 calibration can be achieved with the 6D cylinder.



AQM 65 gas module	O3	NO2	NOx	CO	SO2	VOC	H2S	CO2
Gas used for calibration	O3	NO2	NO2 or NO	CO	SO2	Isobutylene C <sub>4</sub> H <sub>8</sub>	H2S	CO2
Gas module measurement range	0 to 0.5 ppm	0 to 0.2 ppm	0 to 0.5 ppm	0 to 25 ppm	0 to 10.0 ppm	0 to 20 ppm	0 to 10 ppm	0 to 2000 ppm (0.2 %)
Span gas concentration for calibration	0.1 ppm	0.1 ppm	0.1 ppm	10.0 ppm	0.5 ppm	10.0 ppm	0.5 ppm	1000 ppm
Recommended Minimum, Maximum	<b>0.08 - 0.150</b>	<b>0.05 - 0.150</b>	<b>0.05 - 0.2</b>	<b>5 - 15</b>	<b>0.2 - 1.5</b>	<b>5 - 15</b>	<b>0.2 - 1.5</b>	
Recommended cylinder concentration when using AirCal 1000 or AirCal 8000	Ozone is delivered by an Ozone generator	<b>20 ppm</b>	<b>20 ppm</b>	<b>1000 ppm</b>	<b>20 ppm</b>	<b>1000 ppm</b>	<b>20 ppm</b>	<b>1000 ppm</b>
Recommended (ppm) Minimum, Maximum		<b>10 - 100</b>	<b>10 - 100</b>	<b>500 - 5000</b>	<b>10 - 100</b>	<b>500 - 5000</b>	<b>10 - 100</b>	<b>500 - 1500</b>
Recommended Gas cylinder from <a href="http://www.calgaz.com">www.calgaz.com</a>	N/A	20 ppm NO2 Balance AIR 8AL 58 liters C10 fitting	20 ppm NO2 Balance AIR 8AL 58 liters C10 fitting	1000 ppm CO Balance N2 6D 103 liters C10 fitting	20 ppm SO2 Balance N2 8AL 58 litres C10 fitting	Isobutylene 1000 ppm Balance Air 6D 103 litres	20 ppm H2S Balance N2 8AL 58 litres C10 fitting	1000 ppm CO2 Balance Air 6D 103 litres C10 fitting
Part number:		A0446046	A0446046	A0436734	A0446071	A0436843	A0446004	A0189932

**Table 5-1 Recommended calibration cylinder concentrations. The recommended concentration is written in bold, the minimum and maximum recommend concentration are written in green in the table.**



**Note: The AQM 65 must be zero calibrated using zero air, N2 can not be used for zero calibration.**

## 5.2.2 Cylinder of certified zero air and certified CO2 for CO2 calibration

CO2 cannot be calibrated using the Aeroqual calibration systems, a cylinder of certified zero air, Calgaz part number **A0194363** should be used to zero calibrate the CO2 module. And a cylinder of 1000 ppm CO2 part number **A0189932** used to span calibrate the CO2 module. See Appendix 4 for detail on CO2 calibration.

## 5.2.3 Considerations for gas cylinder size

Any gas cylinder size can be used with the Aeroqual AirCal systems, Figure 5-1 shows a range of cylinder sizes which can be used successfully with the AirCal 1000. Any of the cylinders in Figure 5-1 can also be used successfully with the AirCal 8000, however the AirCal 8000 cylinder enclosure is designed to hold the 6D and 8AL cylinders from Calgaz,, Figure 5-5, therefore larger cylinders will need to be secured and protected if they are to be used with the AirCal 8000.

	Online reference	<a href="http://training.aeroqual.com">training.aeroqual.com</a> AQM 65 Technical Training Section 5
	Online video	You Tube Channel: Aeroqual Calibration playlist

Larger cylinders will be difficult to transport; small gas cylinders are easier to store and transport.



**Figure 5-1** The left side image shows a large and medium laboratory gas cylinder. Both can be used with the AirCal 1000 or AirCal 8000. On the right hand side are small size cylinders from Linde and Calgaz. These are more convenient and easy to transport.



**Figure 5-2** See the Aeroqual online training on connecting your gas regulator to your cylinder, Aeroqual YouTube channel.

## 5.3 Calibration safety

### IMPORTANT!

⚠ There are two main safety considerations when handling calibration equipment. Gas calibration equipment should always be handled in accordance with local laws and regulations. Always make sure you have the Material Safety Data Sheet for the gases you are using and you are aware of the first aid procedures required should these become necessary.

#### ⚠ Compressed gas safety considerations

Calibration gas cylinders are at high pressures, often over 1000 PSI. This represents significant risk if any of the pressure connections are not secure.

- Always use high quality gas compression fittings on the pressure side of the gas delivery
- Always make sure the exit pressure of the regulator does not exceed the maximum pressure of the gas lines you are using
- Always use appropriate safety equipment such as safety glasses when handling calibration equipment.

#### ⚠ Gas toxicity consideration

Some of the gases used during calibration may represent a toxicity risk and all gases represent an asphyxiation risk.

⚠ Always make sure the exhaust gas is well ventilated away from people

## 5.4 Aeroqual portable calibration systems: AirCal 1000, and AQM O3CAL.

The AirCal 1000 is a stand-alone portable calibrator which is transported to the AQM 65 along with gas cylinders and set up on site and then removed from site following the calibration.

The AQM O3CAL is a portable Ozone calibrator which can easily be carried to an AQM 65 for Ozone calibration.

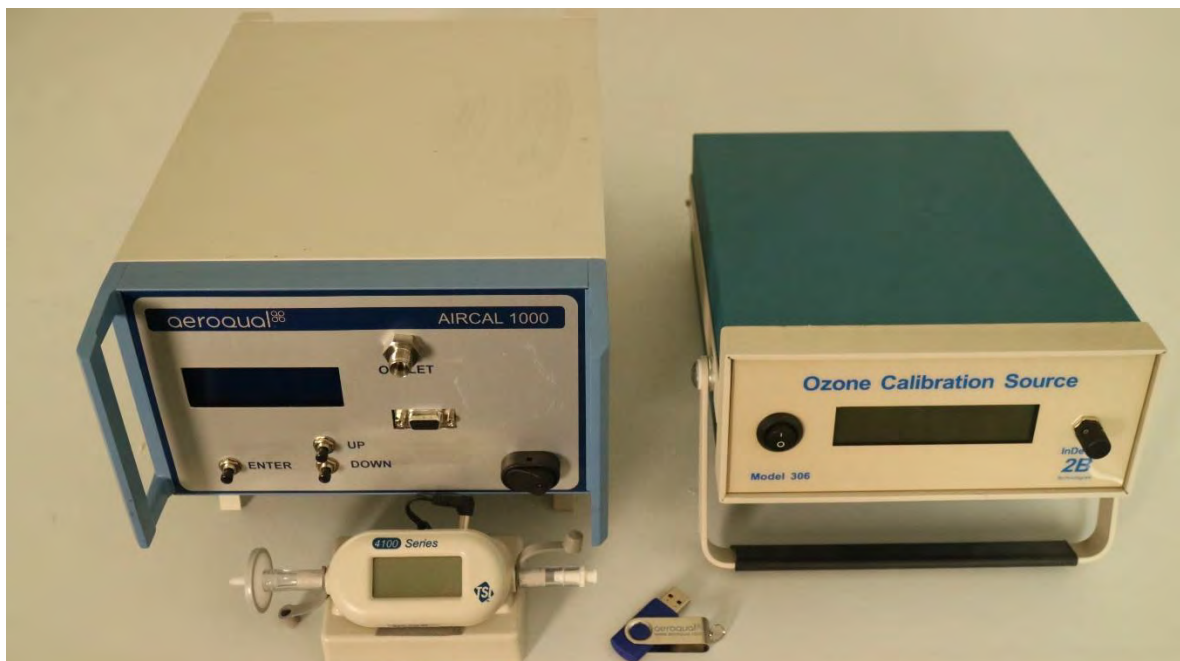

Figure 5-3 The Ozone calibrator (right) and AirCal 1000 (left) are light weight and can easily be transported to the AQM 65



- The outlet flow rate of the AirCal 1000 is fixed at approximately 2.5 LPM which means that it can be used to calibrate more than one AQM 65 simultaneously as shown in Figure 5-4.
- On the AirCal 1000 there are two gas inlet ports (1/8 Swagelok compression) and one gas outlet port (1/4 Swagelok compression).
- Aeroqual specified gas regulator (AIC GASREG01) are recommended for use with the AirCal 1000. These are optional, and can be shipped along with the AirCal.
- The AirCal 1000 has an internal integrated zero air generator for zero calibration.
- The AirCal 1000 cannot be used to zero or span calibrate CO<sub>2</sub>. See Appendix 4.
- The AirCal 1000 can be used to zero calibrate Ozone, but not for Ozone span calibration. For Ozone span calibration Aeroqual recommends the 2B Technologies Model 306 Ozone (AQM O3CAL) generator shown in Figure 5-3 .
- The AirCal 1000 and AQM O3Cal are not IP rated, so care must be taken when operating outdoors.



**Figure 5-4 The Ozone calibrator and AirCal 1000 can calibrate multiple instruments at the same time.**

## 5.5 Aeroqual integrated calibration system AirCal 8000

The AirCal 8000 is an integrated calibration system whereby the gas cylinders and calibration system are installed inside the AQM 65 and permanently left in place. The AirCal 8000 can be scheduled to deliver calibration gas automatically or can be manually triggered remotely using Aeroqual Cloud without the need for a calibration engineer to visit the AQM 65.

Figure 5-5 left shows two gas cylinders (Calgaz) in the cylinder housing on the outside gas enclosure of the AQM 65. Figure 5-5 right, shows the calibration module which sits inside the AQM 65 enclosure.

AirCal 8000 comes with two Aeroqual regulators (**AIC GASREG01**) and all of the tubing and fittings required.

The AirCal8000 does not include calibration gases, these must be purchased locally.

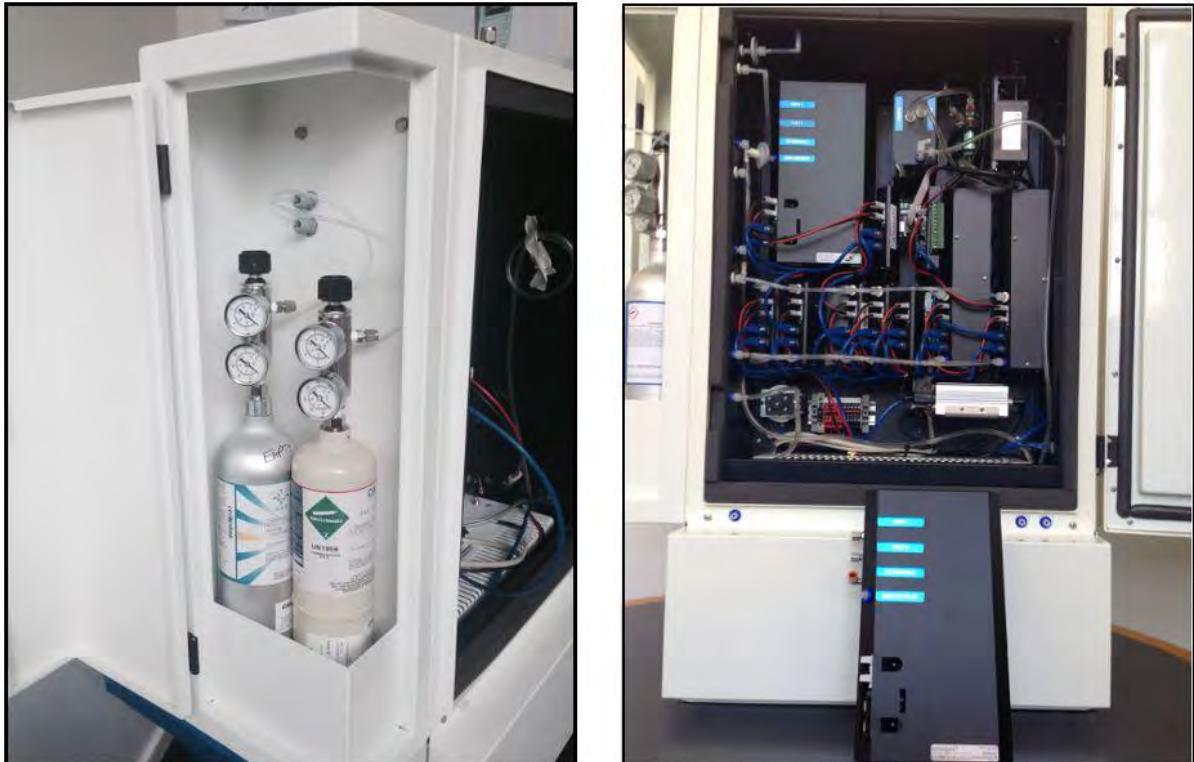

**Figure 5-5** The AirCal 8000 stores calibration cylinders in a compartment on the left side. All of the components required to perform the calibration are in a module inside the AQM 65.



## 5.6 Calibration accessories: tubing, fittings, gas regulator.

The AQM 65 calibration systems; AirCal 1000 and AirCal 8000, use imperial size tubing and Swagelok compression fittings; Stainless steel ¼ and 1/8.

The AirCal 1000 and AirCal 8000 systems are shipped with all of the tubing and fittings required to calibrate the AQM 65.

- All of the tubing and fittings used to calibrate the AQM 65 need to be inert fluoropolymer tubing such as PTFE, PVDF, FEP, or FFA. Stainless steel fittings can also be used, stainless steel tubing is not recommended.
- The outlet fitting on the Aeroqual two stage gas regulator (**AIC GASREG01**) is a 1/8 Swagelok compression fitting, shown in Figure 5-7.
- The gas inlet fitting on the Aeroqual AirCal 1000 and 8000 are also a 1/8 Swagelok compression fitting. The maximum inlet pressure is 50 PSI.
- The AQM 65 gas inlet fitting is a ¼ Swagelok compression fitting shown in Figure 5-6 The Aeroqual AQM 65 CALKIT, shown in Figure 5-6 is used to connect the outlet of the AirCal 1000 and Ozone generator to the inlet of the AQM 65.

### 5.6.1 Inert fluoropolymer tubing for module calibration

- The tubing which connects the outlet of the calibrator to the inlet of the AQM 65 (via a tee), is ¼ OD PTFE tubing. Additional tubing can be ordered from Aeroqual in meter quantities: part number **AS R66**. The tubing is shown in Figure 5-7
- The tubing which connects the Aeroqual two stage gas regulator (**AIC GASREG01**) to the inlet of the Aeroqual AirCal 1000 and 8000 calibration systems is 1/8 OD PTFE. Additional tubing can be ordered from Aeroqual in meter quantities: part number **CS TUBE27**. These are shown in Figure 5-7.



Figure 5-6 The AQM CALKIT connects the output of the AirCal 1000 to the input of the AQM 65 via a tee.

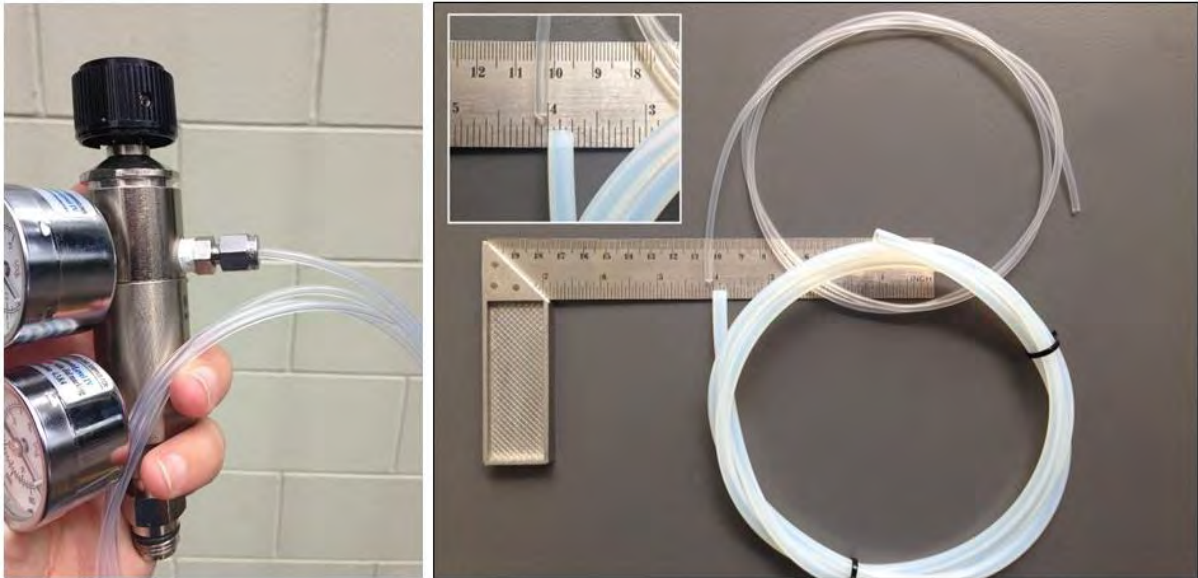

**Figure 5-7** The Aeroqual gas regulator is fitted with a 1/8 inch Swagelok compression fitting. Additional tubing for calibration can be purchased from Aeroqual: 1/8 OD tube Aeroqual part number CS Tube 27 and 1/4 OD Tube Aeroqual part number AS R66.

## 5.7 Calibration procedure

The calibration procedure involves delivering a source of calibration gas to the AQM 65, waiting for the instrument to stabilise towards the calibration gas and then making a decision about whether instrument adjustments should be made or not made.

### 5.7.1 Site inspection and instruments pre-checks

When arriving back to the monitoring site after some time it is important to be sure that no new local emission sources or obstructions have appeared since the last visit.

- Inspect the local surroundings, and check for local point source emissions such as open fires, exhaust emissions from a newly positioned generator for example.
- Also check for new obstructions which affect the measurements, such as a newly constructed fence for example.
- Record anything noteworthy about the surroundings in the journal.
- Inspect the instrument, especially the gas inlet, particle inlet and door handles to make sure nothing has been tampered with.
- Record anything noteworthy about the instrument in the journal.

### 5.7.2 Using the AQM 65 Journal and the calibration template to log calibration details

- The AQM 65 journal will automatically record any changes to the offset or gain that is applied.
- You must log in the journal when you applied the zero air as this is not automatically recorded unless you are using the AirCal 8000.
- It is recommend to record details about the cylinder concentrations in the journal.
- Record which span points you are using and when you started the span gas flowing.
- You can also use the calibration template in Appendix 7 to record the results of the calibration

### 5.7.3 Overall calibration workflow:

1. Ensuring the AQM is fit for calibration involves checking key operating parameters such as flow rates and operating temperature and changing the gas inlet filter.
2. Setting up the calibration equipment.
3. Performing a zero calibration on all gas sensors at the same time.
4. Then performing a span calibration module by module. (If you have the Ox/O<sub>3</sub> system make sure you follow the order correctly)
5. Documenting all stages of the process in the instrument journal.
6. Final checks before leaving site and scheduling the next calibration.

Data arising from the calibration can be written in the calibration form template: Appendix 7

Note: The AQM 65 must be zero calibrated using zero air, and span calibrated in a balance of air, N<sub>2</sub> can not be used for calibration.

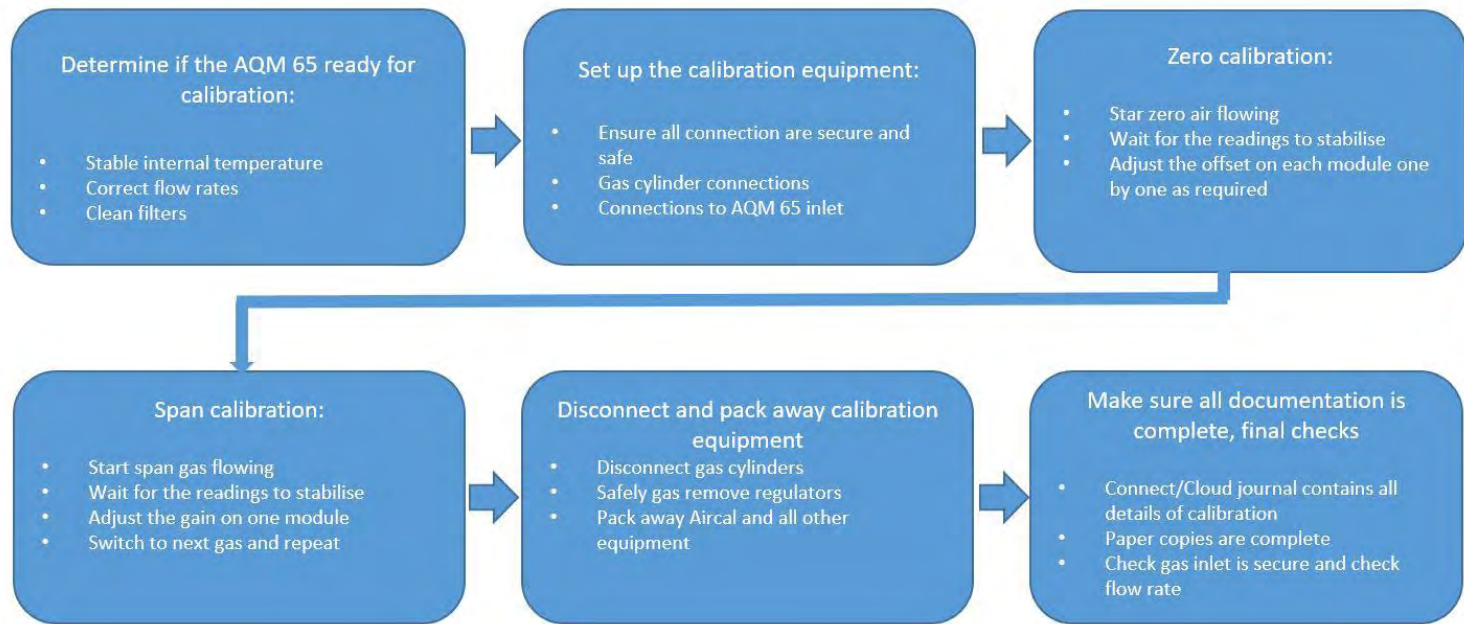

Figure 5-8 Flow schematic for calibration



### 5.7.3.1 New NO<sub>2</sub> calibration procedure overview

In May of 2018 Aeroqual made improvements to the way we measure NO<sub>2</sub>. See the video which discusses the detail for calibrating the Ox/O<sub>3</sub> system for measuring NO<sub>2</sub>.

See the video on calibrating the Ox / Ozone system for measuring NO<sub>2</sub>.



Figure 5-9 Calibration of Ox Ozone system for NO<sub>2</sub> YouTube: [ww.youtube.com/watch?v=InK1x7mTTQw](https://www.youtube.com/watch?v=InK1x7mTTQw)

AQM 65s supplied before May 2018 have the large NO<sub>2</sub> direct measurement module, AQM 65s supplied after May 2018 measure NO<sub>2</sub> using an Ox/O<sub>3</sub> combined measurement system with a calculated NO<sub>2</sub> channel.

The differences between these two systems are illustrated in Figure 5-10. The new NO<sub>2</sub> measurement system is comprised of an Ox measurement module and an O<sub>3</sub> measurement module which is shown on the left in Figure 5-10, the original direct NO<sub>2</sub> measurement module is a single large module shown on the right in Figure 5-10.

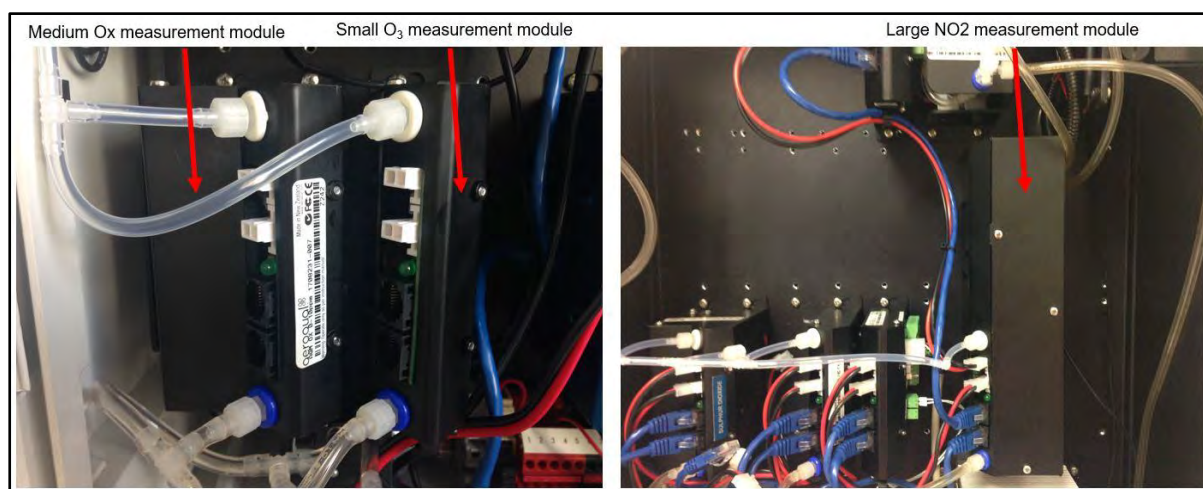

Figure 5-10 Left: An Ox measurement module and Ozone measurement module, (the power and communication cables have been removed for clarity). Right: NO<sub>2</sub> direct measurement module.

The calibration requirements for the new O<sub>x</sub>/O<sub>3</sub> system differ from the original direct measurement module.

The calibration process for the original direct measurement module have not changed.

The original direct measurement module can be replaced in the field with the new O<sub>x</sub>/O<sub>3</sub> system.

**This section provides a summary of how to calibrate the new NO<sub>2</sub> measurement system.**

The new O<sub>x</sub>/O<sub>3</sub> system is determined by the difference between two measurement modules; the O<sub>x</sub> module and the Ozone module.

The O<sub>x</sub> module responds towards both NO<sub>2</sub> and Ozone. The NO<sub>2</sub> concentration is determined by difference according to Equation 1.

$$\text{Equation 1: } [\text{NO}_2] = [\text{O}_x] - a[\text{O}_3]$$

The NO<sub>2</sub> **a** value is set at the Aeroqual factory and adjusts for the relative response of the O<sub>x</sub> module towards ozone calibration gas.

The **a** value should be checked and adjusted as part of routine field calibration, see Figure 3b.

Note that only the **a** value is set for NO<sub>2</sub>, the offset should be left at 0.000 and the gain should be left at 1.000.

Below is a brief summary of the calibration steps for the NO<sub>2</sub>/O<sub>3</sub> system. These steps must be carried out in the order described here.

## Calibration steps for O<sub>x</sub>/O<sub>3</sub> system

It is important to follow the steps in the order described below. Aeroqual recommends calibrating the O<sub>x</sub> and ozone module first, then the remaining modules inside the AQM 65 can be calibrated according to the standard procedure.

### Note:

The O<sub>x</sub> module gain adjustment is made during the NO<sub>2</sub> calibration gas delivery

The NO<sub>2</sub> **a** value adjustment is made during the Ozone gas delivery

The NO<sub>2</sub> gain value is NOT adjusted as part of the calibration process

1. Zero air is delivered to the instrument from the AirCal 1000 (or a suitable zero air source).
2. The zero offset on the O<sub>x</sub> and O<sub>3</sub> module is adjusted so that O<sub>x</sub> and O<sub>3</sub> read zero.  
(Confirm NO<sub>2</sub> reads zero but do not adjust calibration settings offset or gain on the NO<sub>2</sub> channel).
3. Deliver 0.1 ppm NO<sub>2</sub> gas from the calibrator.
4. Adjust **O<sub>x</sub> gain** so the O<sub>x</sub> reads 0.1 ppm. (do NOT adjust NO<sub>2</sub> gain)

The NO<sub>2</sub> module should be reading 0.1 ppm during the 0.1 ppm O<sub>x</sub> span calibration. The NO<sub>2</sub> may read slightly less than 0.1, this is normal, do not adjust the NO<sub>2</sub> gain.

5. Deliver zero air for 10 minutes to allow the sensors to return to baseline.
6. Then deliver 0.1 ppm Ozone.
7. Adjust O<sub>3</sub> gain so that the O<sub>3</sub> module reads 0.1. The O<sub>x</sub> module will be showing a response towards O<sub>3</sub> during the O<sub>3</sub> calibration, this is expected.

If the NO<sub>2</sub> shows a response during the Ozone calibration then a new **a** value must be calculated according to equation 3 and applied as shown in Figure 5-4.

$$\text{Equation 2: } [\text{NO}_2] = [\text{O}_x] - \mathbf{a}[\text{O}_3] = 0.00$$

$$\text{Equation 3: } \mathbf{a} = [\text{O}_x] / [\text{O}_3]_{\text{span concentration}}$$

Set the **a** value in the Manual Entry dialogue in the Service and Calibration App (Section 5.7.5.5), Figure 5-15

Check the NO<sub>2</sub> reads zero under these conditions.

8. Deliver Zero air for 10 mins to purge the gas lines before returning to sampling ambient air.

## 5.7.4 Instrument checks before starting calibration

### Calibration details

Fill in the details in Tables 1, 2, 3, 4 in Appendix 7. It is also a good idea to record this data in the instrument Journal.

**Before you start the calibration check the following and record the results in Table 5 in the Calibration Form in Appendix 7.**

- Put the instrument in to Service Mode, Figure 5-15
- Check that the gas inlet and the particle inlet is secure and the door locks are operational
- Measure the AQM 65 gas inlet flow rate. The expected flow rate should be documented in the journal from the last service visit.
- Record the internal temperature, the expected internal temperature should be documented in the instrument journal from the last visit. See Section 4.4.12.1 for how to look up the expected internal temperature.
- It is important that the AQM 65 be stable at its internal temperature set point. Connect to the instrument and check the internal temperature has been stable at the correct temperature. If the internal temperature is not correct you must address this before attempting a calibration. See Section 4.4.12 for a discussion on troubleshooting the thermal management system.
- Before you open the door, check the flow rate at the AQM 65 gas inlet and record the flow rate you measured in the journal. If the flow rate is outside of the expected range then you must find the cause. See 4.4.3.1 for a discussion on troubleshooting flow rates.
- If the flow rate is within the expected range, Table 1-1 then open the door and replace the gas inlet filter with a new filter and then close the door, try to minimise the time the door is open so the sensors can quickly re-stabilise. Then measure the flow rate again to make sure the filter was installed correctly.
- If the flow rate is outside the expected range then there may be a leak or a blockage which must be fixed before continuing on with the calibration. See Section 4.4.3.1 for troubleshooting flow, and record the flow rates of the individual modules in Table 6 after correcting the flow.

**NOTE:** Changing the gas inlet filter requires opening the AQM 65 door which will cause a temporary instability in the AQM 65 internal temperature and also the sensors, the door should kept closed for as long as possible and only open for a brief moment when changing the filter.

If the door is left open for the purpose of finding a leak or replacing a module, this will result in the gas modules becoming unstable and a calibration will not be possible. If this happens close the door and wait 1 – 2 hours to allow the sensors to re-stabilize.

**Note:** Both the AirCal 1000 and the Ozone calibrator take time to warm up and become stable.

- Turn on the AirCal 1000 and switch on the pump override switch on the back panel for at least 30 mins before starting the calibration.
- Turn on the Ozone generator and set it to deliver 0.1 ppm Ozone for at least 30 mins before starting the calibration, this allows time for the lamp in the ozone generator to stabilise at 0.1 ppm.



## 5.7.5 Setting up calibration equipment

The following section describes the different equipment configurations required for zero and span gas calibration.

### 5.7.5.1 Zero calibration using the AirCal 1000.

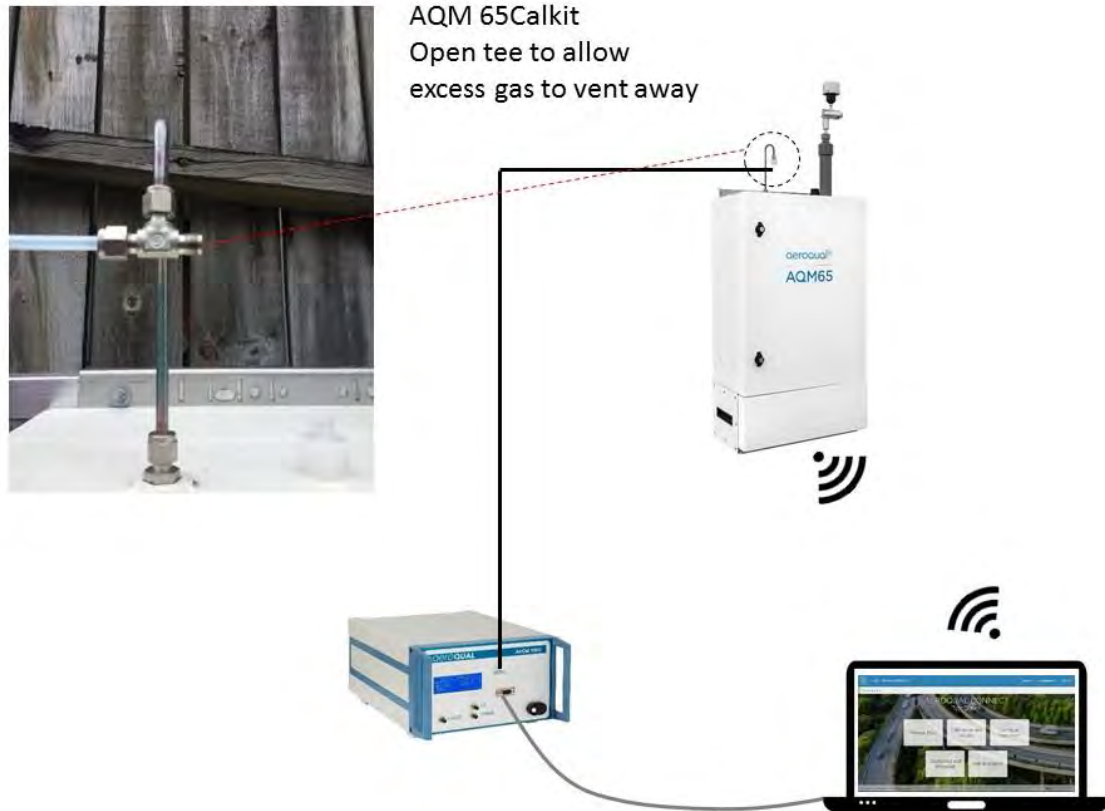
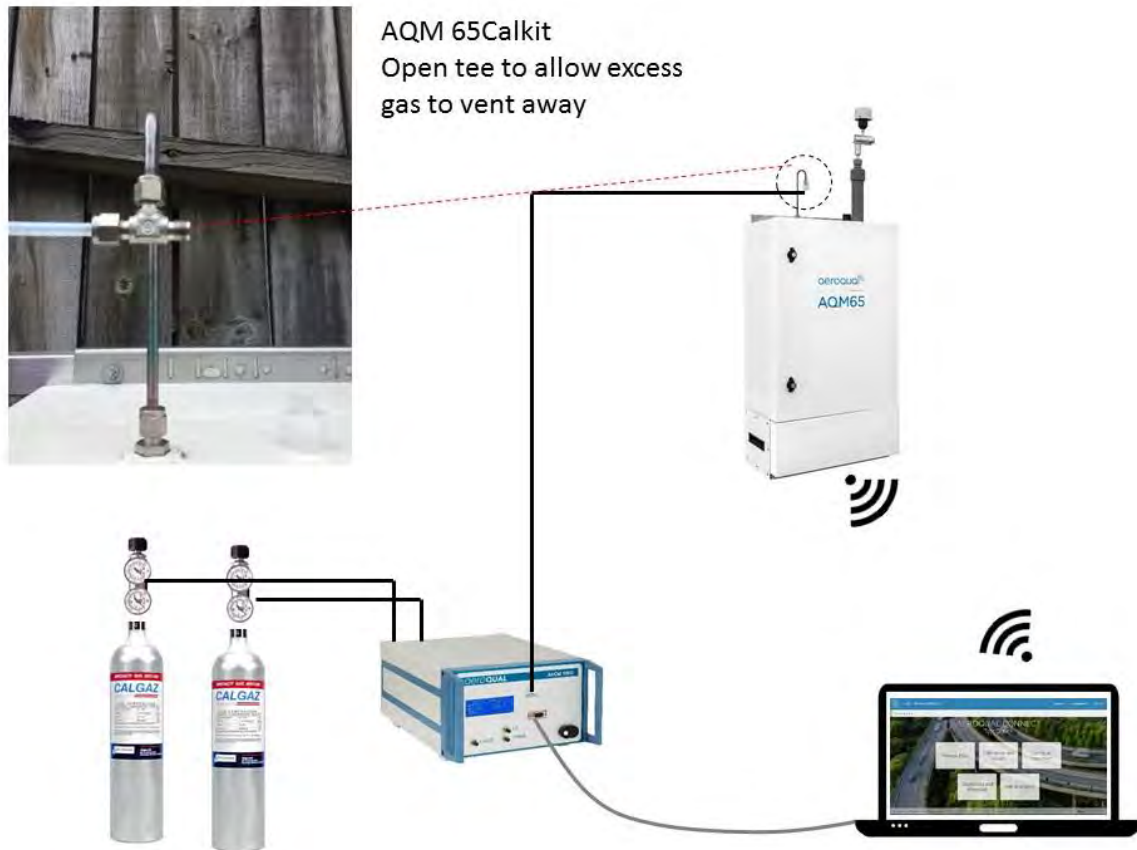

Figure 5-11 Setup to perform zero calibration with AirCal 1000

- The outlet of the AirCal 1000 is connected to the inlet of the AQM 65 using the tee fitting at the end of the AQM 65 CALKIT.
- The tee is "open" to allow excess flow out from the tee.
- The AirCal 1000 can be controlled using desktop software and a USB cable, or using the button on the front panel.
- The AQM 65 Service and Calibration App (Connect or Cloud) is used to change offset and gain.

**Note: The AQM 65 must be calibrated using zero air, N2 can not be used for zero calibration.**

### 5.7.5.2 Span calibration using the AirCal 1000.



**Figure 5-12 Setup to perform span calibration with AirCal 1000**

- The outlet of the AirCal 1000 is connected to the inlet of the AQM 65 using the tee fitting at the end of the AQM 65 CalKit.
- The tee is “open” to allow excess flow out from the tee.
- Calibration gas cylinders are connected to the back of the AirCal 1000.
- The AirCal 1000 can be controlled using desktop software and a USB cable, or using the buttons on the front panel.
- The AQM 65 Service and Calibration App (Connect or Cloud) is used to change offset and gain.

### 5.7.5.3 Span calibration using the AQM O3CAL ozone calibrator

The Aeroqual gas dilution calibrators cannot be used to span calibrate the Ozone module, however the **zero** calibration can be performed using the Aeroqual calibration systems.

Ozone is a highly reactive and unstable gas which means it cannot be put into a cylinder. Ozone must be generated by an ozone calibrator and then delivered directly to the AQM 65. Aeroqual recommends the Model 306 Ozone Calibration Source shown in Figure 5-3. This can be purchased directly from Aeroqual with part number **AQM O3CAL**.



Figure 5-13 Setup to perform span calibration with Ozone calibrator

- The outlet of the Ozone calibrator is connected to the inlet of the AQM 65 using the tee fitting at the end of the AQM 65 CALKIT
- The tee is “closed” This is required because there is a tee inside the Ozone generator.
- The Ozone generator can be controlled using the buttons on the front panel
- The AQM 65 Service and Calibration App (Connect or Cloud) is used to change offset and gain.

**Note:** Both the AirCal 1000 and the Ozone calibrator take time to warm up and become stable.

- Turn on the AirCal 1000 and switch on the pump override switch on the back panel for at least 30 mins before starting the calibration.
- Turn on the Ozone generator and set it to deliver 0.1 ppm Ozone for at least 30 mins before starting the calibration, this allows time for the lamp in the ozone generator to stabilise at 0.1 ppm.

#### 5.7.5.4 Zero and span calibration using the AirCal 8000



**Figure 5-14 Setup to perform a zero and span calibration using the AirCal 8000**

- The regulator valve on the gas cylinders must be open.
- When you are delivering zero or span gas you should measure excess flow out from the tee.
- The AirCal 8000 is controlled using the Connect/Cloud software.
- The AQM 65 Service and Calibration App (Connect or Cloud) is used to change offset and gain.

### 5.7.5.5 Calibration section of Connect / Cloud software

Aeroqual Connect / Cloud software (Version 1.12 and above), has two sections: “Manual Entry” and “Calibration” The manual entry section is shown in Figure 5-15, it displays all of the offsets and gains for all of the configured sensors, and it displays any additional calibration parameters such as the **a** value which is associated with the NO<sub>2</sub> channel (if you have the O<sub>x</sub>/O<sub>3</sub> system). All of the gains, offsets and **a** value can be edited here in the Manual Entry section. This is where the instrument is put into service mode.

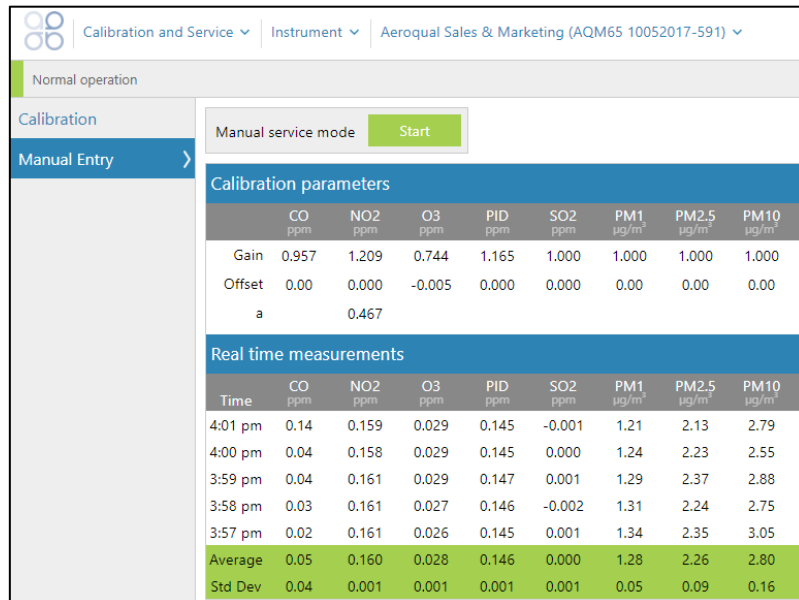

Figure 5-15 The Manual Entry screen of the Calibration and Service app

The second section of the Calibration and Service App is the “Calibration” section. The calibration section allows the calibration engineer to focus on a single gas channel while that gas is being calibrated. The calibration section interface is shown in Figure 5-16. The channel of interest is selected from the list on the left side and then the average and standard deviation is shown on the right side.

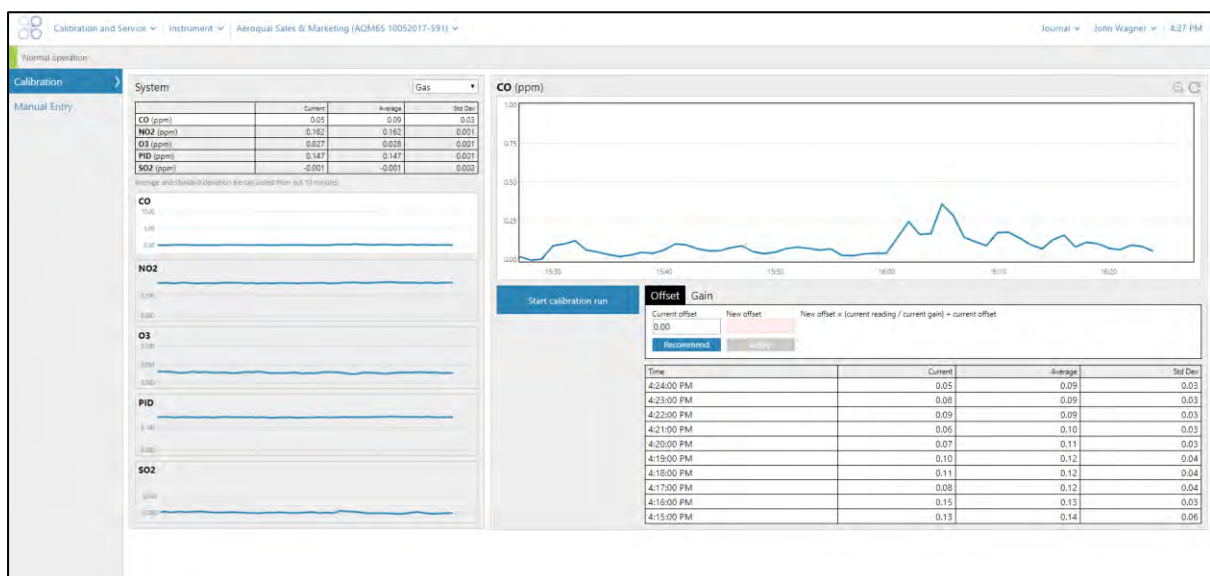

Figure 5-16 The Calibration section of the Calibration and Service App

The calibration engineer can select a gas channel and see the response of the gas in a real time line plot or in a real time table. The average and standard deviation readings are shown in the table in the bottom right of the Calibration section.

The Calibration section has a “Recommend” button which will calculate the offset or gain, the engineer must apply the offset or gain which is calculated.



## Define your calibration run

The Calibration section can be used with the Aeroqual 8000 or with the Aeroqual 1000 (or with any other external calibrator)

If you have an external calibrator such as the Aeroqual AirCal 1000, you can define your calibration run by entering in the sequence and the timing of each point in to the calibration run configurator. To do this push the Start Calibration Run button shown in Figure 5-16. Figure 5-17 shows a typical calibration sequence.

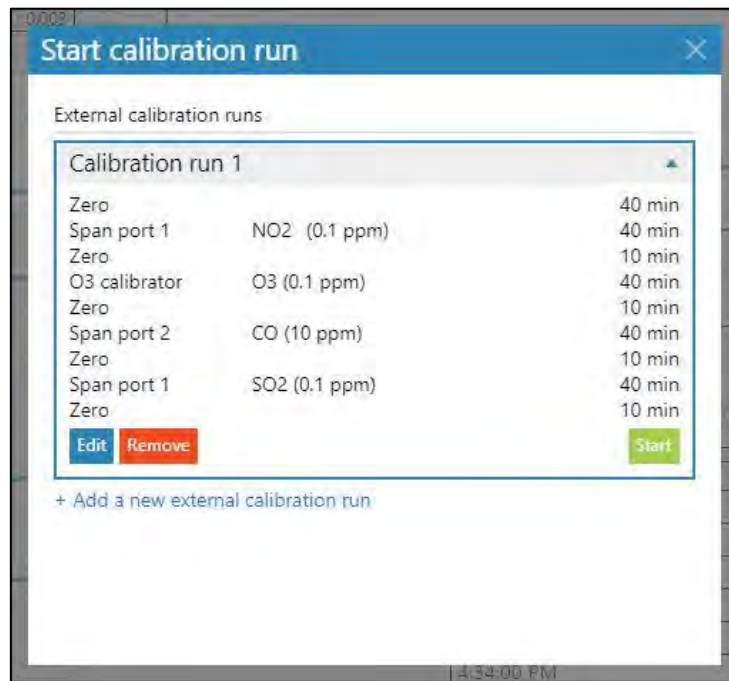

Figure 5-17 The calibration run configurator

**Note:** There is no communication between an external gas dilution calibrator such as the AirCal 1000 and the AQM 65, so the calibration run described here is the **expected** sequence. The calibration engineer must change the points manually on the external calibrator.

The first point in Figure 5-17 is defined to be zero air for 40 mins. When this calibration run is started the calibration software will expect zero air to be delivered for the first 40 mins. This allows the calibration software to calculate an offset when the user pushes the "Recommend" button shown in Figure 5-16. The user can then accept the recommended offset and apply it for the gas channel they are calibrating.

The engineer can select each of the measurement channels one by one and then push the recommend button to have a recommended offset, and then apply the offset for that channel.

If the zero calibration process is completed before 40 mins, the engineer can skip to the next point, or if the AQM 65 requires longer to stabilise towards zero air then the point can be extended.

The second point in the sequence in Figure 5-17 is NO<sub>2</sub> at 0.1 ppm for 40 mins. The system will expect 0.1 NO<sub>2</sub> calibration gas to be delivered for 40 mins, this will allow the Calibration software to calculate a new gain for the NO<sub>2</sub> direct measurement module or the O<sub>x</sub> measurement module.

If the Aeroqual AirCal8000 is being used, then the calibration run will execute automatically.

## 5.7.6 Perform the zero calibration

Record the results from the Zero calibration in Table 7 in the Calibration Form in Appendix 7

Note: The AQM 65 must be calibrated using zero air, N2 can not be used for zero calibration.

The zero calibration can be performed upon all gas modules simultaneously because all gas modules are sampling the same zero air source, (the exception is CO<sub>2</sub> which is zero calibrated separately, see Appendix 4). It takes approximately 30 to 40 minutes for all of the sensors to stabilise towards zero air, after which all offsets can be changed quickly one after the other using either the “Manual Entry” section or the “Calibration” section.

### 5.7.6.1 Wait for the module response to stabilise towards zero air

It is very important to wait until the gas modules have stabilised before deciding if any offset changes are necessary. Figure 5-18 shows the calibration and service real time readings in the “**Manual Entry**” section in the Calibration and Service App. The average and standard deviation readings over a ten minute period for all sensors are highlighted in green in the bottom of the table.

Note that the bottom row is added here for demonstration; this is not reported in the software.

The same information is also reported in the “Calibration” section for a single sensor.

It is the job of the calibration engineer to decide if the sensors are stable or not, and then apply the offsets if required.

Real time measurements						Last 10 readings
Time	CO ppm	NO <sub>2</sub> ppm	NO <sub>x</sub> ppm	O <sub>3</sub> ppm	SO <sub>2</sub> ppm	PID ppm
10:45 p.m.	0.404	-0.003	-0.011	0.001	0.085	0.801
10:44 p.m.	0.404	-0.003	-0.012	0.002	0.061	0.793
10:43 p.m.	0.403	-0.002	-0.011	0.001	0.103	0.803
10:42 p.m.	0.402	-0.002	-0.010	0.002	0.067	0.791
10:41 p.m.	0.402	0.000	-0.012	0.001	0.089	0.808
10:40 p.m.	0.401	0.001	-0.011	0.001	0.102	0.802
10:39 p.m.	0.338	0.002	-0.010	0.002	0.071	0.796
10:38 p.m.	0.336	0.003	-0.012	0.001	0.101	0.800
10:37 p.m.	0.336	0.003	-0.011	0.001	0.065	0.795
10:36 p.m.	0.335	0.004	-0.010	0.002	0.106	0.800
10:35 p.m.	0.333	0.005	-0.011	0.001	0.068	0.792
Average	0.372	0.001	-0.011	0.001	0.083	0.798
Std Dev	0.035	0.003	0.001	0.001	0.018	0.005
Is the sensor stable?	No, readings still increasing	No, readings still decreasing	Yes, readings are stable	Yes, readings are stable	No, readings are noisy	Yes, readings are stable

Figure 5-18 Stability is determined by looking at the standard deviation over a ten minute period in either the Manual Entry section (shown here) or in the Calibration section for a single channel.

#### Assessment of stability

CO sensor module values are still increasing (drifting upward) leading to a higher than acceptable standard deviation.

NO<sub>2</sub> sensor module values are still decreasing (drifting downward) leading to a higher than acceptable standard deviation.

You must wait for CO and NO<sub>2</sub> to stabilise before deciding if an offset is required.

NO<sub>x</sub> sensor module is stable. This module is ready to be assessed, for an offset adjustment.

The SO<sub>2</sub> value are neither drifting upward or downward but the values are noisy which has led to a high standard deviation, this module might be faulty.

### 5.7.6.2 Decide if a zero offset adjustment is required

After the readings have stabilised, then you must decide if an offset adjustment is required.

Table 7, column 7.2.3 (b) in the Calibration form provides some guidelines on what are acceptable zero readings which don't require an offset adjustment, these are different for each module.

If the average readings are within acceptable limits then an offset adjustment is **not required** for the module.

In the example above the NOx module and the Ozone readings are stable, (Figure 5-18) and therefore we can now ask the question:

**“is an offset adjustment required?”**

If an offset is required, then calculate a new offset using Formula 4.

<b>Formula 4 New Offset = Current Offset + (Gas module reading / Gain)</b>
--

You can calculate the offset manually using a calculator or you can use the “Recommend” button in the Calibration section shown in Figure 5-16.

To calculate the new offset manually you will need to know

- Current offset
- Current Gain
- Module 10 minute average reading

Table 7 column 7.2.4 (b) provides recommended guidelines on limits to the offset adjustment for each gas channel.

### 5.7.6.3 Upload the new offset and check the offset has been applied correctly

If you are using the “Manual Entry” section, Figure 5-15, then the new calculated offset is uploaded by clicking in the appropriate cell, and changing the valve then saving.

If you are using the “Calibration” section Figure 5-16 then the new offset is applied by pushing the “Apply” button.

It might take several minutes for the offset to be applied and to see the changed readings.

**NOTE:** All offset and gain adjustments are recorded in the instrument journal automatically, it is not required to record these changes manually in the journal.

**Record all the results from the zero calibration in Table 7 in the Calibration Form in Appendix 7.**

There may be times when either the module does not stabilise, or a very large positive or negative offset is calculated.

Make a note of this in the journal, and then carry on with the rest of the zero calibration and span calibration, do not open the door to check the module because this causes temperature instability.

## 5.7.7 Perform the span calibration

The span calibration is performed for each gas modules in sequence, one at a time. Each gas module will take between 20 and 40 minutes to calibrate with span gas.

Record the results of the span calibration in Table 8 of the Calibration Form in Appendix 7.

If your AQM 65 includes the O<sub>2</sub>/O<sub>3</sub> system then these modules must be span calibrated first, see Section 5.7.3.1 for a description of the order.

This also requires calculating and setting the **a** value, according to Formula 3. The **a** value must be calculated manually and set in the Manual Entry section of the Calibration and Service App, see Figure 5-15

### 5.7.7.1 Choose your span gas concentration

Table 5-1 provide a list of recommended span gas concentrations for each gas. The calibration engineer can choose a span gas concentration which best suits their calibration needs:

Two possible approaches to choosing a span gas concentration are:

- A span gas concentration can be chosen which best represents the concentrations expected at the measuring site.
- A span gas concentration can be chosen which is at 80 % of the full measurement range of the module. This is an approach specified by some manufactures and is written in to the standard operating procedures of some municipal monitoring networks based on reference monitoring equipment.

#### For example:

At your measurement location the range of CO concentrations measured are between 1 and 8 ppm with an average of 4 ppm.

You might choose to calibrate the CO module at 5 ppm which in the middle of the expected measurement range and just above the average expected concentration.

Or you might just calibrate the CO module at 20 ppm which is 80 % of the full range (0 to 25 ppm).

**NOTE:** Aeroqual recommends that a span concentration be chosen which is representative of the concentrations expected at the monitoring site.

You should choose your Span gas concentrations before starting the calibration and enter these in to the Calibration Run dialogue, see Figure 5-17.

Record the span gas concentration in the Span point column in Table 8 of the Calibration form.



### 5.7.7.2 Wait for the module response to stabilise towards the span gas

It is very important to wait until the gas module has stabilised before deciding if a gain change is necessary. The measure of stability is the standard deviation across the last ten measurements, this is shown in the Calibration and Service app in the “Manual Entry” section and also in the “Calibration” section of the Service and Calibration App.

Stable means that the reading are not increasing or decreasing and that the standard deviation is with acceptable limits. The acceptable standard deviation is defined as a percentage of the response of the sensor module toward the calibration gas.

Table 8 column 8.1.5(b) in the Calibration form provide guidelines for stability for each gas channel.

Record the stabilised readings in column 8.1.5 in Table 8 of the calibration form.

Real time measurements						Last 10 readings
Time	CO ppm	NO2 ppm	NOx ppm	O3 ppm	SO2 ppm	PID ppm
10:45 PM	9.180	0.002	0.003	-0.001	0.002	0.002
10:44 PM	8.992	0.001	0.002	0.000	0.001	0.002
10:43 PM	9.184	0.003	0.004	-0.001	0.000	0.001
10:42 PM	9.018	0.001	0.003	-0.002	0.002	0.001
10:41 PM	8.880	0.001	0.002	0.000	0.001	0.002
10:40 PM	9.035	0.002	0.003	0.001	0.000	0.000
10:39 PM	8.974	0.001	0.003	0.001	0.002	0.001
10:38 PM	8.796	0.003	0.003	0.000	0.001	-0.001
10:37 PM	9.084	0.002	0.002	0.001	0.001	0.000
10:36 PM	9.192	0.001	0.001	-0.001	0.000	0.000
10:35 PM	8.850	0.001	0.002	0.000	0.001	0.000
Average	9.017	0.002	0.003	0.000	0.001	0.001
Std Dev	0.137	0.001	0.001	0.001	0.001	0.001
Is the sensor stable?	Yes, readings are stable					

Figure 5-19 Response of the CO module towards 10.00 ppm CO

In the example given in Figure 5-19, the CO sensor module is being calibrated at a span point of 10.00 ppm CO. After 30 minutes the readings have stabilised at 9.017 ppm. In the example in Figure 5-20, the O<sub>3</sub> sensor module is being calibrated at a span point of 0.1 ppm O<sub>3</sub>, the readings are not yet stable because the readings are still rising.

Real time measurements						Last 10 readings
Time	CO ppm	NO2 ppm	NOx ppm	O3 ppm	SO2 ppm	PID ppm
10:45 PM	0.021	0.002	0.003	0.101	0.002	0.002
10:44 PM	0.001	0.001	0.002	0.099	0.001	0.002
10:43 PM	0.031	0.003	0.004	0.097	0.000	0.001
10:42 PM	0.000	0.001	0.003	0.096	0.002	0.001
10:41 PM	0.002	0.001	0.002	0.096	0.001	0.002
10:40 PM	0.012	0.002	0.003	0.095	0.000	0.000
10:39 PM	0.036	0.001	0.003	0.093	0.002	0.001
10:38 PM	0.001	0.003	0.003	0.091	0.001	-0.001
10:37 PM	-0.001	0.002	0.002	0.090	0.001	0.000
10:36 PM	-0.020	0.001	0.001	0.087	0.000	0.000
10:35 PM	0.012	0.001	0.002	0.085	0.001	0.000
Average	0.009	0.002	0.003	0.094	0.001	0.001
Std Dev	0.016	0.001	0.001	0.005	0.001	0.001
Is the sensor stable?				No, readings are still rising		

Figure 5-20 Response of the O<sub>3</sub> module towards 0.1 ppm Ozone



### 5.7.7.3 Decide if a gain adjustment is required

After the readings have stabilised, you must decide if a gain adjustment is required.

If the average readings for a gas module are within acceptable limits then an adjustment is not required for that module.

If the 10 minute average readings are outside acceptable limits then a new gain is required.

Column 8.1.5 (b) in Table 8 in the Calibration Form provides guideline for acceptable readings which don't require a gain change for each module.

### 5.7.7.4 Calculate a new gain, and decide if the gain should be applied

If the average readings are outside the acceptable limits then a gain change is required.

The formula for calculating a new gain is:

$$\text{Equation 5: New Gain} = \text{Current Gain} \times (\text{Span gas concentration} / \text{Module reading})$$

You can calculate the new gain manually using a calculator, or you use the "Recommend" button in the Calibration section. If you use the "Recommend" button you will need to push the "Apply" button to apply the new gain.

To calculate the new gain you will need to know the

- Span gas concentration
- Current Gain
- Module reading

### 5.7.7.5 Summary

Steps 5.7.7.1 to 5.7.7.4 are performed separately for each gas measurement module in sequence.

You should include a 10 minute zero air step between each span point to clear the gas lines, as Shown in Figure 5-17.

If the AQM 65 contains an O<sub>x</sub>/O<sub>3</sub> system then the correct order must be flowed as described in Section 5.7.3.1. During the Ozone span calibration step, NO<sub>2</sub> a value needs to be calculated and applied as discussed in 5.7.3.1.

Record the a value in Column 8.1.6(b) in Table 8

After the O<sub>x</sub> and O<sub>3</sub> modules have been calibrated, the remaining modules can be span calibrated.

## 5.7.8 Record your results in the Journal

Calibration results should also be recorded in the journal using the user entry option. The software will automatically record offset and gain changes, but details about the equipment used and the gas cylinders can be recorded in the journal manually.

Figure 5-21 is an example of a journal entry for an AQM 65 gas calibration.

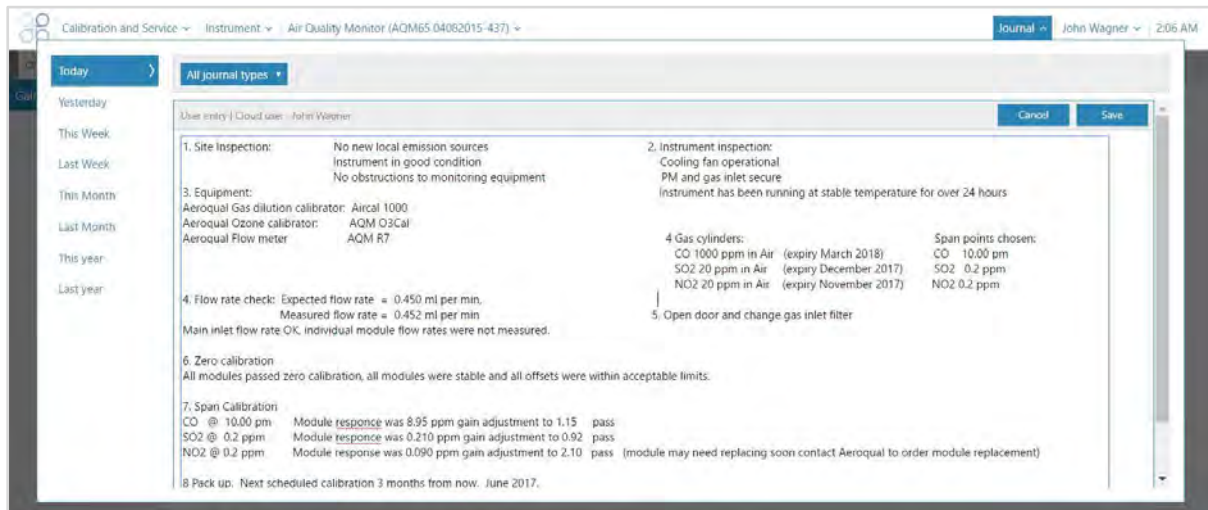

Figure 5-21 Use the journal to record details about the calibration that are not automatically captured by the instrument software

## 5.7.9 Pack up and final instrument checks, schedule the next calibration

- Pack up the calibration gear.
- Lock the AQM 65 door.
- Do a final flow check.
- Schedule the next calibration.

## 6 Particle Monitor calibration

Field calibration of AQM 65 with Particle Monitor or Particle Profiler modules is only recommended for applications that have very high data quality objectives, such as:

- Supplementary monitoring to a reference network (so inter-comparison to reference is important)
- Research studies that need to demonstrate traceability to another instrument
- Consultancy projects that need to demonstrate traceability to another instrument

**In summary, field calibration of Aeroqual PM instruments is recommended when comparison or traceability to reference PM instruments is an important factor in the monitoring project.**

**For all other applications the Aeroqual factory calibration is sufficient.**

All PM instruments are calibrated at the factory against a standard aerosol ('Arizona Road Dust'). The factory calibration is traceable and results in good data quality when the instrument is operated in accordance with Aeroqual's servicing and maintenance procedures.

### 6.1 Factory Servicing

Factory servicing includes cleaning and calibration of the PM module only. The PM module can be removed from the instrument and returned to the factory. All Aeroqual PM Modules need to be returned to the factory for service and calibration at the following intervals:

- AQM 65 Particle Monitor: **24 Months**
- AQM 65 Particle Profiler: **12 Months**

**NOTE:** Field calibration is not a substitute for the specified factory service intervals above. Factory servicing is essential maintenance, and checks the 'health' of the internal components.

### 6.2 Field Calibration

In order to perform a field calibration, your Aeroqual instrument must be located at the same site as a **Reference** PM instrument. This is called '**Co-location**' and is widely performed in ambient air quality monitoring to assess the performance of a new instrument. The two instruments are operated for a given period of time, and their data are compared. An adjustment factor, called '**K Factor**' is then calculated, and applied to the Aeroqual instrument **Gain**. This corrects the data to the known reference instrument.

$$K \text{ Factor} = \frac{\text{Average PM (Reference)}}{\text{Average PM (Aeroqual)}}$$

The K Factor is the applied to the instrument, using the Gain setting for each PM channel:

$$\text{New Gain} = \text{Old Gain} \times K \text{ Factor}$$

You can also perform the adjustment in Microsoft excel or similar.

**Field calibration is only as good as the reference data which is used.** Using poor quality reference data for calibration will result in poor quality PM data from your Aeroqual instrument. Aeroqual recommends that calibration only be carried out using high quality Reference PM Data. If you don't have access to a reference instrument, or aren't confident that you can access a well-run reference instrument, then you should always rely upon the factory calibration.

**Important considerations for field calibration:**

- **Location of instrument:** The Aeroqual instrument and the Reference instrument need to be located at the same site preferably with their inlets within 10m of each other, and must be sampling at the same height. At reference sites using a monitoring shed, on the rooftop of the shed is usually the best location.
- **Instrument set up:** Both the Aeroqual instrument and the reference instrument need to be set up in accordance with the manufacturer's recommendations, with correctly set flow rates and

fresh filters. If you are using a gravimetric method reference instrument, you must follow appropriate filter conditioning and weighing methods.

- **Duration of colocation:** As a general rule, longer is better, as this will give you more data points and therefore more confidence in your field calibration. It's important that the colocation is carried out during the same environmental conditions expected during deployment. **Two weeks is ideal, and no shorter than 72 hrs.**
- **Reference instrument selection:** Selection of the right reference instrument is critical for a successful K factor correction. Ideally, reference instruments should be operated in accordance with local reference method specification. Instrument methods are listed below, in descending order of preference:
  - BAM / TEOM: Are ideal as they are continuous methods, meaning more data can be collected in a shorter period of time, giving a more accurate K-Factor. BAM data can be noisy at hourly averages, so consider using 24hr averages. **This is Aeroqual's suggested method, as lots of data can be collected quickly, with no need for expensive lab work.**
  - Partisol / Low volume samplers (47mm Filter): Can also be used, however will need to be run for a longer period of time as they operate on 24hr averages (i.e. 1 data point per 24hrs). Filters must be appropriately prepared and transported. Lab and field blank filters should also be used. Balance accuracy for pre and post weighing should be better than  $\pm 0.0001 \mu\text{g}$ .
  - Other Non-Reference methods (Optical, Open-Path): Existing instrumentation can be used to establish variance between Aeroqual and a known instrument. This method can be used to assess new versus old instrumentation, **but is not a calibration to a reference instrument.**
  - High-Volume samplers: Not recommended due to documented variance between these and other methods and potential for filter contamination.

### 6.3 Steps to perform a K factor correction

Beta Attenuation Monitors (BAM) measure PM loading on a filter tape, using a radioactive source and a detector. The amount of PM measured is proportional to the amount of beta rays which are blocked from passing from the source to detector by the PM on the filter tape. TEOMs use a high precision microbalance with a special filter to calculate PM concentration. BAM and TEOM instruments run continuously and data is available at as low as 10 minute averages. This data can be noisy, so Aeroqual recommend that 1 hour or 24hr averages are used to minimise this noise.

Gravimetric methods (Partisol, Low volume samplers using 47mm filters) have some additional steps. It is critical that correct filter conditioning and pre/post weighing processes are carried out.

- Install and commission your Aeroqual instrument alongside your reference instrument. Operate both instruments together. The longer you collocate the instruments, the better.
- Collect the data from both instruments. Using Microsoft Excel or similar, remove any odd spikes, error, or automated zero calibration data.
- **(Gravimetric only)** calculate your concentrations using the following equation:

$$\text{Concentration} = \frac{\text{Filter weight at end} - \text{filter weight at start}}{\text{Total volume of air sampled}}$$

- Select an appropriate averaging period, 24hrs is usually appropriate. Calculate your averages for both reference and Aeroqual using this formula:

$$\text{Average} = \frac{\text{Sum of readings}}{\text{Number of readings}}$$

The goal is to create an excel spreadsheet, with 1 column of reference data, and 1 column of Aeroqual data, in the averaging period you have selected, for instance 1 hour or 24 hour or 24hr averages for the period of your co location.

Dust Monitor side-by-side calibration data		
10 June to 21 June Monitoring site 1		
Date	Reference Gravimetric, daily mass ug m-3	Aeroqual Dust Monitor daily average ug m-3
10/06/12	12.0	14.8
11/06/12	27.2	43.9
12/06/12	34.5	50.1
13/06/12	10.0	14.9
14/06/12	9.3	15.1
15/06/12	31.7	52.8
16/06/12	43.1	73.7
17/06/12	52.3	73.6
18/06/12	23.2	27.2
19/06/12	10.7	16.2
20/06/12	13.5	15.6
21/06/12	11.9	16.3

- Using Microsoft excel plot your 2 data sets in an x-y scatter plot. Add a trend line and equation as below.

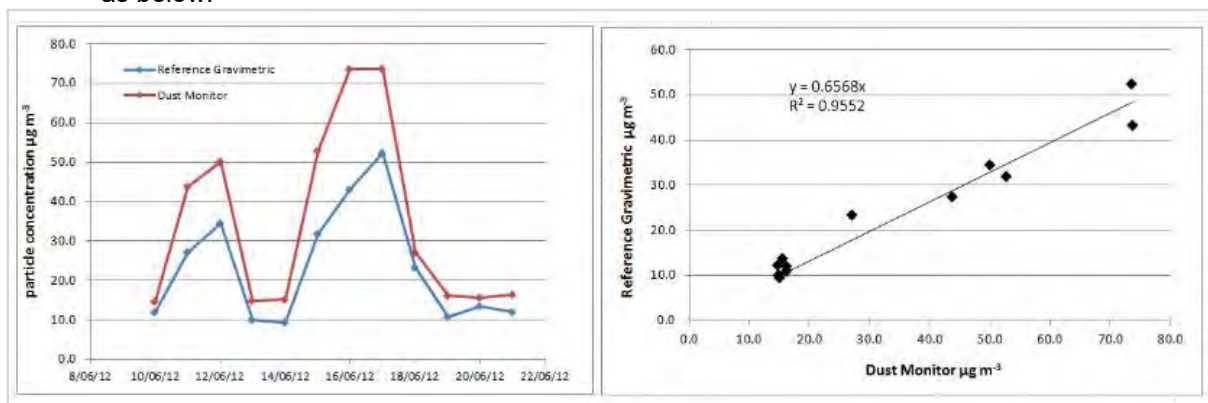

- The graph to the left below shows the time series of the two instruments. The graph to the right below shows the slope calculation. In this example the Dust Sentry is reading higher than the reference instrument. The slope of the curve Reference vs Dust Monitor is 0.6568. So a gain of 0.6568 needs to be applied to the instrument.

The Aeroqual instrument will need a new gain, calculated using the formula below:

$$\text{New Gain} = \text{Old Gain} \times K \text{ Factor}$$

$$\text{New Gain} = 1 \times 0.6568 = 0.6568$$

Upload the new gain into the gain parameter in the gain and offset table using the calibration and service app.

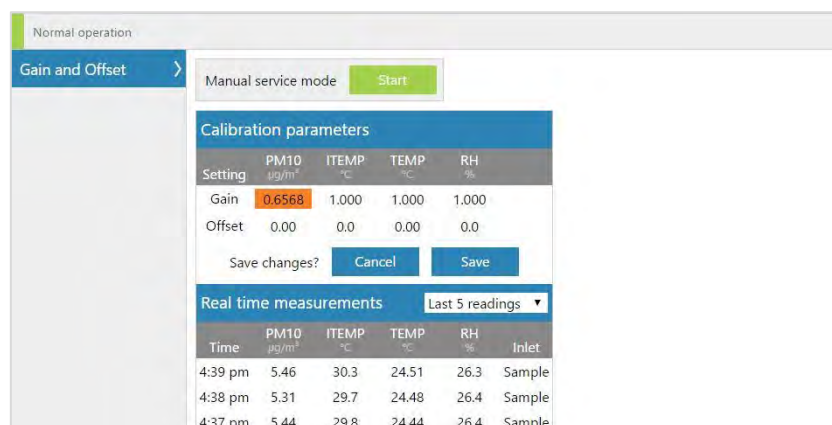



## 7 Appendices

### Appendix 1 Troubleshooting

The following section provides basic troubleshooting for the AQM 65. Common problems, and how to solve them, are given in Table 7-1

Not all known issues are listed in Table 7-1, especially if the issue was not known to Aeroqual when this user guide was written. The Aeroqual training website provides a comprehensive and up to date list of known issues and provides solutions as soon as solutions become available.



Online  
reference

[training.aeroqual.com](https://training.aeroqual.com) AQM 65 Technical Training Section

The Aeroqual technical support team are available to provide assistance when required.



Online  
reference

[technical@aeroqual.com](mailto:technical@aeroqual.com)

#### Use manual sync to assist Aeroqual technical support in troubleshooting

When the Aeroqual technical support team are required to help with troubleshooting it is necessary to see a comprehensive dataset from the AQM 65. This can easily be achieved if the instrument is online.

If the instrument is not online, use the Manual Sync tool (Section 3.4.1) to upload data to Aeroqual Cloud so the technical support team can provide fast and comprehensive support.

#### Error conditions reported by Aeroqual Connect and Aeroqual Cloud software

Connect and Cloud software will report two different types of error condition in the banner at the top of the page, these are ‘sensor offline’ and ‘sensor failed’ The error will also be listed in the AQM 65 journal.

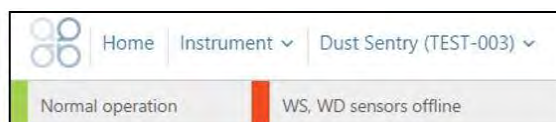

#### Sensor offline

A sensor offline error is usually caused by either a loose power connection or a loose communications connection. Check the module connections are secure. If the power connections and the communications connections are secure then the issue may be inside the module.

Contact your distributor in your local country for initial technical support. If local technical support is unsatisfactory contact the Aeroqual support team: [technical@aeroqual.com](mailto:technical@aeroqual.com).

## Sensor failure

A sensor failure error can occur for different reasons, sometimes this can be related to a sensor parameter exceeding an allowable value.

If you get a “sensor failure” error contact Aeroqual technical support. [technical@aeroqual.com](mailto:technical@aeroqual.com).

## Communication errors:

### 1. Failure to see the WIFI network broadcast by the AQM 65

If you cannot see the AQM 65 in your list of WIFI networks it is most likely because the WIFI setting is set to “Client Mode” and is not broadcasting. See Section 0.

To resolve this, connect to the AQM 65 through the WIFI LAN and then reset the WIFI mode to “access point”.

Alternatively the AQM 65 can be reset to factory communication settings by using the USB reset procedure. See Section 3.3.

### 2. Error 500 Database error

An error is known to occur with the internal database which causes the following error report when trying to connect to the AQM 65. The may be able to be resolved over a remote connection. Or a component in the embedded PC will need to be replaced.



The screenshot shows an "Application Exception" window. The title is "System.Exception" with the message "Unable to connect to database!". The description is "HTTP 500: Error processing request." and the details are "Non-web exception. Exception origin (name of application or object): AeroqualProviders." The exception stack trace is as follows:

```
at Aeroqual.Providers.DataProvider.InitDatabase (System.String connectionString) [0x00000] in <filename unknown>:0
at Aeroqual.Providers.DataProvider.set_ConnectionString (System.String value) [0x00000] in <filename unknown>:0
at AeroqualCloud.WebApiApplication.Application_Start () [0x00000] in <filename unknown>:0
at (wrapper managed-to-native) System.Reflection.MonoMethod:InternalInvoke (System.Reflection.MonoMethod,object,object[],System.Exception)
at System.Reflection.MonoMethod.Invoke (System.Object obj, BindingFlags invokeAttr, System.Reflection.RuntimeBinder binder, System.Object[] parameters, System.Globalization.CultureInfo culture) [0x00000] in <filename unknown>:0
```

If this error occurs contact Aeroqual technical support: [technical@aeroqual.com](mailto:technical@aeroqual.com).

## Internal temperature not stable

The internal temperature should remain stable at the instrument set point. See Section 4.4.12 for how to check and set the internal temperature (ITemp) set point. The ITemp is plotted in the charts, a failure in the internal temperature can be seen in the charts.



Contact [technical@aeroqual.com](mailto:technical@aeroqual.com) for help with resolving issues with the thermal management system.

There is a detailed description of the thermal management system in the online training.



Online  
reference

[training.aeroqual.com](http://training.aeroqual.com) AQM 65 Technical Training Section 3.3

Symptom	Possible cause	Fault isolation / Solution	Reference
<b>Gas module troubleshooting</b>			
Negative readings	Insufficient warm up	Allow AQM 65 to warm up	
	Flow leak or incorrect flow		Section 4.4.3
	Dirty inlet gas filter	Change filter	Section 4.4.2
	Incorrect zero calibration	Perform zero calibration	Section 5.7.6
Gas readings noisy or unstable	Flow leak or incorrect flow		Section 4.4.3
	Module is aging	Replace module	Section 4.4.11
Gas readings significantly different than expected	Incorrect gain or offset applied	Check the correct gain has been applied correctly	
	Incorrect calibration performed	Incorrect gas cylinder used or gain calculated incorrectly	Redo calibration or identify error and correct it
<b>Module specific troubleshooting</b>			
NO <sub>2</sub> or NO <sub>x</sub> values very high	Possible Ozone scrubber failure	Correct or replace scrubber	Contact <a href="mailto:technical@aeroqual.com">technical@aeroqual.com</a>
NO <sub>2</sub> > NO <sub>x</sub>	Incorrect gain or offset applied	Check the correct gain has been applied correctly	
	Incorrect calibration performed	Incorrect gas cylinder used or gain calculated incorrectly	Redo calibration or identify error and correct it
<b>Particle Monitor and Particle Profiler troubleshooting</b>			
PM 2.5 > PM 10	Cyclones fitted on the wrong side	Swap cyclones to correct side	Section 2.2.2
	Auto zero calibration failing on the PM10.0	Check baseline calibration of PM10.0	Section 4.4.7.1
	Incorrect gain applied	Check gain on module	Section 6
	Leak in flow system	Check for leaks	Section 4.4.6.
Negative numbers	Auto zero calibration failing...	Check baseline calibration of PM10.0	Section 4.4.7
Readings lower than expected	Flow rate too low	Check flow rate change pump if required	Section 4.4.5 Section 4.4.9
	Dirty optics	Have optical module serviced	Section 4.5
	Failed laser	Have optical module serviced	Section 4.5
	Dirty sample filters	Change filter	Section 4.4.4gentley

**Table 7-1 Common troubleshooting tasks and how to solve them**

## Appendix 2 AQM 65 dimensions and weight

### AQM65 - Standard

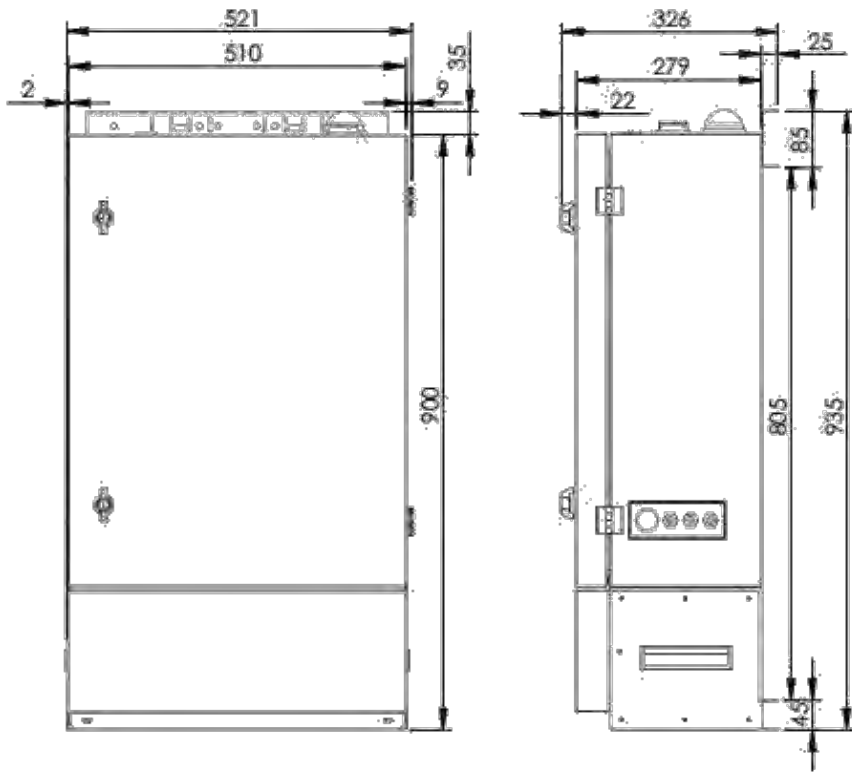

### AQM65 - Aircal

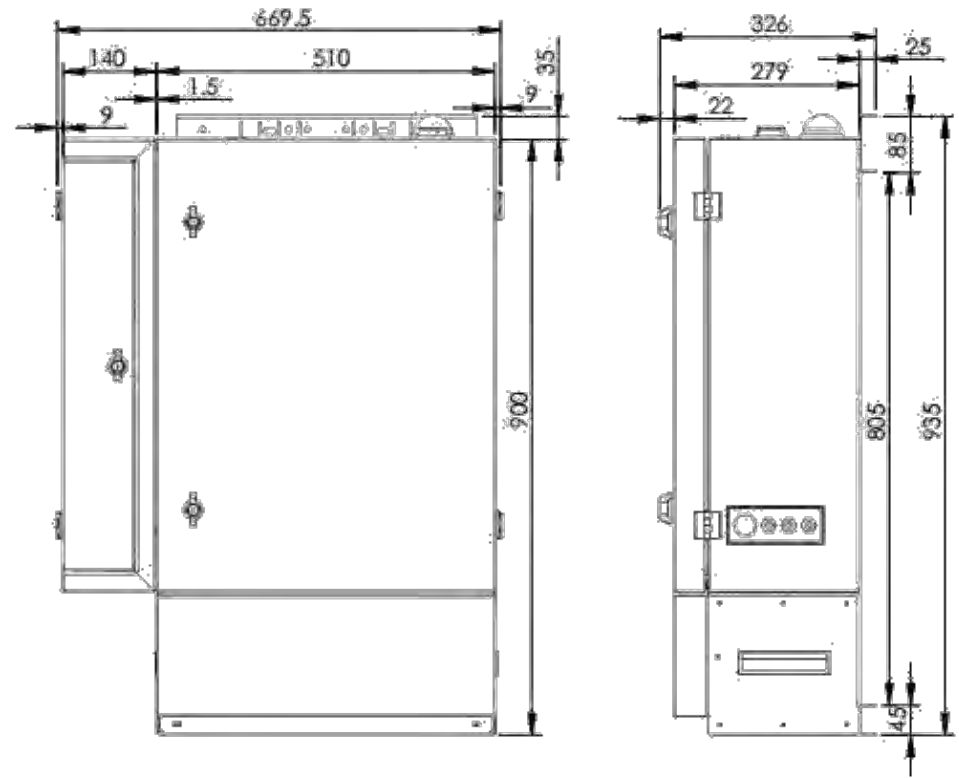

The weight of the AQM 65 is approximately **40 kg (90 lbs)**. See Appendix 5 for mounting guidelines.

## Appendix 3 DC Power consumption of the AQM 65

Occasionally mains AC power is not available at the site where the AQM 65 is installed and an alternative power solution is required. There are two variables which determine the power requirements in Watts (W) for an AQM 65.

- The **number of modules** installed in the AQM 65: more modules demand more power. However the power demand of all the modules combined is small compared to the overall power demand of the AQM 65.
- The **outside temperature (°C)**. The external temperature will place power demands on the thermal management system (TMS), the heaters and compressor used to stabilise the internal temperature of the AQM 65. The power demand of the TMS system is higher than all of the modules combined.







**Average Power:**  $P_{\text{average}}$  [W] Use this to calculate long-term power consumption.

**Peak electrical power:**  $P_{\text{max}}$  [W] Use this to calculate max power required.  $P_{\text{max}}$  [W] power demand occurs for short periods of time, but can occur regularly.

Cooling requires more power than heating, therefore the power demands can be greater in hot climates than in cooler climates.

The modules demand power but also generate heat in the AQM, so (counterintuitively) AQMs with more modules may not significantly increase the overall power demand.

Here is a general guide, describing the power demands for AQMs of different module configurations under different external conditions.

			
	-20 °C to 0 °C	0 °C to 25 °C	25 °C to 50 °C
8 to 12 modules 	Power average 60 W Power Max 110 W	Power average 85 W Power Max 140 W	Power average 130 W Power Max 200 W
4 to 7 modules 	Power average 60 W Power Max 100 W	Power average 80 W Power Max 140 W	Power average 125 W Power Max 200 W
1 to 3 modules 	Power average 55 W Power Max 90 W	Power average 80 W Power Max 120 W	Power average 120 W Power Max 190 W

Aeroqual provides an AQM 65 **power demand calculator** (an Excel .xls spreadsheet). You can download the calculator and instructions on how to use it from the AQM 65 online training system. The power demands have been **measured under real conditions** using an environmental chamber capable of achieving the temperature ranges described in the table.



Specific worked example:

Sample AQM 65 module configuration: NOx, CO, O3, PM10.0, WS, WD							
	AQM 65 module power demand				AQM 65 total power		
	Component	Include	P Avg [W]	P Max [W]	Temp [°C]	Pavg [W]	Pmax [W]
	Embedded PC	YES	7.8	10			
	Sample pump	YES	2.3	2.3	-20	85	125
	System manager	YES	2	2	-15	73	125
	Moxa modem	YES	3	3	-10	63	125
	NOx	YES	3.48	9.11	-5	56	126
	NO2		6.42	8.58	0	104	166
	O3	YES	2.79	3.42	5	95	164
	CO	YES	1.56	1.56	10	87	164
	CO2		1.2	1.2	15	89	163
	PM1	YES	4.8	8	20	94	163
	PM1 heater	YES	8.5	8.5	25	98	165
	PM2		4.5	8	30	103	164
	PM2 heater		8.5	8.5	35	126	206
	SO2		1.9	1.9	40	123	209
	H2S		1.9	1.9	45	127	211
PID		1.56	1.56	50	139	216	
AUX	YES	0.7	0.7	52.5	149	224	
AirCal 8000		15	25				
Total module power [W]			<b>48.9</b>	<b>70.6</b>			

To use the calculator type “YES” in the cell next to the module installed in your AQM 65. All AQM 65s will have the Embedded PC, Sample Pump, and System manager. We recommend to include the Moxa modem, the other modules are optional and will be unique to your AQM 65.

Then you can read the average  $P_{avg}$  [W] and  $P_{max}$  [W] for a particular external temperature.

The AQM 65 **power demand calculator** tells us that for this sample AQM 65 configuration running at an ambient outdoor temperature of 30 degrees Celsius, the average total power demand will be 103 Watts and the max Total power demand will be 164 Watts.

Use the calculator to calculate the specific power demands of your AQM 65 under your local temperature conditions.

## Appendix 4 CO2 module calibration

The Aeroqual gas dilution calibrators cannot be used to calibration CO2, this is because the scrubber media does not remove ambient CO2 from the atmosphere. The CO2 module responds very quickly to calibration gas, and is also tolerant of dry ( < 5 % RH ) calibration gas. For these reasons CO2 is the only gas module which can be successfully calibrated by direct injection of calibration gas in to the AQM 65 inlet.

The calibration procedure is performed in exactly the way as for the other gases as described in section 5.7.

CO2 can be zero calibrated by direct injection of zero air from a certified zero air calibration cylinder. Nitrogen (N2) cannot be used to perform a zero calibration of CO2. A cylinder of certified zero air can be purchased from [calgaz.com](http://calgaz.com) part number **A0194363**.

CO2 can be span calibrated by direct injection of CO2 from a calibration cylinder. An example of a suitable gas cylinder for span calibration of CO2 is given in Table 5-1 , Calgaz part number **A0189932**.

The calibration equipment are setup as shown in Figure 7-1

Because the Aeroqual AirCal systems are not being used, a different regulator is required for the direct injection. There are two types of regulators which are suitable, fixed flow or demand flow.

### Fixed or adjustable flow regulator for CO2 zero and span calibration

A fixed flow regulator delivers gas at a fixed flow. The flow rate must be selected at the time of purchase. Aeroqual recommends the 715 series fixed flow meters from [calgaz.com](http://calgaz.com), the 715 series fits on to the zero grade air and CO2 span gas cylinders.

You must purchase a flow meter which has outlet flow rate slightly high than your AQM 65 inlet flow rate. For example if your AQM 65 inlet flow rate is 0.450 LPM, you should purchase the fixed flow regulator with a flow rate of 0.6 LPM.

The Calgaz 1768 variable flow regulator can also be used. This regulator is adjustable, so the outlet flow rate can adjusted to best match the inlet flow rate of the AQM 65.

**NOTE:** When using a fixed flow or adjustable regulator to deliver zero and span gas the connection to the AQM 65 inlet must be via an “open” tee, as shown in Figure 7-2

### Demand flow regulator for CO2 zero and span calibration

A demand flow regulator will allow the AQM 65 to control the flow rate. Eg if the AQM inlet flow rate is 0.45 LPM then the demand flow regulator will deliver exactly 0.45 LPM. The calgaz.com demand flow regulator part number (DFR) 2001 is suitable for use with the zero grade air and CO2 calibration gas.

**NOTE:** When using a demand flow regulator to deliver zero and span gas the connection to the AQM 65 inlet must be via a “close” tee, similar to the connection for Ozone as shown in Figure 7-2.

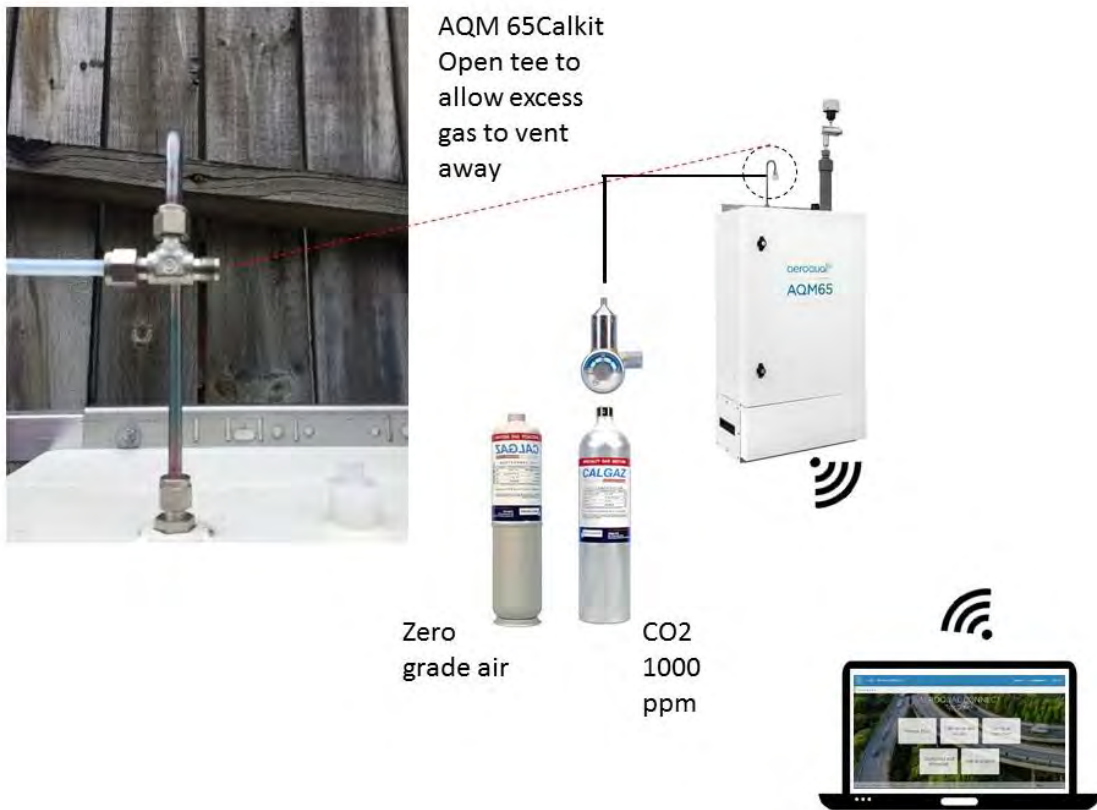

Figure 7-1 Calibration setup for calibrating CO2



Figure 7-2 Left: Closed tee used with demand flow regulator. Right: Open tee used with fixed flow regulator.

## Appendix 5 AQM 65 site installation and commissioning with mounting examples

Commissioning is the process of setting up a new instrument to work correctly on site. It is important that the correct procedure for commissioning AQM 65 instruments is followed to ensure reliable instrument operation and to meet or exceed your data quality objectives. All AQM 65 instruments are supplied with a traceable factory calibration. This calibration is applicable to the commissioning phase and accordingly Aeroqual does not recommend an initial calibration as part of instrument commissioning.

**NOTE:** Aeroqual recommends that instruments are installed and commissioned, and allowed to run with the factory calibration for the first month. Based on this first month of data, an assessment of the installation can be made and a calibration schedule then developed for the instrument and the site.

A commissioning report template (.pdf) is available from the training website: [training.aeroqual.com](http://training.aeroqual.com) **AQM 65 Technical Training Section 2.**



Online  
reference



Recommended commissioning procedure

### Visit potential site and assess instrument location and suitability

Before the instrument arrives ensure that the site will be representative of the pollutants you intend to measure, be secure but with adequate access, and be appropriately open to all wind directions. If you are planning a permanent deployment, check that there is nothing nearby which could change and affect your project – like trees, planned buildings or new roads and other potential interferences.

Both Mains and Solar power can be used, but these will need to be available and installed before the instrument arrives. When installing power outlets (110 VAC to 230 VAC) for the AQM 65, they should be weatherproof and installed safely. Install 2 power outlets, 1 for the AQM 65 and one for calibration equipment.

### Install the AQM 65 on site

See Appendix 2 for AQM 65 dimensions and weight.

Most sites will require a way of securely mounting the AQM 65. Pole Brackets (89 mm / 3 ½ “304 Stainless U-Bolt) are included to mount the instrument on a pole, anchored to the ground. (**Figure 3**) Small platforms have also been used successfully too (**Figure 1**). If you have ordered Auxiliary sensors (Weather, noise etc.) you will need to provide a means of mounting these also.

**Figure 1** Shows an AQM 65 mounted on a steel stand with an extended pole. The AQM 65 is secured to the pole using the pole mounting brackets and the wind sensor is mounted to the top of the pole.

**Figure 2** shows the temperature and humidity sensor on the bottom plate of the AQM and the compressor cooling fan on the back plate, these must have sufficient air flow around them to function correctly.

**Figure 3** Shows an AQM 65 mounted to a pole, an additional power socket is included to allow a laptop or external calibrator to be plugged in.

**Figure 4** Shows a stand with a flat base, and an AQM installation which blocks the fan at the back. These situations must be avoided.

**Figure 5** Illustrates a concept stand and pole for mounting weather sensors.





**Figure 1: The AQM 65 is mounted on a stand and is secured to a pole. A wind sensor (Gill) is mounted to the top of the pole.**



**Figure 2: It is very important to maintain good air flow underneath the AQM 65. The temperature and relative humidity sensor is placed on the bottom plate (right) The AQM 65 should be mounted on an open bottom stand so that air can flow underneath the AQM 65, the cooling fan at the back (left) must also be unobstructed.**





**Figure 3** The AQM 65 is mounted to a pole, an additional power point is added to allow a laptop or Aircal 1000 calibrator to be plugged in.

The two images below illustrate some potential installation problems which will cause problems.

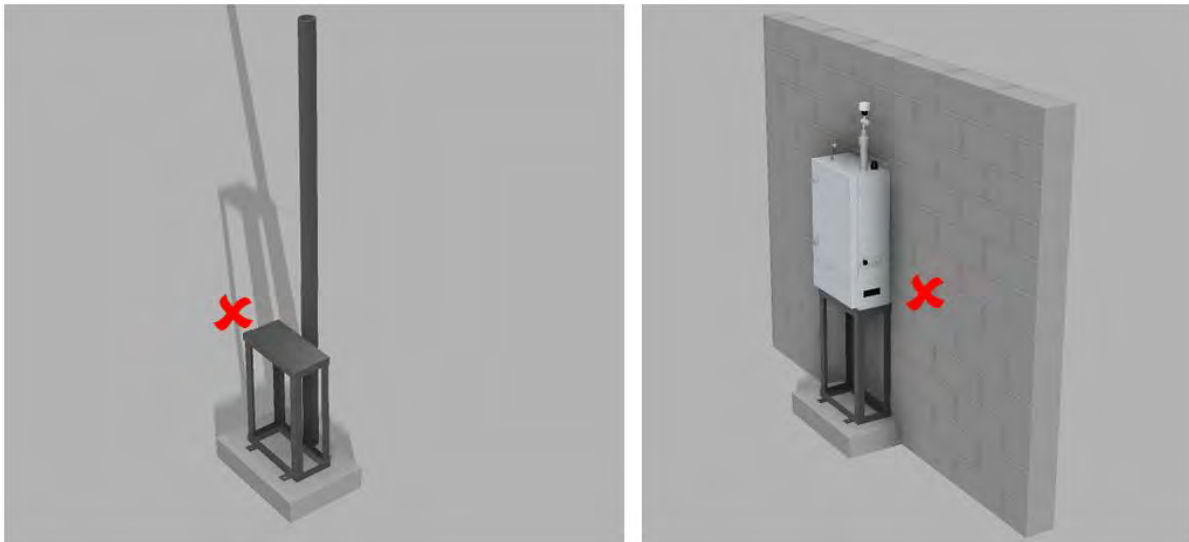
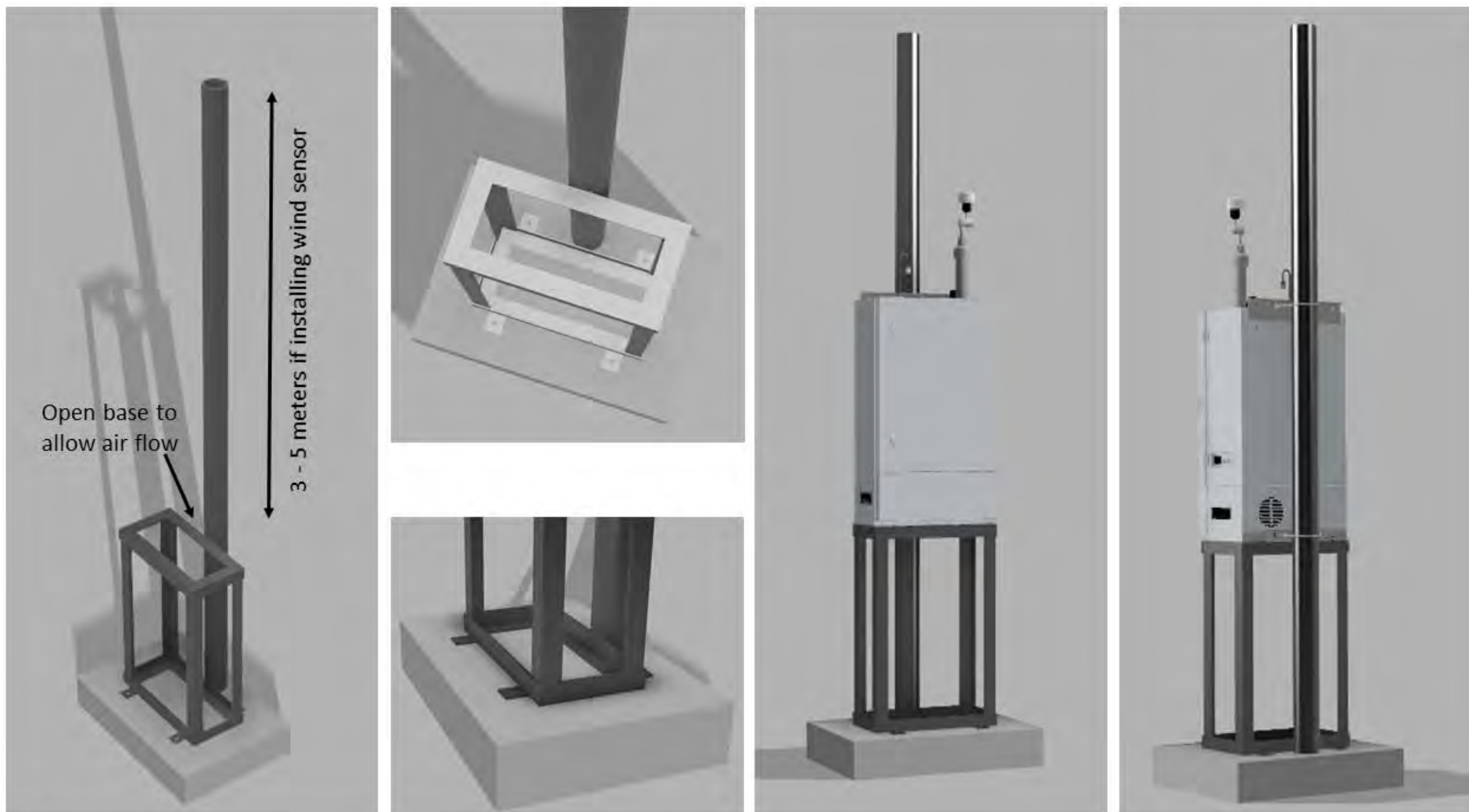

**Figure 4** A stand with close base prevents air flow around the temperature and relative humidity sensor, the cooling fan at the back must be given clearance to prevent overheating of the compressor.

A stand with a closed base will prevent air flow and will also block the temperature and humidity sensor which will lead to higher uncertainty in those measurements.

The AQM has a cooling fan at the back, on the TMS cassette, this must not be blocked as it can lead to overheating of the compressor.

**Design concept for AQM 65 stand with extended pole for mounting metrology sensor**



**Figure 5 A stand with an open base allows air flow around the Temp/RH sensor. The stand is held on a concrete base.**



Mount the instrument to your platform or pole. Assemble the PM inlet and gas inlet, See Section 2.2.2  
Open the door and check that all tubing, power and data connections are secure.

Check that the status LEDs on the modules, Embedded PC and Modem (if fitted) are on and green.  
Check that the Fan at the rear of the instrument is operating. Check that the compressor runs.

Put the instrument into Service mode (See Section 4.3.1) and write a comment in the Journal that you are on site for instrument commissioning.

Check the sampling system for leaks, rectify any leaks

Check gas module flow rates and adjust to specification if required. Check PM inlet flow rates and adjust if required.

If you have purchased any auxiliary sensors (Weather, Noise) mount these and run the cabling through the external glands, and connect to the AUX module. (See Section 2.2.4)

Close door and wait for the ITemp to stabilise. This may take up to 4 hours, depending on ambient temperature. Check that the ITemp stabilises at the set point.

Write a comment in the Journal that commissioning is complete. Exit Service mode.

**NOTE:** It can take many hours (up to one day) for the AQM 65 to fully warm up and provide stable readings. During this time the readings can be negative or outside of what is expected

### **Complete the Commissioning report and provide to customer**

This report details the settings of the instrument at the time of commissioning. The completed report should be provided to the customer, along with the factory logbook which is provided with every AQM 65.

### **During the first month after installation:**

Monitor instrument performance, checking:

- All parameters are responding to ambient air
- No parameters are flat lining
- Power supply is stable
- Communications are stable
- ITEMP is stable at the set point

If these checks show problems, then take steps to resolve the problems.

If the measurements from the instrument do not meet the data quality objectives a calibration may be required. Aeroqual can help you determine if you need to perform a calibration and can guide you through the process. Based on the data from the first month you can plan your ongoing calibration schedule. The following table can be used as a guide to design your calibration schedule

.

## Appendix 6 Gas calibration systems from other suppliers

It is possible to calibrate the Aeroqual gas modules using gas dilution calibrators from other suppliers such as Teledyne, Thermo Fisher or Ecotech. An example of a Teledyne gas dilution calibration system is shown in Figure 7-3.

A disadvantage of these systems is they are not as portable as the Aeroqual AirCal 1000, however some gas dilution calibration systems do include an Ozone generator and have the ability to perform gas phase titrations (GTP).

- The **minimum** dilution amount must be 50 x dilution, if the calibration cylinder is in a balance of nitrogen. If the calibration gas is in a balance of air, then there is no minimum dilution.
- The final span concentration delivered must be in the range specified in Table 5-1. Eg for CO the concentration must be between 5 and 15 ppm, therefore the dilution range of the calibration system must be considered and the concentration of the gas cylinder must be matched to the range of the calibration system.

### Gas phase titration (GTP) considerations

A dilution calibrator with a built in O<sub>3</sub> source will allow a Gas Phase Titration (GPT) of NO to NO<sub>2</sub>. The advantage of this method of generating NO<sub>2</sub> is that it enables the use of the more stable NO gas for NO<sub>2</sub> sensor calibrations. The AirCal 1000 does not have this facility. If you plan to use a calibrator with GPT capability you should only use a small excess of O<sub>3</sub> (<0.025 ppm) because excessive O<sub>3</sub> may adversely affect the NO<sub>2</sub> calibration.

Alternatively use an excess of NO to enable a NO<sub>x</sub> calibration simultaneously. For example, a setting of 0.2 NO and 0.1 O<sub>3</sub> would produce 0.1 ppm NO<sub>2</sub> and 0.2 ppm NO<sub>x</sub>.

### Use of the Aeroqual AQM R41 humidifier with non-Aeroqual calibration systems

Aeroqual's gas sensor calibration can be adversely affected by the very dry (dew point < -20°C) air generated by third party calibration sources. It is strongly recommended that you purchase an AirCal 8000 or AirCal 1000 portable calibrator for calibrating the AQM65. These calibrators are specially designed to optimally prepare the calibration gases for the AQM65. If you are using an AirCal 8000 or an AirCal 1000 you do not need to use the additional Nafion humidifier.

If you are using a third party calibrator with a dry zero air source or a cylinder of zero air then you will need to humidify the calibration gases before they are delivered to the AQM65. Aeroqual supplies with the AQM65 service kit a Nafion humidifier part number AQM R41 for this purpose. It contains a Nafion membrane from Permapure ([www.permapure.com](http://www.permapure.com)) which allows the transport of water molecules across the membrane with high selectivity and no loss of calibration gases.

The placement of the R41 humidifier is shown in Figure 7-4.



Figure 7-3 Left: Ecotech and Teledyne calibration system. Top Right: Drying agent molecular Sieves. Bottom right: Aeroqual R41 humidifier.

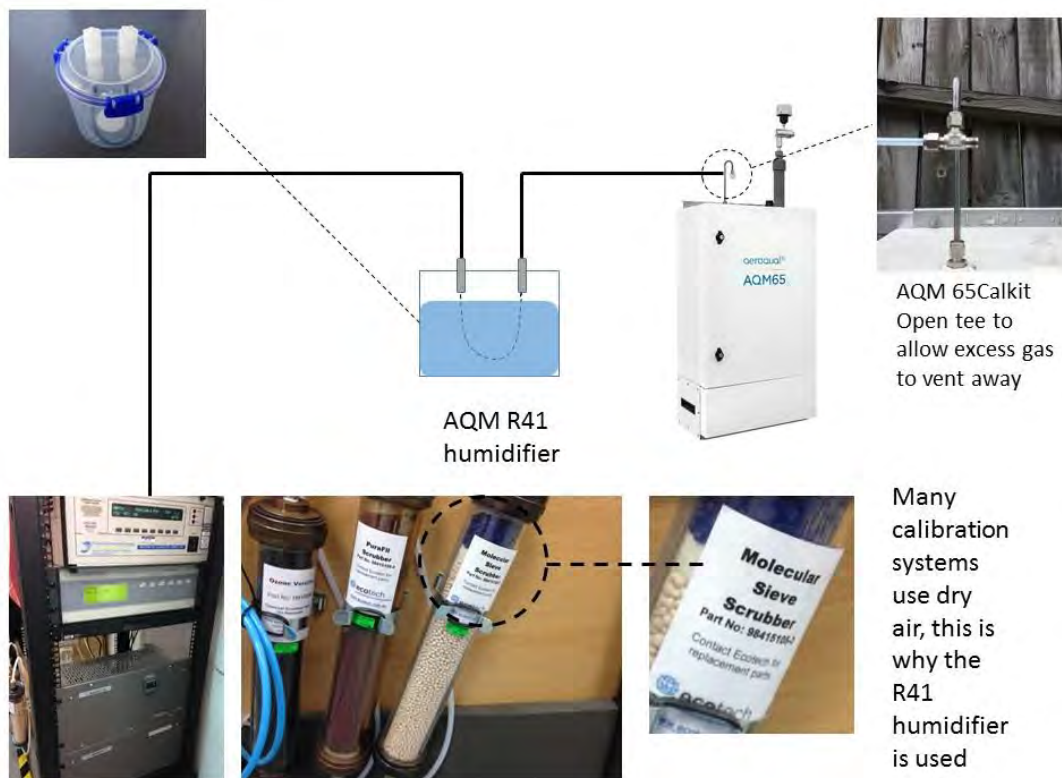

Figure 7-4 The Aeroqual R41 humidifier is placed between the outlet of the calibrator and the inlet of the AQM 65



## Appendix 7 HTTP Web API

Data can be requested from cloud.aeroqual.com or china.aeroqual.com or directly from the instrument using a Web API.

- The API uses POST and GET requests to log on and retrieve data.
- To use the API, the instrument must have the API licence enabled. You can check if your instrument has the API licence enabled by going to the “About” section of the Configure Instrument App
- If you need to use the API but do not have the API licence enabled, then contact Aeroqual.
- You also need to have an API user account, this can be created by your system administrator or Aeroqual can create this account for you.

### API basics:

URL:

https://cloud.aeroqual.com

https://china.aeroqual.com – People’s Republic of China only.

(IP address of local instrument)

### Process

1. Log in (POST /api/account/login) and get authentication token in cookie
2. If required fetch list of accessible instrument serial numbers (GET /api/instrument)
3. If required fetch details of instrument (GET /api/instrument/serial)
4. Download required data (GET /api/data/serial)

To test the API use POSTMAN free Chrome add on:

Below is an example using POSTMAN of a successful login with a username and password. Check for a HTTP 200 response for a successful login.



Aeroqual is always updating the API so for a complete list of API HTTP GET requests please go to our website software section to download the complete API documentation.

## Appendix 7 Calibration results template

### AQM 65 Calibration Results

Table 1: Calibration details	
Date Time	
Serial number	
Date of previous calibration	
Customer name	
Site name	
Engineer name	

Table 2: Equipment details		
Type:	Brand Name / Model number	Serial number
Gas dilution calibrator:		
Ozone generator		
Zero air source		
Flow meter		
Gas Regulator 1		
Gas Regulator 2		

Table 3: Gas cylinder details

	<b>Gas Type</b>	<b>Balance</b>	<b>Manufacturer</b>	<b>Expiry date</b>	<b>Cylinder pressure</b>
1	NO <sub>2</sub>	Air N <sub>2</sub>			
2	Isobutylene	Air N <sub>2</sub>			
3	CO				
4	SO <sub>2</sub>				
5	H <sub>2</sub> S				
6	CO <sub>2</sub>				
7					
8					
9					

**Table 4: Site inspection:** Check the local surroundings to see if anything has changed which could influence the ongoing ambient gas measurements.

Observation

Table 5: Instrument pre checks		
SOP description	Observation / reading	Pass / Fail / done
<b>Before opening the door</b>		
Put instrument into service mode		
Gas inlet secure		
Particle inlet secure		
Door locks are operational		
Record the flow rate (before opening door)		
Previously measured flow rate		

<b>After opening the door</b>		
Replace the inlet filters		
Measure flow rate again		
Go to section 6 <u>if required</u> then record final inlet flow rate here		

It is only required to fill out this Table if the main inlet flow rate was found to be too low.

Table 6: Individual module flow rates, leak check manifold and bypass valve.										
Check all gas connections		Pass Fail								
Leak check sampling manifold		Pass Fail								
		NO <sub>2</sub> /Ox	O <sub>3</sub>	CO	PID	SO <sub>2</sub>	H <sub>2</sub> S	CO <sub>2</sub>		<b>Total module flow</b>
Flow rate last measured										
Flow rate measured now										
If flow rate is the same then <b>pass</b> , if changed then <b>fail</b>		Pass Fail	Pass Fail	Pass Fail						
Adjust bypass valve		If all of the modules show reduced flow and there is no leak then the adjustment bypass valve can be used.				Yes / No				
Flow rate measured following adjustment										
If flow rate is the same as section 6.3 then <b>pass</b> , if changed then <b>fail</b> .		Pass Fail	Pass Fail	Pass Fail	Pass Fail	Pass Fail	Pass Fail	Pass Fail	Pass Fail	Pass Fail
What was the reason for the change in flow rate?										



Table 7: Zero calibration results:

Module	Current offset From instrument settings	Reading after stabilisation 10 minute average	Acceptable reading during zero calibration (ppm) 10 min average	Acceptable standard deviation during zero calibration (10 minute average)	New Calculated offset <sup>1</sup>	Minimum and Maximum recommended offset (ppm)	Offset uploaded	Reading after offset changed	Pass Fail
NO <sub>2</sub>	0.000				N/A	N/A	N/A	N/A	
O <sub>3</sub>			0.000 ± 0.005	0.002		Max +0.050 Min -0.050			
Ox			0.000 ± 0.005	0.002		Max +0.050 Min -0.050			
CO			0.000 ± 0.002	0.002		Max +0.05 Min -0.05			
PID									
SO <sub>2</sub>			0.000 ± 0.002						
H <sub>2</sub> S									
CO <sub>2</sub>									
Comments:									

Equation 4:  $\text{New offset} = \text{Current offset} + (\text{AQM gas reading} / \text{Gain})$

Table 8: Span calibration results:

Module	Initial gain	Initial a value	Span point	Reading after stabilisation 10 minute average	Acceptable range during span calibration (ppm) 10 minute average	Maximum acceptable noise during span calibration 10 min std deviation	Maximum Minimum recommended gain	New gain <sup>5</sup>	New a value <sup>3</sup>	Ratio of gain change New gain / Initial gain	Gain uploaded	Reading after gain changed	Pass Fail
NO <sub>2</sub>	1.000				span ± 5 %	2 % of span	NA	NA		Reading after an adjustment, (should be close to 0.000)			
O <sub>3</sub>		N/A			span ± 5 %	2 % of span	max 5.000 min 0.2		N/A				
Ox		N/A			span ± 5 %	2 % of span	max 5.000 min 0.2		N/A				
CO		N/A			span ± 5 %	2 % of span	max 5.000 min 0.2		N/A				
PID					span ± 5 %	2 % of span	max 5.000 min 0.2						
SO <sub>2</sub>					span ± 5 %	2 % of span	max 5.000 min 0.2						
H <sub>2</sub> S					span ± 5 %	2 % of span	max 5.000 min 0.2						
CO <sub>2</sub>					span ± 5 %	2 % of span	max 5.000 min 0.2						
Comments:													

**Equation 5:  $New\ Gain = Current\ Gain \times (Span\ concentration / Gas\ reading)$**

**Equation 3:  $a = Ox\ reading / O_3\ span\ concentration$**

The Ox module gain adjustment is made during the NO<sub>2</sub> calibration gas delivery  
 The NO<sub>2</sub> a value adjustment is made during the Ozone gas delivery  
 The NO<sub>2</sub> gain value is NOT adjusted as part of the calibration process

**Table 9: Calibration Post-checks**

<b>SOP description</b>	<b>SOP ID</b>	<b>Observation / reading</b>	<b>Pass / Fail / done</b>
Disconnect calibration equipment			
Record total inlet flow rate			
Replace the mesh inlet and cap			
Lock door			
Secure the site			
Service mode			

## 8 Copyright

Copyright Aeroqual Limited. All rights reserved. Reproduction, transfer, distribution or storage of part or all of the contents of this document in any form without the prior written permission of Aeroqual Limited is prohibited.

“Aeroqual” is a registered trademark of Aeroqual Limited. Other product and company names mentioned herein may also be trademarks or trade names.

Aeroqual operates a policy of continuous development. Aeroqual reserves the right to make changes and improvements to any of the products described in this document without prior notice.

Under no circumstances shall Aeroqual be responsible for any loss of data or income or any special, incidental, consequential or indirect damages howsoever caused.

The contents of this document are provided "as is". Except as required by applicable law, no warranties of any kind, either express or implied, including, but not limited to, the implied warranties of merchantability and fitness for a particular purpose, are made in relation to the accuracy, reliability or contents of this document.

Aeroqual reserves the right to revise this document or withdraw it at any time without prior notice. The availability of particular products may vary by region. Please check with the Aeroqual dealer nearest to you.

## 9 Compliance

1. The Aeroqual AQM 65 Monitor complies with EN 61000-6-1:2001
2. The Aeroqual AQM 65 Monitor complies with EN 61000-6-3:2001
3. The Aeroqual AQM 65 Monitor complies with Part 15 of the FCC Rules. Operation is subject to the following two conditions: (1) these devices may not cause harmful interference, and (2) these devices must accept any interference received, including interference that may cause undesired operation.

**NOTE:** This equipment has been tested and found to comply with the limits for a Class B digital device, pursuant to Part 15 of the FCC Rules. These limits are designed to provide reasonable protection against harmful interference in a residential installation. This equipment generates, uses and can radiate radio frequency energy and, if not installed and used in accordance with the instructions, may cause harmful interference to radio communications. However, there is no guarantee that interference will not occur in a particular installation. If this equipment does cause harmful interference to radio or television reception, which can be determined by turning the equipment off and on, the user is encouraged to try to correct the interference by one or more of the following measures:

- Reorient or relocate the receiving antenna.
- Increase the separation between the equipment and receiver.
- Connect the equipment into an outlet on a circuit different from that to which the receiver is connected.
- Consult the dealer or an experienced radio/TV technician for help.



## 10 Warranty

The AQM 65 warranty policy can be found on the main company website:

[www.aeroqual.com/support/warranty](http://www.aeroqual.com/support/warranty).