



XL Flex / XL Flex +TM VideoProbe[®]

Operating Manual



Table of Contents

Chapter 1: Introduction	5
About this Manual	5
Standard Package	5
Optional Accessories	5
Optional Software	5
Indicators, and Connectors.....	7
Controls	8
Chapter 2: Safety Information	10
Symbols and Terms	10
General Warnings.....	10
General Cautions.....	11
Battery Warnings	12
Symboles et termes employés	13
Avertissements généraux	13
Mentions générales « Attention »	14
Avertissements liés à la batterie	14
Chapter 3: Getting Started	16
System Removal	16
System Power On.....	17
System Power Off.....	18
System Storage	18
Mounting Accessories.....	19
Battery	20
Battery Charge Level.....	21
Charging Battery.....	21
Keyboard Support.....	22
Saving Images and Video.....	23
Optical Tips.....	24
Tip Tool Proper Use (4.0 mm only)	25
Chapter 4: Common Tasks	26
GO TO Menu	26
Live Main Menu	34
Input Method Editors	45
Chapter 5: Operation	52
Battery Icon	53
Date / Time	54
Text Color	56
Temp Icon	57
Stereo Tip Utilities.....	60
Units	62
Accuracy Index	63
User Prompts.....	64
Save Location	66
MPEG Quality.....	67

Table of Contents

MIC	68
SETUP	69
Save Location	70
JPEG Quality	72
Playback Volume	74
System Info	79
Power Management	80
Capturing Images and Video	82
Articulation Home	83
Freeze Frame	84
Still Image Capture and Playback	87
Video Recording and Playback	87
File Manager	88
Video Playback Menu	90
Copying Files/Folders	91
Deleting Files/Folders	92
Creating a Folder	93
Renaming Files/Folder	94
Chapter 6: Measurement	95
About Measurement	95
Capturing Measurement Images for Re-Measurement	96
Stereo measurement images can be saved allowing the user to Measurement Procedure	96
Accuracy Index	96
StereoProbe Measurement	97
Comparison Measurement	98
Chapter 7: Maintenance	111
Inspecting and Cleaning the System	111
Cleaning Optical Tips	111
Troubleshooting Measurement	112
Service	113
Chapter 8: Technical Specifications	114
Product Specifications:	114
Appendix	119
A. Optical Tip Table	119
B. Chemical Compatibility	123
C. Warranty	124
D. Verifying Measurement Tips	125
E. Environmental Compliance	126
F. Agency Certifications	127
G. Creating a Personalized Logo File	129
I. Restoring Factory Defaults	131

1 - Introduction

This instruction handbook is for use by the owner of the Remote Visual Inspection equipment and their personnel. Waygate Technologies remains the owner of the copyright on this instruction handbook. No part of this work covered by the copyrights herein may be translated, reproduced, stored in information retrieval systems, or transmitted, in any form or by any means graphic, electronic, or mechanical, including photocopying, recording, taping, or otherwise without the prior written permission of the publishers. Individual reproductions are allowed for business purposes only with the prior written consent of Waygate Technologies.

Should you have any questions concerning clarification of problems in connection with application, use, operation, specification of your Remote Visual Inspection equipment, please contact the following:

Technical Support Contact Information

Global Phone: 1-866-243-2638

Email: RemoteSupport@GE.com

NOTE: Contact information is subject to change. Please visit the Waygate Technologies website for the latest contact information.

NOTE: The terms XL Flex and XL Flex+, within this document, are used interchangeably and with the intent that both are applicable unless otherwise specified.

This equipment is manufactured under one or more of the following US patents:

- 4,980,769
- 6,468,201
- 6,590,470
- 6,959,432
- 7,170,677
- 7,262,797
- 7,564,626

1 - Introduction

About this Manual

This manual and the related equipment is intended for visual inspection technicians with a basic understanding of inspection principles and practices, and who are familiar with basic computer operations, but who may not have experience with a video borescope system.

The manual contains complete setup, operating, and maintenance instructions for the video borescope system. The manual also provides a product overview, step-by-step procedures, and reference information.

To ensure operator safety, please read and understand this manual prior to using the system.

For additional assistance, go to www.ge-mcs.com for a complete listing of contact information.

Standard Package

XL Flex
2-hour Li-Ion Battery
Wheeled- Storage Case
AC Adapter/Battery Charger

Documentation Thumbdrive
Quickstart Card
Optical Tip Storage Case
Inspection Manager

Optional Accessories

Spare 4 hour battery
VGA Video Cable
Insertion Tube Gripper
Insertion Tube Rigidizer
12V DC Power Adaptor
Handset Holder
Soft Case
Neck Strap
Sun Visor

Headset
Belt Clip
Keyboard
Optical Tips
Measurement Optical Tips
Mini-Magic Clamp Kit
Magic Arm Kit
Handset Mounting Hook

Optional Software

Menu Directed Inspection (MDI)
Stereo Measurement

1 - Introduction

Indicators, and Connectors

- 1 LCD Screen
- 2 USB2 Port
- 3 Integrated 2.5 mm Headset/Microphone Jack
- 4 Controls
- 5 2-hour Lithium Ion Battery
- 6 Battery Charge Indicator
- 7 AC Adaptor Input
- 8 USB Bay

1 - Introduction

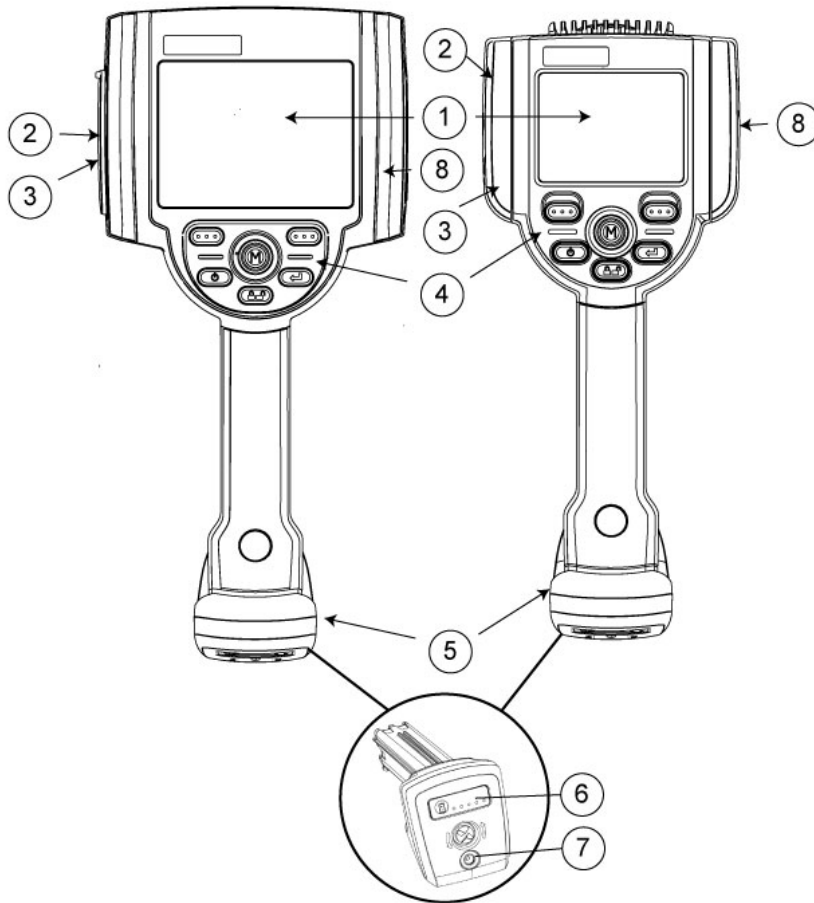

1 - Introduction

Controls

The following buttons control basic and advanced operation of the XL Flex+ VideoProbe.

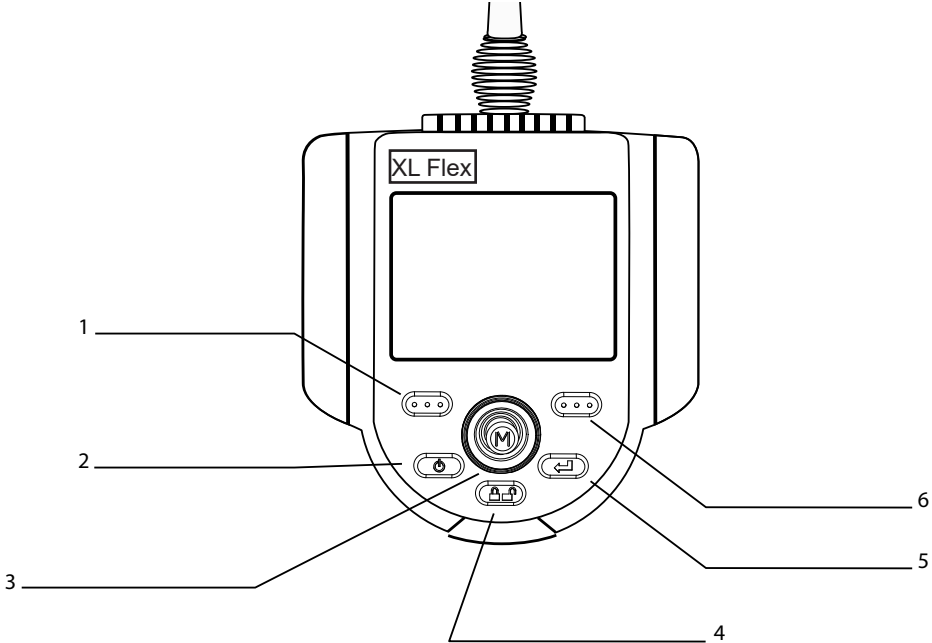

1 - Introduction

1 Left Soft Key

Activates screen command listed on system LCD. This key will most frequently return the user BACK one screen.



2 Power/Exit

Turns system power on/off. Also used to exit menus, return to live/frozen video and disable image control features.

3 Joystick

Controls articulation. Press to activate the Live Main Menu, Recalled Image Menu, and Freeze Frame Menu. Push the joystick left/right/up/down to navigate menus and sub-menus.

4 Steering Control

Press and release to keep bending neck locked in place after the joystick is released. A  lock will appear on the LCD when enabled. Press and release again to unlock the steering control. The  lock will disappear from LCD when disabled. Also, press and hold to engage HOME function to straighten bending neck. A blinking  Home icon will appear on the LCD when enabled. This icon will disappear when finished.

5 Freeze/Enter

Freezes the image on-screen. Also acts as enter key for selecting options.

6 Right Soft Key

Activates screen command listed on system LCD. This key will most frequently serve to SELECT active menu choices. This key will also provide an alternative method to access the LIVE MAIN MENU. Press and hold the  right soft key labeled GOTO for ~ 3 seconds.

2 - Safety Information

Note: Before using or servicing the system, read and understand the following safety information.

Symbols and Terms

The following symbols appear *on the product*:



See accompanying documentation.

General Warnings

The following warning statements apply to use of the system in general. Warning statements that apply specifically to particular procedures appear in the corresponding sections of the manual.



Do not allow the conductive insertion tube, system or its working tools to come in direct contact with any voltage or current source. Prevent all contact with live electrical conductors or terminals. Damage to the equipment and/or electrical shock to the operator may result.



Do not use this system in explosive environments



USE PROPERLY. Using any piece of this equipment in a manner not specified by the manufacturer may impair the product's ability to protect the user from harm.

2 - Safety Information



General Cautions

The following caution statements apply to use of the XL Flex device in general. Caution statements that apply specifically to particular procedures appear in the corresponding sections of the manual.

HANDLE PROBE CAREFULLY. Keep the insertion tube away from sharp objects that might penetrate its outer sheath. Keep the whole insertion tube as straight as possible during operation; loops or bends anywhere in the tube decrease its ability to steer the probe tip. Avoid bending the insertion tube sharply.

Note: Always use the Home button to straighten the bending neck before withdrawing insertion tube from inspection area or putting probe away. Never pull, twist, or straighten the bending neck by hand; internal damage may result. At the first sign of damage, return the probe for repair.

Certain substances may damage the probe. For a list of substances that are safe for the probe, see “Chemical Compatibility” in the Appendix.

2 - Safety Information

Battery Warnings

Only use the battery (XLGOABATTA or XLGOABATTB) and power supply (XLGOACHGR or XLGOAAUTOC) specified for use with the XL Flex+ system.

Before use, thoroughly review the instructions in this manual for the battery and battery charger to fully understand the information contained in them, and observe the instructions during use.



WARNING

- Do not place the battery in fire or exceed the battery operating temperature.
- Do not pierce the battery with nails, strike the battery with a hammer, step on the battery, or otherwise subject it to strong impacts or shocks.
- Do not expose the battery to water or salt water, or allow the battery to get wet.
- Do not disassemble or modify the battery.



Battery Communication Error: If the XL Flex+ shows this error message on the display, please contact your nearest customer support center.

Using the battery outside its recommended operating range will result in degradation of the performance and service life. When storing the battery, be sure to remove it from the base unit.

Recommended temperature range for Li-ion battery operation.

Discharge (when using the instrument): : -20° C to 46° C

Recharging : 0° C to 40° C

Storage : -25° C to +60° C

2 - Safety Information

Remarque : avant l'utilisation ou l'entretien du système, vous devez lire et comprendre les informations de sécurité qui suivent.

Symboles et termes employés

Les symboles suivants sont apposés **sur le produit** :



Voir la documentation jointe.

Avertissements généraux

Les avertissements suivants s'appliquent à l'utilisation du système en général. Les avertissements qui s'appliquent spécifiquement à des procédures particulières sont indiqués dans les sections correspondantes de ce manuel.



Le système XL Flex+ et les outils de travail qui l'accompagnent ne doivent jamais entrer en contact direct avec une source de tension ou de courant. Évitez tout contact avec des conducteurs ou des bornes électriques sous tension. L'équipement risquerait d'être endommagé, ou l'opérateur de subir un choc électrique.



N'utilisez pas ce système dans un environnement à risque d'explosion.



UTILISER CORRECTEMENT. Si un élément de cet équipement est utilisé d'une manière non indiquée par le fabricant, l'utilisateur peut ne plus être protégé des risques de blessure.

2 - Safety Information



Mentions générales « Attention »

Les mentions « Attention » qui suivent s'appliquent à l'utilisation de l'appareil XL Flex+ en général. Les mentions « Attention » qui s'appliquent spécifiquement à des procédures particulières sont indiquées dans les sections correspondantes du manuel.

MANIPULER LA SONDE AVEC PRÉCAUTION. Maintenez la gaine de la sonde à l'écart d'objets pointus ou tranchants qui risqueraient de traverser son fourreau. Maintenez toute la gaine aussi droite que possible pendant l'utilisation : en cas de boucle ou de courbure, il est plus difficile de piloter le bout de la sonde. Évitez de trop courber la gaine.

Remarque : utilisez toujours le bouton de rangement pour redresser le béquillage avant de rétracter la gaine de la zone d'inspection ou de ranger la sonde. Ne manipulez jamais le béquillage à la main pour le tirer, le courber ou le redresser : vous risqueriez de l'endommager à l'intérieur. Envoyez la sonde en réparation au premier signe d'endommagement.

Certaines substances risquent d'endommager la sonde. Pour consulter la liste des substances sans danger pour la sonde, voir Compatibilité Chimique en annexe.

Avertissements liés à la batterie

Utilisez uniquement la batterie (XLGOABATTA or XLGOABATTB) et l'alimentation (XLGOACHGR or XLGOAAUTOC) spécifiées pour être utilisées avec le système XL Flex+.

Avant utilisation, lisez attentivement les instructions contenues dans ce manuel relatives à la batterie et au chargeur de batterie pour bien les comprendre, et respectez ces instructions pendant l'utilisation de l'appareil.



AVERTISSEMENT

- Ne jetez pas la batterie au feu et ne dépassez pas sa température de fonctionnement.
- Ne percez pas la batterie avec des clous, ne la frappez pas avec un marteau, ne marchez pas dessus et ne la soumettez pas à des

2 - Safety Information

- impacts ou des chocs violents.
- N'exposez pas la batterie à l'eau douce ou salée, et évitez de la mouiller.
- Ne désassemblez pas la batterie et ne la modifiez pas.

 Erreur de communication de la batterie. Veuillez contacter le Service clientèle au numéro +1 866 243 2638.

L'utilisation de la batterie en dehors de la plage de fonctionnement recommandée entraînerait une dégradation de ses performances et de sa longévité. Lorsque vous stockez la batterie, veillez à la retirer de sa base.

Plage de température recommandée pour le fonctionnement de la batterie Lithium-Ion.

Décharge (à l'utilisation de l'appareil) : -20°C à +46°C Recharge , 0°C à +40°C Stockage, -25°C à +60°C

3 - Getting Started

System Removal

Gently remove the insertion tube from the internal storage reel and lift the handset from the storage case.

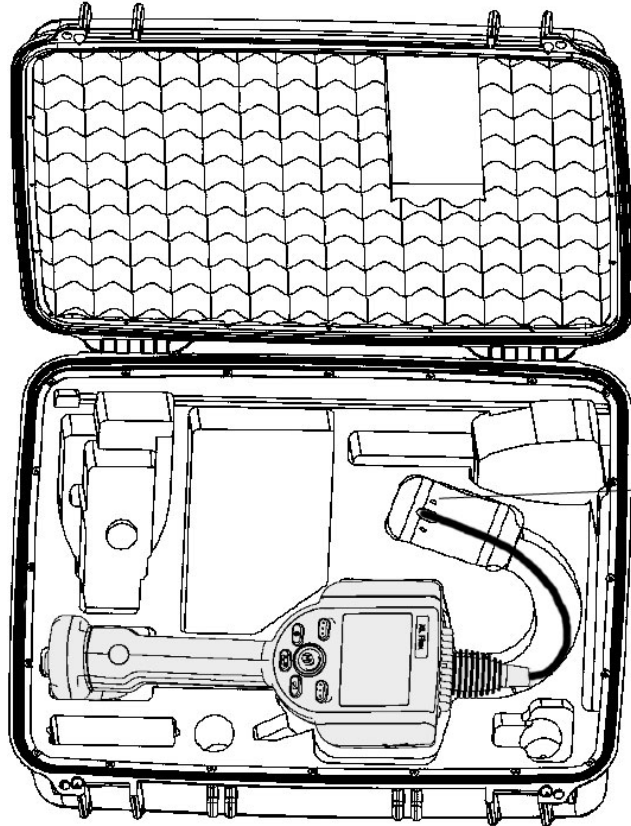

3 - Getting Started

System Power On

Press and hold the  Power/Exit key until unit turns on. The buttons and Liquid Crystal Display (LCD) will light and begin the power-up sequence. After approximately 30 seconds, select the desired language. The system screen will display live video and screen prompts. The system is now ready for use.

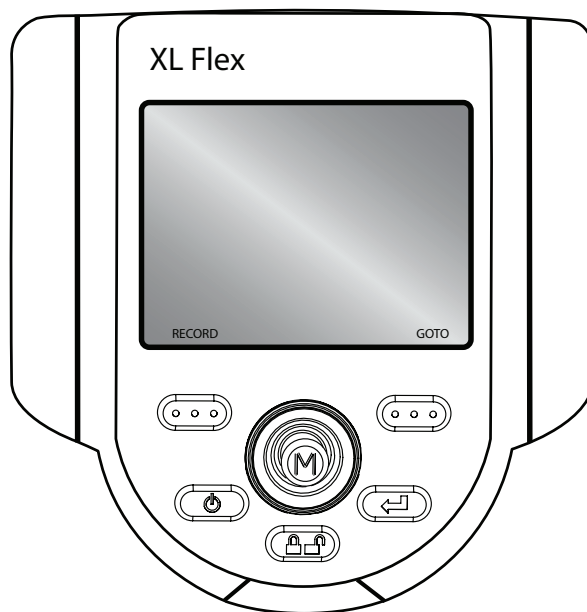

Note: All batteries are shipped with a partial charge. Batteries should be fully charged prior to use.

3 - Getting Started

System Power Off

Press and hold the  Power/Exit key until the “SYSTEM SHUTTING DOWN” message appears. Key illumination and LED probe lights will go out when system is completely powered down.

System Storage

Place the tip of the insertion tube into the orange funnel and gently feed into storage reel. Place the XL Flex+ handset into the designated foam cutout. LCD screen should face up.

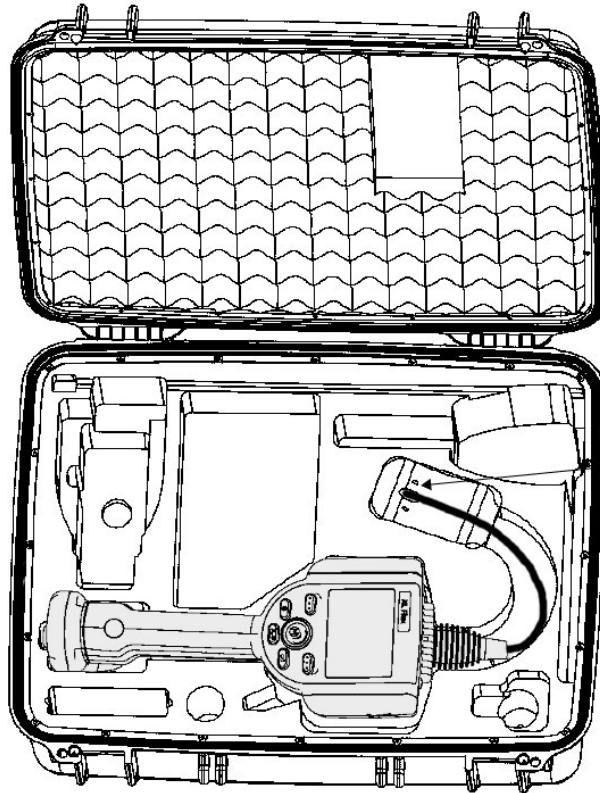

3 - Getting Started

Mounting Accessories

Assemble the optional mounting accessories by screwing together the mini magic clamp, swivel ball, and handset holder.

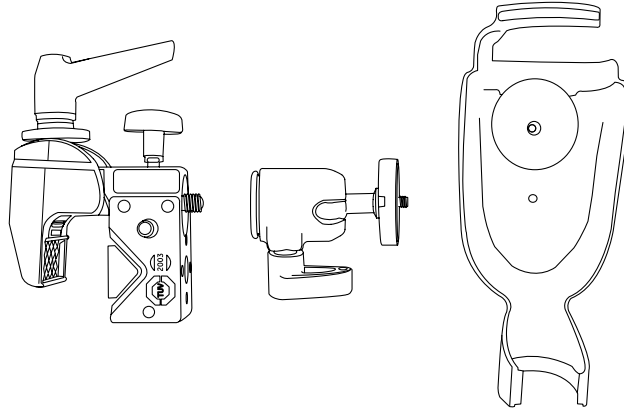

Secure the XL Flex+ mini magic clamp and place the XL Flex+ system in the handset holder.

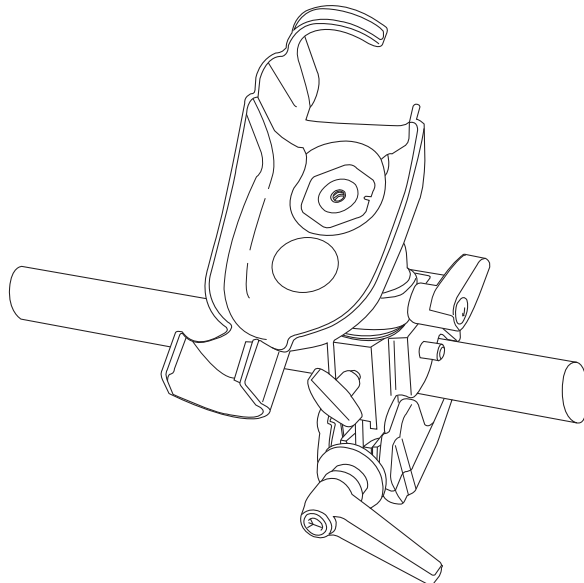

3 - Getting Started

Battery

Installing Battery

Insert the battery into the handset. The battery is installed properly when the latching mechanism is engaged.

Note: Do not force the battery into the handset, as damage may occur. The battery is keyed and may only be installed in the proper orientation.

Removing Battery

For batteries with the removal tab, using your hand, turn the tab counterclockwise to release the battery.

Note: Do not use a tool to remove the battery.

For batteries with the locking screw, using a standard screwdriver or coin, turn the locking screw counterclockwise and release the battery.

Note: Do not remove battery while system is operating.

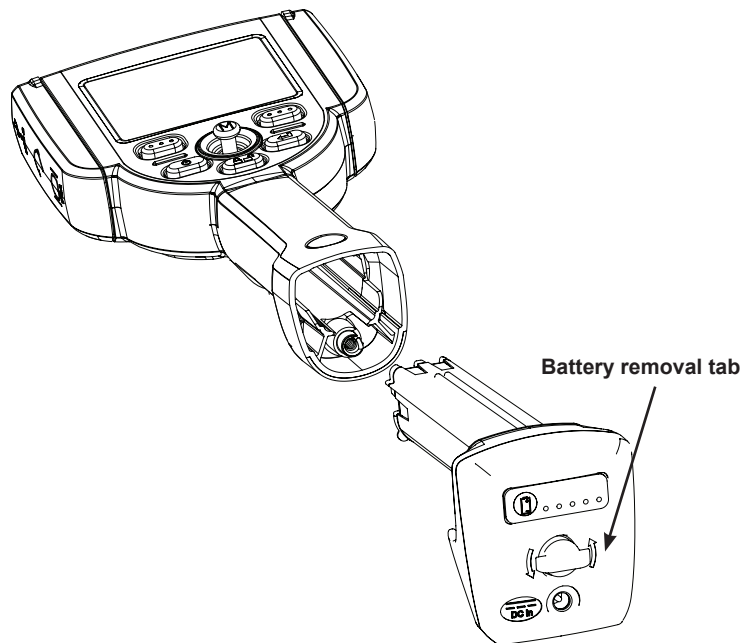

3 - Getting Started

Battery Charge Level

Check the battery charge by pressing the battery symbol on the front of the battery. Each light represents approximately 20% of the battery charge capacity.

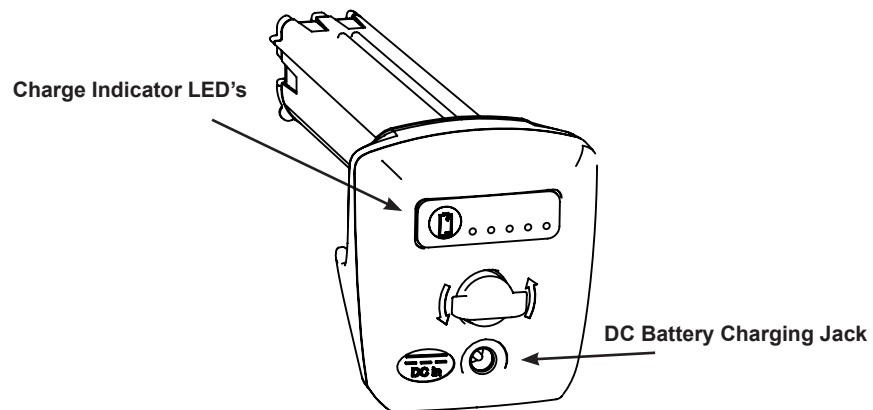

Charging Battery

Plug the included AC to DC power adaptor into a suitable AC power source and connect the DC output of the battery charger into the XL Flex+ battery. The LED battery lights will illuminate according to the amount of charge attained. The system may operate while charging.

The battery may also be charged while disconnected from the system.

Note: When the battery is fully charged, the LED battery lights will turn off.

Note: Battery run time approximately equals battery charge time; therefore, a four hour battery will take approximately four hours to charge.

3 - Getting Started

Keyboard Support

To use an external, USB keyboard, plug the approved device into one of the two USB ports.

For a list of approved keyboards, contact your sales representative or customer support.

The function keys on the keyboard act as the keys on the XL Flex+:

F1: Menu Function on Joystick

F2: Left Soft Key 

F3: Power/Exit Key 

F4: Steer & Stay Key 

F5: Enter Key 



F6: Right Soft Key 

Note: Keyboards only support the top level functions and will not support the press and hold functions such as video recording.

3 - Getting Started

Saving Images and Video

Still Images

To capture a still image, compose the picture and press and release  Freeze/Enter. Press the  right soft key with SAVE on the LCD above to save to the default location.

Alternately, from live video, press and hold  Freeze/Enter to quick-save.

Video

To record live video, press and hold the  left soft key labeled RECORD on the LCD above. A red record symbol will appear in the upper right hand corner. When the video is stopped, it will automatically save to the default location.

Note: See measurement section for instructions on saving images for future remeasurement on the XL Flex+ or a PC.

3 - Getting Started

Optical Tips

Optical tips are attached to the camera head using a double thread. This prevents unintended departures of optical tips from the probe. Each optical tip provides a unique depth of field (DOF), field of view (FOV) and direction of view (DOV). A complete list of available tips is provided in the Appendix.

Optical Tip Removal

1. Grasp the head of the probe with one hand and gently loosen the tip counterclockwise with the other hand. The tip has cleared the first set of threads when it spins freely.
2. Gently pull the tip away from the probe and continue loosening counterclockwise until the tip is free from the second set of threads.

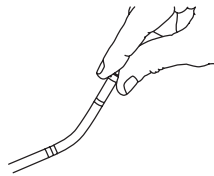

Optical Tip Installation

1. Ensure the optical tip is clean. Clean if necessary (See Cleaning Optical Tips).
2. Grasp the head of the probe with one hand and gently turn the tip clockwise with the other hand. The tip has cleared the first set of threads when it spins freely and then seats with gentle force applied.
3. Gently push the tip onto the probe and continue turning clockwise on the second set of threads until the tip is attached finger tight. Do not over tighten. Pull gently on the tip to ensure proper attachment to the probe.

NOTE: Never use tools or excessive force to install or remove an optical tip.

3 - Getting Started

Tip Tool Proper Use (4.0 mm only)

Removing Tips

1. Apply empty tip tool to probe head.
2. Apply pressure while turning in the counter-clockwise position.
3. When tip tool spins freely, gently pull up while twisting in the counter-clockwise position to release the second set of threads.
4. Remove tip tool and tip will be within.



Applying Tips

1. Apply tip tool containing appropriate tip to probe head.
2. Apply pressure while turning in the clockwise position.
3. When tip tool spins freely, gently push down while twisting in the clockwise position to engage the second set of threads.
4. Pull gently on tip tool to ensure proper attachment.
5. Remove tip tool and tip will be attached to probe head.

NOTE: Never use excessive force to install or remove an optical tip.

4 - Common Tasks

GO TO Menu

Many common operating tasks are available in the GOTO menu. This menu is available by pressing the  right soft key labeled GOTO during live video mode. To exit any menu, press  Power/Exit.

GO TO > File Manager

To enter the file manager, navigate to FILE MANAGER with the joystick and select with the  right soft key labeled SELECT.

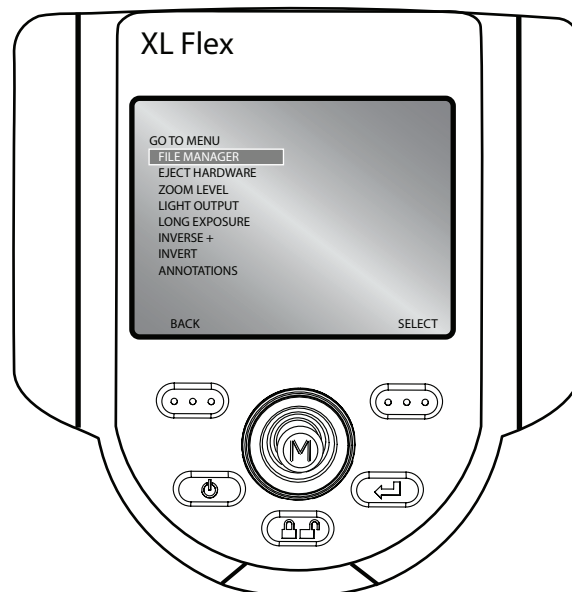

4 - Common Tasks

GO TO > Eject Drive

To eject USB thumb drives before removal, use the joystick to navigate to the right of EJECT HARDWARE and select the appropriate drive using the right soft key labeled SELECT.

Note: Always use EJECT HARDWARE before removing a USB thumb drive to prevent loss of data.

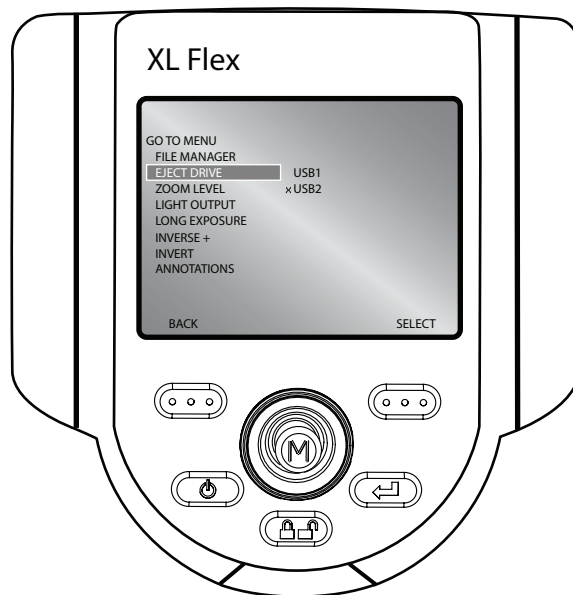

4 - Common Tasks

GO TO > Zoom Level

An image can be zoomed from 1 (normal view) to 5 (5 times zoomed). Navigate to the right of ZOOM LEVEL and use the joystick to adjust the zoom level. Zoom can be turned off in live video mode by pressing  Power/Exit.

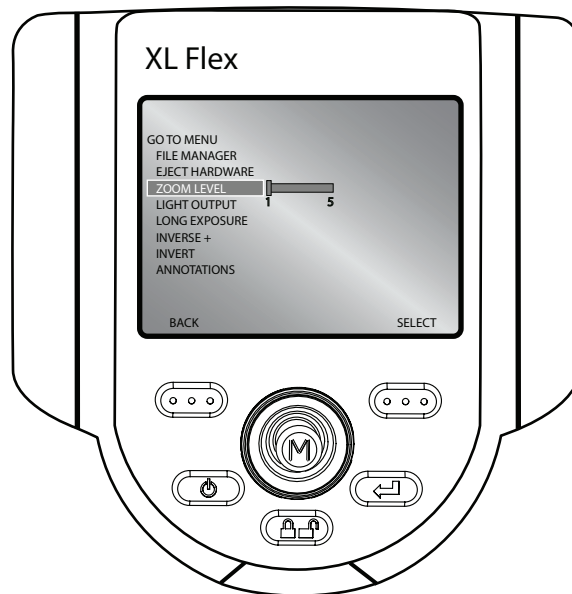

4 - Common Tasks

GO TO > Light Output

To turn the camera light source On or Off, navigate to the right of LIGHT OUTPUT and select ON or OFF.

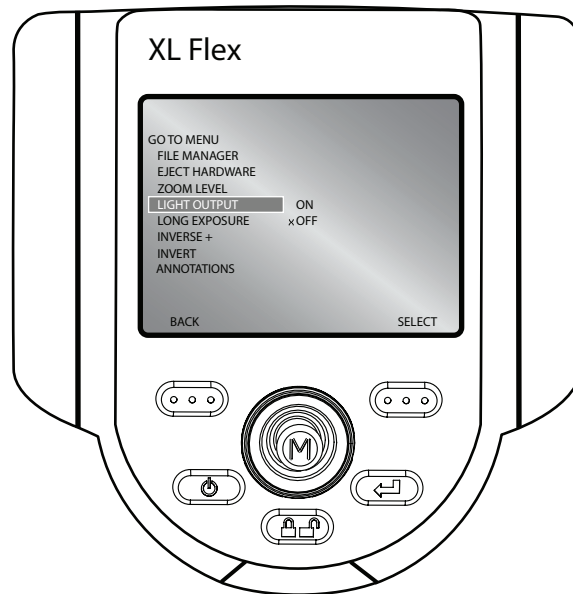

Note: Pressing the  Freeze Frame key is a convenient way to temporarily turn off the light output and is ideal for changing optical tips and conserving battery charge.

4 - Common Tasks

GO TO > Long Exposure

The XL Flex+ system can brighten the image by varying the exposure time. Keep the probe tip as still as possible when capturing an image with long exposure to minimize the risk of blurring.

Select LONG EXPOSURE to choose manual exposure, automatic long exposure, or to turn long exposure off. Long Exposure may be turned off in live video mode by pressing the  Power/Exit key.

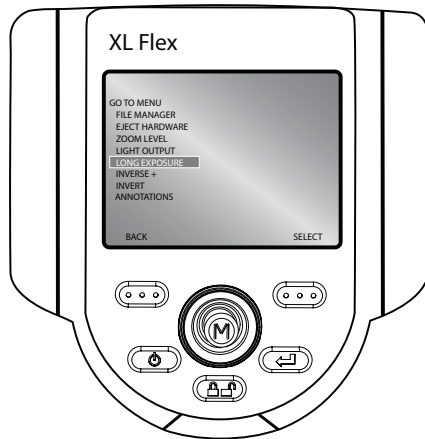

After selecting Long Exposure, the following options will be available:

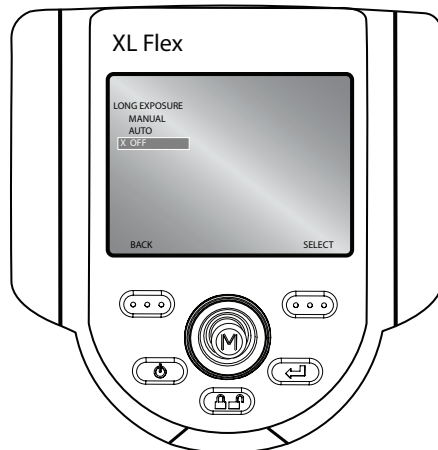

4 - Common Tasks

GO TO > Inverse +

Inverse + reverses the brightness similar to a photographic negative. It enhances the image contrast, making subtle details more visible. Inverse + may be turned off in live video mode by pressing the  Power/Exit key.

To activate or deactivate, navigate to INVERSE + and choose ON or OFF.

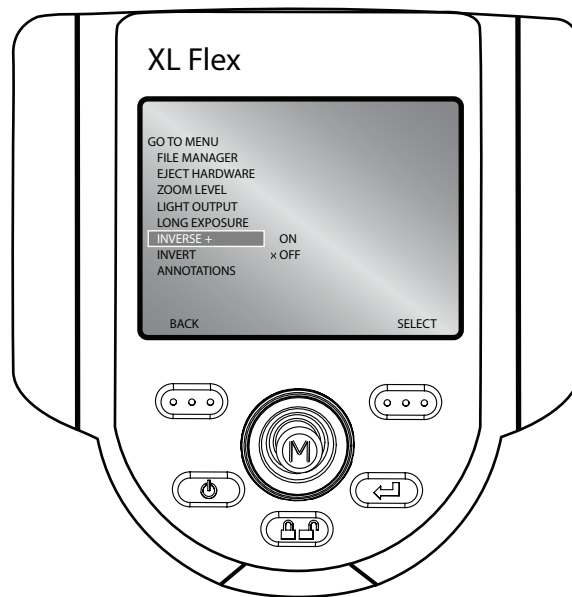

4 - Common Tasks

GO TO > Invert

The invert function flips an image horizontally. To activate or deactivate, navigate to INVERT and choose ON or OFF. Invert may be turned off in live video mode by pressing the  Power/Exit key.

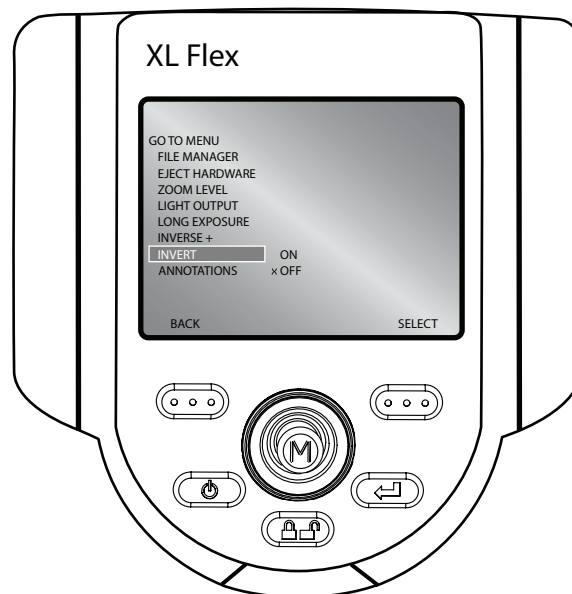

Note: Invert is typically used while a side view tip is installed in order to compensate for the inversion caused by this tip.

4 - Common Tasks

GO TO > Annotations

When Annotations have already been added to the image, user can quickly remove them by choosing ANNOTATIONS > DELETE ALL.

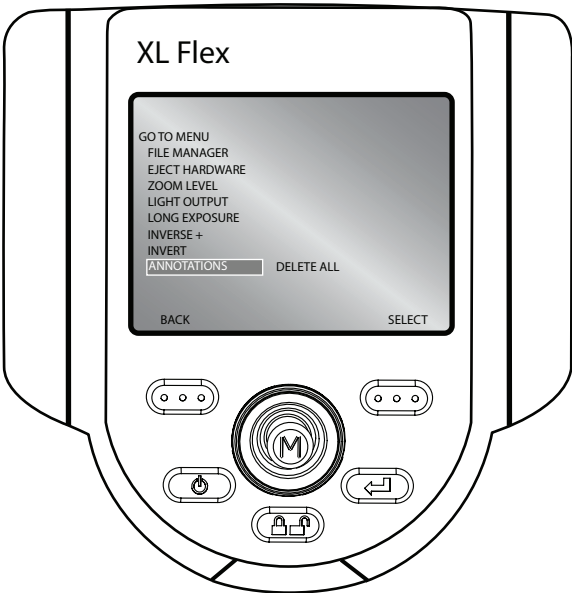

4 - Common Tasks

Live Main Menu

To activate the LIVE MAIN MENU, press and release the joystick. To exit any menu, press  Power/Exit.

An alternative method to access the LIVE MAIN MENU is a press and hold of the  right soft key labeled GOTO for ~3 seconds.

Live Main Menu > Light Output

To turn the LED optical light on/off, use the joystick to choose LIGHT OUTPUT and select ON or OFF.

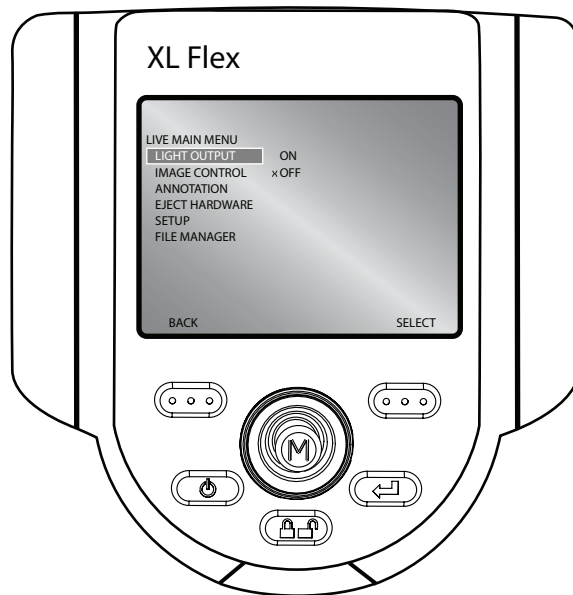

Note: Pressing the  Freeze Frame key is a convenient way to temporarily turn off the light output and is ideal for changing optical tips and conserving battery charge.

4 - Common Tasks

Live Main Menu > Image Control

From the LIVE MAIN MENU, select IMAGE CONTROL. The changes made to the Image Controls take effect immediately.

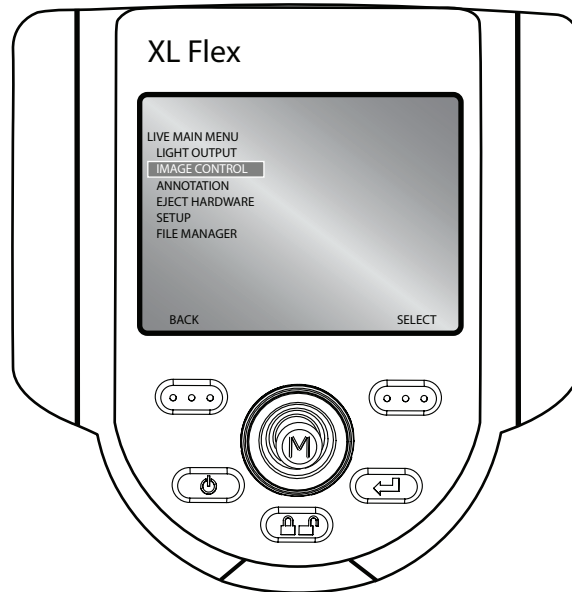

The following options are then available:

- Image Brightness
- Zoom Level
- Long Exposure
- Split Screen
- Single View
- Inverse +
- Invert

Note: By pressing the  power/exit key twice, any image control features will be turned off and returned to factory default settings.

4 - Common Tasks

Live Main Menu > Image Control > Image Brightness

Navigate to IMAGE BRIGHTNESS from the IMAGE CONTROL Menu and use the joystick to adjust the image brightness.

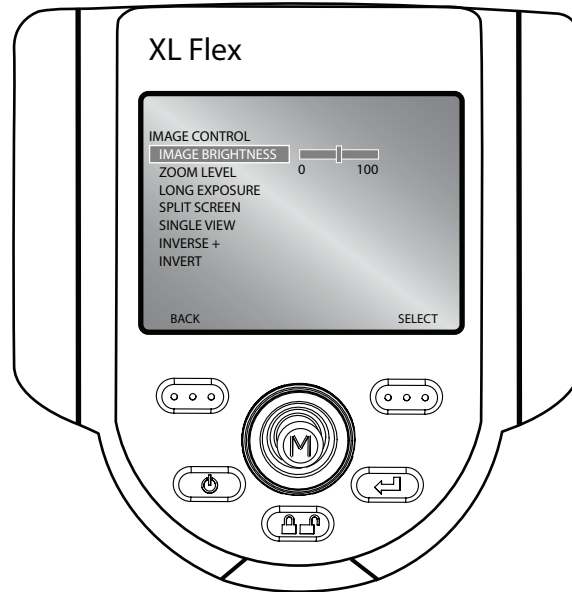

4 - Common Tasks

Live Main Menu > Image Control > Zoom Level

Navigate to ZOOM LEVEL from the IMAGE CONTROL Menu and use the joystick to adjust the zoom level. Digital zoom levels from 1x to 5x may be selected.



4 - Common Tasks

Live Main Menu > Image Control > Long Exposure

The XL Flex+ system can brighten the image by varying the exposure time. Keep the probe tip as still as possible when capturing an image with long exposure to minimize the risk of blurring.

Select LONG EXPOSURE to choose manual exposure, automatic long exposure, or to turn long exposure off. Long Exposure may be turned off in live video mode by pressing the  Power/Exit key.



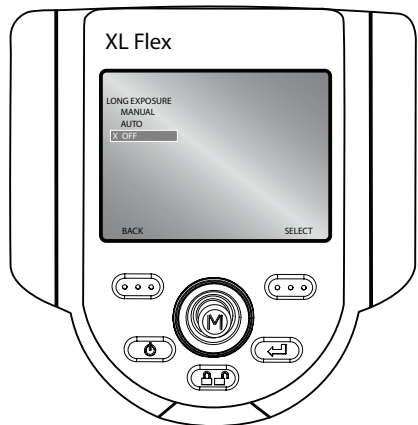

After selecting LONG EXPOSURE, the following options will be available:



4 - Common Tasks

Live Main Menu > Image Control > Split Screen

From a live, frozen, or recalled image, press the joystick to access the LIVE MAIN MENU, FREEZE FRAME MENU or RECALLED IMAGE MENU. Navigate to SPLIT SCREEN and press the  right soft key to select. Choose the area of screen to view by moving the joystick left or right and using the  right soft key to select. The left image is frozen and the right image is live.

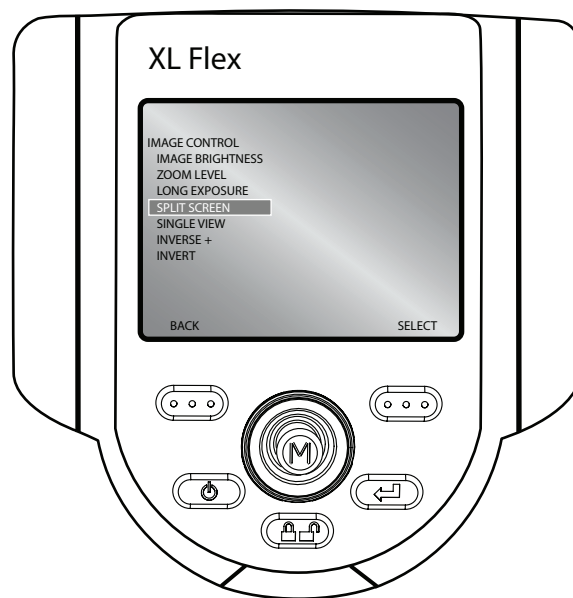

4 - Common Tasks

Live Main Menu > Image Control > Single View

While navigating the probe with a stereo tip attached, single view temporarily eliminates the second image.

Navigate to SINGLE VIEW from the IMAGE CONTROL MENU and select ON or OFF. Pressing the  Power/Exit key from live video will disable Single View.

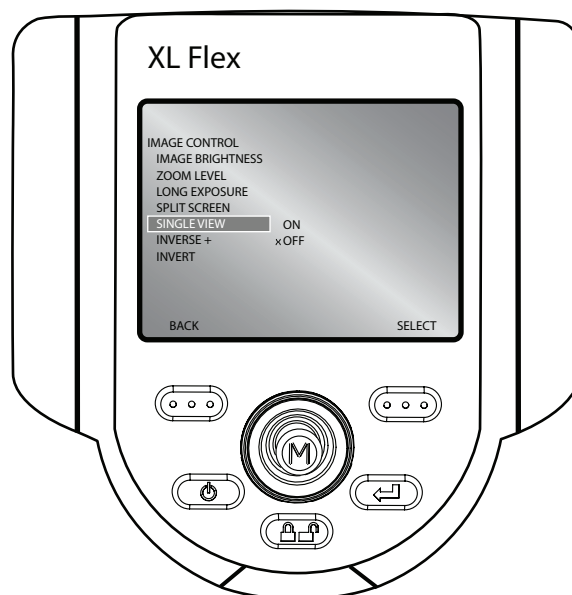

4 - Common Tasks

Live Main Menu > Image Control > Inverse +

Inverse + reverses the brightness like a photographic negative. It enhances the image contrast, making subtle details more visible.

To alter the contrast of an image, select INVERSE + from the IMAGE CONTROL MENU and select ON or OFF.

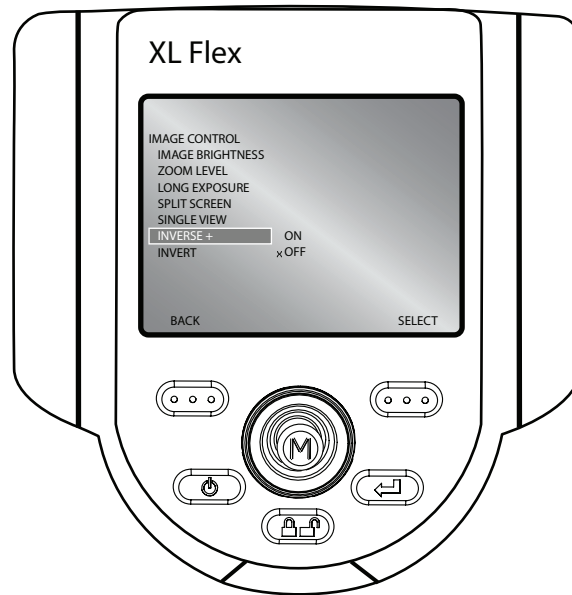

4 - Common Tasks

Live Main Menu > Image Control > Invert

The invert function flips an image horizontally. To activate or deactivate Invert, navigate to INVERT from the IMAGE CONTROL MENU and select ON or OFF.

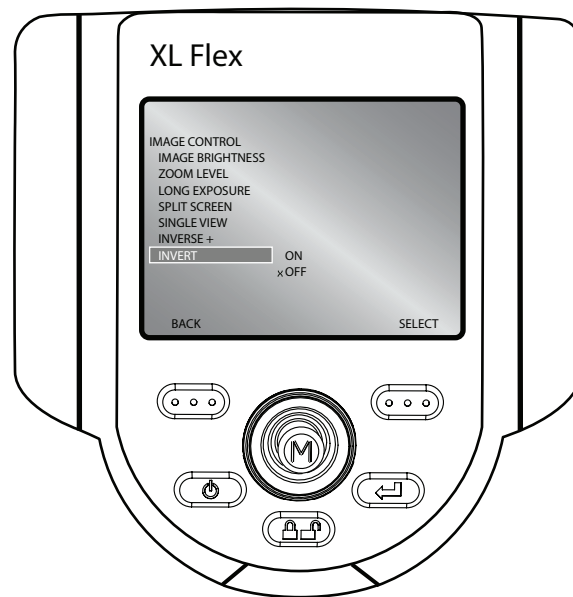

Note: This feature is most useful when using Sideview Optical Tips.

4 - Common Tasks

Live Main Menu > Annotation

Annotating an XL Flex+ image means adding text or arrows to describe or point out areas of interest: cracks, defects, etc. Annotation may be used on live, frozen, and recalled images.

To alter the annotation settings, press the joystick to activate the LIVE MAIN MENU and select ANNOTATION.



Note: There is a maximum of 3 lines of text/arrows per annotation.

Note: See the Freeze Frame Menu to enable Audio Annotation

4 - Common Tasks

Live Main Menu > Annotation > Text

To add, edit, or clear text on a specific image, select TEXT from the ANNOTATION menu.

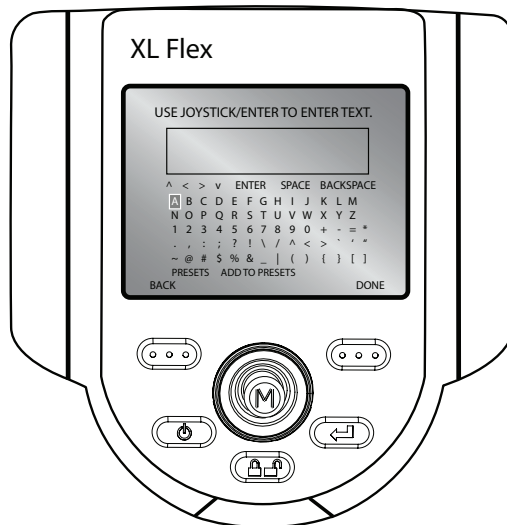
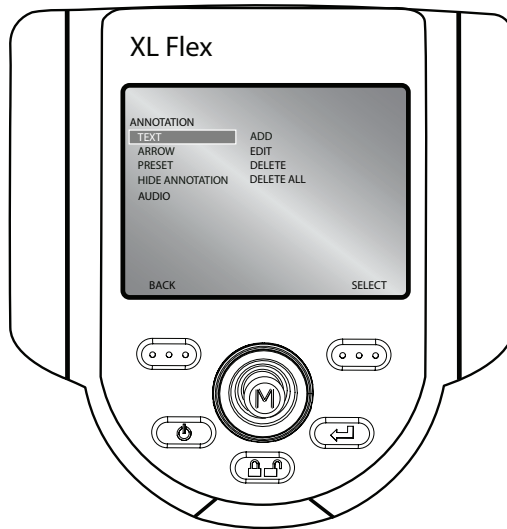

Note: Maximum number of text annotation characters is 50.

4 - Common Tasks

Live Main Menu > Annotation

Input Method Editors

The XL Flex+ supports text entry with advanced input methods for Simplified Chinese (Pinyin) and Japanese (Hiragana to Katakana/Kanji). To utilize these input methods the user must have an external keyboard connected to the VideoProbe. These input methods default as active when either Chinese or Japanese are selected as the system language. To return to an on-screen keyboard that does not utilize an input method, toggle the button that reads "Input Method -/O"

Chinese

The XL Flex+ supports the Pinyin text entry method. For each word or phrase that you wish to enter, please perform the following:

1. Using the external keyboard, type the Pinyin representation of the character to be entered.
2. Use the numbers on the external keyboard to select the desired character from the candidate list.
3. Press the enter key to confirm the selection.

Japanese

The XL Flex+ supports a text entry method that converts Hiragana to Katakana and Kanji characters. For each word or phrase you wish to enter, please perform the following:

1. Using the external keyboard, enter the Hiragana that make up the word being entered.
2. When all of the Hiragana that make up the word is entered, press the space bar on the external keyboard to get a candidate list of characters.
3. Use the numbers on the keyboard to select the desired word.
4. Press the enter key to confirm selection.

Note: If the desired word is not shown in the candidate list, press Page Up / Page Down on the keyboard to cycle through more options.

Note: A maximum of 6 Hiragana may be entered for each word or phrase for Japanese text entry.

4 - Common Tasks

Live Main Menu > Annotation > Arrow

To add, edit or clear arrow on a specific image, select ARROW from the ANNOTATION menu.

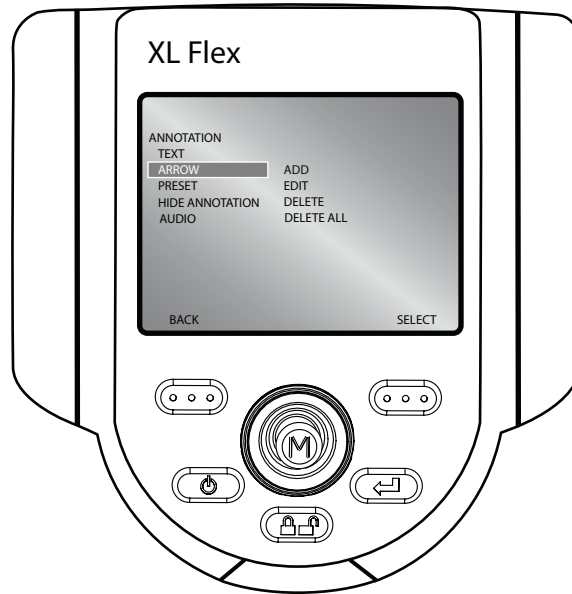

Note: Maximum number of arrow annotations is 25.

4 - Common Tasks

Live Main Menu > Annotation > Preset

To create, recall or delete a preset annotation that will display throughout an inspection, choose PRESET from the ANNOTATION menu. To load or export a file containing presets, choose PRESET from the ANNOTATION menu.

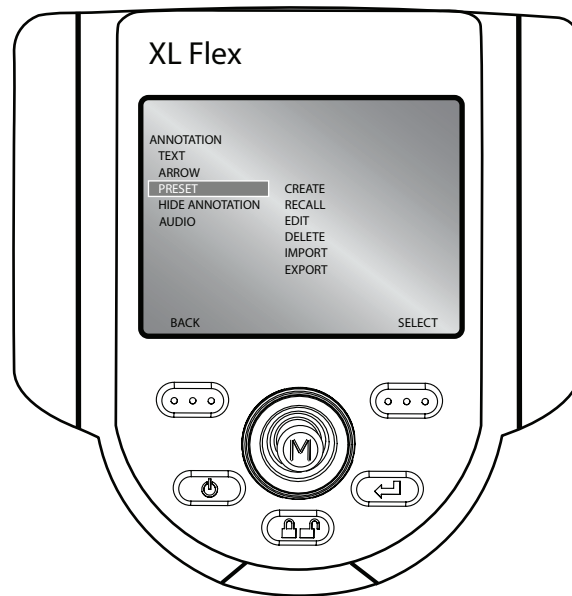

Note:

- Maximum number of preset annotations is 100
- Preset files must be line-delimited .txt files
- The maximum preset length is calculated by character width (approximately 28 characters).

4 - Common Tasks

Live Main Menu > Annotation > Loading a Preset

To load a file containing multiple presets onto the XL Flex+, a file may be created on a PC. This file must conform to the following:

- Line-delimited (each preset must be on a separate line)
- File Type - .txt
- Encoding - UTF8
- Recommended Program - Microsoft™ Notepad

At the time of saving the document, select .txt as the file type and UTF-8 as the encoding. See example below.

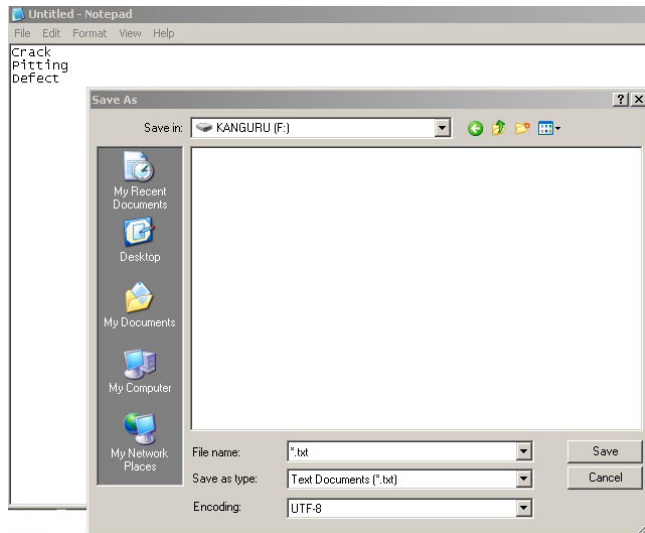

Loading the File

1. Save the Preset.txt file onto external media(CF Card, USB ThumbDrive, etc).
2. Insert the external media into XL Flex+.
3. Access the LIVE MAIN MENU by pressing joystick.
4. Select ANNOTATION.
5. Select PRESET > LOAD.
6. Locate the file that you have created.

4 - Common Tasks

Live Main Menu > Annotation > Hide Annotation

To hide or unhide an annotation, select HIDE ANNOTATION from the ANNOTATION menu followed by ON or OFF.

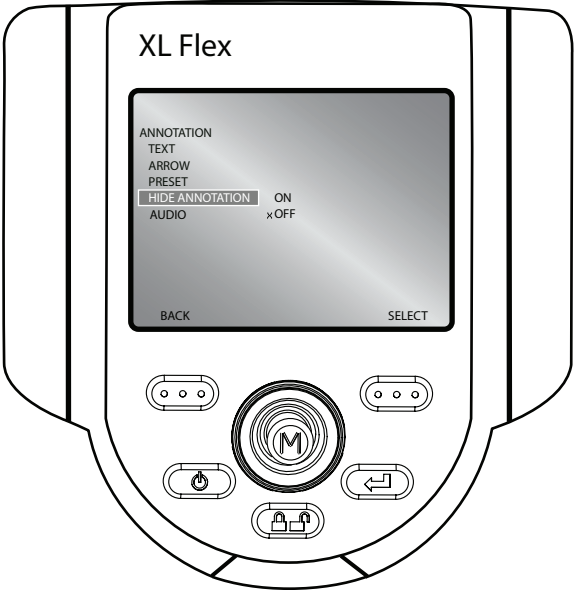

4 - Common Tasks

Live Main Menu > Eject Hardware

To eject USB thumb drives before removal, use the joystick to navigate to the right of EJECT HARDWARE and select the appropriate drive using the right soft key labeled SELECT.

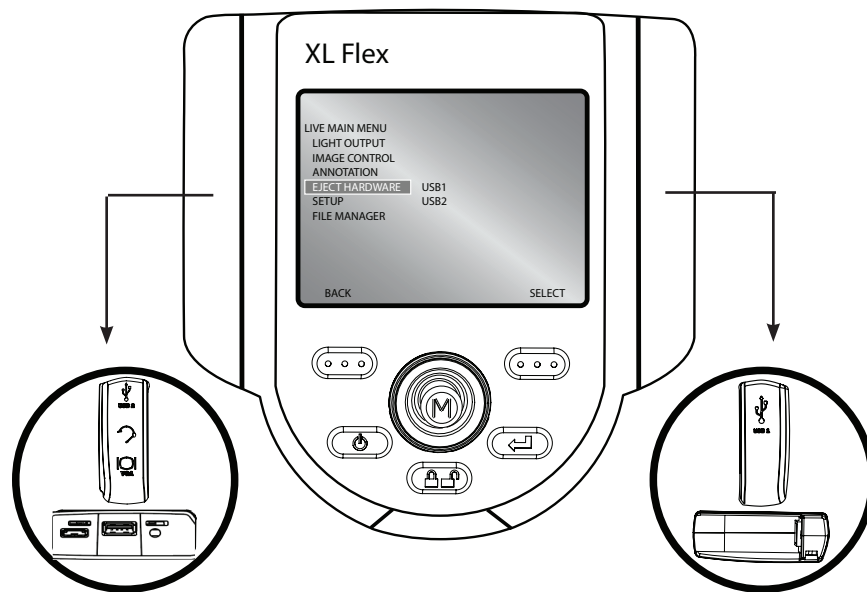

Note: Always use EJECT HARDWARE before removing a USB thumbdrive to prevent loss of data.

4 - Common Tasks

Live Main Menu > Setup

To change default settings, select SETUP. For more information see SYSTEM SETUP Section in the Operation Chapter.

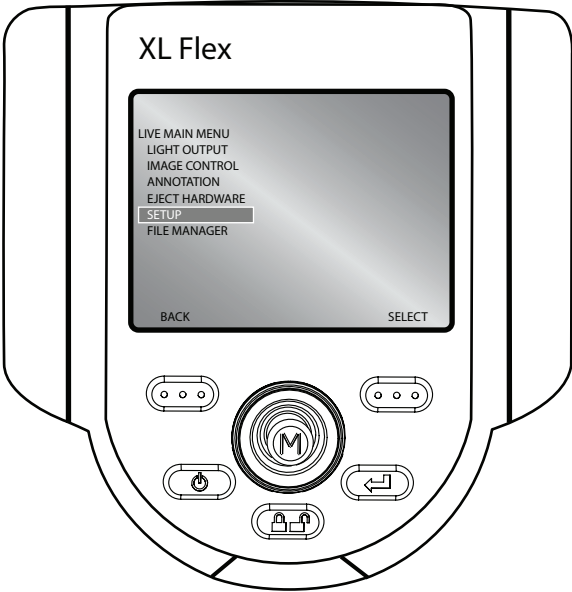

5 - Operation

Live Main Menu > Setup

The System Setup Menu accesses the default settings. To exit any menu, press  Power/Exit.

Live Main Menu > Setup > Screen/Display Setup

To alter the display setup, press the joystick to activate the LIVE MAIN MENU. Select SETUP followed by SCREEN/DISPLAY.



5 - Operation

Live Main Menu > Setup > Screen/Display > Battery Icon

To enable and disable the battery icon, select BATTERY ICON followed by ON or OFF.

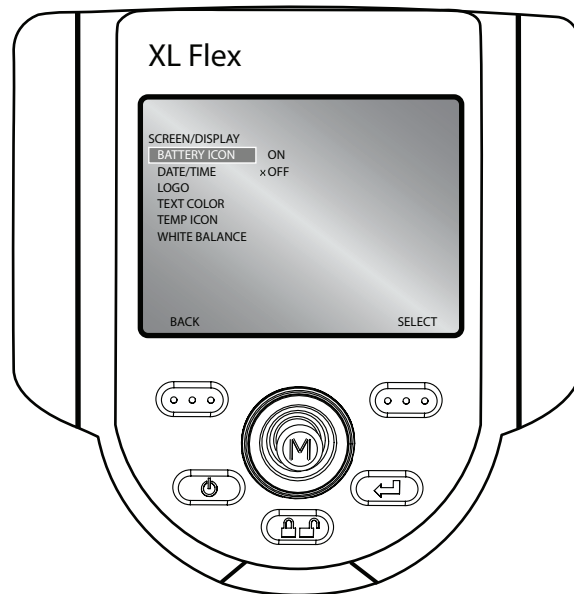

5 - Operation

Live Main Menu > Setup > Screen/Display > Date / Time

To enable or disable the date/time stamp, as well as set the date and time, select DATE/TIME from the SCREEN/DISPLAY menu.

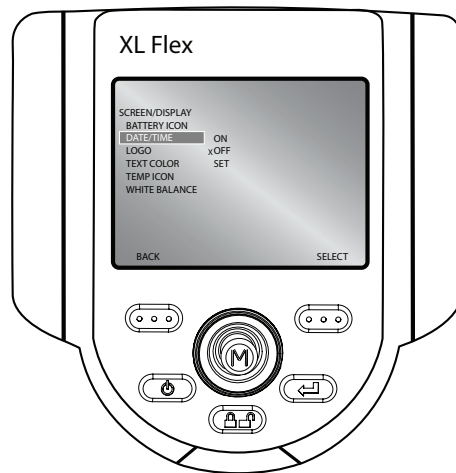

To change date format between MM/DD/YYYY and DD/MM/YYYY, select the Month, Day, Year format and move the joystick up or down to select preferred format. Select OK when finished.

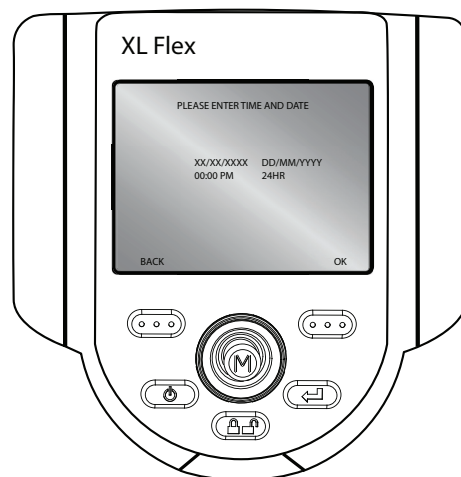

5 - Operation

Live Main Menu > Setup > Screen/Display > Logo

A logo may be added to the screen. The file name “logo.jpg” must be used. To load a logo, or to turn a logo on or off, select LOGO from the SCREEN/DISPLAY menu and select the desired option.

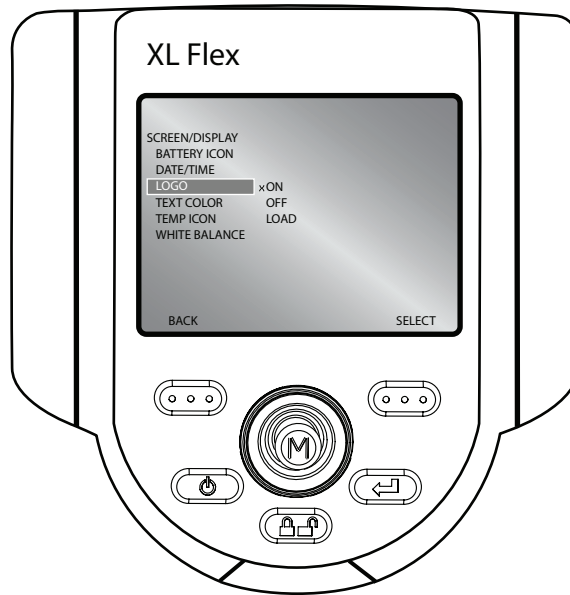

Note: See Appendix G for details on creating a logo file.

5 - Operation

Live Main Menu > Setup > Screen/Display > Text Color

The most legible text color will vary with the coloring and brightness of the image. To change the color of the text displayed over images, select TEXT COLOR followed by GREEN, BLACK, or WHITE.

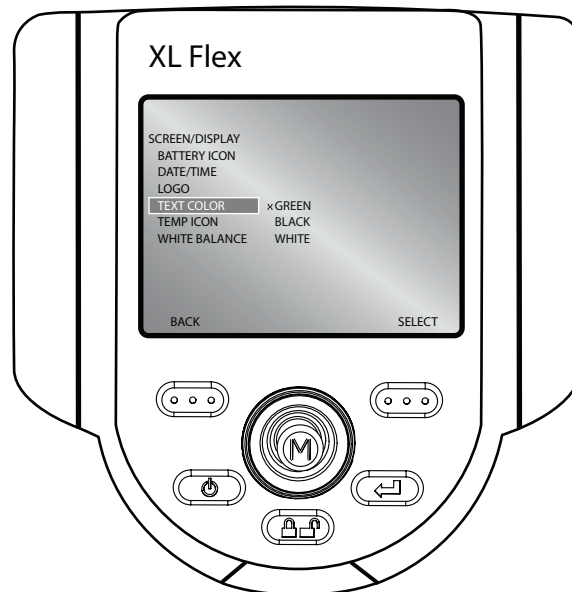

5 - Operation

Live Main Menu > Setup > Screen/Display > Temp Icon

To enable or disable the temperature icon, select TEMP ICON from the SCREEN/DISPLAY menu.

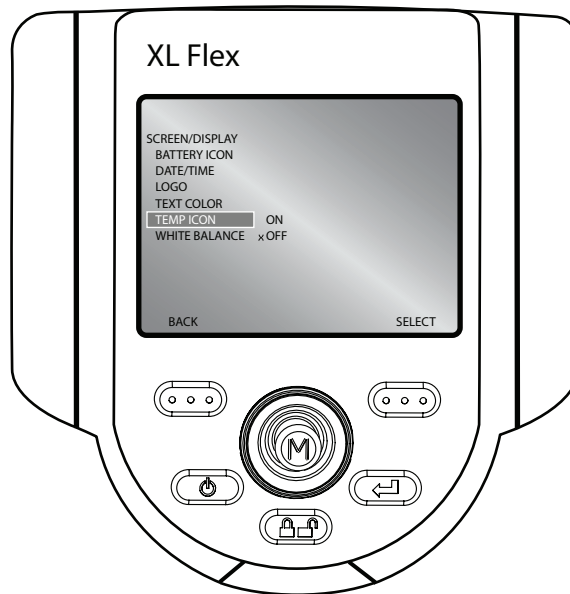

5 - Operation

Live Main Menu > Setup > Screen/Display > White Balance

White balance corrects color so white appears white despite any slight hues that may be present under varying lighting and ambient conditions.

To execute white balance, select WHITE BALANCE from the SCREEN/DISPLAY menu. Options are to set a custom white balance or use the default settings.

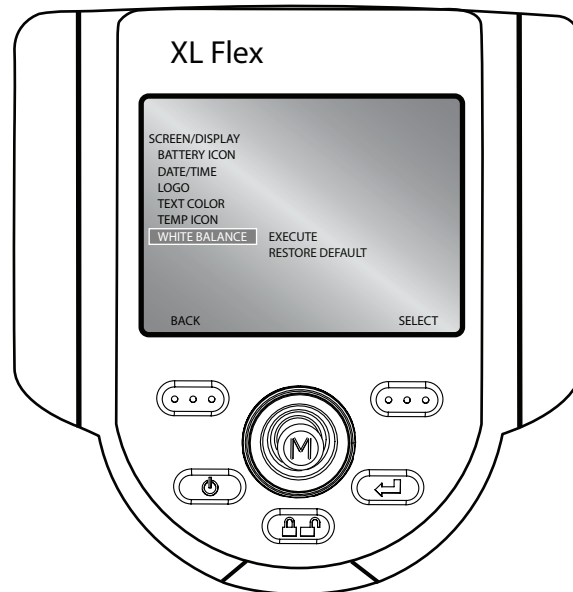

5 - Operation

Live Main Menu > Setup > Measurement Setup

To change MEASUREMENT SETUP defaults, press the joystick to activate the LIVE MAIN MENU. Select SETUP followed by MEASUREMENT SETUP.



5 - Operation

Live Main Menu > Setup > Measurement Setup > Stereo Tip Utilities

To access STEREO TIP UTILITIES, press the joystick to activate the LIVE MAIN MENU. Select SETUP followed by MEASUREMENT SETUP followed by STEREO TIP UTILITIES.



5 - Operation

Live Main Menu > Setup > Measurement Setup > Stereo Tip Utilities > Cal Info

To verify which stereo tip optics are calibrated to the probe, press the joystick to activate the LIVE MAIN MENU. Select SETUP followed by STEREO TIP UTILITIES followed by CAL INFO to view the tip optic serial numbers.



The ADD TIP menu feature allows stereo measurement tips to be added to the XL Flex+ by your local service center. TIPS MUST BE CALIBRATED AT WAYGATE TECHNOLOGIES SERVICE CENTER.

5 - Operation

Live Main Menu > Setup > Measurement Setup > Units

To change MEASUREMENT UNITS, press the joystick to activate the LIVE MAIN MENU. Select SETUP followed by MEASUREMENT, then MEASUREMENT UNITS followed by INCHES or MM.



5 - Operation

Live Main Menu > Setup > Measurement Setup > Accuracy Index

To enable or disable ACCURACY INDEX, press the joystick to activate the LIVE MAIN MENU. Select SETUP followed by MEASUREMENT SETUP, then ACCURACY INDEX.

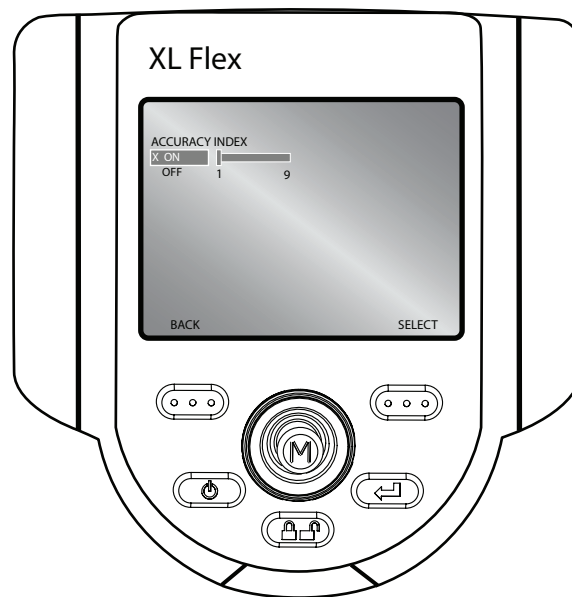

This feature allows the Accuracy Index to be shown on-screen during Stereo measurements.

5 - Operation

Live Main Menu > Setup > Measurement Setup > User Prompts

To enable or disable USER PROMPTS, press the joystick to activate the LIVE MAIN MENU. Select SETUP followed by MEASUREMENT SETUP, then USER PROMPTS.



This feature allows advanced users to disable user prompts when in measurement mode.

NOTE: Only a trained professional should turn off user prompts.

5 - Operation

Live Main Menu > Setup > Video Record Setup

To change video record defaults, press the joystick to activate the LIVE MAIN MENU. Select SETUP followed by VIDEO RECORD SETUP.

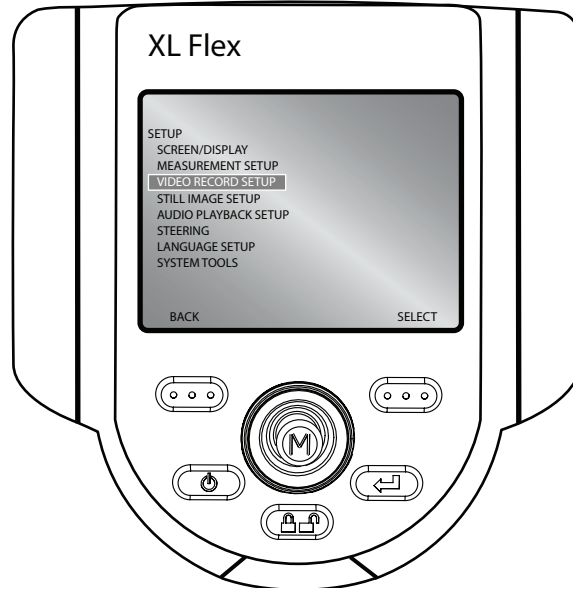

5 - Operation

Live Main Menu > Setup > Video Record Setup > Save Location

Select SAVE LOCATION from the VIDEO RECORD SETUP menu and navigate to the desired location.

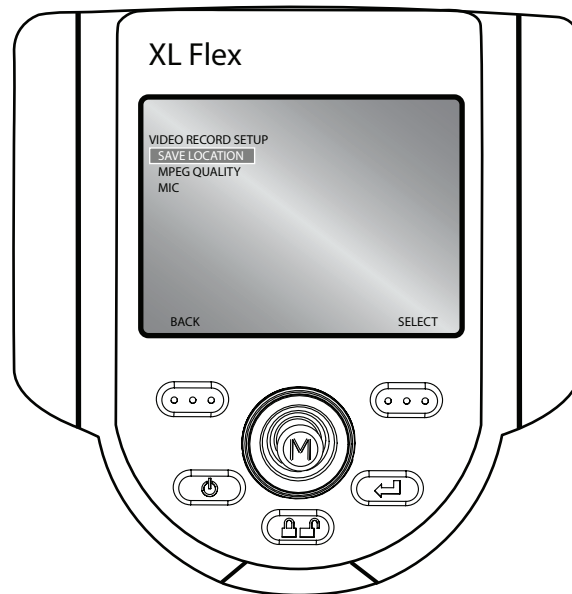

5 - Operation

Live Main Menu > Setup > Video Record Setup > MPEG Quality

To set the video quality, select MPEG QUALITY from the VIDEO RECORD SETUP menu followed by LOW or HIGH.

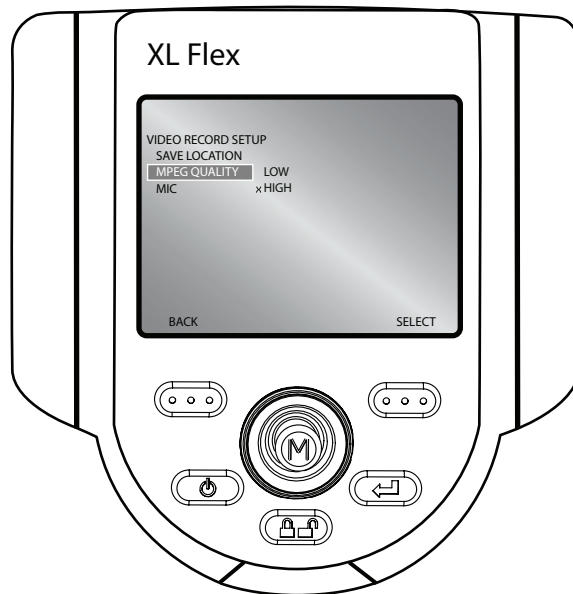

MPEG Quality	Recording Rate	16GB thumb drive ~minutes of video
MPEG-4 High	30MB/min	~266 minutes
MPEG-4 Low	15MB/min	~532 minutes

5 - Operation

Live Main Menu > Setup > Video Record Setup > MIC

To turn an external mic on or off, select MIC from the VIDEO RECORD SETUP menu followed by ON, MUTE, or DISABLED.

Note: The XL Flex+ does not have a built in mic.

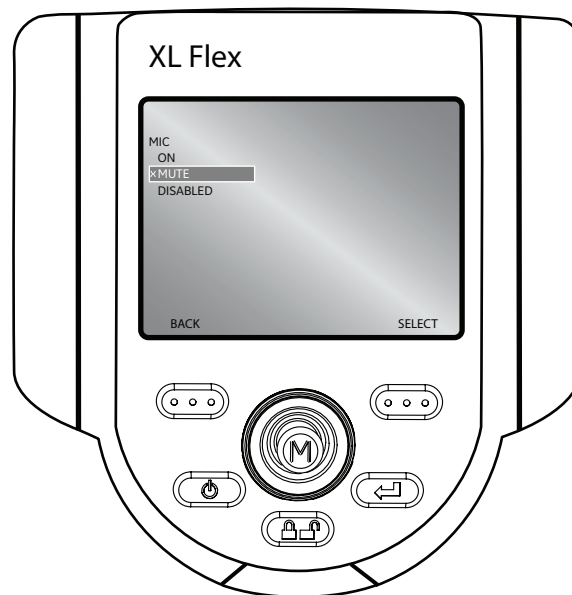

5 - Operation

Live Main Menu > Setup > Still Image Setup

To change still image defaults, press the joystick to activate the LIVE MAIN MENU. Select SETUP followed by STILL IMAGE SETUP.

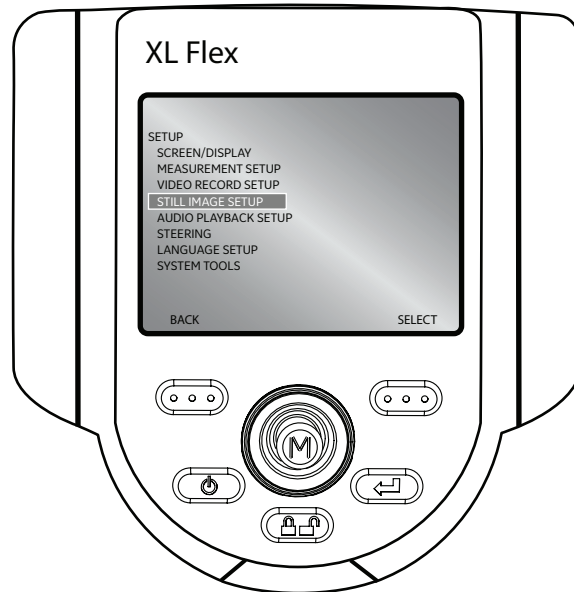

5 - Operation

Live Main Menu > Setup > Still Image Setup > Save Location

Select SAVE LOCATION from the STILL IMAGE SETUP menu and use the joystick to navigate to the desired location.

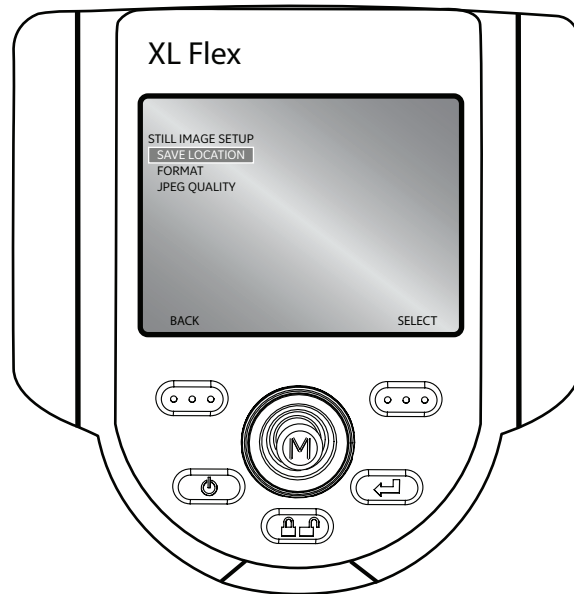

5 - Operation

Live Main Menu > Setup > Still Image Setup > Format

To choose the image format [Bitmap (BMP) or JPEG (JPG)], navigate to the right of FORMAT and select BMP or JPG.



Bitmap images are the highest quality images that can be saved; however, they are also the largest files size.

NOTE: Bitmap images are the recommended file format for saving images containing measurements.

5 - Operation

Live Main Menu > Setup > Still Image Setup > JPEG Quality

To choose JPEG quality, the user must first select JPEG image format. Once selected, navigate to the right of JPEG QUALITY and select LOW or HIGH.

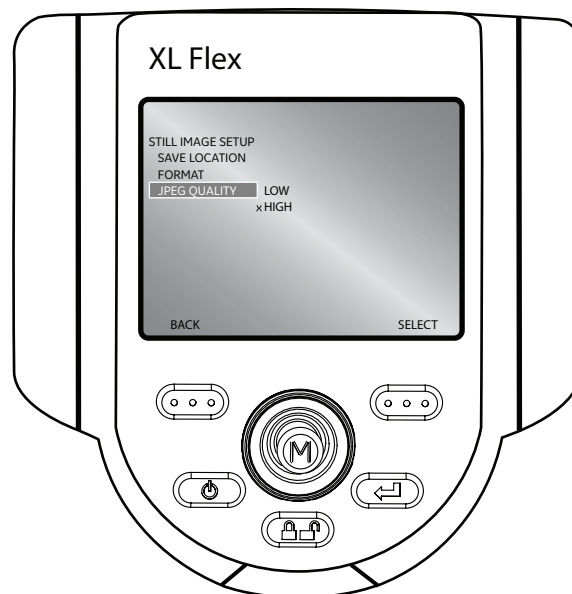

JPEG images are a compressed file format. They create smaller file sizes than bitmap images.

NOTE: JPEG low is NOT recommended for saving images containing measurements.

5 - Operation

Live Main Menu > Setup > Audio Playback Setup

To change audio defaults, press the joystick to activate the LIVE MAIN MENU. Select Setup followed by AUDIO PLAYBACK SETUP.

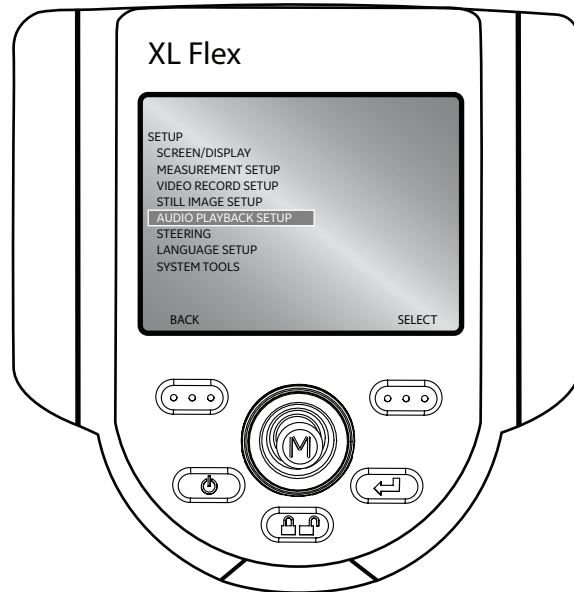

Note: To PLAY, RECORD OR DELETE AUDIO ANNOTATION, press the Joystick from a frozen image. Select ANNOTATION followed by AUDIO.

Note: XL Flex+ does not have a built in microphone, you must attach an external mic in order to record audio annotation.

5 - Operation

Live Main Menu > Setup > Audio Annotation Setup > Playback Volume

To set the playback volume, select PLAYBACK VOLUME from the AUDIO ANNOTATION SETUP menu. Use the joystick to control the volume from 0 to 10.



Note: XL Flex+ does not have a built in speaker, you must attach an external headset in order to playback audio annotation.

5 - Operation

Live Main Menu > Setup > Steering Setup > Steering

To manage probe articulation, select the steering increment. Options are *COARSE* or *FINE*.

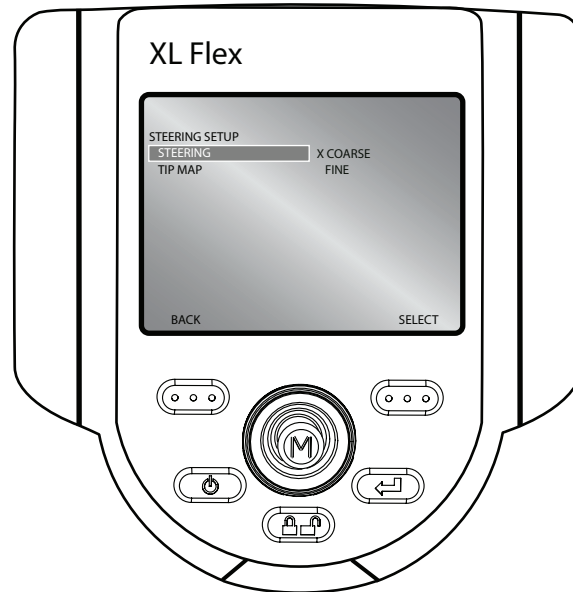

5 - Operation

Live Main Menu > Setup > Steering Setup > Tip Map

Tip Map is a grid that indicates probe-tip position. To turn Tip Map ON or OFF, select STEERING SETUP from the SETUP menu followed by TIP MAP.

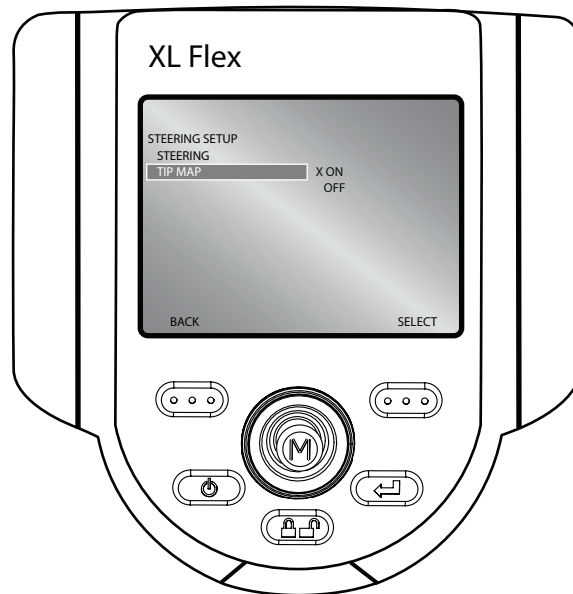

5 - Operation

Live Main Menu > Setup > Language Setup

To load or change the system language or external keyboard, select LANGUAGE SETUP from the SETUP menu followed by the appropriate language.



The following options are available:

- LOAD
- CHANGE
- KEYBOARD SETUP

5 - Operation

Live Main Menu > Setup > System Tools

To view system information or adjust power management, select SETUP from the LIVE MAIN MENU followed by SYSTEM TOOLS.

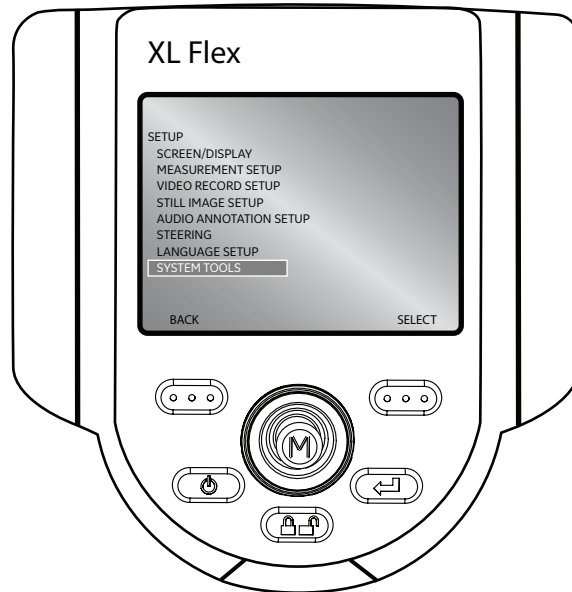

5 - Operation

Live Main Menu > Setup > System Tools > System Info

To view system information such as the software version or the amount of free disk space, select SYSTEM INFORMATION from the SYSTEM TOOLS menu.



5 - Operation

Live Main Menu > Setup > System Tools > Power Management

Power management enables a sleep mode / auto off to save battery power. To enable or disable power management, select POWER MANAGEMENT from the SYSTEM TOOLS menu followed by ON or OFF.

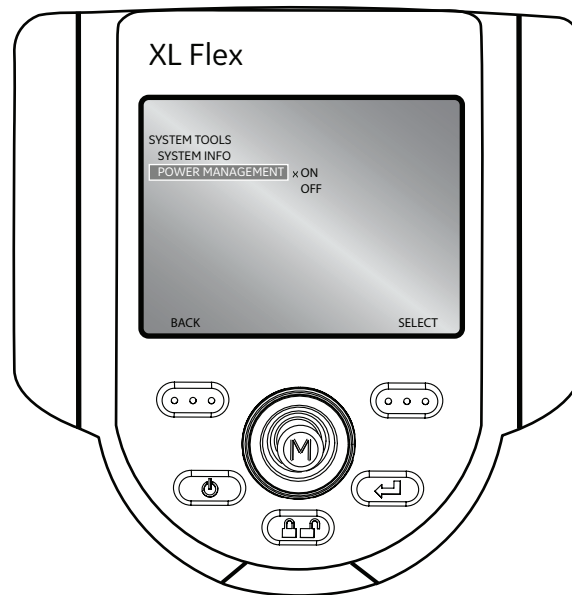

Sleep Mode

Occurs automatically under battery power if no buttons have been activated for 15 minutes. Sleep mode is indicated by the push button lights flashing in a rotating circle around the joystick.

Auto Off

If sleep mode is not interrupted by any button or joystick activation within 15 minutes the system will power off to conserve battery.

5 - Operation

Live Main Menu > File Manager

To manage files and folders on the XL Flex+ VideoProbe system, select FILE MANAGER with the joystick. For more details refer to the FILE MANAGEMENT section in the Operation Chapter.

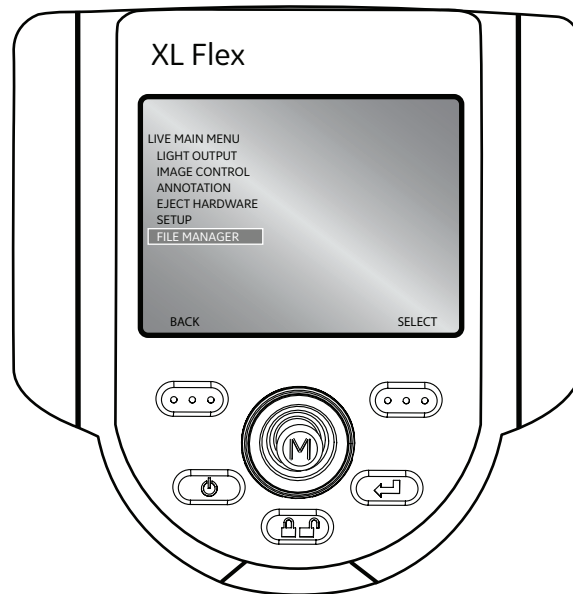



5 - Operation

Capturing Images and Video

Steering the VideoProbe

The joystick controls articulation (steering) of the probe tip. When viewing a live video image, move the joystick towards the desired inspection area.

Articulation Lock

To hold the bending neck in place while steering, press and release the  Steering Control key. A  lock icon will appear in the corner of the display to symbolize steer and stay is enabled. The probe will now stay in place when the joystick is released.

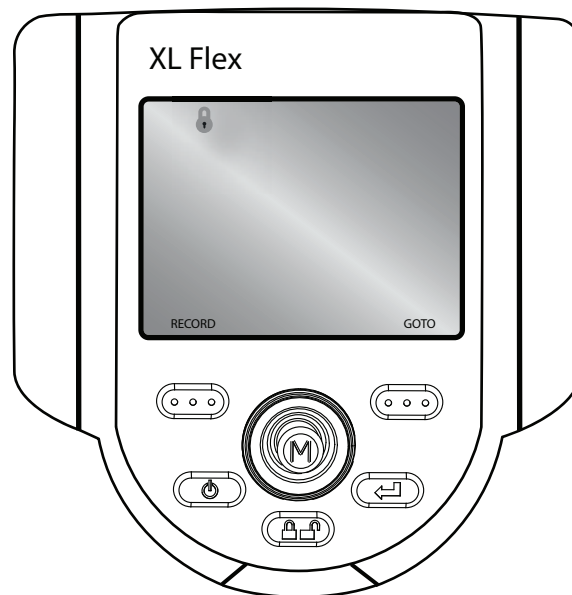

To unlock steering, press and release  Steering Control again. The  lock icon will disappear.



Note: While articulation lock is enabled, the XL Flex+ will steer in fine articulation mode.

5 - Operation

Articulation Home

Press and hold  to engage HOME function to straighten bending neck. A blinking  home icon will appear on LCD when enabled.

 HOME icon will disappear when system is finished.

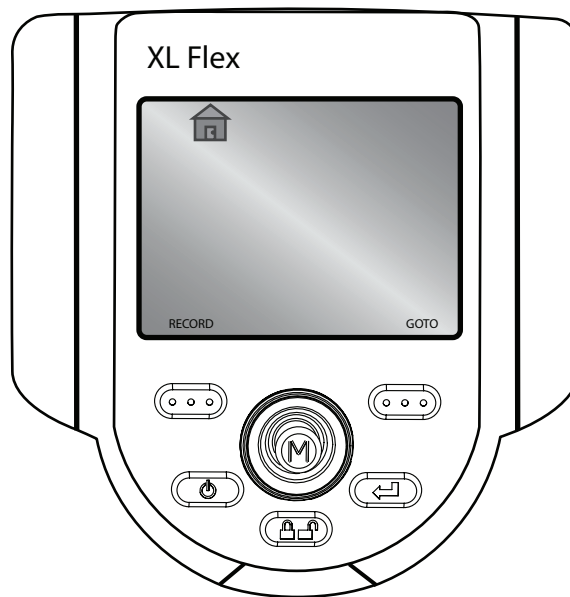

Note: It is recommended that a home operation is performed before withdrawing the camera from the asset being inspected, to avoid getting the camera stuck in the asset or damaging the XL Flex+.

5 - Operation

Freeze Frame

Once the inspection area is in view, the image must be frozen before it can be measured or saved. To freeze an image, press  Freeze/Enter. An “FF” will appear in the upper right corner of the display to symbolize that the image is frozen.

To disable Freeze Frame, press  Freeze/Enter again. The “FF” will disappear.

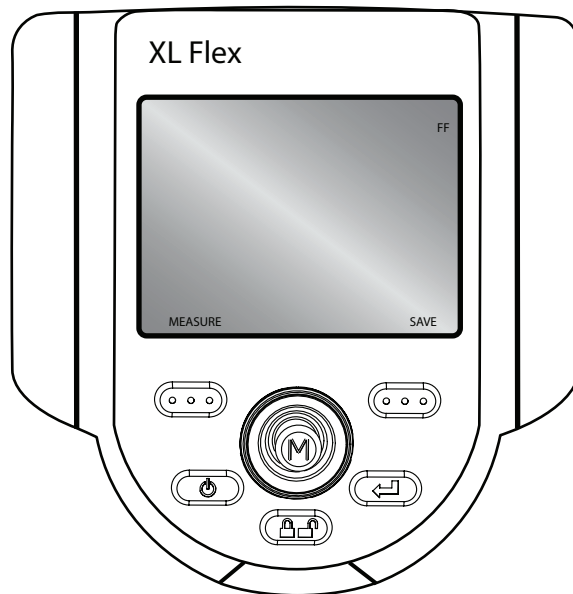

5 - Operation

Freeze Frame Menu

Once Freeze Frame is enabled, press the joystick to enter the FREEZE FRAME MENU.

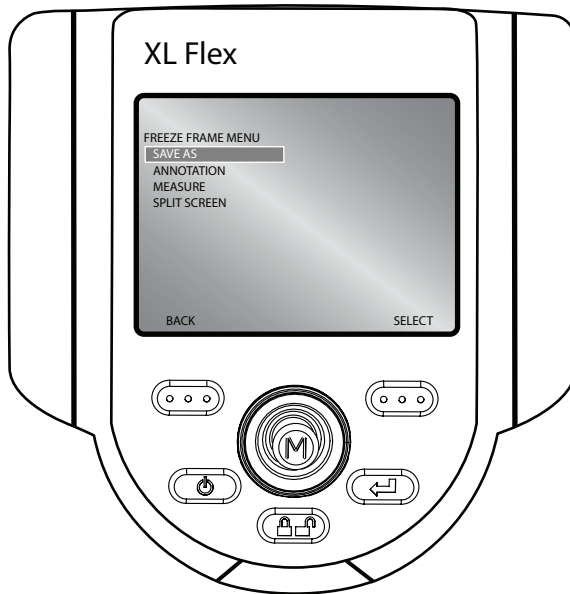

The following options are available:

- SAVE AS
- ANNOTATION
- MEASUREMENT
- SPLIT SCREEN

5 - Operation

Freeze Frame Menu > Annotation

To add, edit or delete an annotation, or to play, stop or pause an audio annotation, select ANNOTATION from the FREEZE FRAME MENU.

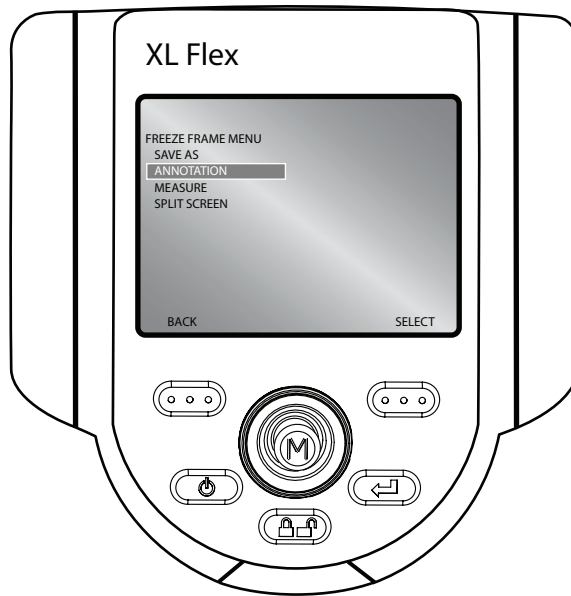



The following options are available:

- TEXT
- ARROW
- PRESET
- HIDE ANNOTATION
- AUDIO

5 - Operation

Still Image Capture and Playback

To save/capture a still image if freeze frame is enabled, press the  right soft key with SAVE on the LCD above to save to the default location. Alternately, press and hold  Freeze/Enter to auto-save.

Note: For further information see the “Save with Measurement” section.

Video Recording and Playback

To record live video, press the  left soft key labeled RECORD on the LCD above. A record symbol will appear in the upper right hand corner. When the video is stopped, it will automatically save to the default location.

To view recorded videos on a PC, use either QuickTime or VLC software. Both are included with the system, located on the documentation CD.



QuickTime

Still Image Capture During Video Recording

To capture a still image during video recording, pause the video using the  left soft key, press the  Freeze/Enter button to capture the image, press  right soft key to save the image, and press  Exit to resume video recording.

5 - Operation

File Manager

To access the FILE MANAGER, press the joystick to activate the LIVE MAIN MENU. Navigate to FILE MANAGER and select.

Recalling a File

To recall a file, select RECALL. Move the joystick to the right to locate the file(s) and use the  right soft key to select.

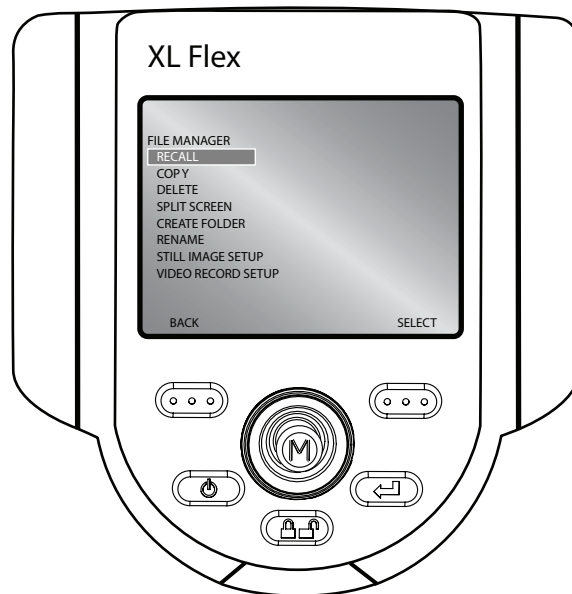

5 - Operation

Recalled Image Menu

After recalling an image, press the joystick to activate the RECALLED IMAGE MENU





The following options are available:

- SAVE AS
- MEASURE
- SPLIT SCREEN

5 - Operation

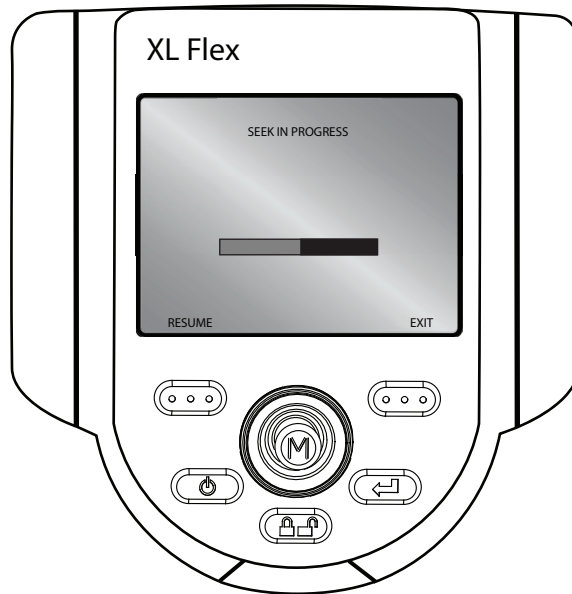

Video Playback Menu

To navigate a recalled video, either press the joystick left (rewind) or right (fast forward) or press the left  soft key to pause the video and then press the joystick left or right. If navigating a paused video, press the left  soft key to resume playback.



5 - Operation

Copying Files/Folders

To copy a file, select COPY. Move the joystick to the right to locate the file(s) and use the  right soft key to mark/unmark. Press  Freeze/Enter to copy.

Choose the destination for the copied file. Use the joystick to navigate to the desired folder. Press  Freeze/Enter to paste the copied file.

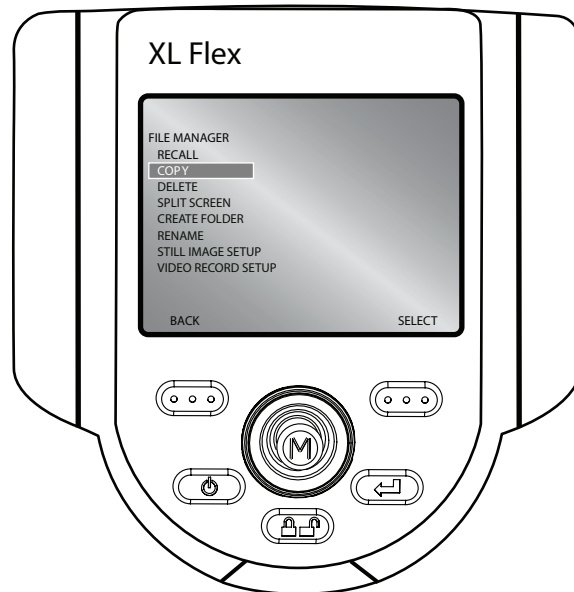

5 - Operation

Deleting Files/Folders

To delete a file, select DELETE FILE. Move the joystick to the right to locate the file(s) and select. Press  Freeze/Enter to delete.

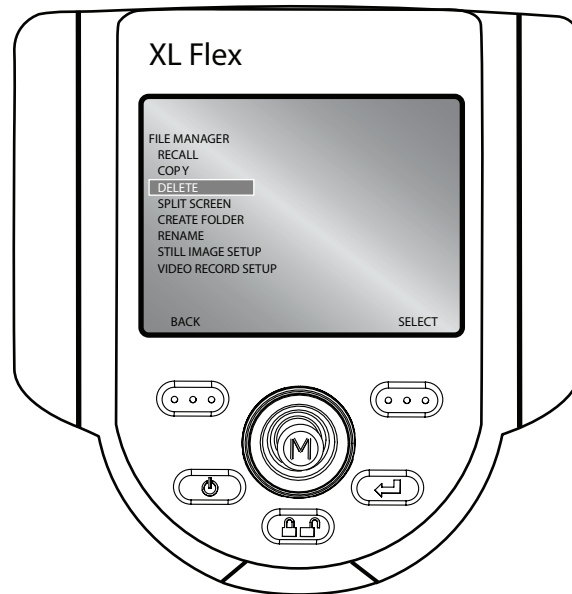

5 - Operation

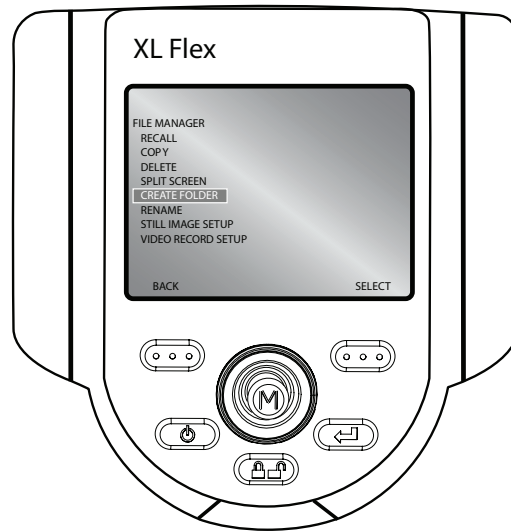

Creating a Folder

To create a folder, select CREATE FOLDER. Select the location of the folder. Use the joystick to highlight and  Freeze/Enter to select each letter. When done, press the  right soft key to save the folder name.



5 - Operation

Renaming Files/Folder

To rename a file, select RENAME. Navigate to the desired file/folder and use the  right soft key to select. Use the joystick to highlight and  Freeze/Enter to select each letter. When finished, press the  right soft key to save the file name.

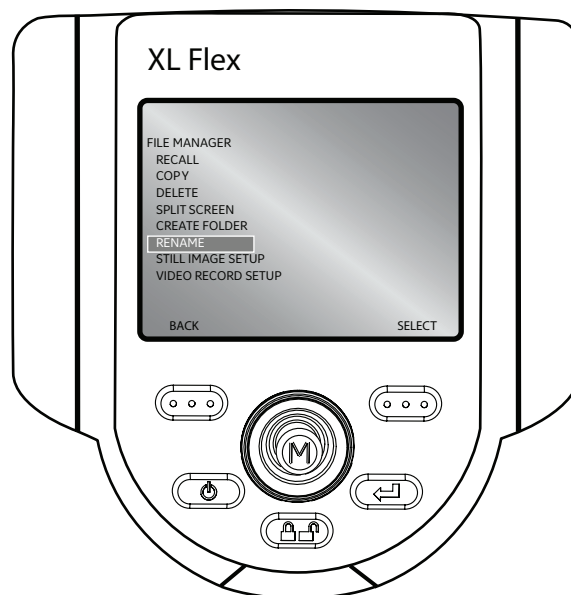

6 - Measurement

About Measurement

Measurement capability is enabled once measurement tips have been calibrated to the XL Flex+ system. Features and defects may be measured either before or after saving an image (if the image was saved in measurement mode). Up to five measurements can be saved per image.

Measurement results are valid only for measurements taken in air. For measurements taken in liquid, contact GE Sensing and Inspection Technologies.

A measurement accuracy verification block is supplied with the purchase of measurement tips. Perform a measurement on this verification block to check accuracy. See Appendix D for help with using the verification block.

All measurement images saved using the XL Flex+ system can be re-measured on a PC using Inspection Manager or iViewPC software.

Measurement File Formats

Measurement images, such as, JPEGs or bitmaps can be saved. These files can also be viewed including the measurement results, in most .BMP or .JPG viewing applications, such as Windows™ Paint. To learn how to change the file format, see **STILL IMAGE SETUP > FORMAT > JPEG QUALITY**.

NOTE: The .BMP file format is recommended for measurement image capture.



Measurement Optical Tips

StereoProbe® measurement tips are factory-calibrated for use with specific probes. Tips are matched to systems by the serial numbers identified on each optical tip. A label located in USB1 bay indicates which tips are calibrated to the probe.

To ensure that no mechanical damage has degraded tip accuracy, verify measurement tips each time they are used. See Verifying Measurement Tips in the Appendix.

6 - Measurement





Measurement Procedure

Attach a measurement optical tip, position the probe for maximum accuracy and freeze the image. Using the  left soft key, select Measurement. Choose the measurement tip and the type of measurement. Position the cursor and press  Freeze/Enter to save the cursor placement. Repeat with remaining cursor(s).

Capturing Measurement Images for Re-Measurement

Stereo measurement images can be saved allowing the user to perform the actual measurements at a later time on the XL Flex+, Rhythm Review station, or on a PC using the Inspection Manager software

Measurement Procedure

Attach a measurement optical tip, position the probe for maximum accuracy and freeze the image to be saved for re-measurement. Press the joystick's Main Menu button. Select 'Save As' and press  select 'Measurement' and press . Complete other optional fields and press . When complete, use the  soft key, select DONE.

Accuracy Index

The accuracy index is a number that indicates the amount of magnification during stereo measurements. The higher the accuracy index, the greater the magnification. The greater the magnification, the more accurately you can place the measurement cursors allowing for more accurate results.

6 - Measurement

StereoProbe Measurement

Stereo measurements may be taken with the probe perpendicular or not perpendicular to the target.

Types of StereoProbe Measurement

- Length
- Point to Line
- Depth
- Area
- Multi-Segment Line

6 - Measurement

Comparison Measurement

Comparison measurements are to be taken when an item in the image has a known dimension and that item's dimension is used as a reference to measure other items.

Measurement Type	Advantages	Disadvantages
Stereo	<p><i>Over comparison measurements:</i></p> <ul style="list-style-type: none"> • More accurate • No known reference is needed • Measure depth • Surface does not need to be perpendicular to the probe view. • The surface does not need to be perpendicular to the probe view. 	<p>The system may be unable to position matching cursors accurately with any of these conditions in the measurement area:</p> <ul style="list-style-type: none"> • Insufficient detail • Repeating patterns • Glare • Smooth, straight lines to measure along <p>In some cases, the problem can be eliminated by repositioning the probe tip and adjusting the brightness.</p>
Comparison	<ul style="list-style-type: none"> • Use standard optical tip • Measure with tip further away • Measure large objects • Check the approximate size of many items quickly 	<ul style="list-style-type: none"> • Less accurate than stereo measurement • Known references may not be present and may be difficult to deliver to the measurement site • Measurement surface must be nearly perpendicular to the probe view for accurate results

6 - Measurement

StereoProbe Measurement

Stereo measurements require the use of StereoProbe measurement tips, which capture stereoscopic images of a target — two pictures of the same target from two different angles. To measure the target, the XL Flex+ processor uses triangulation based on these two side-by-side images. Stereo measurements can be taken on a frozen image or on a recalled image that was saved in measurement mode.

Positioning the Probe Tip for Maximum Accuracy

Before freezing a stereo measurement image, position the probe tip to meet these criteria:

Visibility: The item to be measured is fully visible in the left and right images.

Tip-to-target proximity: The probe is positioned as close to the target as possible while keeping it in focus.

Vertical orientation: If measuring distance between lines or across a circle, the image is oriented so that cursors can be placed at the left and right edges of the item to be measured — not at top, bottom, or diagonal points. The system needs differentiated details to the left and right of each cursor to accurately place the matching cursors on the right image.

Minimal glare: Glare is minimized by adjusting the viewing angle and the image brightness in the areas where cursors will be placed. Small glare speckles do not present a problem, but larger glare areas may appear in different positions on the two sides causing false matches.

6 - Measurement

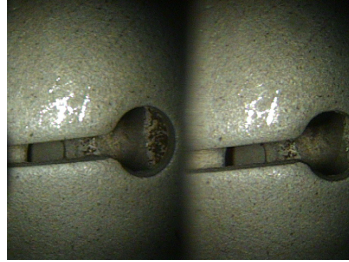

Bad Example

- Object is not fully visible on right side.
- Object is not well lit.
- Object is not oriented to allow proper cursor placement.



Good Example

- Object is fully visible on both sides.
- Object is well lit.
- Object is oriented to allow proper cursor placement.

Accuracy Index

The accuracy index is a number that indicates the amount of magnification during stereo measurements. The higher the accuracy index, the greater the magnification. The greater the magnification, the more accurately you can place the measurement cursors allowing for more accurate results.

When taking stereo measurements, you magnify the image, not by zooming but by moving the optical tip as close as you can to the target.

6 - Measurement

Matching Cursors

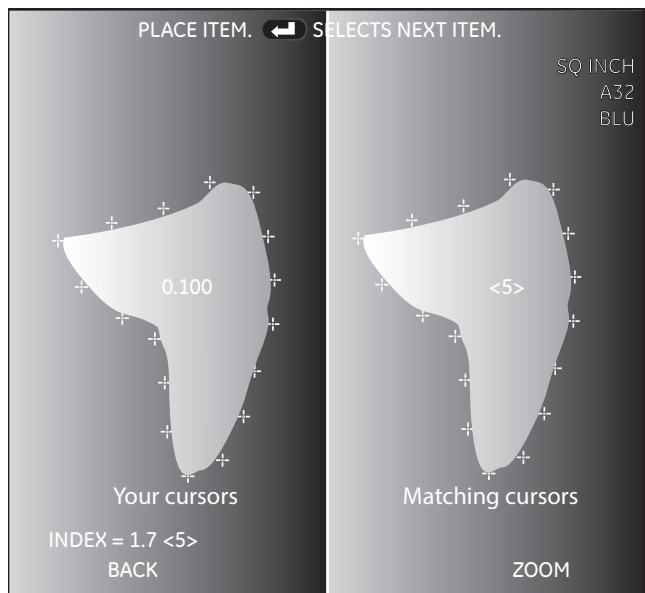

For each cursor the user places on the left image, the system places a matching cursor on the right image.

The left cursors must be placed on an image point that has enough detail to distinguish it from surrounding points. If the neighboring points look the same as the point chosen the system cannot accurately place a matching cursor.

For every matching cursor, the system calculates a match strength value between <0> (lowest confidence) and <5> (highest confidence). If too little detail is present, the system simply does not generate a matching cursor. Whenever possible, achieve a match strength of at least <3>. If this is not possible, capture another image.

Verify that the matching cursor appears to be in the same position as selected cursor. A matching cursor that is off even slightly can have a significant impact on the measurement accuracy.

6 - Measurement

Taking Stereo Measurements

1. Attach the stereo tip securely, and verify it.
2. Position the probe tip for maximum accuracy. Do this by centering the item of interest to be measured while maximizing its magnification.
3. Freeze the image. Stereo measurements require a sharp focus for the best results.
4. Select the measurement type and optical tip.
5. Place the cursors in the left image.

Measurement accuracy depends on all cursors being positioned accurately. To ensure accuracy, press the  right soft key to activate zoom window for a close-up view of the image around the active cursor.

As the first cursor is moved, the matching cursor in the right image moves accordingly.

6. Inspect each matching cursor as soon as it appears.
7. Do not become complacent with high match strength values. Always scrutinize the matching cursor's location.
8. If a matching cursor is not placed correctly, use the  left soft key to go back to the frozen image and start over or recapture a better image.
9. When the measurement result is displayed in the blue background use the joystick to position it at a convenient location not blocking the item of interest.
10. Save the image, or press Freeze/Enter to allow repositioning of any of the cursors or reposition the location of the measurement result.

6 - Measurement

Note: Stereo images are saved without zoom windows, borders, and certain other screen graphics. This way, more of the image is visible if recalled for re-measurement.

Perform any of the following tasks while performing measurements by pressing the joystick's MAIN MENU button to activate the STEREO MENU:

- Add measurements, up to five total
- Add annotation
- Clear some or all measurements.
- Change units
- Select the correct tip in the software (if the tip selected is not the one in use).

6 - Measurement

Types of Stereo Measurement

Length

A Linear (point-to-point) measurement.

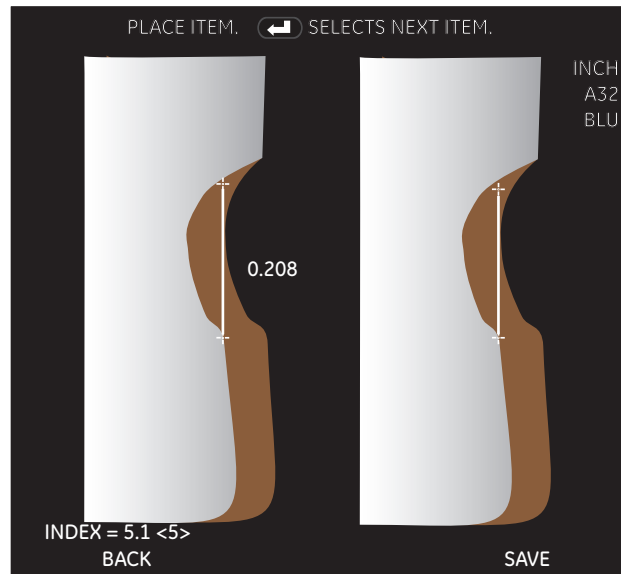

Place the first cursor on the left image at the furthest point of measurement area by pressing the Freeze/Enter button. Place the second cursor at the opposite end of measurement area to determine the length of the feature or defect.

6 - Measurement

Point to Line

The perpendicular distance from a point to a line.



Place the first two cursors to define a reference line. Place a third cursor at the deepest point of the defect or feature. A perpendicular line is generated from the third cursor to the reference line. The measurement displayed is the length of this perpendicular line.

6 - Measurement

Depth

The perpendicular distance between a surface and a point above or below it.



Place first three cursors on an even surface to define a reference plane. Place the fourth cursor at the point of uncertain depth.

Note: Negative measurements indicate the point is below the plane. Positive measurements indicate the point is above the plane.

6 - Measurement

Area

The surface area contained within multiple cursors placed around a feature or defect

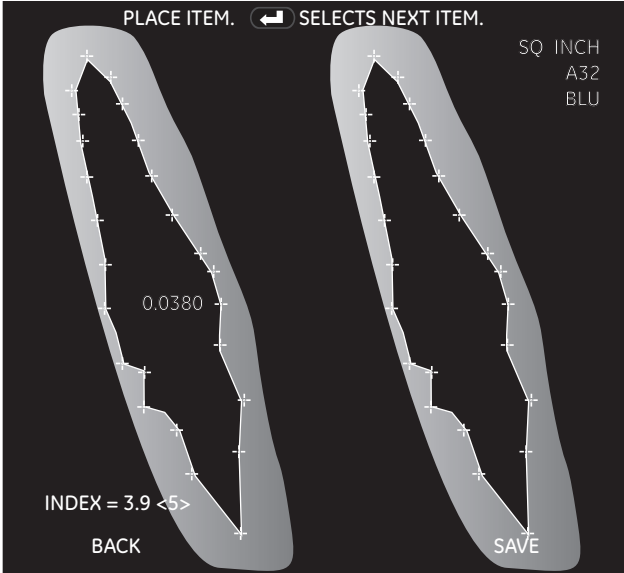

Place between 3 and 24 cursors at edge of desired measurement area.
Press  Freeze/Enter twice to close the measurement area.

6 - Measurement

Multi-Segment Line

The length of a nonlinear feature or defect.



Place between 2 and 24 cursors along feature or defect to create line segments. To finalize line, press  Freeze/Enter twice.

Menu Directed Inspection (MDI)

Menu Directed Inspection (MDI) is the first software tool to standardize the inspection process in the NDT industry. MDI software helps guide inspectors through the inspection process and intelligently auto-generates a report—saving time, improving quality and increasing productivity.

Menu Directed Inspection (MDI) software provides an advantage and convenience during the inspection process. MDI makes labeling images and videos easier and automatically generates reports from the VideoProbe within a few steps.

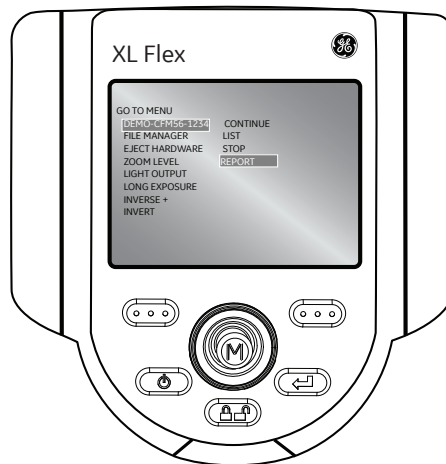

Benefits to using MDI include:

- Standardized Inspection Lists
- Consistent Report Creation in MS Word format
- Data Management
- Decreased reporting time by up to 70%
- Increased speed and ease of sharing data
- Reduction of errors with guided inspections

6 - Measurement

Comparison Measurement

Comparison measurements rely on the known dimensions of an object that have been set in the field of view either by the manufacturer or by the probe. The XL Flex+ processor uses these known dimensions as a reference scale for measuring an unknown target. Comparison measurements can be taken on a frozen image or on a recalled image.

Positioning the Probe Tip for Maximum Accuracy

Position the probe view so the surface is perpendicular to the probe. Target and known object should both be in the same view and plane. Position the probe tip to be as close to the target as possible.

Taking Comparison Measurements

1. Attach any standard forward-view or side-view tip to the probe.
2. Position the probe tip for maximum accuracy.
If the object and reference are small on the screen, zoom until the known object and the target fill the screen as much as possible.
3. Freeze the image.
4. Select the measurement type.
5. Establish the reference distance.
Place the two reference cursors at the endpoints of a known distance. Then adjust the displayed number until it matches that distance.
6. Place the cursors for the feature or defect to be measured.
(Optional) Reposition the cursors and measurement result.
7. (Optional) Perform any of these tasks:
 - Add measurements, up to five total.
 - Clear some or all measurements.
 - Establish a new reference dimension.
8. Save the image.

7 - Maintenance

Inspecting and Cleaning the System

Inspect and clean the XL Flex+ system before and after each use with a soft cloth and a 70% alcohol-to-water solution. If using the system in a dirty environment, clean the components more frequently, as needed.

If damage is found, contact GE Sensing and Inspection Technologies for return instructions and an RMA (return material authorization) number. Early detection of minor conditions can prevent costly repair.

Cleaning Optical Tips

Dirty optical tip surfaces cause distorted or blurred images. For best image quality, clean the optical tip and camera head frequently.

To clean the probe tip, including the lens on the camera head, use glass cleaner or 70% alcohol-to-water solution and a pointed cotton swab. Three surfaces need cleaning: the head can optics, the outside of the tip, and the inside of the tip.

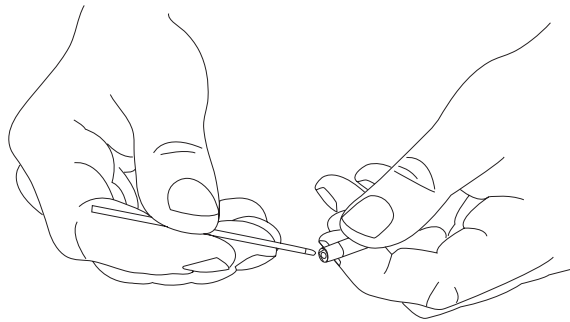

7 - Maintenance

Troubleshooting Measurement

Inaccurate Stereo Measurements

Move the probe tip as close as possible to the target, maximizing magnification.

Verify that the tip is attached to the probe matches the tip information that is selected in the software.

Verify the correct type of measurement has been selected.

Verify that the optical tip is threaded on to the probe head securely.

Measure the target contained in the verification block to ensure that no tip damage has occurred. See Verifying Measurement Tips.

Incorrect measurements can result from dirty tip optics. A tip that visually appears clean may have a film of oil that will negatively affect measurement performance. Follow cleaning directions listed in Maintenance section.

Avoid placing cursors in areas of significant glare. If necessary, adjust the brightness or reposition the probe tip to enhance details and reduce glare.

Verify that the object to be measured is near the center of the screen.

Verify that the matching cursor is correct within 1 pixel. If it is not clearly visible where the match point should be, select a different point, or capture the image from a different angle that better reveals details to allow better matching.

Activate the zoom window to most accurately place the measurement cursors.

Review guidelines under Positioning the Probe Tip for Maximum Accuracy.

7 - Maintenance

Service

To obtain service for a VideoProbe system, please contact one of the service centers below. If the problem cannot be corrected over the phone, a Return Materials Authorization number (RMA) will be given along with instructions for shipment to an authorized service center.

Always contact an authorized Waygate Technologies service center for an RMA prior to returning a product for service and/or repair.

North/South America

Waygate Technologies
721 Visions Drive
Skaneateles, NY 13152
Tel: 888-332-3848
315-554-2000 ext. 1
E-mail: RVI-Service@ge.com

Europe

Baker Hughes Digital Solutions GmbH
7Robert Bosch Str. 3
50354 Huerth
Germany
Tel: +49 2233 601 111 Ext. 1
E-mail: GEITHuerth.Service@ge.com

Asia/Pacific

Baker Hughes Solutions Pte. Ltd.
10 Lok Yang Way
Singapore 628631
Phone: +65 62135500
E-mail: Asia.ServiceIT@ge.com

China

Baker Hughes Sensing & Inspection Co., Ltd.
No. 8 Xi hu Road, Wu jin high-tech zone
Changzhou, Jiang Su 213164
China
Tel: + 86 400 818 1099
E-mail: Service.mcchina@ge.com

Russia

Baker Hughes Rus Infra LLC
Industrial Park "Rosva"
Rosva Kaluga, 248001, Russia
Phone: +7 4842 716 576
E-mail: GEITKaluga.service@ge.com

8 - Technical Specifications

Product Specifications:

Operating Temperature	XL Flex	XL Flex+
Tip	-25°C to 100°C (-13°F to 212°F) Reduced articulation below 0°C (32°F)	-25°C to 100°C (-13°F to 212°F) Reduced articulation below 0°C (32°F)
System	-20° to 46° C (-4°F to 115°F) LCD requires warm-up period below 0°C (32°F)	-20° to 46° C (-4°F to 115°F) LCD requires warm-up period below 0°C (32°F)
Storage Temperature	-25° to 60° C (-13°F to 140°F)	-25° to 60° C (-13°F to 140°F)
Relative Humidity	95% max, non-condensing	95% max, non-condensing
Waterproof	Insertion tube and tip to 14.7 psi (1 bar, 10.2m of H ₂ O, 33.5 ft of H ₂ O)	Insertion tube and tip to 14.7 psi (1 bar, 10.2m of H ₂ O, 33.5 ft of H ₂ O)
Hazardous Environments	Not rated for use in hazardous environments.	Not rated for use in hazardous environments.
Camera		
Diameter Probe	6.1 mm (0.24") 8.4 mm (0.33")	6.1 mm (0.24") 8.4 mm (0.33")
Image Sensor	1/6" Color SUPER HAD™ CCD camera	1/6" Color SUPER HAD™ CCD camera
Pixel Count	440,000 pixels	440,000 pixels
Housing	Titanium	Titanium
Diameter Probe	4.0 mm (0.16")	4.0 mm (0.16")
Image Sensor	1/10" Color SUPER HAD™ CCD camera	1/10" Color SUPER HAD™ CCD camera
Pixel Count	290,000 pixels	290,000 pixels
Housing	Titanium	Titanium

8 - Technical Specifications

System		
System Dimensions	9.5 x 13.3 x 34.3 cm (3.8 x 5.3 x 13.5")	10.2 x 16.5 x 34.3 cm (4.0 x 6.5 x 13.5")
Case Dimensions (Wheeled-Case)	54.9x 34.6x 23.6 cm (21.61x13.62x29")	54.9x 34.6x 23.6 cm (21.61x13.62x29")
System Weight	In Case - 6.5 kg (14.3 lbs) Out of Case - 1.7 kg (3.8 lbs)	In Case - 8.39 kg (18.5 lbs) Out of Case - 1.98 kg (4.37 lbs)
Construction	Polycarbonate housing with integrated Versalon™ bumpers	Polycarbonate housing with integrated Versalon™ and tekprene bumpers
LCD Monitor	Integrated 9.4 cm (3.7") active matrix VGA color LCD, Transflective, sunlight readable display.	Integrated 12.7 cm (5.0") active matrix VGA color LCD, Transmissive display.
Joystick Control	360° All-Way® tip articulation, menu access, and navigation	360° All-Way® tip articulation, menu access, and navigation
Button Set	Access user functions, measurement, and digital functions	Access user functions, measurement, and digital functions
Audio	Integrated 2.5mm headset / microphone jack	Integrated 2.5mm headset / microphone jack
Internal Memory	4GB flash memory	16GB flash memory
Data I/O ports	2 USB 2.0 ports VGA Video Out	2 USB 2.0 ports VGA Video Out
Brightness Control	Auto and Variable	Auto and Variable
Illumination Type	White LED	White LED
Long Exposure	Auto - up to 16 seconds Manual - up to 2.5 seconds	Auto - up to 16 seconds Manual - up to 2.5 seconds
White Balance	Factory default or user defined	Factory default or user defined

8 - Technical Specifications

Power	XL Flex	XL Flex+
Lithium Ion Battery	8.4 V 38 Wh (2-hour) or 75 Wh (4-hour) 2-hour typical runtime - Standard 4-hour typical runtime - Optional	8.4 V 38 Wh (2-hour) or 75 Wh (4-hour) 2-hour typical runtime - Standard 4-hour typical runtime - Optional
Power Supply		
AC	90-264 Vac 47-63 Hz <1.2 A rms @ 90 Vac	90-264 Vac 47-63 Hz <1.2 A rms @ 90 Vac
DC	10.2 V +5% / -3% 4.9 A	10.2 V +5% / -3% 4.9 A
Standards Compliance and Classifications		
MIL-STD-810G	Tested to United States Department of Defense Environment Tests Sections 506.5, 507.5, 509.5, 510.5, 511.5, 514.6, 516.6, 521.3	Tested to United States Department of Defense Environment Tests Sections 506.5, 507.5, 509.5, 510.5, 511.5, 514.6, 516.6, 521.3
MIL-STD-461F	Tested to United States Department of Defense Electromagnetic Interference RS103 - ABOVE DECK	Available Upon Request
Standards Compliance	Group 1, Class A: EN61326-1, UL, IEC, EN CSA-C22.2:61010-1, UN Manual of Tests and Criteria T1-T5 & T7	Group 1, Class B: EN61326-1, UL, IEC, EN CSA-C22.2:61010-1, UN Manual of Tests and Criteria T1-T5 & T7
IP Rating	Tested to IP55	Tested to IP65
Software		
Operating System	Real-time, multi-tasking operating system	Real-time, multi-tasking operating system
User Interface	Simple drop-down, menu-driven operation, menu navigation using articulation joystick	Simple drop-down, menu-driven operation, menu navigation using articulation joystick

8 - Technical Specifications

File Manager	Embedded file manager software supporting: file and folder creation, naming, deleting, storing to internal flash or USB ThumbDrive®, copying between USB and internal flash	Embedded file manager software supporting: file and folder creation, naming, deleting, storing to internal flash or USB ThumbDrive®, copying between USB and internal flash
Audio Data	PC compatible (.aac) file format	PC compatible (.aac) file format
Image Control	Invert, Zoom (5x digital), Image Capture and Recall	Invert, Zoom (5x digital), Image Capture and Recall
Digital Zoom	Continuous (5x)	Continuous (5x)
Image Formats	Bitmap (.BMP), JPEG (.JPG)	Bitmap (.BMP), JPEG (.JPG)
Video Format	MPEG4 (.MP4)	MPEG4 (.MP4)
Text Annotation	Built-in full-screen text overlay generator	Built-in full-screen text overlay generator
Graphic Annotation	User placement of arrows	User placement of arrows
Articulation Control	Steer & Stay Articulation lock/fine articulation, tip “Home” return to neutral forward-tip orientation User-selectable fine or coarse control	Steer & Stay Articulation lock/fine articulation, tip “Home” return to neutral forward-tip orientation User-selectable fine or coarse control
Software Updates	Field upgradable via USB ThumbDrive®	Field upgradable via USB ThumbDrive®
Languages	English, Spanish, French, German, Italian, Russian, Japanese, Korean, Portuguese, Chinese, and Polish	English, Spanish, French, German, Italian, Russian, Japanese, Korean, Portuguese, Chinese, and Polish
Application Software	Menu Directed Inspection (MDI) software digitally guides inspectors through the inspection process, intelligently names files and creates MS Word® compatible inspection reports.	Menu Directed Inspection (MDI) software digitally guides inspectors through the inspection process, intelligently names files and creates MS Word® compatible inspection reports.

8 - Technical Specifications













Probe Measurements for XL Flex / XL Flex+	
Diameter	Length
4.0 mm (0.16")	2.0, 3.0 m (6.6, 9.8 ft.)
6.1 mm (0.24")	2.0, 3.0, 3.5, 4.5, 6.0, 8.0 m (6.6, 9.8, 11.4, 14.8, 19.7, 26.2 ft.)
8.4 mm (0.33")	2.0, 3.0, 4.5, 6.0, 8.0, 10.0 m (6.6, 9.8, 14.8, 19.7, 26.2, 32.8 ft.)

Tip Articulation	
Insertion Tube Length	Articulation
2.0m, 3.0m, 3.5m, and 4.5m	Up/Down 160° min, Left/Right 160° min
6.0m	Up/Down 140° min, Left/Right 140° min
8.0m and 10.0m	Up/Down 120° min, Left/Right 120° min





Note: Typical articulation exceeds minimum specifications.

Appendix







A. Optical Tip Table

Tip	Diameter (mm)	View (DOV)	Color	Field of View (FOV)	Depth of Field (DOF)	Part Number
Standard Optical Tips						
	4.0	Forward	None	80	35-inf (1.38-inf)	T4080FF*
	4.0	Forward	Black	115	4-inf (.16-inf)	T40115FN
	4.0	Side	Red	115	1-30 (.04-1.18)	T40115SN
	4.0	Side	Blue	120	6-inf (.24-inf)	T40120SF
	6.1	Forward	None	50	50mm-infinity 1.97" - infinity	XLG3T6150FF
	6.1	Forward	White	50	12-200mm .47-7.87"	XLG3T6150FG
	6.1	Forward	Black	120	5-120mm .20-4.72"	XLG3T61120FG
	6.1	Forward	Orange	80	3-20mm .12-.79"	XLG3T6180FN
	6.1	Forward	Yellow	90	20mm-infinity .79"-infinity	XLG3T6190FF
	6.1	Forward Oblique	Purple	50	12-80mm .5-3.2"	XLG3T6150FB
	6.1	Side	Brown	50	45mm-infinity 1.77"-infinity	XLG3T6150SF
	6.1	Side	Green	50	9-160mm .35-6.30"	XLG3T6150SG
	6.1	Side	Blue	120	4-100mm .16-3.94"	XLG3T61120SG





Appendix

	6.1	Side	Red	80	1-20mm .04-.79"	XLG3T6180SN
	6.1	Side	Green	50	9-160mm .35-6.30"	XLG3T6150SG
	6.1	Side	Brown	50	45mm 1.77"-infinity	XLG3T6150SF
	8.4	Forward	None	40	250mm-infinity 9.84"-infinity	XLG3T8440FF
	8.4	Forward	Black	120	5-200mm 020.-.87	XLG3T84120FN

Appendix

Stereo Probe Measurement Tips						
	4.0	Forward	Black	55/55	5 mm-inf .20"-inf	TM405555FG
	4.0	Side	Blue	55/55	4mm-inf .16"-inf	TM405555SG
	6.1	Forward	Black	60/60	4-80mm .16-3.15"	XLG3TM616060FG
	6.1	Side	Blue	50/50	2-50mm .08-1.97"	XLG3TM615050SG
	8.4	Forward	Black	60/60	4-50mm .16-1.97"	XLG3TM846060FG
	8.4	Side	Blue	60/60	4-50mm .16-1.97"	XLG3TM846060SG

Appendix

	8.4	Forward	White	40	80mm-500mm 3.15-19.69	XLG3T8440FG
	8.4	Forward	Gold	20	500mm-infinity 19.69"-infinity	XLG3T8420FF
	8.4	Forward	Yellow	80	25-500mm .98-19.69"	XLG3T8480FG
	8.4	Side	Brown	40	250mm-infinity 9.84"-infinity	XLG3T8440SF
	8.4	Side	Green	80	25-500mm .98-19.69"	XLG3T8480SG
	8.4	Side	Blue	120	5-200m .16-7.87"	XLG3T84120SN

Appendix

B. Chemical Compatibility

Chemical compatibility refers to the probe's ability to come into contact with various liquid substances and not be damaged.



WARNING Do not use this system in explosive environments.

These substances are safe for a short duration of contact with the insertion tube:

- Water
- Aircraft Gasoline
- Jet-A-Fuel
- Isopropyl alcohol
- JP-4 Fuel
- Kerosene
- Synthetic Turbo Oil
- Gasoline
- Diesel Fuel
- Hydraulic Oil
- Inhibited Transformer Oil

Subsequent to contact with the above fluids, the insertion tube must be cleaned prior to storage.

Appendix

C. Warranty

Waygate Technologies warrants its VideoProbe components, when new, to be free from defects in material and workmanship and to perform in accordance with manufacturer's specifications under normal use and service for a period of one year from the date of purchase from Waygate Technologies or its authorized distributors, except that, the light source is warranted for a period of 3 years from the date of purchase, the battery is warranted for a period of 30 days from the date of purchase, and where used, servo motors in the articulation drive system are warranted for the life of this VideoProbe product.

Waygate Technologies' obligation under this warranty is limited to the repair or replacement of components determined by Waygate Technologies to be defective within the warranty period at no cost to the original purchaser, except for return shipping expenses. It shall be the purchaser's responsibility to return the product to Waygate Technologies or one of its authorized service centers. The warranty does not cover accessories or optional equipment not manufactured by Waygate Technologies, but these items may be covered by separate manufacturers' warranties.

This warranty extends to the original purchaser and cannot be assigned or transferred to any third party. This warranty shall not apply to any damage or product failure determined by Waygate Technologies to have been caused by misuse, accident (including shipping damage), neglect, improper maintenance, modification or repair by someone other than Waygate Technologies or one of its authorized service representatives.

These express warranties are in lieu of any other warranties, express or implied, including the warranties of merchantability and fitness for a particular purpose, and no other person has been authorized to assume for Waygate Technologies any other liability in connection with the sale of its VideoProbe products. Waygate Technologies shall not be liable for any loss or damages, whether direct or indirect, incidental, or consequential, resulting from the breach of any express warranty set forth herein.

Appendix

D. Verifying Measurement Tips

Verify measurement tips each time they are used to ensure that no mechanical damage has degraded their accuracy.

Every XL Flex+ system equipped with measurement tips is shipped with a measurement verification block. This tool allows for verifying the accuracy of measurement tips. It contains optical measurement targets whose accuracy is traceable to the United States National Institute of Standards and Technology (NIST) measurement standards.

These are the part numbers for the verification blocks used with the XL Flex+ system:

- | | |
|--------------------------------------|-------------------|
| <input type="checkbox"/> VER2400C | For 4.0mm systems |
| <input type="checkbox"/> VER2600C | For 6.1mm systems |
| <input type="checkbox"/> XLG3TM84VER | For 8.4mm systems |

Each measurement verification block comes with a calibration schedule and a Certificate of Calibration (C of C), which notes the calibration date and due date.

Each block has two or more chambers. Each chamber contains two calibrated test targets: 0.1 inch and 1 mm.

To Verify a Measurement Tip:

1. Attach the stereo tip securely.
2. Insert the tip into the appropriate test chamber.
3. Measure the test target using the appropriate metric (inches or millimeters)
4. Evaluate results.

An experienced user can achieve a measurement of 0.100 ± 0.005 inches (1.00 ± 0.05 mm). If the measurement results do not fall within these limits, see Troubleshooting Measurement.

Appendix

E. Environmental Compliance



The equipment purchased has required the extraction and use of natural resources for its production. It may contain hazardous substances that could impact health and the environment.

In order to avoid the dissemination of those substances in the environment and to diminish the pressure on the natural resources, we encourage the use of appropriate take-back systems. Those systems will reuse or recycle most of the materials of end-life equipment in a sound way.

The cross-out wheeled bin symbol encourages the use of those systems.

If more information is needed on the collection, reuse, and recycling systems, please contact the appropriate local or regional waste administration.

EU Battery Directive



This product contains a battery that cannot be disposed of as unsorted municipal waste in the European Union. See the product documentation for specific battery information. The battery is marked with this symbol, which may include lettering to indicate cadmium (Cd), lead (Pb), or mercury (Hg). For proper recycling return the battery to your supplier or to a designated collection point.

What do the markings mean?

Batteries and accumulators must be marked (either on the battery or accumulator or on its packaging, depending on size) with the separate collection symbol. In addition, the marking must include the chemical symbols of specific levels of toxic metals as follows:

Cadmium (Cd) over 0.002%

Lead (Pb) over 0.004%

Mercury (Hg) over 0.0005%

The risks and your role in reducing them

Your participation is an important part of the effort to minimize the impact of batteries and accumulators on the environment and on human health. For proper recycling you can return this product or the batteries or accumulators it contains to your supplier or to a designated collection point. Some batteries or accumulators contain toxic metals that pose serious risks to human health and to the environment. When required, the product marking includes chemical symbols that indicate the presence toxic metals: Pb for lead, Hg for mercury, and Cd for cadmium. Cadmium poisoning can result in cancer of the lungs and prostate gland. Chronic effects include

Appendix

kidney damage, pulmonary emphysema, and bone diseases such as osteomalacia and osteoporosis. Cadmium may also cause anemia, discoloration of the teeth, and loss of smell (anosmia). Lead is poisonous in all forms. It accumulates in the body, so each exposure is significant. Ingestion and inhalation of lead can cause severe damage to human health. Risks include brain damage, convulsions, malnutrition, and sterility. Mercury creates hazardous vapors at room temperature. Exposure to high concentrations of mercury vapor can cause a variety of severe symptoms. Risks include chronic inflammation of mouth and gums, personality change, nervousness, fever, and rashes.

Visit http://ec.europa.eu/environment/waste/weee/index_en.htm for take-back instructions and more information about this initiative.

F. Agency Certifications

European Equipment Classification

Group 1, Class A

The  mark on this product indicates it has been tested to and conforms with the provisions noted within the 2014/30/EU Electromagnetic Compatibility Directive. The XL Flex+ system is in conformance with the following standard: EN61326-1.

Declarations of Conformity are held by Waygate Technologies GmbH:

Baker Hughes Digital Solutions, GmbH
Robert Bosch Str. 3
50354 Huerth
Germany
Tel: +49 2233 601 111 Ext. 1
E-mail: GEITHuerth.Service@ge.com

Safety Mark

The XL Flex+ system is in compliance with the following standards:
UL 61010-1, IEC 61010-1, EN 61010-1 and CSA-C22.2 No. 61010-1.

Appendix

Additional Certification Testing

XL Flex

Tested to MIL-STD-461F: RS103

Tested to MIL-STD-810G: 506.5, 507.5, 509.5, 510.5, 511.5, 514.6, 516.6, 521.3

UN Manual of Tests and Criteria T1-T5 & T7

XL Flex+ -

Tested to MIL-STD-461F: RS103 - **Available upon request**

Tested to MIL-STD-810G: 506.5, 507.5, 509.5, 510.5, 511.5, 514.6, 516.6, 521.3

UN Manual of Tests and Criteria T1-T5 & T7

FCC Compliance

This device complies with part 15 of the FCC Rules. Operation is subject to the following two conditions:

- 1) This device may not cause harmful interference
- 2) this device must accept any interference received, including interference that may cause undesired operation.

This equipment has been tested and found to comply with the limits for a Class A digital device, pursuant to part 15 of the FCC Rules. These limits are designed to provide reasonable protection against harmful interference when the equipment is operated in a commercial environment. This equipment generates, uses, and can radiate radio frequency energy and, if not installed and used in accordance with the instruction manual, may cause harmful interference to radio communications. Operation of this equipment in a residential area is likely to cause harmful interference in which case the user will be required to correct the interference at his own expense.

Appendix

Canadian Notice

This equipment does not exceed the Class A limits for radio noise emissions as described in the Radio Interference Regulations of the Canadian Department of Communications.

Le present appareil numerique n'emet pas de bruits radioelectriques depassant les limites applicables aux appareils numeriques de la classe A prescrites dans le Reglement sur le brouillage radioelectrique edicte par le ministere des Communications du Canada.

G. Creating a Personalized Logo File

The XL Flex+ allows users to display a personalized logo on-screen or store with captured images. Typically, this file will be a corporate logo.

LOGO File Requirements

- 200 x 200 pixels maximum size
- 24 Color
- File name must be logo.jpg
- File must be Microsoft® Windows® compatible

Creating the Logo File

1. Open logo file with image editor.
2. Create custom background comprised of Red 255, Green 0, Blue 255. This will create a magenta-colored background that will appear transparent when loaded on the XL Flex+.
3. Save this file as a .png.
4. Close image editor.
5. Locate the saved file, right click, choose rename. Rename file from logo.png to logo.jpg. This will allow it to be recognized by the XL Flex+.
6. Transfer file to the USB ThumbDrive provided with system.
7. Insert ThumbDrive into USB port on the XL Flex+.
8. Press joystick to enter Live Main Menu
9. Navigate to SETUP > SCREEN/DISPLAY > LOGO
10. Select LOAD
11. Prompt will display "LOGO COPY COMPLETE"

Appendix

H. Open Source Software Availability

There are various open source software packages that have been utilized within this product, and to meet license and copyright obligations, a copy of the source code for each package is available upon request, along with the individual licenses and copyright notices for each, for three years from the date of original installation upon the product.

Requesting these source packages is NOT REQUIRED for operation or use of this product. Additionally, only portions of software on this product fall under open source software licenses, with the remainder merely being an aggregation on the product's storage volumes. Thus NO promise is made NOR implied that source code will be provided for the aggregated proprietary software.

With respect to each open source software distribution, no warranty is expressed nor implied by either the original authors of the software, nor by any other party involved in the distribution of the software. More explicit warranty disclaimers are detailed within the license documentation of each software package, again available upon request. Furthermore such disclaimers and license requirements and restrictions only apply to each open source software package, and DO NOT REFLECT the warranty of the product as a whole.

There are no additional restrictions placed upon copying, distribution, or modification of each software package beyond those of the original licenses, expressed or implied, due to their inclusion in this product.

To request a copy of these open source software packages, please have your product model and serial numbers ready, and call technical support at +1 (866) 243-2638.

Appendix

I. Restoring Factory Defaults

To restore factory defaults, press and hold both Left and Right Soft Keys for five seconds and confirm restoration of factory defaults. Performing this action restores the following options:

- Batter Icon - On
- Date/Time - On
- Date Format - MM/DD/YYYY
- Logo - On
- Temp Icon - On
- Text Color - Green
- Image Format - BMP
- Power Management - On
- Steering Mode - Coarse
- Measurement Accuracy Index - On
- Measurement Units - Inches

NOTE: Upon next restart of VideoProbe after restoring factory defaults, select the desired language from the initial language selection screen

Customer Support Centers

USA

Waygate Technologies, LP
721 Visions Drive
Skaneateles, NY 13152
Tel: 888-332-3848
315-554-2000 ext. 1
E-mail: RemoteService@
BakerHughes.com

Europe

Baker Hughes Digital Solutions
GmbH
7Robert Bosch Str. 3
50354 Huerth
Germany
Tel: +49 2233 601 111 Ext. 1

Asia/Pacific

Baker Hughes Solutions Pte. Ltd.
10 Lok Yang Way
Singapore 628631
Phone: +65 62135500

China

Baker Hughes Sensing & Inspection
Co., Ltd.
No. 8 Xi hu Road, Wu jin high-tech
zone
Changzhou, Jiang Su 213164
China
Tel: + 86 400 818 1099

Russia

Baker Hughes Rus Infra LLC
Industrial Park "Rosva"
Rosva Kaluga, 248001, Russia
Phone: +7 4842 716 576

waygate-tech.com

Assembled in USA

ISO 9001

REGISTERED COMPANY

©2020 Baker Hughes

All rights reserved. Specifications subject to change without notice.

Printed in USA