

## Dealer's Manual

ROAD	MTB	Trekking
City Touring/ Comfort Bike	URBAN SPORT	E-BIKE

# CHAIN

## **XTR**

CN-M9100

## **DEORE XT**

CN-M8100

## **SLX**

CN-M7100

## **DEORE**

CN-M6100

SM-CN910-12

# CONTENTS

---



<b>CONTENTS .....</b>	<b>2</b>
<b>IMPORTANT NOTICE .....</b>	<b>3</b>
<b>TO ENSURE SAFETY .....</b>	<b>4</b>
<b>LIST OF TOOLS TO BE USED .....</b>	<b>7</b>
<b>INSTALLATION/REMOVAL .....</b>	<b>8</b>
Checking the chain length.....	8
Cutting the chain.....	8
Connecting the chain .....	9
Removing the QUICK-LINK .....	10

# IMPORTANT NOTICE

- **This dealer's manual is intended primarily for use by professional bicycle mechanics.**  
Users who are not professionally trained for bicycle assembly should not attempt to install the components themselves using the dealer's manuals.  
If any part of the information on the manual is unclear to you, do not proceed with the installation. Instead, contact your place of purchase or a distributor for assistance.
- Make sure to read all manuals included with the product.
- Do not disassemble or modify the product other than as stated in the information contained in this dealer's manual.
- All manuals and technical documents are accessible online at <https://si.shimano.com>.
- For consumers who do not have easy access to the internet, please contact a SHIMANO distributor or any of the SHIMANO offices to obtain a hardcopy of the User's Manual.
- Please observe the appropriate rules and regulations of the country, state or region in which you conduct your business as a dealer.

**For safety, be sure to read this dealer's manual thoroughly before use, and follow it for correct use.**

The following instructions must be observed at all times in order to prevent personal injury and physical damage to equipment and surroundings.  
The instructions are classified according to the degree of danger or damage which may occur if the product is used incorrectly.

 <b>DANGER</b>	Failure to follow the instructions will result in death or serious injury.
 <b>WARNING</b>	Failure to follow the instructions could result in death or serious injury.
 <b>CAUTION</b>	Failure to follow the instructions could cause personal injury or physical damage to equipment and surroundings.

# TO ENSURE SAFETY

## WARNING

- **Be sure to follow the instructions provided in the manuals when installing the product.**  
Only use SHIMANO genuine parts. If a component or replacement part is incorrectly assembled or adjusted, it can lead to component failure and cause the rider to lose control and crash.
-  Wear approved eye protection while performing maintenance tasks such as replacing components.

### Be sure to also inform users of the following:

- Do not reuse a QUICK-LINK that has been removed. If the QUICK-LINK is reused, there is a risk that it will loosen and become detached, which could cause the rider to lose control of the bicycle and fall.
- Clean the chain and QUICK-LINK regularly with an appropriate chain cleaner. Intervals between maintenance depend on the riding circumstances. Never use alkali based or acid based solvents such as rust cleaners. If any of these are used, the chain or QUICK-LINK might break resulting in serious injury.
- If it is necessary to readjust the length of the chain due to a change in the sprocket configuration, etc., cut the chain in a place other than where it has been joined by a QUICK-LINK. The chain cutter will be damaged if the chain is cut at a place where it has been joined by a QUICK-LINK.
- Check the chain and QUICK-LINK for any damage (deformations or cracking), chain skipping, or other abnormalities such as unintended gear shifting. If any problems are found, consult your place of purchase or a distributor. There is a risk of the chain breaking or the QUICK-LINK detaching, which may cause you to fall off the bicycle.
- When replacing the chain with a new one, be sure to replace the QUICK-LINK with a new one as well. If the QUICK-LINK is not replaced, it may become damaged and you may fall off the bicycle.
- When installing the QUICK-LINK, make sure that the QUICK-LINK pins are inserted securely as far as they will go.

## For installation to the bicycle, and maintenance:

- Only use the tool and QUICK-LINK models specified in the table to connect the chain. If an unsuitable QUICK-LINK or tool is used to connect the chain, insufficient connecting force may cause chain separation or skipping.

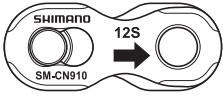
Chain	QUICK-LINK	Tool (QUICK-LINK)	Tool (chain cutter)
CN-M9100/ CN-M8100/ CN-M7100/ CN-M6100	SM-CN910-12 	TL-CN10	TL-CN29, TL-CN35

- Install so that the arrow on the surface is pointing in the rotation direction of the crank when viewed from the front. If it is not installed correctly, the QUICK-LINK could detach, which may cause you to fall off the bicycle.

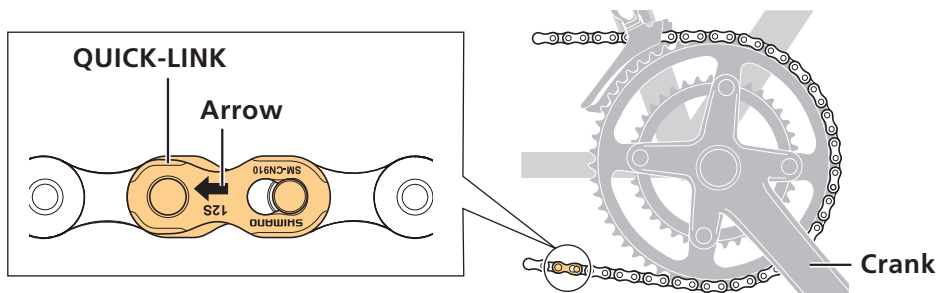

- Read this manual carefully, and keep it in a safe place for later reference.

## NOTICE

### Be sure to also inform users of the following:

- The gears should be periodically washed with a neutral detergent and then lubricated. In addition, cleaning the chain and QUICK-LINK with a neutral detergent and lubricating them can be an effective way of extending the life of the chain and QUICK-LINK.
- A SHIMANO original tool is required to remove the QUICK-LINK. Consult a place of purchase or a distributor.
- Products are not guaranteed against natural wear and deterioration from normal use and aging.
- For maximum performance we highly recommend SHIMANO lubricants and maintenance products.

## For installation to the bicycle, and maintenance:

- In order to achieve good gear shifting performance, this chain has a front side and a reverse side and must be fitted in the correct orientation.

- Front (outer side)

The side with the mark shown in the figure is the front (outer side).





- Reverse (inner side)



The actual product may differ from the illustration because this manual is intended mainly to explain the procedures for using the product.

# LIST OF TOOLS TO BE USED

The following tools are needed for installation/removal, adjustment, and maintenance purposes.

Tool	
	TL-CN29
	TL-CN35
	TL-CN10

# INSTALLATION/REMOVAL

## Checking the chain length

Refer to the dealer's manual of the rear derailleur for the method to check the length of the chain.

## Cutting the chain

If the chain is too long, use the chain cutter and cut the chain.

### 1. Place the chain in the chain cutter.

**NOTICE**

- Place the chain in the chain cutter as shown in the figure. If the chain cutter is used without properly placing the chain, the positioning plate may be damaged.

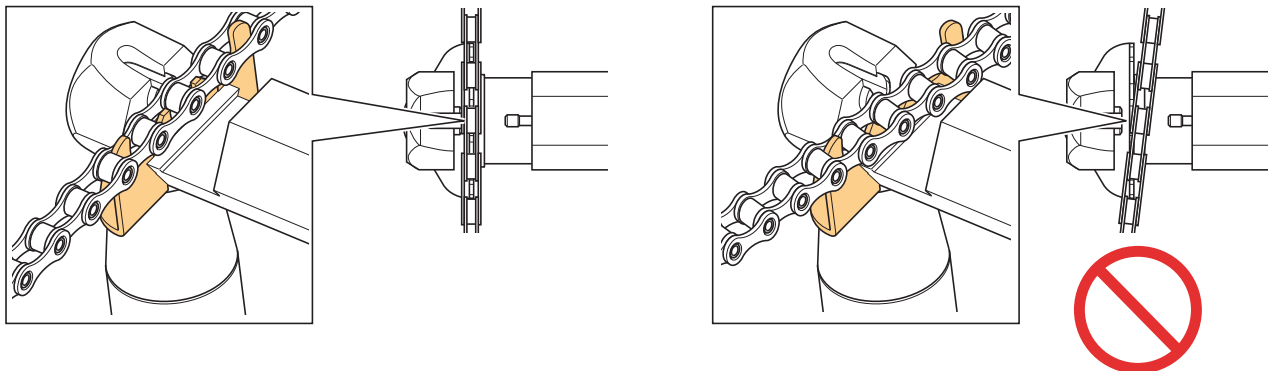

### 2. Turn the handle of the chain cutter to push out the pin.

Push the center of the pin to completely remove the pin from the chain.

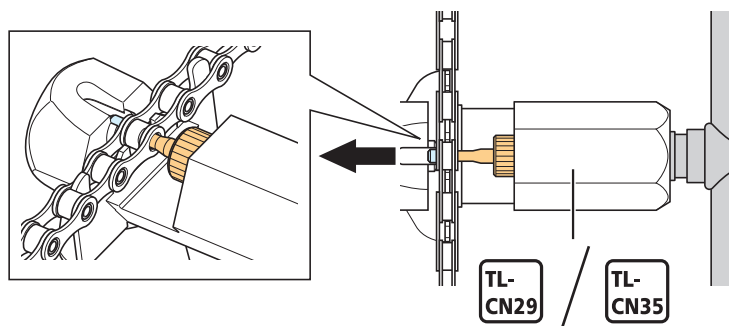



# Connecting the chain

Instead of connecting this product with a conventional connecting pin, use a QUICK-LINK to connect the chain.

## 1. Install the QUICK-LINK onto the chain.

Insert the QUICK-LINK pins between the inner links from both sides as shown in the figure. Place so that the arrow on the surface is pointing in the rotation direction of the crank when viewed from the front.

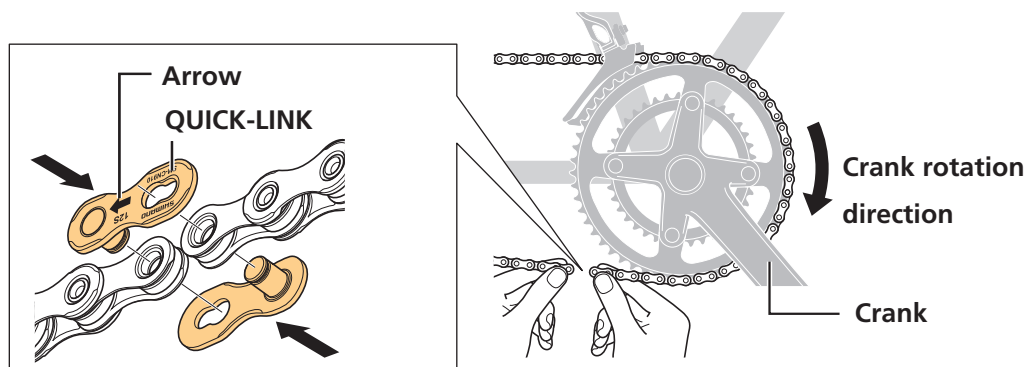

## 2. Secure the QUICK-LINK.

Use SHIMANO original tool TL-CN10 to slide the pins and insert them securely.

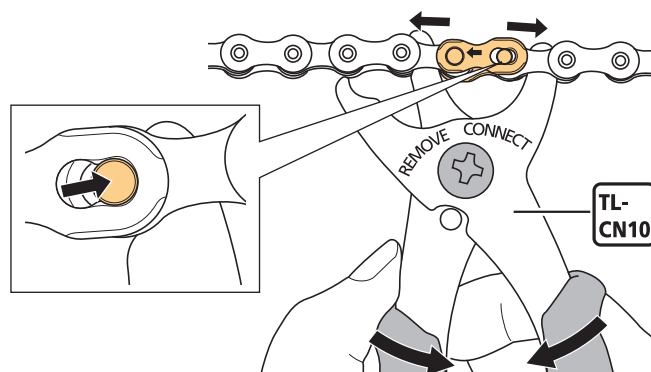

### NOTICE

- Make sure that both sides of the QUICK-LINK are inserted securely as shown in the figure.

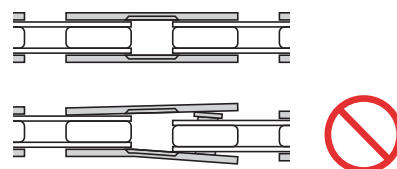

# Removing the QUICK-LINK

1. Use SHIMANO original tool TL-CN10 to remove the QUICK-LINK.

Place the tool as shown in the figure, and then slide the pins and remove the QUICK-LINK.

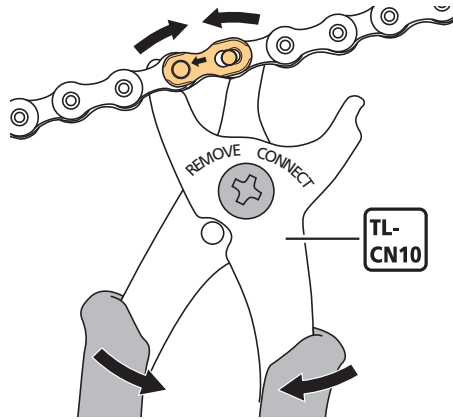

# SHIMANO

**SHIMANO NORTH AMERICA BICYCLE, INC.**

One Holland, Irvine, California 92618, U.S.A. Phone: +1-949-951-5003

**SHIMANO EUROPE B.V.**

High Tech Campus 92, 5656 AG Eindhoven, The Netherlands Phone: +31-402-612222

**SHIMANO INC.**

3-77 Oimatsu-cho, Sakai-ku, Sakai City, Osaka 590-8577, Japan

Please note: specifications are subject to change for improvement without notice. (English)

© Oct. 2019 by SHIMANO INC. ITP