

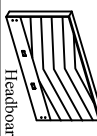

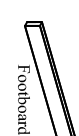









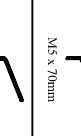

ASSEMBLY INSTRUCTION

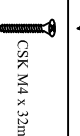
MODEL : CF 9123 (6')

A		1 pc
B		1 pc
C		2 pcs
D		4 pcs
E		2 pcs
F		4 pcs
G		1 pc
H		4 pcs
I		1 pc
J		1 pc
K		20 pcs
L		38 pcs
M		4 pcs
N		8 pcs
O		16 pcs

Step 1 : Install the legs (D) to footboard (B) and headboard (A). Tighten the legs.

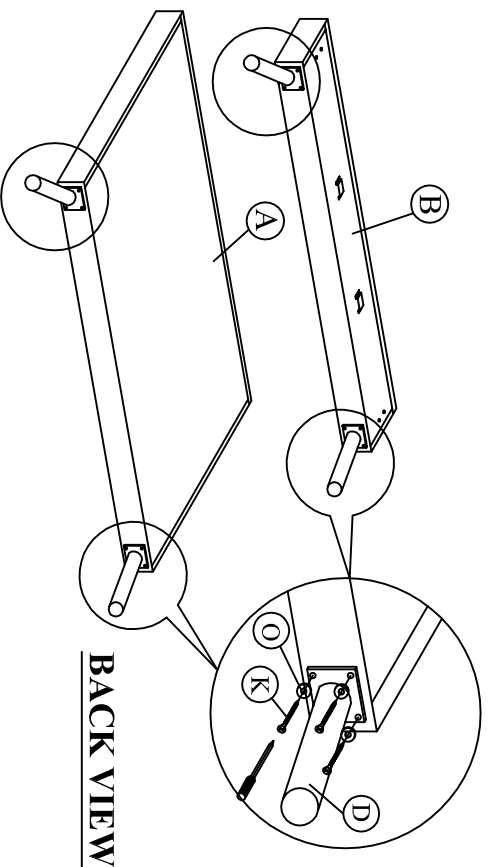

Step 3 : Attach the support legs (F) to the center rail (E) of the bed as shown.

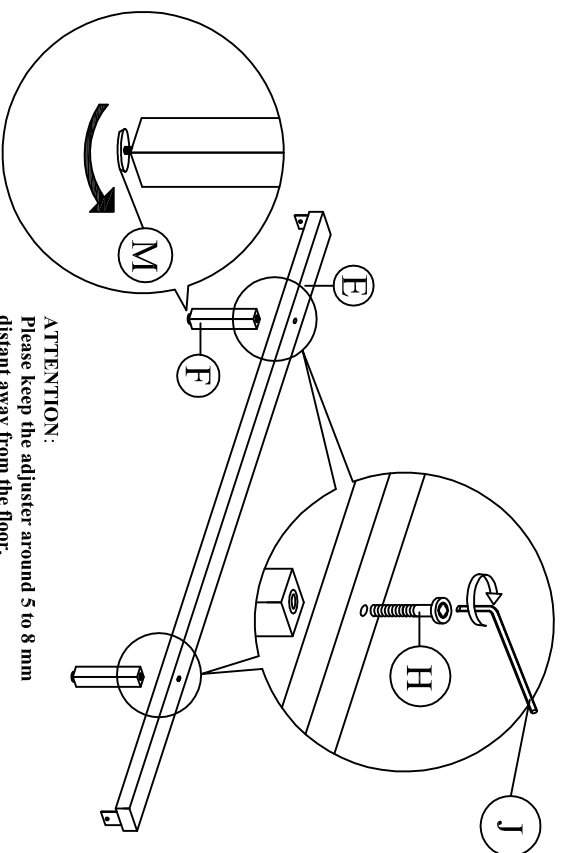

ATTENTION:
Please keep the adjuster around 5 to 8 mm distant away from the floor.

Step 2 : Attach side rail (C) to footboard (B) and headboard (A) by pushing the bracket down to fit it.

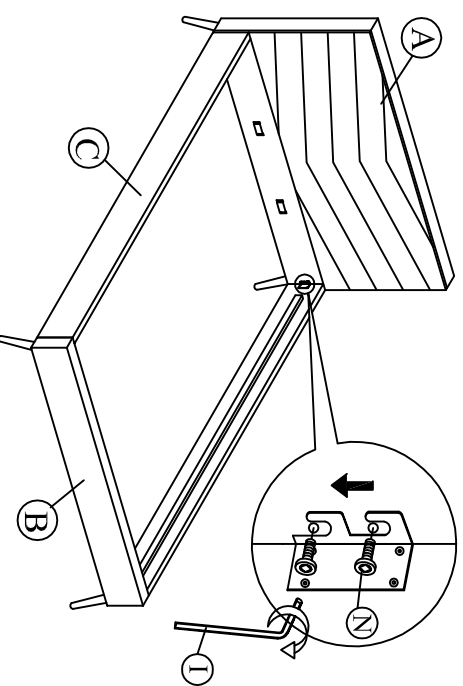

Step 4 : Slide the center rail (E) to the headboard (A) and footboard (B). Tighten screws (K) using screw driver (not included) to the headboard (A) and footboard (B)

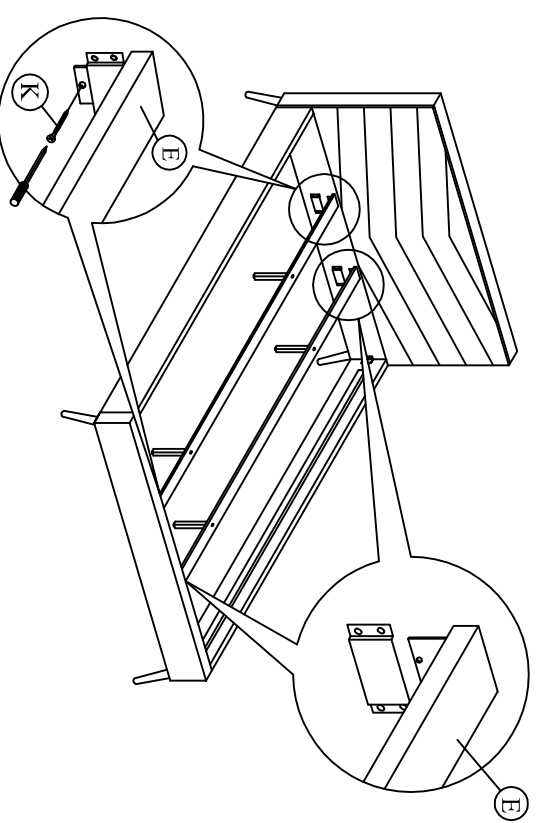

Step 5 : Affix the Slat (G) to the side rail support wood and the center rail (E).

