

Protistor® size 2x32 and 2x33 aR

400 to 690VAC (IEC) / 700VAC (UL)

SEMICONDUCTOR PROTECTION FUSES

SQUARE BODY HIGH-SPEED FUSE-LINKS AC PROTECTION



The 690/700V Protistor® fuse-links provide maximum flexibility in equipment design and ultimate protection for today's power conversion equipment. These square body ultra-fast acting aR fuse-links are available in different body sizes, each size having multiple worldwide acceptable mounting styles.

They have been engineered to provide state-of-the-art protection for semiconductors: diodes, thyristors and IGBT devices. They are assembled with die-cut elements embedded in solidified sand, which helps control arcing characteristics for a lower I^2t and high interrupting rating level. All contact surfaces are silver plated and all hardware is non-magnetic.

Each fuse-link can be equipped with a low voltage trip-indicator which can operate a field mountable microswitch.

TECHNICAL DATA OVERVIEW

Voltage Range AC	400 ... 690 VAC
Ampere Range (A)	800 ... 5000 A
Speed/Characteristic	aR
I.R. AC	130 ... 200 kA
Product Size	2x32 and 2x33

FEATURES & BENEFITS

- Multiple body sizes and terminals or blades combination
- aR Class according to IEC 60269-4 and VDE 636-23
- Very low I^2t for improved semiconductor protection
- Ultra fast acting
- Current limiting
- Superior cycling capability

APPLICATIONS

- Protection of inverters, motor drives, UPS systems and similar 690V or less equipments.

STANDARDS

- IEC 60269-4 Compliance
- UL/CSA Recognized E76491 (For some items)



Protistor® size 2x32 and 2x33 aR

400 to 690VAC (IEC) / 700VAC (UL)

PRODUCT RANGE



PC232UD69V8CTF

Size 2x32 type TTF M10 threaded terminals with omega bar

Catalog number	Item number	Rated voltage AC (IEC)	Rated voltage AC (UL)	Rated current I _n	Pre-arcing I ² t	Clearing I ² t at Rated Voltage	Rated breaking capacity AC	Power dissipation at I _n	UL certified	Package	Weight
PC232UD69V8CTF	T300305	690 V	700 V	800 A	61 kA ² s	320 kA ² s	170 kA	144 W	x	1	1.33 kg
PC232UD69V10CTF	T300213	690 V	700 V	1000 A	111 kA ² s	590 kA ² s	170 kA	165 W	x	1	1.33 kg
PC232UD69V13CTF	V300214	690 V	700 V	1250 A	218 kA ² s	1100 kA ² s	170 kA	190 W	x	1	1.33 kg
PC232UD69V14CTF	G300087	690 V	700 V	1400 A	307 kA ² s	1600 kA ² s	170 kA	200 W	x	1	1.33 kg



PC233UD69V13CTF

Size 2x33 type M12 threaded terminals with omega bar

Catalog number	Item number	Rated voltage AC (IEC)	Rated voltage AC (UL)	Rated current I _n	Pre-arcing I ² t	Clearing I ² t at Rated Voltage	Rated breaking capacity AC	Power dissipation at I _n	UL certified	Package	Weight
PC233UD60V20CTF	H1027693	600 V	700 V	2000 A	683 kA ² s	3100 kA ² s	160 kA	280 W	x	1	1.98 kg
PC233UD60V22CTF	J1027694	600 V	700 V	2200 A	957 kA ² s	4400 kA ² s	160 kA	295 W	x	1	1.98 kg
PC233UD60V25CTF	X302217	600 V	700 V	2500 A	1420 kA ² s	6600 kA ² s	160 kA	310 W	x	1	1.98 kg
PC233UD60V28CTF	J232745	600 V	700 V	2800 A	1860 kA ² s	8800 kA ² s	160 kA	330 W	x	1	1.98 kg
PC233UD69V13CTF	D300268	690 V	700 V	1250 A	159 kA ² s	850 kA ² s	170 kA	230 W	x	1	1.98 kg
PC233UD69V14CTF	E300269	690 V	700 V	1400 A	228 kA ² s	1200 kA ² s	170 kA	240 W	x	1	1.98 kg
PC233UD69V16CTF	F300270	690 V	700 V	1600 A	370 kA ² s	1900 kA ² s	170 kA	250 W	x	1	1.98 kg
PC233UD69V18CTF	W1069036	690 V	700 V	1800 A	515 kA ² s	2800 kA ² s	170 kA	265 W	x	1	1.98 kg



PC36UD69V18CP11

Size 2x33 type PLAF M10 threaded plates

Catalog number	Item number	Rated voltage AC (IEC)	Rated voltage AC (UL)	Rated current I _n	Pre-arcing I ² t	Clearing I ² t at Rated Voltage	Rated breaking capacity AC	Power dissipation at I _n	UL certified	Package	Weight
PC36UD69V18CP11	B300427	690 V	700 V	1800 A	515 kA ² s	2800 kA ² s	170 kA	250 W	x	1	2.5 kg
PC36UD60V20CP11	R302235	600 V	650 V	2000 A	682 kA ² s	3100 kA ² s	160 kA	280 W	-	1	2.5 kg
PC36UD60V22CP11	Q302234	600 V	650 V	2200 A	957 kA ² s	4400 kA ² s	160 kA	280 W	x	1	2.5 kg
PC36UD60V25CP11	P302233	600 V	650 V	2500 A	1410 kA ² s	6600 kA ² s	160 kA	310 W	x	1	2.5 kg
PC36UD60V28CP11	N302232	600 V	650 V	2800 A	1855 kA ² s	8800 kA ² s	160 kA	330 W	x	1	2.5 kg
PC36UD55V30CP11	L301977	550 V	600 V	3000 A	1870 kA ² s	9000 kA ² s	150 kA	440 W	-	1	2.5 kg
PC36UD55V32CP11	M301978	550 V	600 V	3200 A	2220 kA ² s	10800 kA ² s	150 kA	455 W	x	1	2.5 kg
PC36UD50V36CP11	N301979	500 V	550 V	3600 A	2880 kA ² s	12400 kA ² s	130 kA	465 W	x	1	2.5 kg
PC36UD50V40CP11	P301980	500 V	550 V	4000 A	3790 kA ² s	16200 kA ² s	130 kA	515 W	-	1	2.5 kg
PC36UD45V45CP11	Q301981	450 V	500 V	4500 A	5000 kA ² s	18600 kA ² s	130 kA	560 W	-	1	2.5 kg
PC36UD40V50CP11	R301982	400 V	400 V	5000 A	7470 kA ² s	23100 kA ² s	200 kA	580 W	-	1	2.5 kg

Protistor® size 2x32 and 2x33 aR

400 to 690VAC (IEC) / 700VAC (UL)

TIME CURRENT CHARACTERISTIC CURVES

Size 2x32

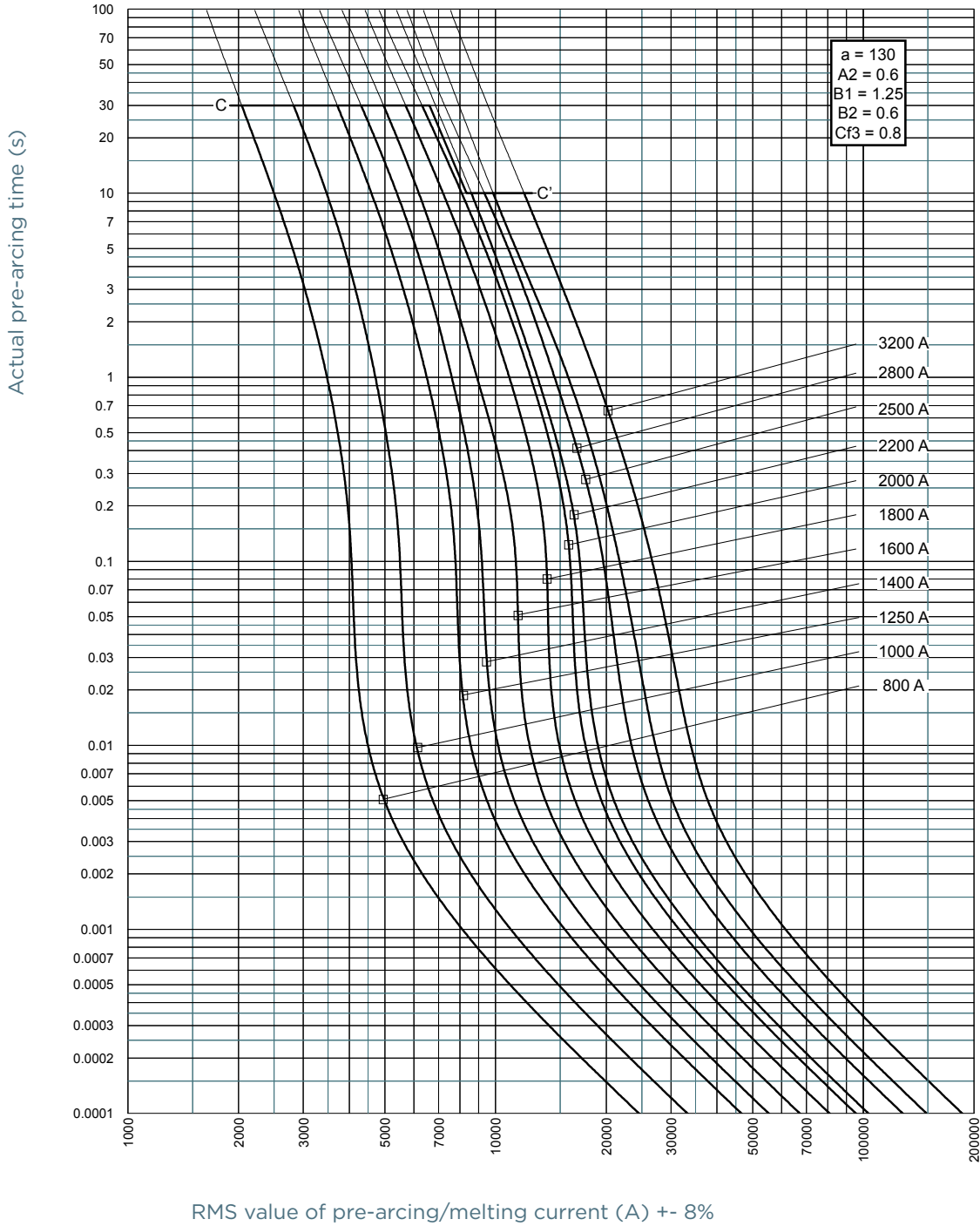

Mersen products have been designed by Mersen for a range of specific applications to be operated depending on particular specification and conditions. Mersen makes no representation or/and warranty, and waives any liability, either express or implied for products' reliability and life time or technical performance in case Mersen has not been provided with customer's specifications or if the products are not purchased directly from Mersen or its distributors and/or agents.

TIME CURRENT CHARACTERISTIC CURVES

Size 2x33

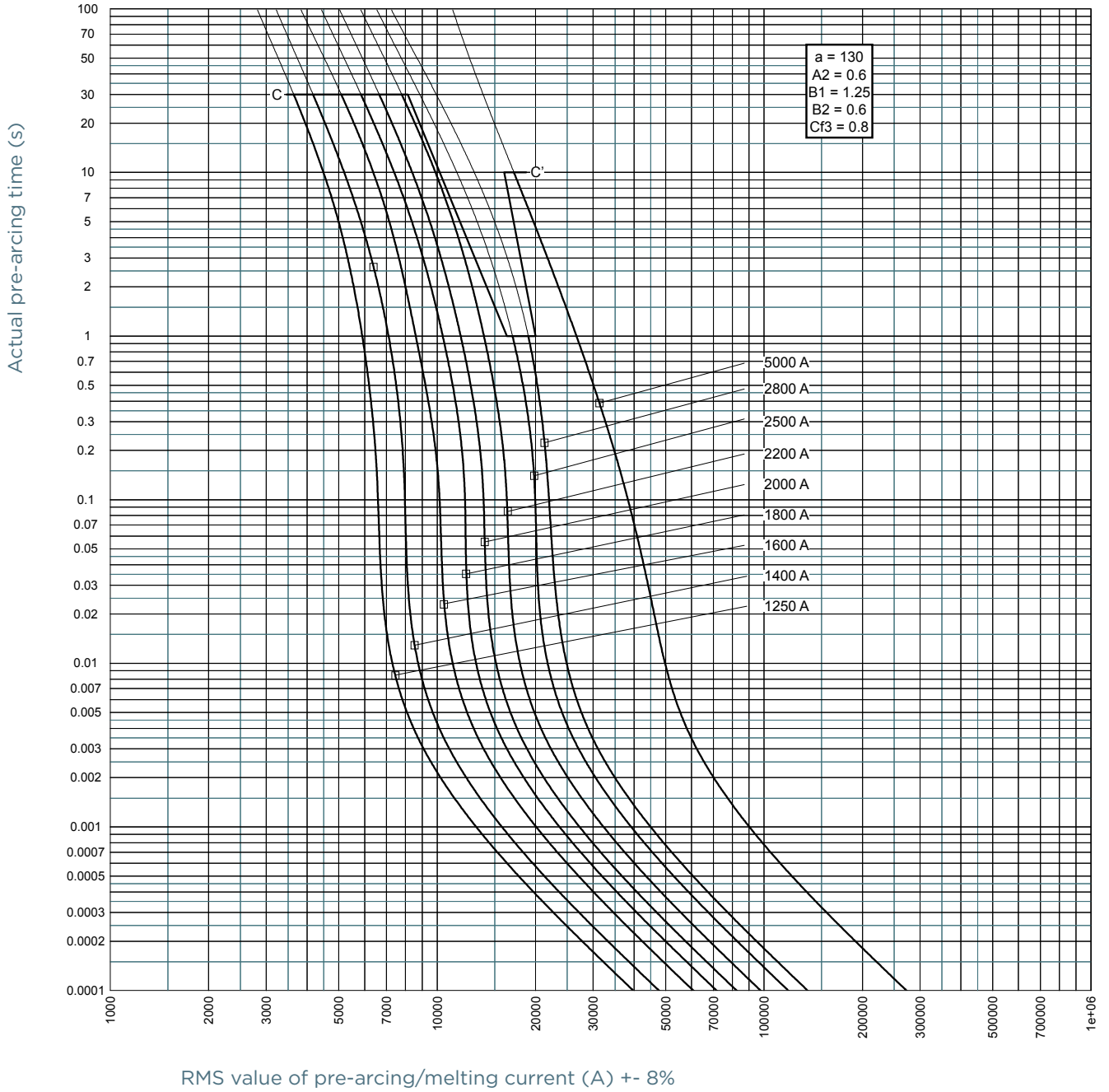

Protistor® size 2x32 and 2x33 aR

400 to 690VAC (IEC) / 700VAC (UL)

CUT-OFF CURRENT CHARACTERISTIC

Size 2x32

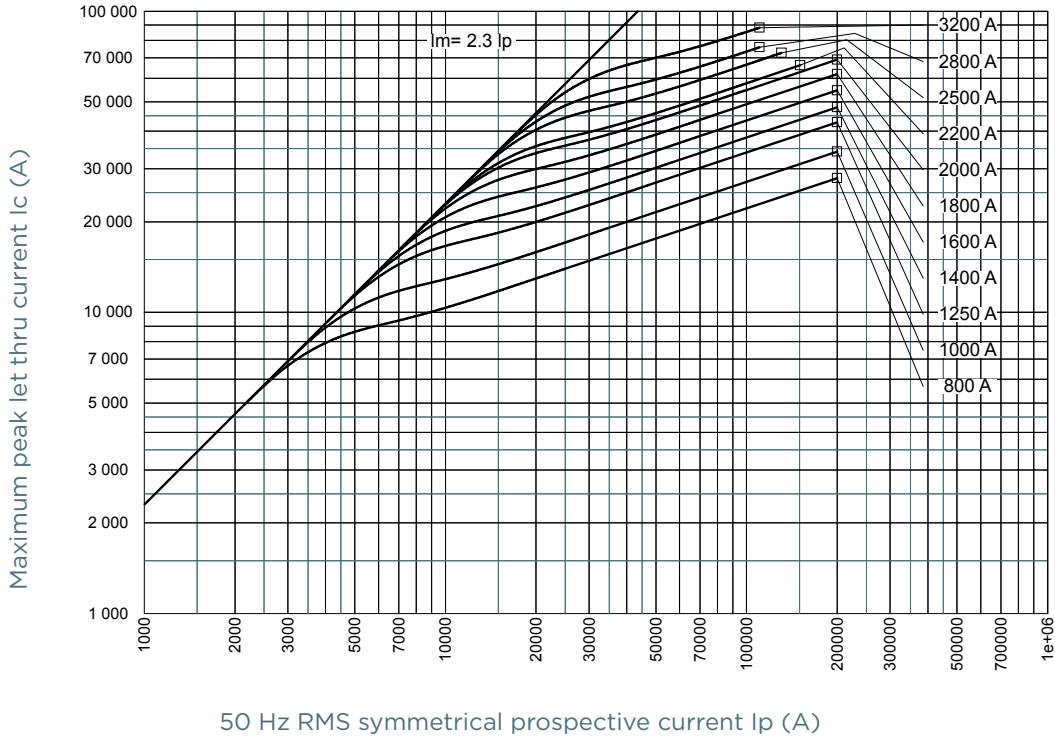

Size 2x33

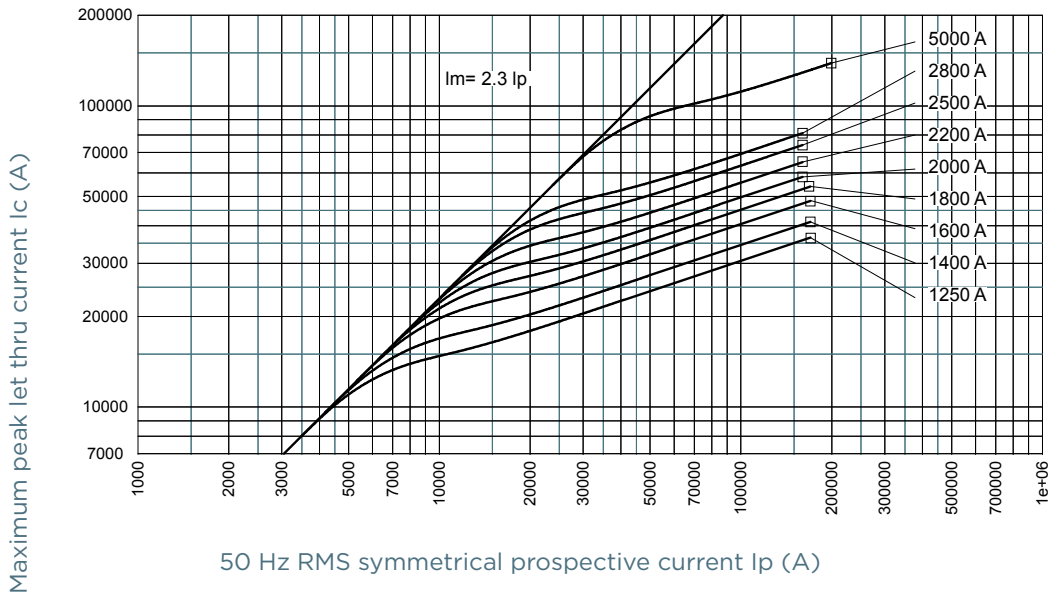

Mersen products have been designed by Mersen for a range of specific applications to be operated depending on particular specification and conditions. Mersen makes no representation or/and warranty, and waives any liability, either express or implied for products' reliability and life time or technical performance in case Mersen has not been provided with customer's specifications or if the products are not purchased directly from Mersen or its distributors and/or agents.

Protistor® size 2x32 and 2x33 aR

400 to 690VAC (IEC) / 700VAC (UL)

I²T MULTIPLIER COEFFICIENT

Size 2x32 450V

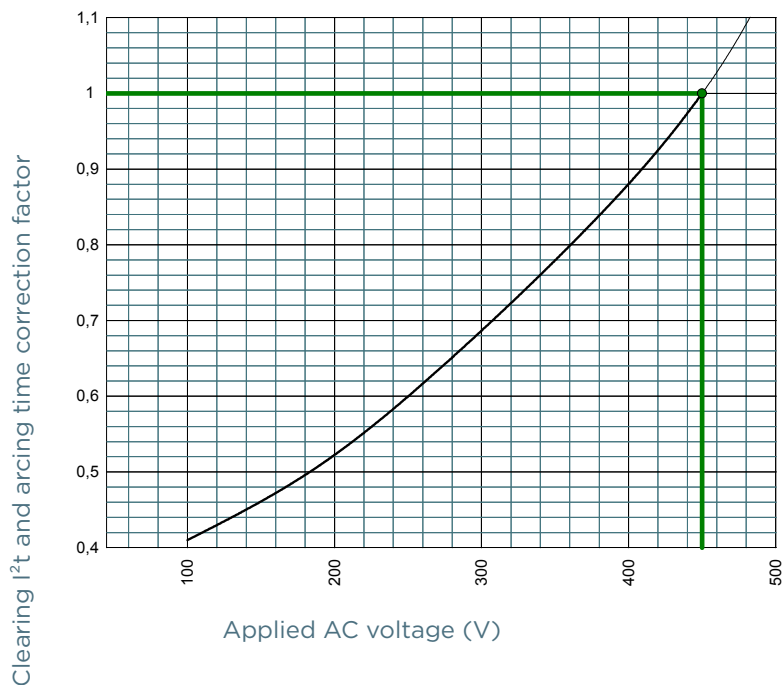

Size 2x32 500V

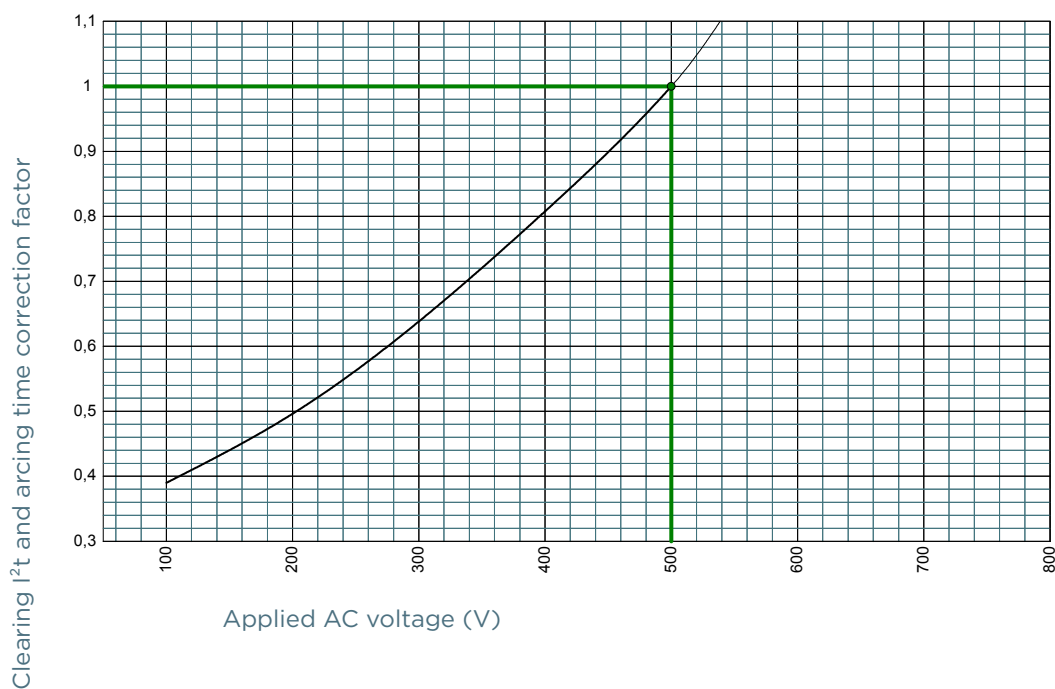

Mersen products have been designed by Mersen for a range of specific applications to be operated depending on particular specification and conditions. Mersen makes no representation or/and warranty, and waives any liability, either express or implied for products' reliability and life time or technical performance in case Mersen has not been provided with customer's specifications or if the products are not purchased directly from Mersen or its distributors and/or agents.

Protistor® size 2x32 and 2x33 aR

400 to 690VAC (IEC) / 700VAC (UL)

I²T MULTIPLIER COEFFICIENT

Size 2x32 550V

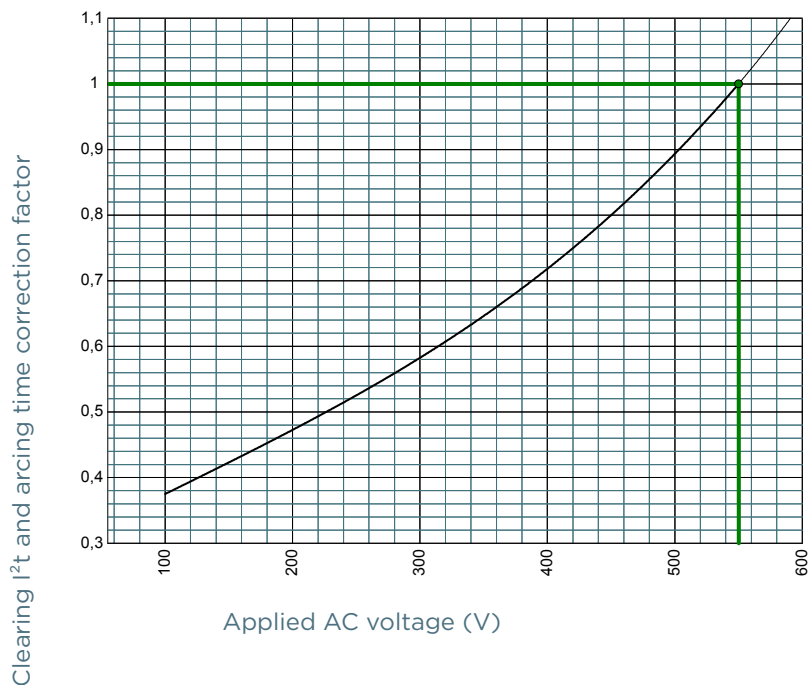

Size 2x32 690V

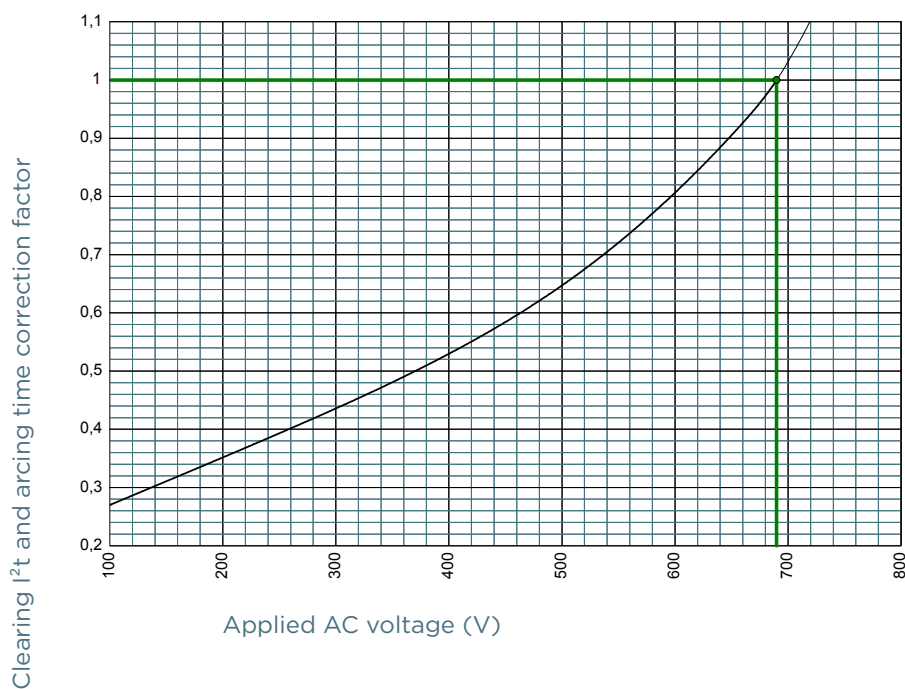

Mersen products have been designed by Mersen for a range of specific applications to be operated depending on particular specification and conditions. Mersen makes no representation or/and warranty, and waives any liability, either express or implied for products' reliability and life time or technical performance in case Mersen has not been provided with customer's specifications or if the products are not purchased directly from Mersen or its distributors and/or agents.

Protistor® size 2x32 and 2x33 aR

400 to 690VAC (IEC) / 700VAC (UL)

I²T MULTIPLIER COEFFICIENT

Size 2x33 400V

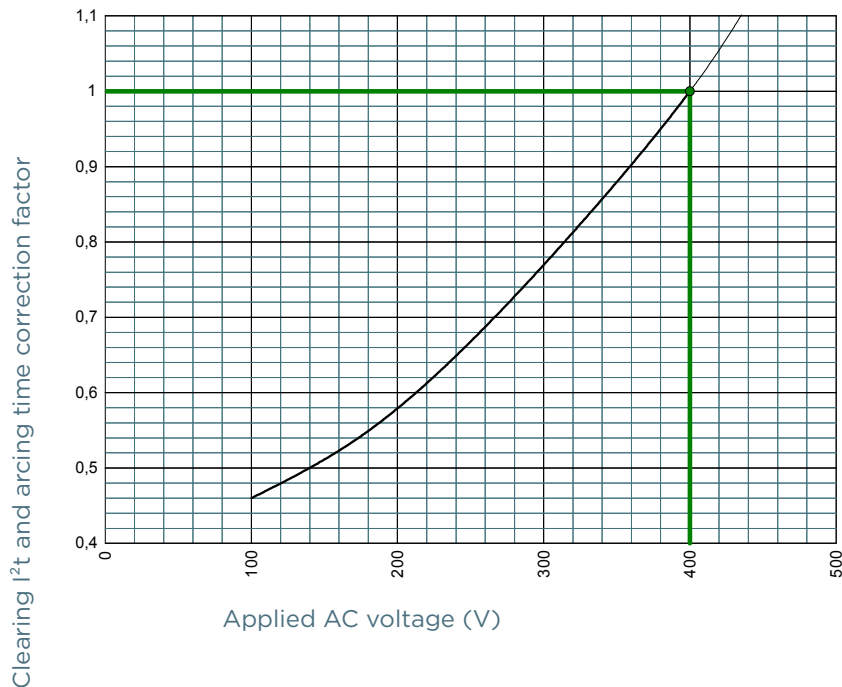

Size 2x33 600V

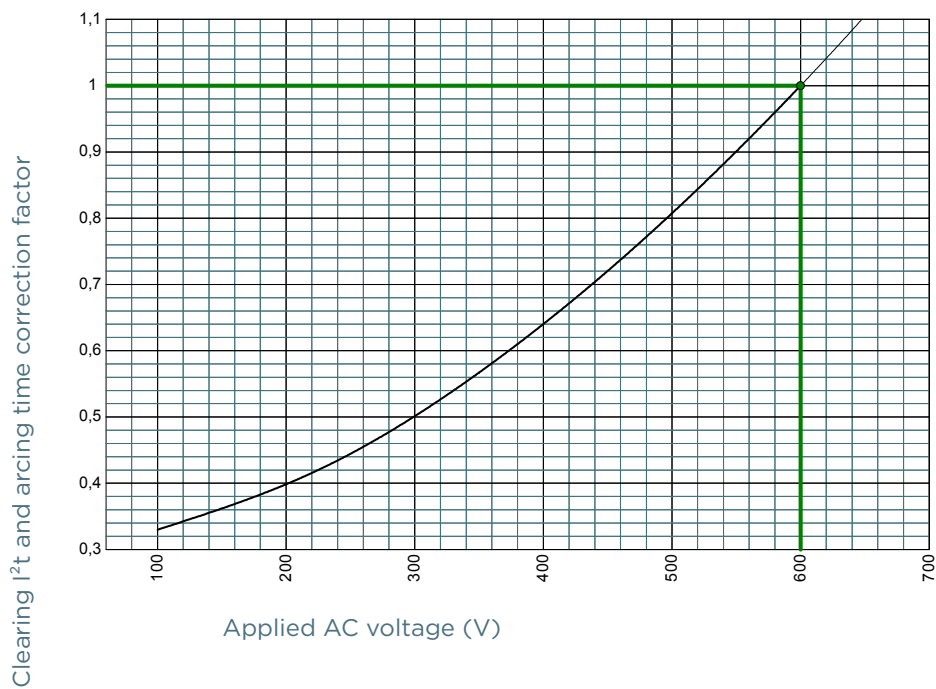

Mersen products have been designed by Mersen for a range of specific applications to be operated depending on particular specification and conditions. Mersen makes no representation or/and warranty, and waives any liability, either express or implied for products' reliability and life time or technical performance in case Mersen has not been provided with customer's specifications or if the products are not purchased directly from Mersen or its distributors and/or agents.

Protistor® size 2x32 and 2x33 aR

400 to 690VAC (IEC) / 700VAC (UL)

I²T MULTIPLIER COEFFICIENT

Size 2x33 690V

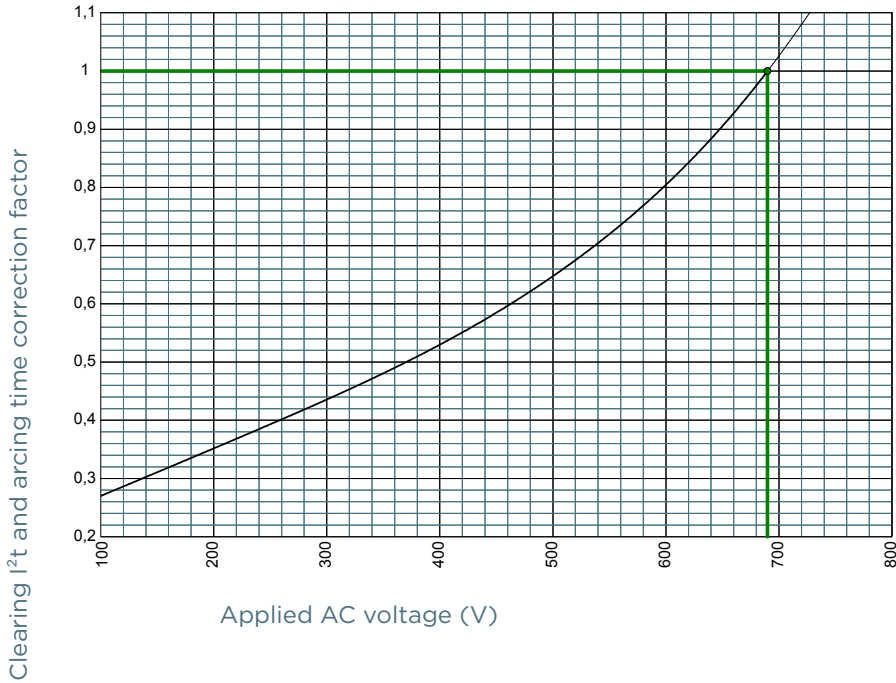

CHARACTERISTICS TOTAL I²T CURVE

Size 2x32 450V

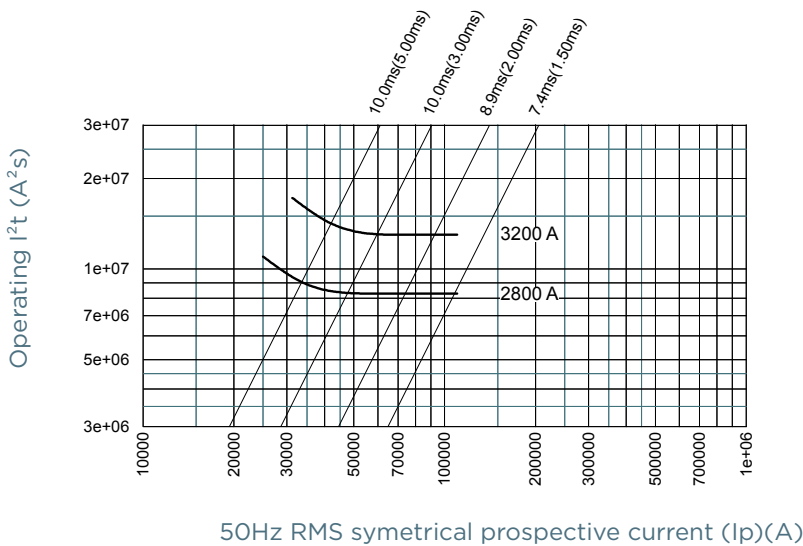

Mersen products have been designed by Mersen for a range of specific applications to be operated depending on particular specification and conditions. Mersen makes no representation or/and warranty, and waives any liability, either express or implied for products' reliability and life time or technical performance in case Mersen has not been provided with customer's specifications or if the products are not purchased directly from Mersen or its distributors and/or agents.

Protistor® size 2x32 and 2x33 aR

400 to 690VAC (IEC) / 700VAC (UL)

CHARACTERISTICS TOTAL I²T CURVE

Size 2x32 500V

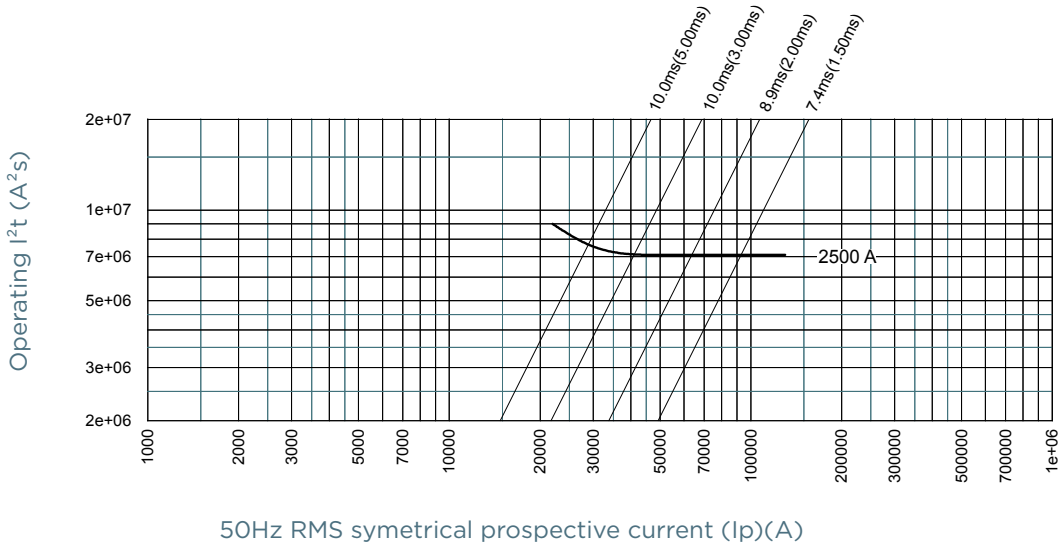

Size 2x32 550V

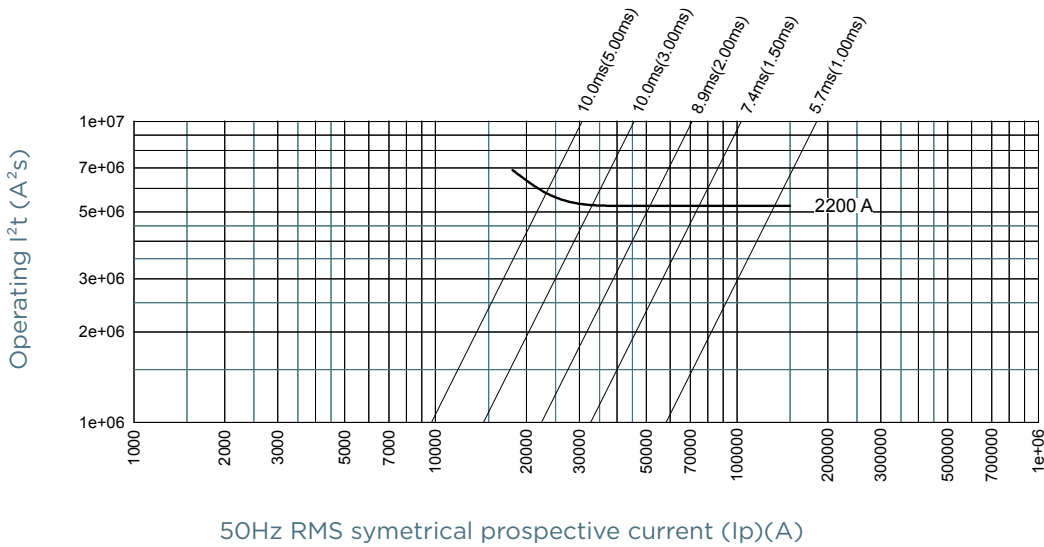

Mersen products have been designed by Mersen for a range of specific applications to be operated depending on particular specification and conditions. Mersen makes no representation or/and warranty, and waives any liability, either express or implied for products' reliability and life time or technical performance in case Mersen has not been provided with customer's specifications or if the products are not purchased directly from Mersen or its distributors and/or agents.

Protistor® size 2x32 and 2x33 aR

400 to 690VAC (IEC) / 700VAC (UL)

CHARACTERISTICS TOTAL I²T CURVE

Size 2x32 690V

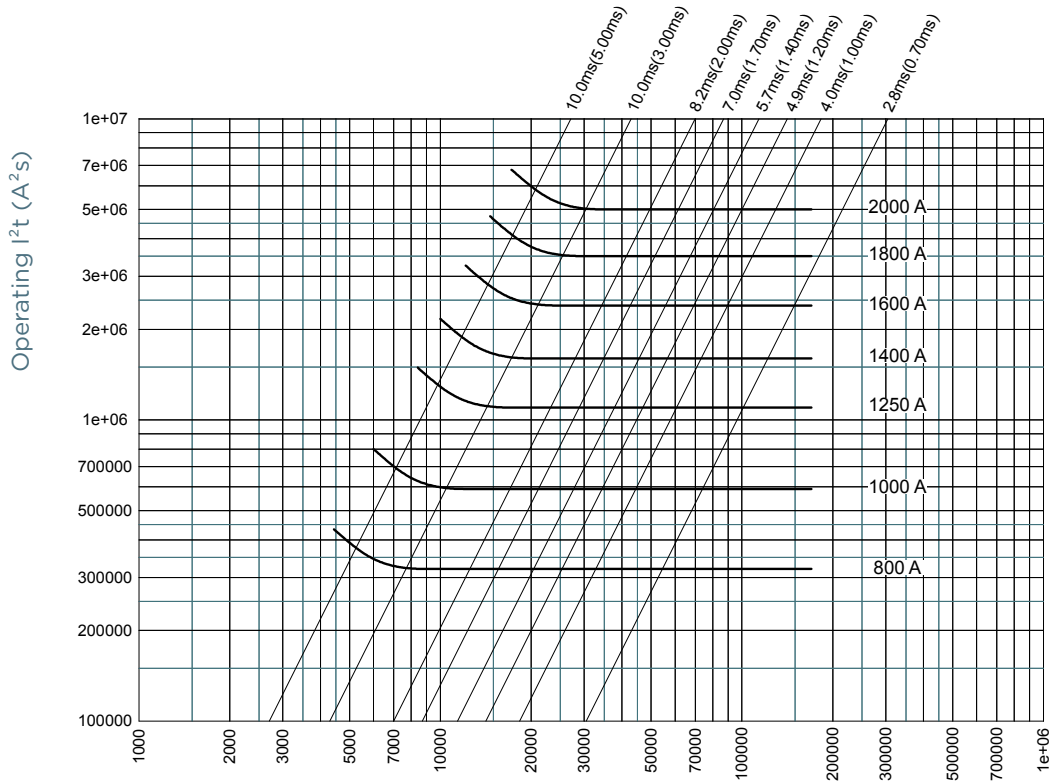

Size 2x33 400V

50Hz RMS symmetrical prospective current (Ip)(A)

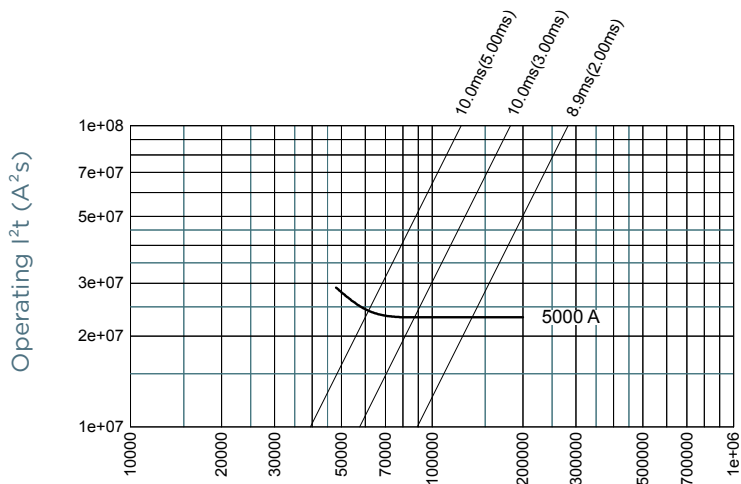

50Hz RMS symmetrical prospective current (Ip)(A)

Mersen products have been designed by Mersen for a range of specific applications to be operated depending on particular specification and conditions. Mersen makes no representation or/and warranty, and waives any liability, either express or implied for products' reliability and life time or technical performance in case Mersen has not been provided with customer's specifications or if the products are not purchased directly from Mersen or its distributors and/or agents.

Protistor® size 2x32 and 2x33 aR

400 to 690VAC (IEC) / 700VAC (UL)

CHARACTERISTICS TOTAL I²T CURVE

Size 2x33 600V

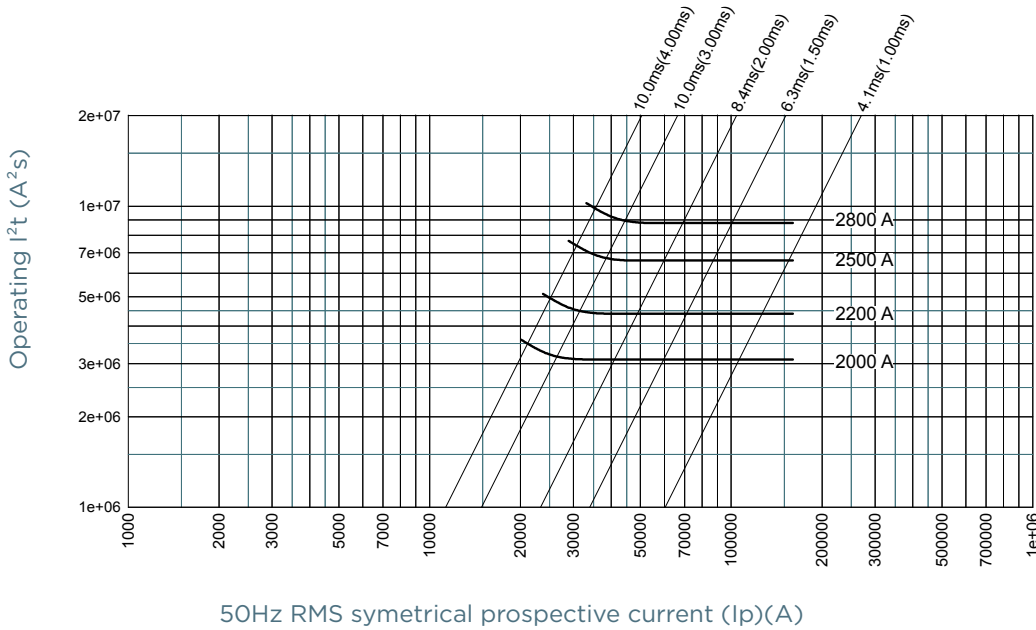

Size 2x33 690V

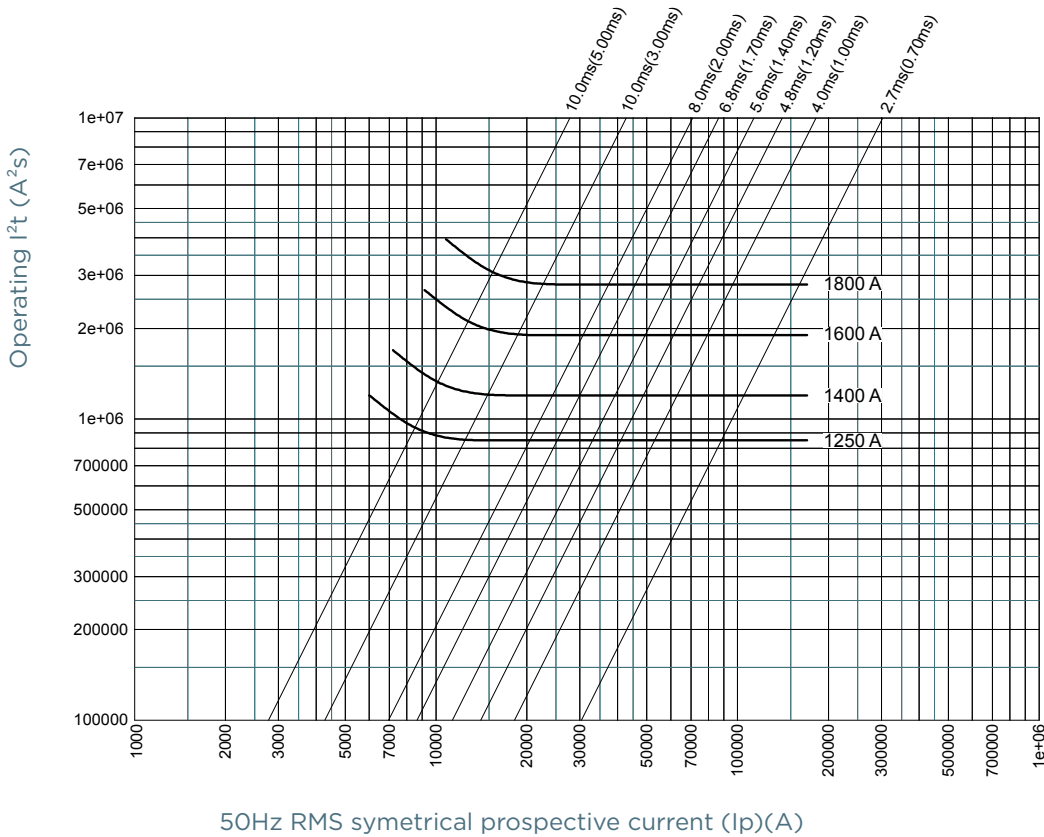

Mersen products have been designed by Mersen for a range of specific applications to be operated depending on particular specification and conditions. Mersen makes no representation or/and warranty, and waives any liability, either express or implied, for products' reliability and life time or technical performance in case Mersen has not been provided with customer's specifications or if the products are not purchased directly from Mersen or its distributors and/or agents.

Protistor® size 2x32 and 2x33 aR

400 to 690VAC (IEC) / 700VAC (UL)

POWER DISSIPATION

Size 2x32

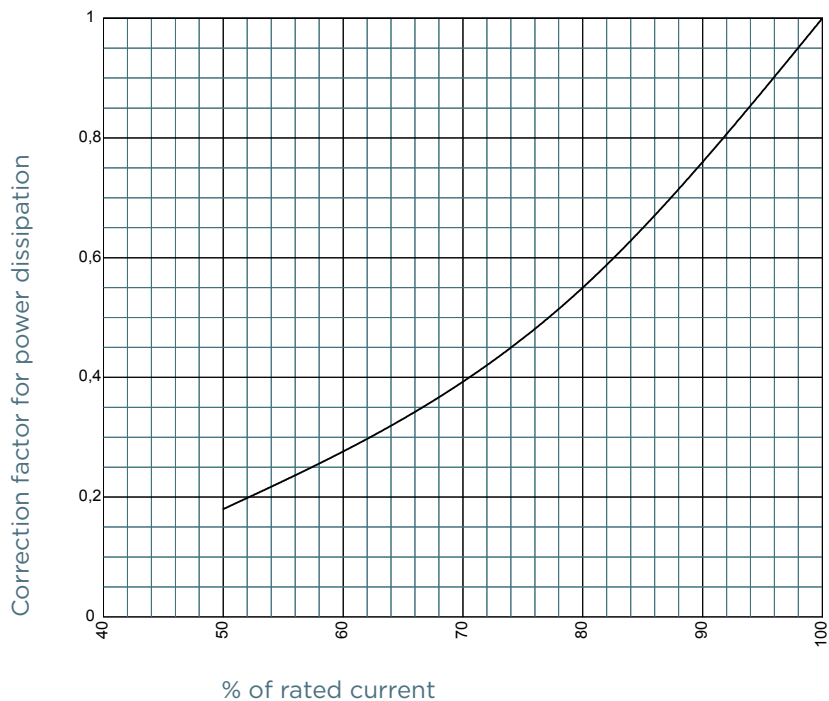

Size 2x33

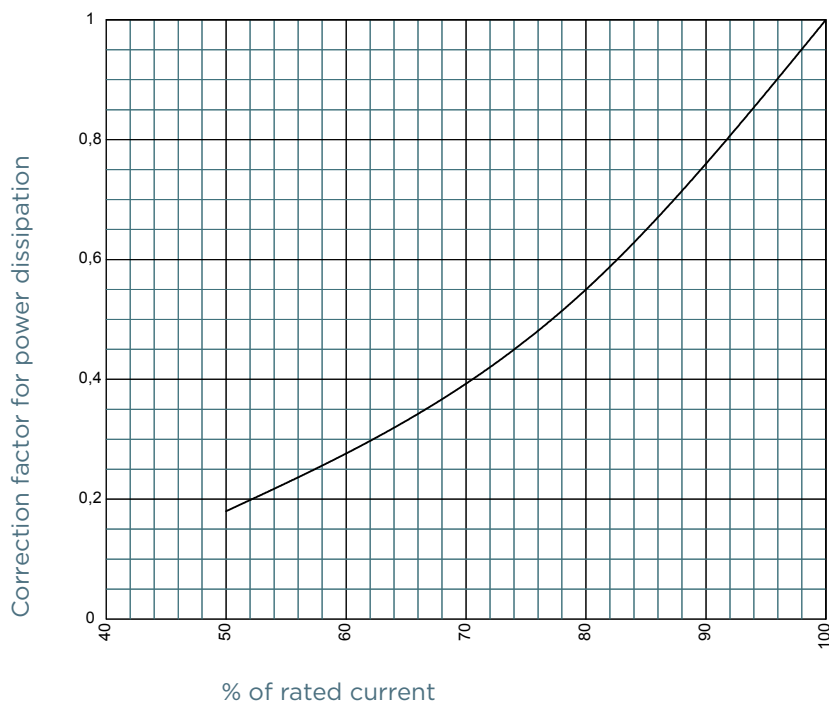

Mersen products have been designed by Mersen for a range of specific applications to be operated depending on particular specification and conditions. Mersen makes no representation or/and warranty, and waives any liability, either express or implied for products' reliability and life time or technical performance in case Mersen has not been provided with customer's specifications or if the products are not purchased directly from Mersen or its distributors and/or agents.

Protistor® size 2x32 and 2x33 aR

400 to 690VAC (IEC) / 700VAC (UL)

PEAK ARC VOLTAGE

Size 2x32

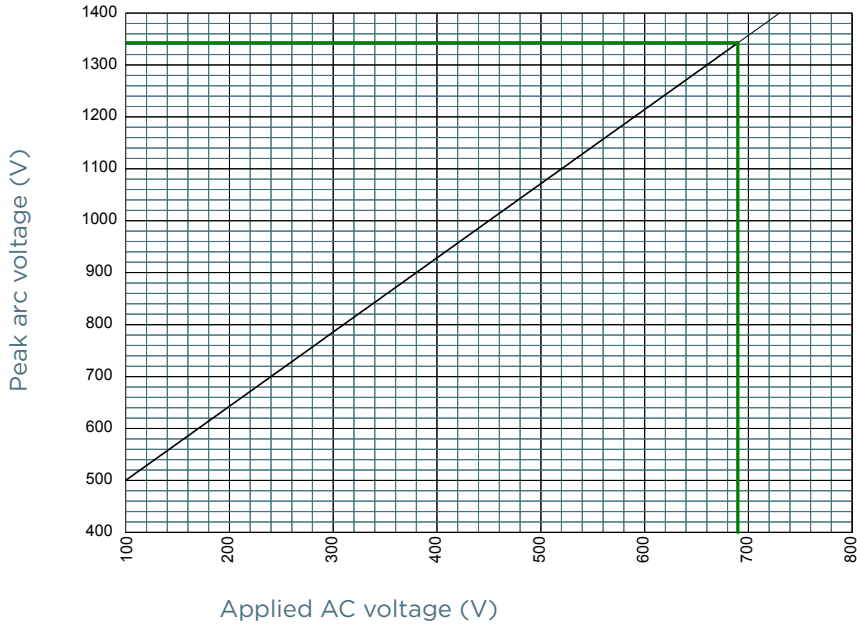

Size 2x33

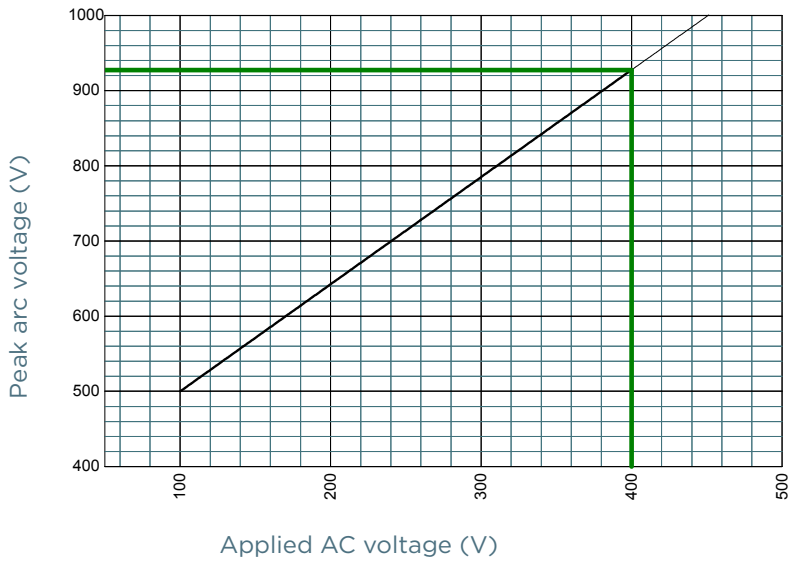

Mersen products have been designed by Mersen for a range of specific applications to be operated depending on particular specification and conditions. Mersen makes no representation or/and warranty, and waives any liability, either express or implied for products' reliability and life time or technical performance in case Mersen has not been provided with customer's specifications or if the products are not purchased directly from Mersen or its distributors and/or agents.

Protistor® size 2x32 and 2x33 aR

400 to 690VAC (IEC) / 700VAC (UL)

DIMENSIONS

Size 2x32 aR TTF (102654)

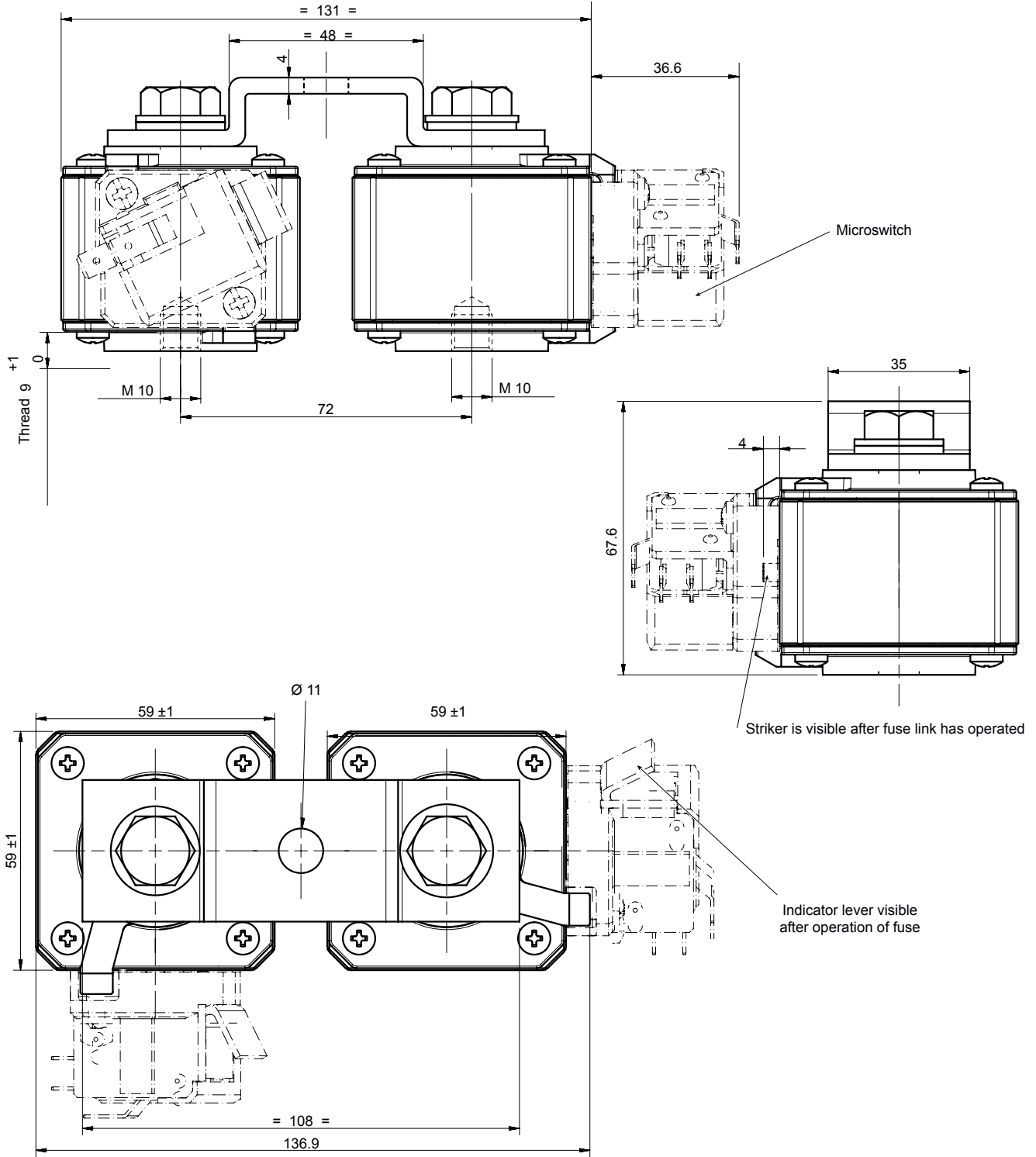

Dimensions in mm

Protistor® size 2x32 and 2x33 aR

400 to 690VAC (IEC) / 700VAC (UL)

DIMENSIONS

Size 2x33 aR PLxF (105252)

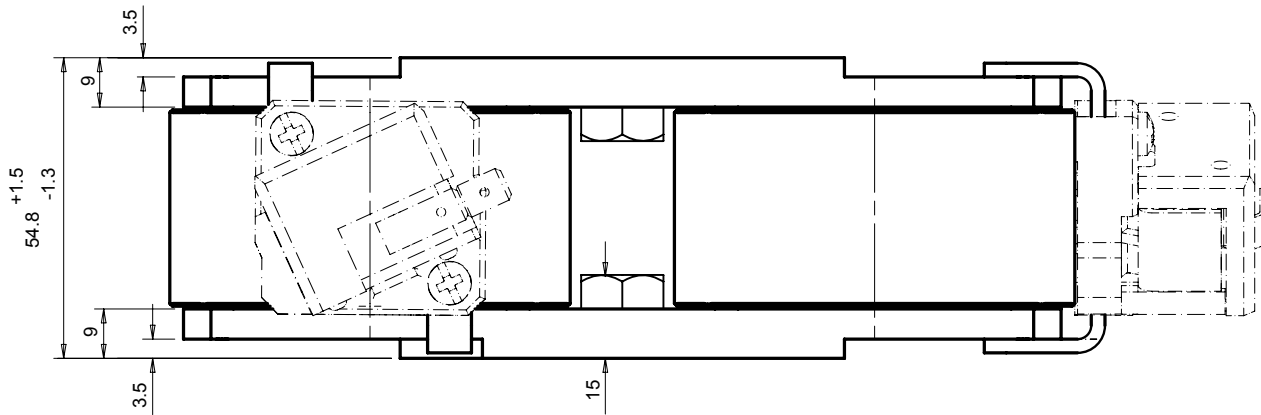
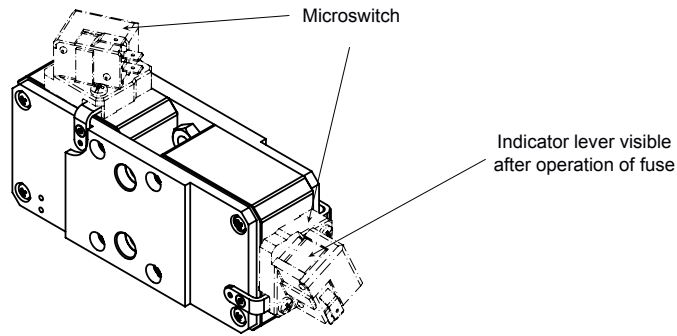
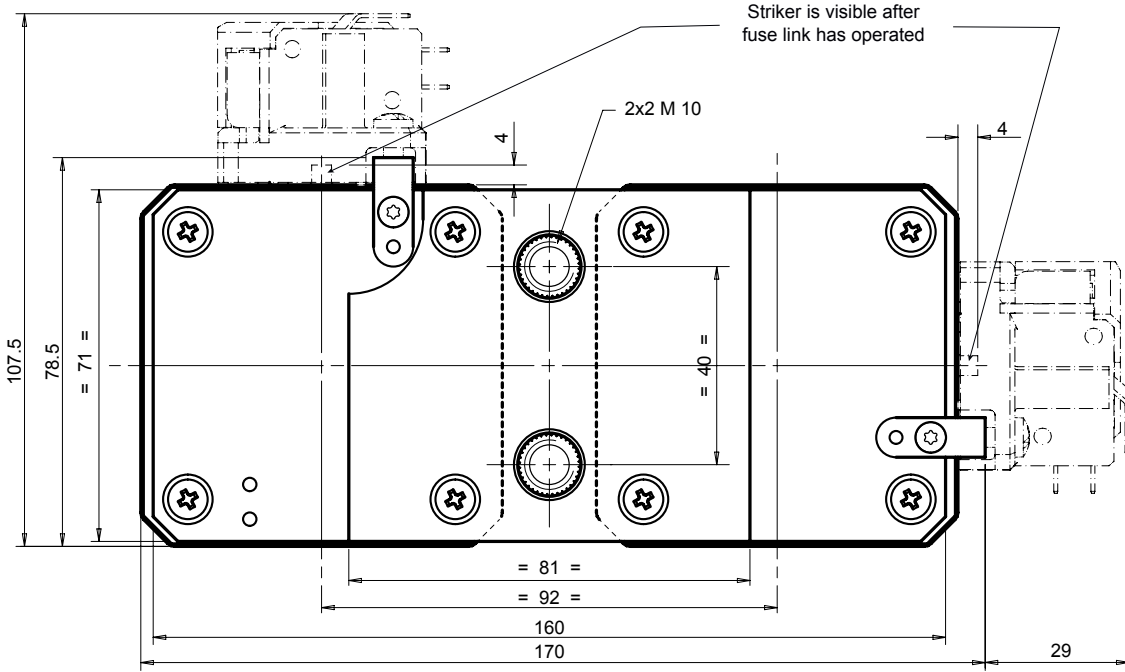

Dimensions in mm

Mersen products have been designed by Mersen for a range of specific applications to be operated depending on particular specification and conditions. Mersen makes no representation or/and warranty, and waives any liability, either express or implied for products' reliability and life time or technical performance in case Mersen has not been provided with customer's specifications or if the products are not purchased directly from Mersen or its distributors and/or agents.

Protistor® size 2x32 and 2x33 aR

400 to 690VAC (IEC) / 700VAC (UL)

DIMENSIONS

Size 2x33 aR TTF (102653)

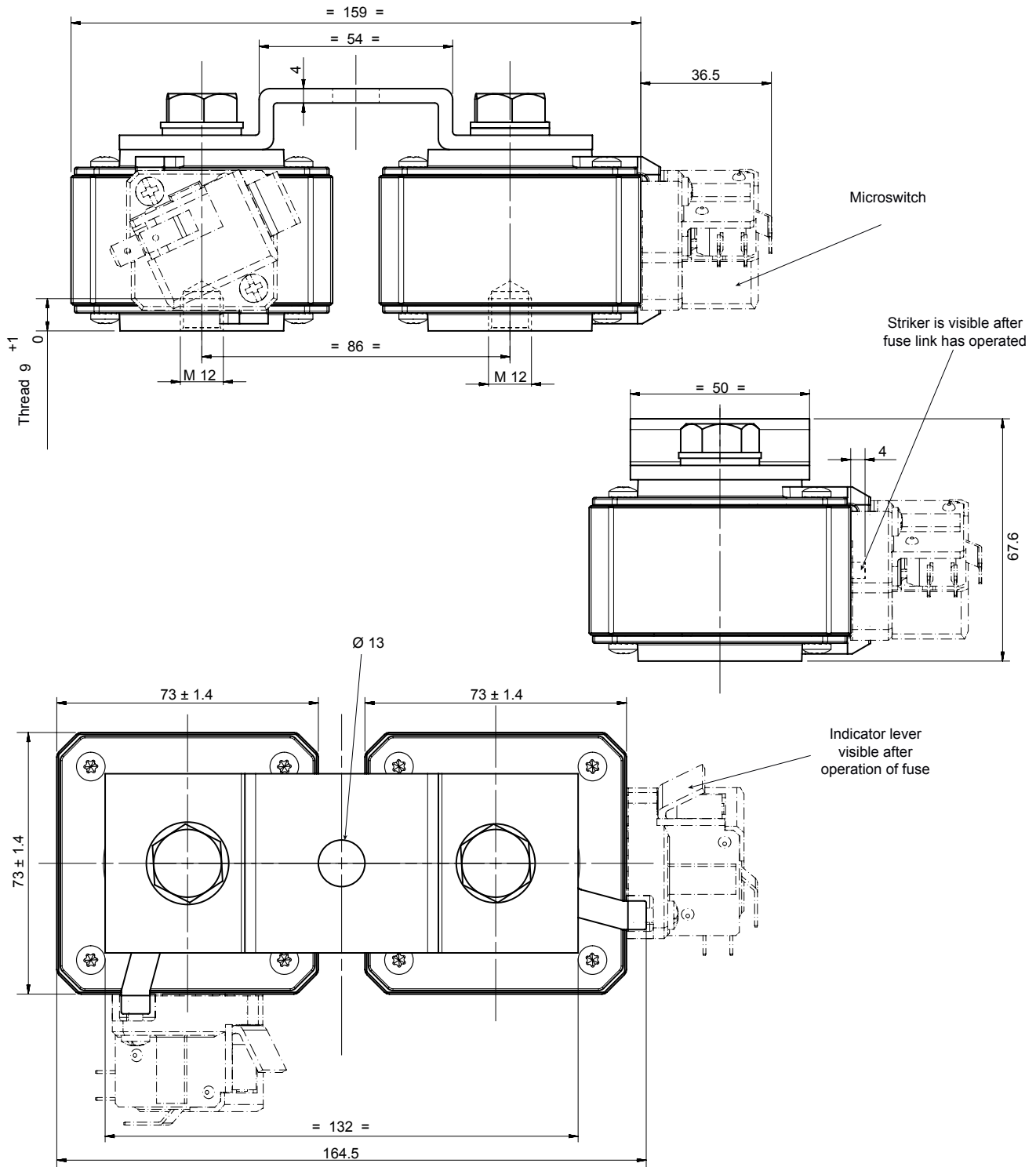

Dimensions in mm

Mersen products have been designed by Mersen for a range of specific applications to be operated depending on particular specification and conditions. Mersen makes no representation or/and warranty, and waives any liability, either express or implied for products' reliability and life time or technical performance in case Mersen has not been provided with customer's specifications or if the products are not purchased directly from Mersen or its distributors and/or agents.

Protistor® size 2x32 and 2x33 aR

400 to 690VAC (IEC) / 700VAC (UL)

APPENDIX

Index

Catalog number	Item number	Description 1	Page
PC232UD69V8CTF	T300305	6,9 URD 232 TT F 0800	2
PC232UD69V10CTF	T300213	6,9 URD 232 TT F 1000	2
PC232UD69V13CTF	V300214	6,9 URD 232 TT F 1250	2
PC232UD69V14CTF	G300087	6,9 URD 232 TT F 1400	2
PC233UD60V20CTF	H1027693	6 URD 233 TT F 2000	2
PC233UD60V22CTF	J1027694	6 URD 233 TT F 2200	2
PC233UD60V25CTF	X302217	6 URD 233 TT F 2500	2
PC233UD60V28CTF	J232745	6 URD 233 TT F 2800	2
PC233UD69V13CTF	D300268	6,9 URD 233 TT F 1250	2
PC233UD69V14CTF	E300269	6,9 URD 233 TT F 1400	2
PC233UD69V16CTF	F300270	6,9 URD 233 TT F 1600	2
PC233UD69V18CTF	W1069036	6,9 URD 233 TT F 1800 BS	2
PC36UD69V18CP11	B300427	6,9 URD 233 PLAF 1800	2
PC36UD60V20CP11	R302235	6 URD 233 PLAF 2000	2
PC36UD60V22CP11	Q302234	6 URD 233 PLAF 2200	2
PC36UD60V25CP11	P302233	6 URD 233 PLAF 2500	2
PC36UD60V28CP11	N302232	6 URD 233 PLAF 2800	2
PC36UD55V30CP11	L301977	5,5 URD 233 PLAF 3000	2
PC36UD55V32CP11	M301978	5,5 URD 233 PLAF 3200	2
PC36UD50V36CP11	N301979	5 URD 233 PLAF 3600	2
PC36UD50V40CP11	P301980	5 URD 233 PLAF 4000	2
PC36UD45V45CP11	Q301981	4,5 URD 233 PLAF 4500	2
PC36UD40V50CP11	R301982	4 URD 233 PLAF 5000	2

Mersen products have been designed by Mersen for a range of specific applications to be operated depending on particular specification and conditions. Mersen makes no representation or/and warranty, and waives any liability, either express or implied for products' reliability and life time or technical performance in case Mersen has not been provided with customer's specifications or if the products are not purchased directly from Mersen or its distributors and/or agents.