

**ALL-PURPOSE CANOPY PARTS LIST.**

 3 PC. CENTER POLE

 2 PC. SIDE POLE

 STEEL STAKE

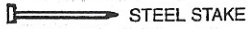

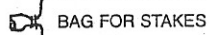
 BAG FOR STAKES

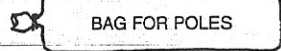
 BAG FOR POLES

**MANPOWER REQUIRED**

Two installers should be able to assemble an All-Purpose Canopy in approximately thirty minutes.

**TOOLS REQUIRED**

Sledge Hammer

**INSPECT SITE CAUTION:**

Consult local utility company prior to installation.

Prior to assembly be sure to look around area for obstacles, pipes, wires, etc.

**LAYOUT & CHECK**

Use parts list for a quick identification and check list for proper quantities.

PARTS	CANOPY SIZE			
	10 x 10	12 x 12 THROUGH 20 x 20	20 x 30	20 x 40
SIDE POLE	4	8	10	12
CENTER POLE	1	1	2	3
STAKES	8	12	14	16
BAG WITH TOP	1	1	1	1
BAG FOR POLES	1	1	1	1
BAG FOR STAKES	1	1	1	1

**2 LAYOUT AT SITE**

20' X 20' canopy used as example. Spread drop cloths and unroll canopy at exact position of desired finished assembly. Any sharp objects which must remain on site under the canopy should be padded and taped. Assemble side poles and lay straight out from each pole hole in canopy. Drive a stake 1'-0" from the end of each pole. The stake must be driven through the ring attached to each guy rope as shown.

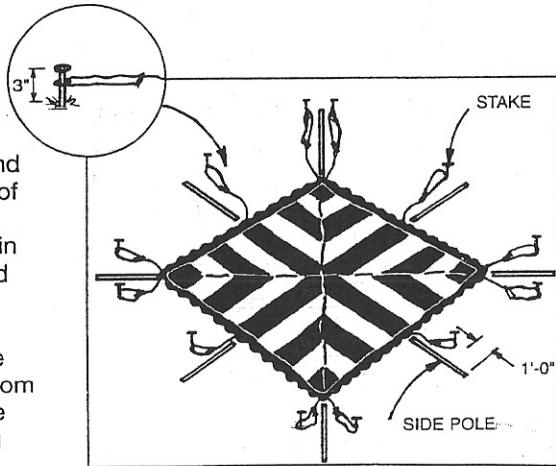

**2 RAISE SIDE POLES**

Start at opposite corners. Insert side poles into pole holes and raise so that bottom of poles slant toward center of canopy.

Adjust guy rope. Continue with other two corners and then sides.

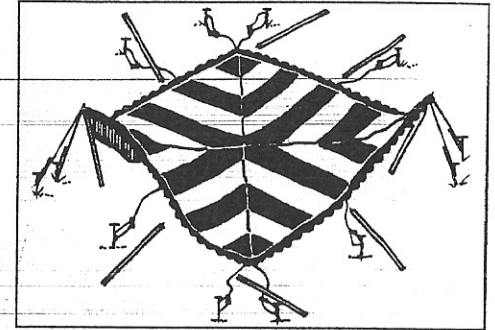

**3 RAISE CENTER POLE**

Assemble three piece center pole and insert into center pole hole.

Raise to upright position and tie off jump rope to pole.

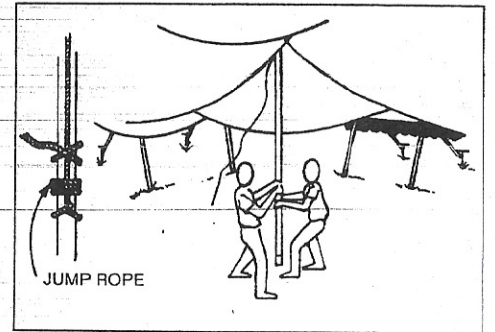

**4 SIDE POLE ADJUSTMENT**

Tighten guy ropes and then set side poles to upright position. Adjust pole positions and guy rope tension to properly pull out canopy.

Protective covers are recommended for all stakes.

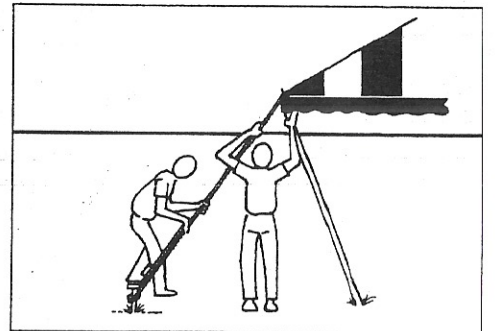

**5 TAKE DOWN**

Loosen all guy ropes. Spread drop cloths. Reverse steps 1 through 4 for disassembly.

**IMPORTANT:**

Check Guys Ropes periodically for tightness and maintaining of good condition. Stakes provided are for average soil conditions. Sandy soil or asphalt may require additional staking. Proper installation suitable to site conditions is the responsibility of the installer. Store canopy in a cool, dry area. Never store while wet or damp.