

# TORO<sup>®</sup>

## RAGE AMPLIFIER



RX2

RX4/RX4S

R2/R3/R4/R5/R6

R4F

### RAGE COMPACT CLASS AB/D AMPLIFIER

## Owners Manual

*Please read through this manual to familiarize yourself with your new amplifier. Should your TORO AUDIO mobile amplifier ever require service, you will need to have the original dated receipt.*

# TORO®



Thank you and Congratulations

Thank you for your decision to purchase a TORO AUDIO Rage amplifier! Our Rage amplifiers are the result of extensive engineering, testing, and bullet proof construction. Their versatility enables compatibility with optional signal and audio processors. These high quality MOSFET amplifiers may be configured to allow maximum flexibility in designing different speaker and subwoofer options.

## COMPACT RAGE AMPLIFIERS

Models RX2,RX4,RX4S are Class AB multi channel amplifiers specifically designed for mid-range or mid-bass speakers and sound quality subwoofer systems.

Models R2,R3,R4,R5,R6 are designed specifically for low frequencies and are intended only to power subwoofers.

Model R4F is full range digital amplifier specifically for full range speakers and subwoofers.

It is important that you closely follow the wiring instructions contained in this Owners Manual so that you get the most from your TORO AUDIO Rage amplifier.

### Caution

High powered audio systems in a vehicle are capable of generating higher than "Live concert" levels of sound pressure. Continued exposure to excessively high volume sound levels will cause hearing loss or damage. Also, operation of a motor vehicle while listening to audio equipment at high volume levels may impair your ability to hear external sounds such as horns, warning signals, or emergency vehicles-thus creating a potential traffic hazard. In the interest of safety, TORO AUDIO highly recommends listening at lower volume levels when driving.

# TECHNICAL FEATURES

- Sound Quality Class-A/B Design (R2, RX2, RX4, RX4S)
- High Efficiency Class-D Design for Subwoofers (R3, R4, R5, R6)
- Full Range Digital Design for full Range Speakers and Subwoofer (R4F)
- Built-In Auto Sensing Turn-On Function (Hi-Inputs)
- MOSFET Power Supplies for High Power Output and Best Stability into Low Impedance Loads
- Soft Delay Remote Turn On/Off Circuit Eliminates Pops and Clicks
- Variable Low Pass Electronic Crossover
- Selectable Bass Boost EQ
- Self-Diagnostic Protection Circuit with LED Status Indicator for; Impedance Over-load, Speaker Short Circuit, Thermal Overheating, and DC Output
- 0.5-OHM Stable Operation with Extensive Output Power Increase (R6)
- 2-OHM Stable Operation with Extensive Output Power Increase (R2)
- 1-OHM Stable Operation with Extensive Output Power Increase (R3, R4, R5, R4F)
- Variable Gain Control
- Remote Level Control Port (for optional controller)

## INSTALLATION EXPERIENCE

Installation of TORO AUDIO mobile amplifiers require detailed knowledge of electronic wiring and proper speaker impedance. We strongly recommend installation by an authorized TORO AUDIO dealer or certified MECP installer. This Owners Manual only provides general installation and operation instructions. If you have any reservations about your installation skills, please contact your local TORO AUDIO dealer for assistance. **IMPORTANT: This amplifier is designed for operation in vehicles with 12-Volt negative ground electrical systems only.**

## PREPARING FOR INSTALLATION

**NOTE: The tools listed below may be required for basic installation**

- An electric drill with bits
- Phillips head and standard screwdrivers
- Wire strippers
- Crimping tool
- VOM (electronic volt ohm meter)
- Heat shrink tubing and heat gun
- Soldering iron
- Electronic (Rosen Core not Acid Core) Solder

# INSTALLATION PRECAUTIONS

**NOTE: Proceed only if you are a qualified installer, otherwise; see your Authorized TORO AUDIO Dealer or MECP Certified Installer to professionally install this amplifier. Always wear protective eyewear when using tools.**

- Turn off all stereo and other electrical devices before you begin
- Disconnect the negative (-) lead from your vehicle's battery
- Locate all fuel lines, brake lines, oil lines, and electrical cables when planning the install
- Make sure there is at least 2-inches (5 cm) around the air vents on the amplifier.
- When connecting ground points, make sure all paint is carefully scrapped away from the vehicle's chassis and contact is made with bare metal
- Use a utility knife to trim away fabric from hole locations before drilling or cutting
- When running power cables through sheet metal, be sure to use grommets to properly insulate the metal edges from the wire insulation
- If possible, use tubing through grommets

## MOUNTING THE AMPLIFIER

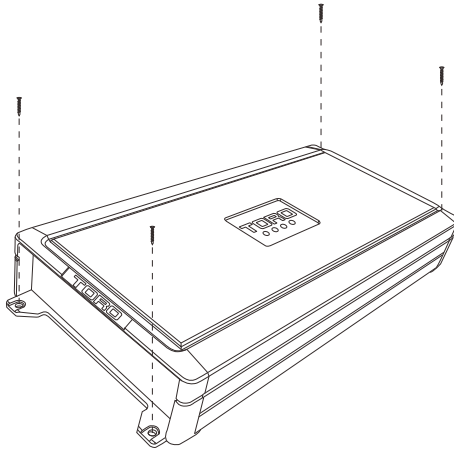

Fig.1 Mounting Amplifier

Due to the high-power output of the TORO AUDIO RAGE amplifiers, considerable heat may be produced when the unit is in operation. For this reason, the amplifier should be mounted in a location which will allow air to circulate freely. A clearance of at least 2-inches (5 cm) to all sides of the amplifier is necessary not only for proper cooling, but also for gaining access to the inputs and other variable controls. Be sure that the power and signal cable connections can enter and leave the amplifier in a straight line to avoid the risk of kinked wires causing malfunction.

## MOUNTING LOCATION

Find a clear and well-ventilated area to mount your amplifier that is unobstructed by any objects that will cause harm or block ventilation. Despite the fact that this amplifier is compact, it still needs air to cool the heat-sink fins. Do not mount under a carpet or an area with dead or stagnant air. Without proper air flow the amplifier may overheat and go into protection where the thermal overload circuitry will shut down the amplifier.

You may use the amplifier as a template and mark the four screw locations with a felt tip pen. Set the amplifier aside before drilling. Use caution to make sure there are no objects behind the installation surface that may become damaged during drilling.

The amplifier should be protected from exposure to moisture and direct sunlight. The best places to mount your amplifier are: The floor of the trunk, under the driver's seat, or on the back of the rear seat. For alternate installation locations, please consult your authorized TORO AUDIO Dealer.

**NOTE: Do not use a drill with driver bit to mount the amplifier. Excessive force could cause the plastic mounting feet to crack.**

### **\*\*\* WARNING \*\*\***

- Upside down mounting will compromise heat dissipation through the heat-sink and could engage the thermal protection circuit.
- Try to avoid mounting the amplifier on a subwoofer enclosure, as extended exposure to vibration may cause malfunction of the amplifier.
- Don't mount the amplifier so that the wire connections are unprotected or are subject to pinching or damage from nearby objects.
- The DC power wire must be fused at the battery positive (+) terminal connection before making or breaking power connections at the amplifier power terminals, disconnect the DC power wire at the battery end.
- The battery of the car audio system must be disconnected until the entire wiring and installation is completed.
- Do not use a power drill to tighten the power, ground, remote or speaker output terminals on the amplifier to avoid stripping the terminal screws. It is best to hand tighten these connections.
- The use of Ring and Spade terminals (not included) provide the best electrical connection for use with the clamp style connections on this amplifier.

# CONTROL PANEL LAYOUT

FIG2 . MONO AMPLIFIER PANEL LAYOUT

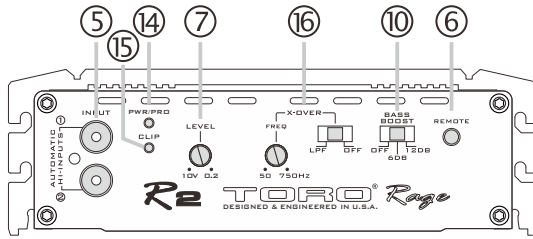

R2

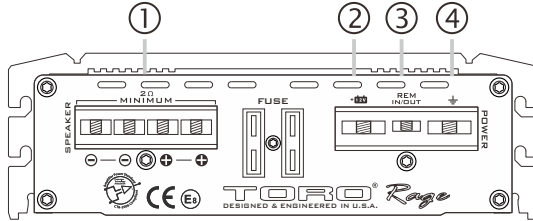

R2

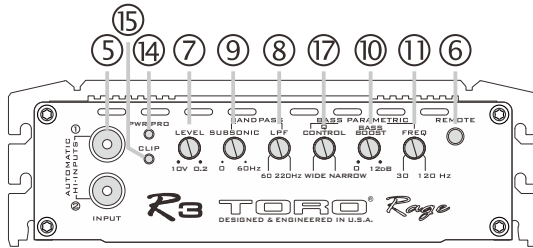

R3/R4/R5/R6

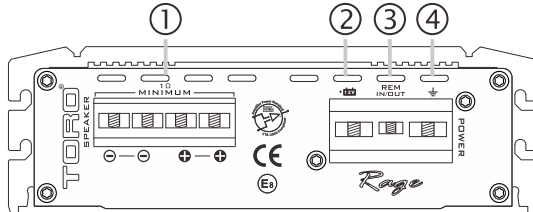

R3/R4/R5/R6

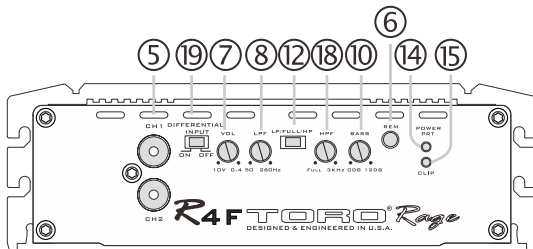

R4F

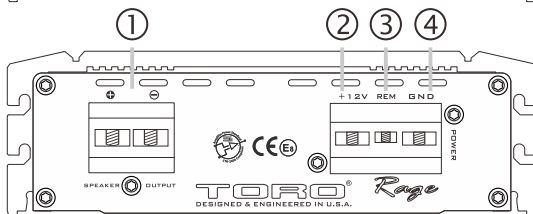

R4F

FIG3 . 4-CH AMPLIFIER PANEL LAYOUT

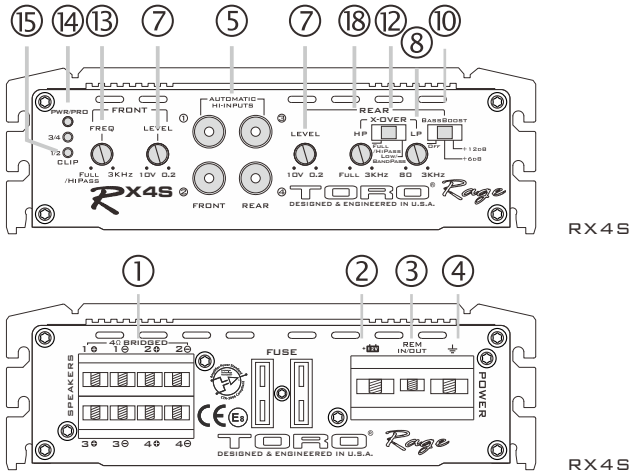
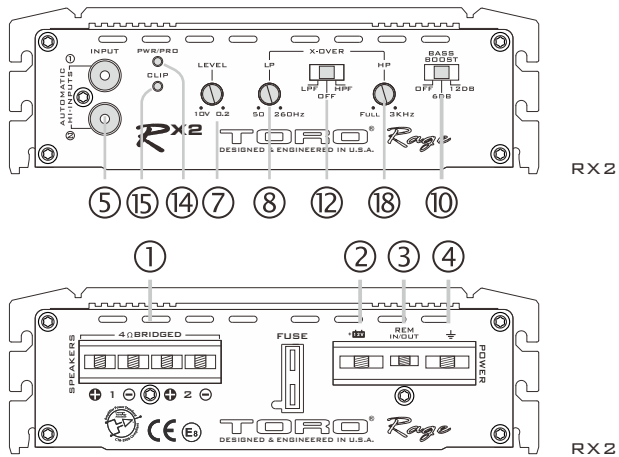

FIG4. 2-CH AMPLIFIER PANEL LAYOUT



## AMPLIFIER FUNCTIONS

### 1. SPEAKERS

CONNECT SPEAKERS/SUBWOOFERS TO THESE TERMINALS. BE SURE TO CHECK WIRE FOR PROPER POLARITY. NEVER CONNECT THE SPEAKER CABLES TO CHASSIS GROUND.

### 2.+12VOLT POWER

CONNECT THIS TERMINAL THROUGH A FUSE CIRCUIT BREAKER TO THE POSITIVE TERMINAL OF THE VEHICLE BATTERY OR THE POSITIVE TERMINAL OF AN ISOLATED AUDIO SYSTEM BATTERY.

### 3. AUTO SENSING TURN ON FUNCTION / REM OUT(HI-INPUTS)

WHEN USE HI-INPUT, THE AMP CAN DETECT THE DC OFFSET FROM THE HIGH-LEVEL INPUT SIGNAL TO AUTO TURN ON/OFF. WHEN THE AMP TURNS ON, THE REM TERMINAL WILL OUTPUT+1.2V DC TO CONTROL THE OTHER DEVICE TURN ON/OFF.

REM IN: WHEN USE LOW LEVEL INPUT, THE AMP REM IN SHOULD BE CONNECTED TO THE REMOTE OUT OF THE SOURCE UNIT. THE HEAD UNIT CONTROLS THE AMP TURN ON/OFF.

#### **4.GND**

CONNECT THIS CABLE DIRECTLY TO THE FRAME OF THE VEHICLE. MAKE SURE THE METAL FRAME HAS BEEN STRIPPED OF ALL PAINT DOWN TO THE BARE METAL. USE THE SHORTEST DISTANCE POSSIBLE. IT IS ALWAYS A GOOD IDEA TO REPLACE THE FACTORY GROUND AT THIS TIME WITH A LARGER CABLE EQUAL TO THE NEW DIRECTLY TO THE VEHICLE BATTERY GROUND TERMINAL OR ANY OTHER FACTORY GROUND POINTS.

#### **5.RCA INPUT/AUTO HI-LOW LINE CONVERTOR**

THESE RCA INPUT JACKS CONNECT WITH YOUR SOURCE UNIT RCA LOW LEVEL OUTPUTS OR VIA OPTIONAL ADAPTER WITH YOUR SOURCE UNIT SPEAKER HIGH LEVEL OUTPUTS. THE USE OF HIGH QUALITY TWISTED PAIR CAR AUDIO CABLES IS RECOMMENDED TO MIND POSSIBILITY OF DISTURBANCE THE AUDIO SIGNAL.

#### **6. REMOTE(MONO BLOCKS)**

CONNECT THE REMOTE CONTROLLER TO CONTROL THE SUBWOOFER AMPLIFIER VOLUME FROM THE DRIVER SEAT LOCATION, FOR EASE OF ADJUSTMENT DURING PLAYING.

#### **7. GAIN CONTROLLER**

GAIN CONTROL WILL MATCH THE AMPLIFIERS SENSITIVITY TO THE SOURCE UNITS SIGNAL VOLTAGE. THE OPERATING RANGE IS 10V TO 200MV. THIS IS NOT A VOLUME CONTROL!

#### **8.LOW PASS FILTER CONTROL (MONO BLOCK)**

THIS CONTROL IS USED TO SELECT THE DESIRED LOW PASS X-OVER FREQUENCY. THE FREQUENCY CAN BE ADJUSTED FROM 60HZ TO 220HZ FOR ALL BASS MONO MODELS.

#### **9. SUBSONIC FILTER CONTROL (MONO BLOCK)**

THIS CONTROL CAN FILTER OUT UNWANTED LOW FREQUENCY FROM 0HZ (OFF) TO 60HZ. THIS FUNCTION WILL INCREASE THE POWER HANDLING OF YOUR WOOFERS.

#### **10.BASS BOOST LEVEL KNOB (MONO BLOCK)**

THIS CONTROL ADJUSTS THE BOOST LEVEL OF THE BASS BOOST CENTER FREQUENCY. IT CAN BE ADJUSTED FROM 0 TO 12DB. COMBINING WITH BASS BOOST FREQUENCY, YOU CAN ACCURATELY MATCH THE AMPLIFIER PERFORMANCE TO WOOFER RESPONSE.

#### **11.BASS BOOST FREQ KNOB (MONO BLOCK)**

THIS CONTROLS THE BOOSTED CENTER FREQUENCY. THE FREQUENCY CAN BE ADJUSTED FROM 30HZ TO 120HZ ACCORDING TO YOUR CAR AUDIO SYSTEM PERFORMANCE. (I.E. WHEN YOU ADJUST THIS KNOB TO 50HZ, THE AMPLIFIER WILL BOOST THE FREQUENCY AROUND 50HZ.) THIS FUNCTION SHOULD BE ADJUSTED COMBINING WITH BASS BOOST LEVEL TUNING.

#### **12. X-OVER MODE (FULL RANGE)**

TO ADJUST THE OPERATING FREQUENCY RANGE OF THE AMP. WHEN SWITCHED TO LPF OR HPF, THE CORRESPONDING FILTER CAN ADJUST THE OPERATING FREQUENCY RANGE. WHEN PUSHING THE SUBWOOFER, SWITCH TO LPF MODE. WHEN PUSHING SMALL CALIBER FULL FREQUENCY SPEAKERS OR MIDDLE AND HIGH FREQUENCY LOUDSPEAKERS, SWITCH TO HPF MODE. WHEN PUSHING LARGE CALIBER FULL FREQUENCY SPEAKERS, SWITCH TO FULL MODE. WHEN SWITCHED TO FULL MODE THE FILTERS WILL NOT FUNCTION.

#### **13. FREQUENCY CONTROL (RX4/RX4S)**

TO ADJUST FRONT FREQUENCY FROM FULL / HI PASS TO 3KHZ.

#### **14.POWER PROTECTION INDICATOR**

THIS LED WILL LIGHT UP WHEN AMPLIFIER WORKS PROPERLY.

THIS RED LED WILL LIGHT UP AND WILL BE FLASHING IF THERE IS A FAULT PRESENTED TO THE AMPLIFIER. PLEASE DISCONNECT THE AMPLIFIER AND RESOLVE THE FAULT BEFORE RECONNECTING THE AMPLIFIER.

#### **15. CLIP**

LED INDICATOR IS TO SHOW SIGNAL CLIPPING, IF THE INPUT SIGNAL WAVE IS BEYOND THE RANGE.

BY LOWERING THE GAIN, THE CLIPPED PORTION WILL GO BACK WITHIN THE INPUT RANGE AND THE LED INDICATOR WILL TURN OFF.

OCCASIONAL LED "ON" ( OCCASIONAL FLICKERING) OF LED WOULD BE PERMISSIBLE IN SOME INSTALLS, BASED ON PERSONAL PREFERENCE.

#### **16.CROSSOVER**

THIS CROSSOVER SWITCH SELECTS (LPF) LOW PASS FREQUENCIES. THE OFF POSITION IS FOR FULL RANGE. THE CROSSOVER FREQUENCY RANGE TO SELECT THE LOW PASS FREQUENCY (LPF) IS BASED ON YOUR SPEAKERS AND SYSTEM SETUP REQUIREMENTS



### 17.Q CONTROL (WIDE AND NARROW) FOR R4, R5, R6

USED TO CONTROL THE FREQUENCY BAND WIDTH (I.E.) WIDE WILL EFFECT MORE FREQUENCIES AND NARROW EFFECTS LESS FREQUENCIES.

### 18.HIGH PASS FILTER

SWITCH THE (HP) HIGH PASS FREQUENCY SWITCH FOR HIGH PASS FREQUENCY SET UP FROM FULL RANGE UP TO 3 KHZ BASED ON YOUR SPEAKERS AND SYSTEM SETUP REQUIREMENTS. SWITCH TO LOW/BAND PASS FOR A VERSATILE BANDPASS SET UP FROM 20HZ TO 3KHZ OR SIMPLY A LOW PASS SET UP FOR SUBWOOFERS WITH SUB SONIC CONTROL.

### 19.DIFFERENTIAL INPUT SWITCH

SWITCH THE DIFFERENTIAL INPUT SWITCH IN CASE OF THE NOISE FROM INSTALLTION

## POWER WIRING AND SIGNAL CONNECTIONS

### \*\*\* WARNING \*\*\*

**Disconnect the negative (-) battery terminal before you start any wiring work! The battery of your car audio system must be disconnected until the entire wiring installation is completed.**

TORO AUDIO Rage Mono Block amplifiers will draw large levels of current, so use the largest gauge power / ground cable possible. Using too small of a power cable can result in unnecessary over-heating of the amplifier, distortion at high volume levels and might even cause the thermal protection circuitry to shut-off the amplifier. Remember, bigger wire and pure copper is better! For the best results we recommend a 100% Pure Copper amplifier install kit available at your local TORO AUDIO dealer

- Use rubber grommets when running cables through any metal or sharp plastic, to prevent accidental shorting or shearing. Make sure the cables do not interfere with the normal operation of the vehicle
- The audio signal cables (RCA Cables) should be kept far away from any potential sources of electrical interference such as electronic vehicle management systems, relays, engine computers wiring harnesses, fuel pumps etc.

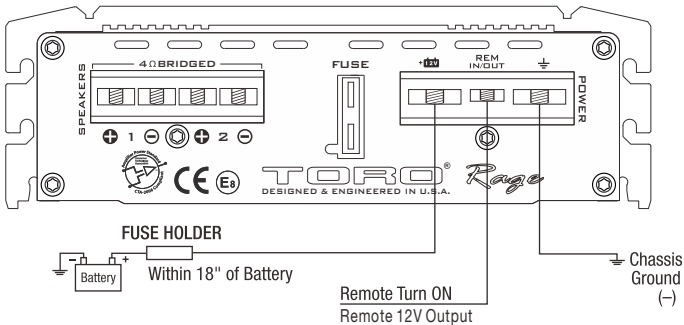

FIG5. Power Input Connection

This amplifier is designed to work within a 9 to 16 volt DC range. Before any wires are connected, the vehicles electrical system should be checked for correct voltage supply with the help of a voltmeter.

First, check the voltage at the battery with the ignition in the OFF position. The voltmeter should read no less than 12V. If your vehicles electrical system is not up to these specifications, we recommend having it checked by an auto electrician before any further installation. Once the vehicle is checked, make certain the correct cable gauge is used. We recommend using as large a gauge cable as possible, use the Power Cable Selection Chart to calculate the correct power wire size for your application. Remember Bigger is Better!

## 12V(Power)

This amplifier should be wired directly to the vehicle battery using the appropriate size cable. Start at the vehicle battery and run the power cable through to the amplifier. Avoid running the power cable over engine components and near heater cores. **The use of an in-line fuse or circuit breaker is a must;** this will prevent the risk of a potential fire caused by a short in your power cable. Connect the fuse holder or circuit breaker as close to the battery positive (+) terminal as possible (no farther than 18" from that battery). This fuse or circuit breaker should be no greater than the sum of the fuses found on the chassis of your amplifier (also see specifications chart). You may now connect the cable to the battery, but remember to leave the fuse out or circuit breaker "off" until all other cable connections are made.

## GND(Ground)

When grounding your amplifier, locate a metal area close to the amplifier that is good source of ground (preferably the floor pan). Once again, investigate the area you wish to use for electrical wires, vacuum lines, and brake or fuel lines. Use either a wire brush or sandpaper to eliminate unwanted paint for better contact of the ground.

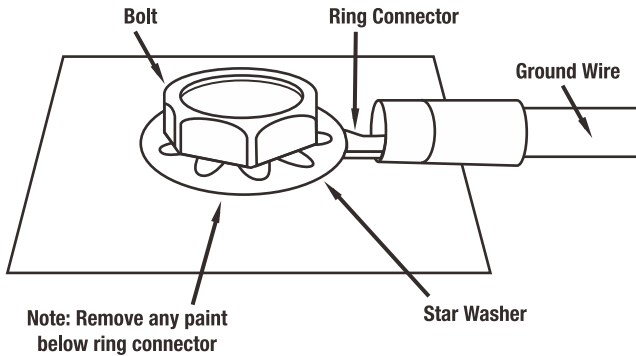

**Now it's time to connect the power and ground cables to the amplifier.** Cut both cables to length. Use a Phillips screwdriver to loosen the BATT+ and the GND connections on the amplifier. Insert the ground first, and then the +12V and please make sure that you place them into the correctly marked terminals. Then tighten the screws down securely.

## REM (Remote Trigger)

This terminal must be connected to a switched +12V source. Typically, remote turn-on leads are provided at the source unit that will turn on and off the amplifier in correspondence with the source. If the source unit does not have a remote turn-on lead, then a switched +12V supply must be used, like the ACC,+12V.

Run a minimum of 18-gauge wire from the amplifier location to the source of the switched +12V lead. If possible, route this wire on the same side of the vehicle as your power cable. Connect the source remote output to the wire. Go back to the amplifier and cut the wire to length. Loosen the screw terminal marked REM on the amplifier

## FUSE REQUIREMENTS

While the panel on your TORO AUDIO amplifier incorporates one or more fuses, these do nothing to protect the vehicle from a dangerous short circuit. It is absolutely vital that the main power lead to the amplifier(s) in the system be fused within 18-inches(45cm) of the connection to the vehicle battery. The value of this fuse (or circuit breaker) should be no greater than the sum of the fuses found on all of the equipment being connected to that power wire.

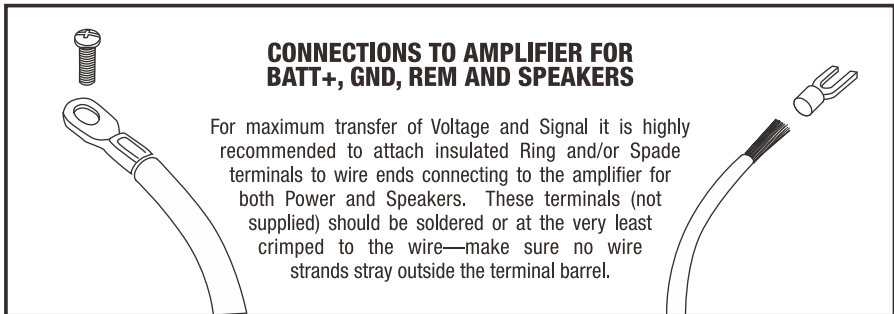

**NOTE: It is highly recommended that a hand screw driver and NOT a power drill is used to tighten the screws on the terminal blocks. This will prevent stripping or other possible damage to the amplifier.**

# RCA INTERCONNECT WIRING

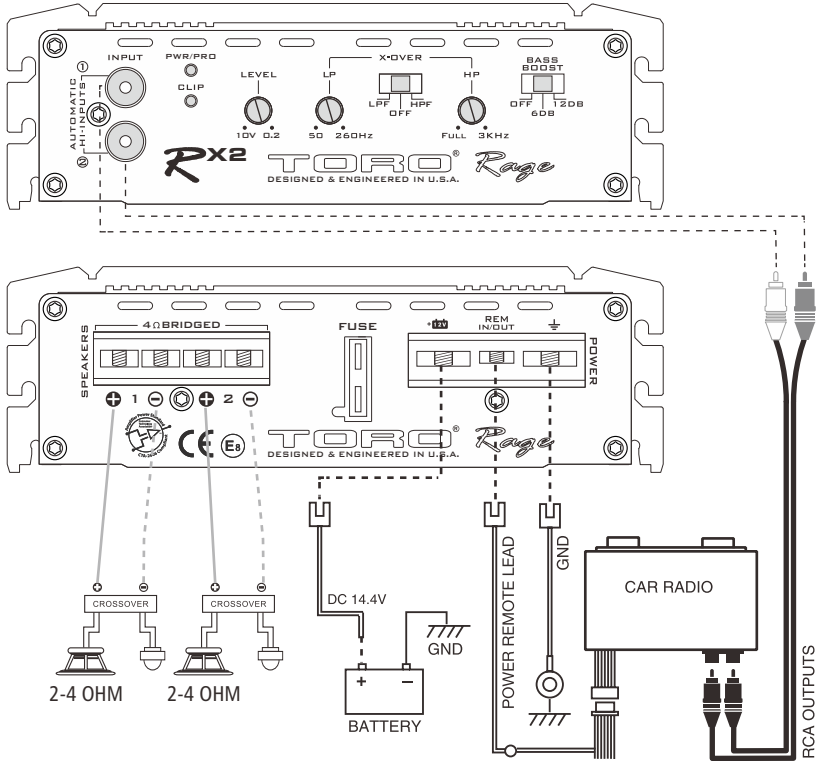

FIG6. Low Level Input using RCA

Choose the correct length and style of RCA interconnects for your needs. Always use high quality RCA audio cables (not supplied) for signal connections--those with multiple layers of shielding or a twisted pair variety provides better noise rejection.

Be extra careful when routing your RCA audio interconnect cables. Car environments are notorious for poorly insulated wires. This means that hiss, engine noise, and fan noise can easily be picked up through RCA cables if run incorrectly.

Make sure that the cables for power and audio signal are not on the same side of the vehicle and that they do not cross each other; this will help reduce any noise that may radiate from the power cable and the signal cable. If an audio cable is too close to a power cable, it may pick up the magnetic field generated by the power cable, which could lead to a loss of quality in your signal.

# WIRING DIAGRAM

FIG7. MONO AMPLIFIER WIRING (SINGLE WOOFER LOAD)

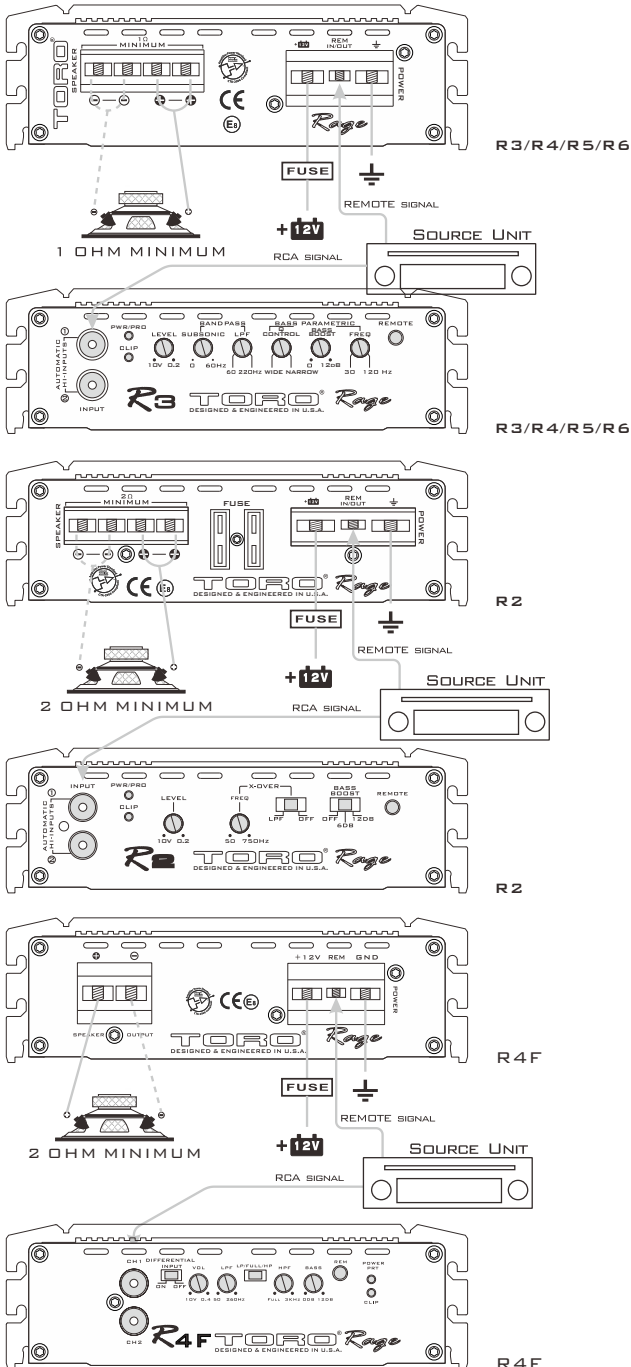
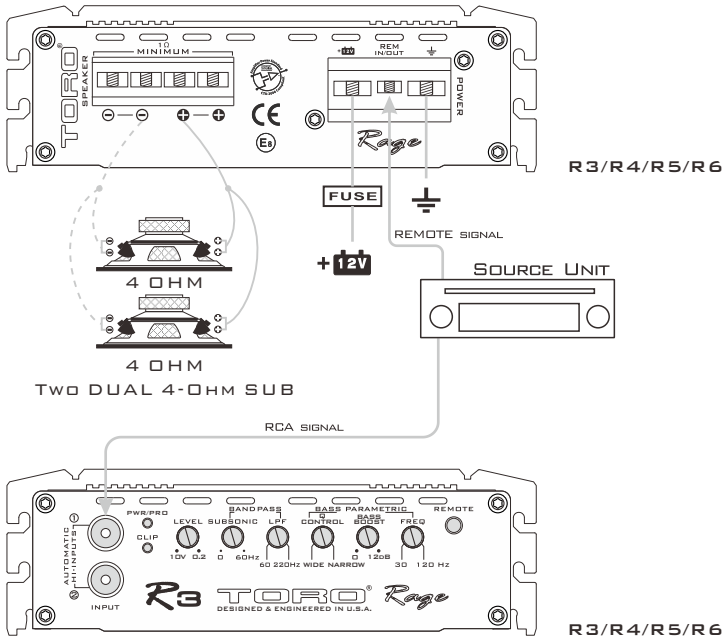

FIG8. MONO AMPLIFIER WIRING (MULTI-WOOFER LOAD)



\*EQUIVALENT PARALLEL WOOFER LOADS CANNOT BE LESS THAN THE MINIMUM STABLE LOAD RATED IN THIS MANUAL. THE TWO NEGATIVE AND TWO POSITIVE SPEAKER TERMINALS ARE WIRED INTERNALLY INSIDE EACH AMPLIFIER.

ONLY ONE NEGATIVE AND ONE POSITIVE ARE NEEDED WHEN WIRING TO THE AMPLIFIER.

THESE ARE MONO-BLOCK AMPLIFIERS AND NOT MULTI-CHANNEL AMPLIFIERS.

THE MINIMUM LOAD FOR ALL "MONO RAGE" (MONOBLOCK) AMPLIFIERS ARE 1-OHM, EXCEPT "R2" (2-OHM MINIMUM).

FIG9. RX2 AMPLIFIER WIRING (1-CHANNEL MODE)

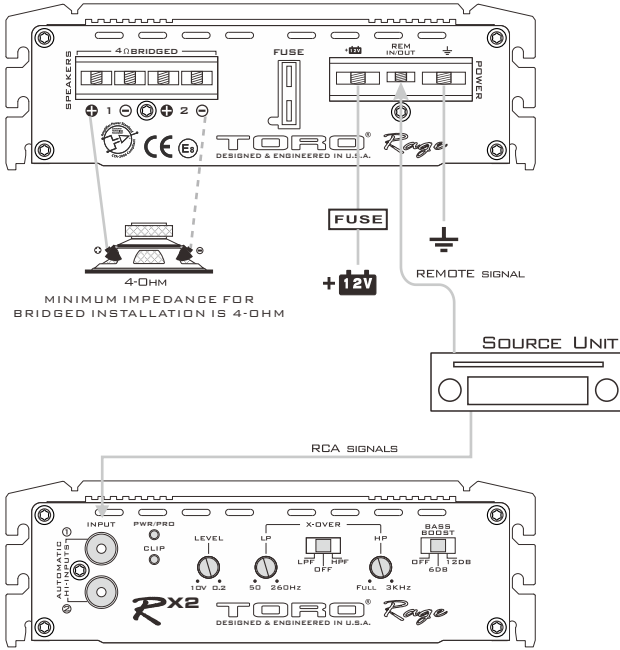

FIG10. RX2 AMPLIFIER WIRING (2-CHANNEL MODE)

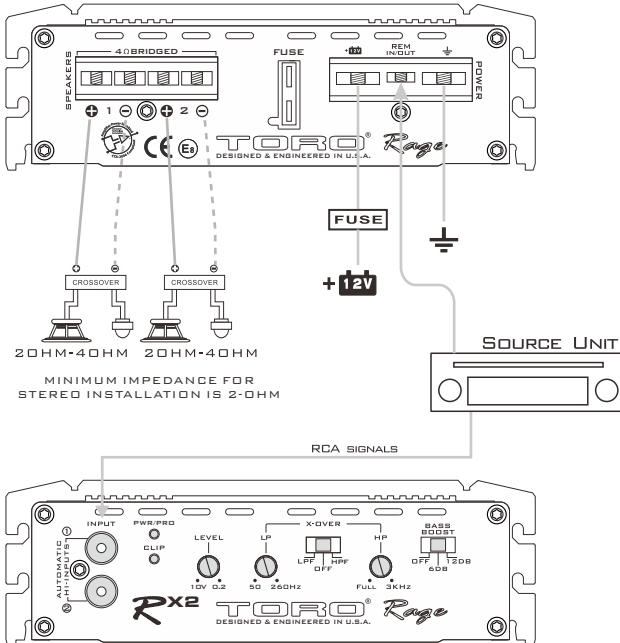

FIG11. RX4/RX4S AMPLIFIER WIRING (3-CHANNEL MODE)

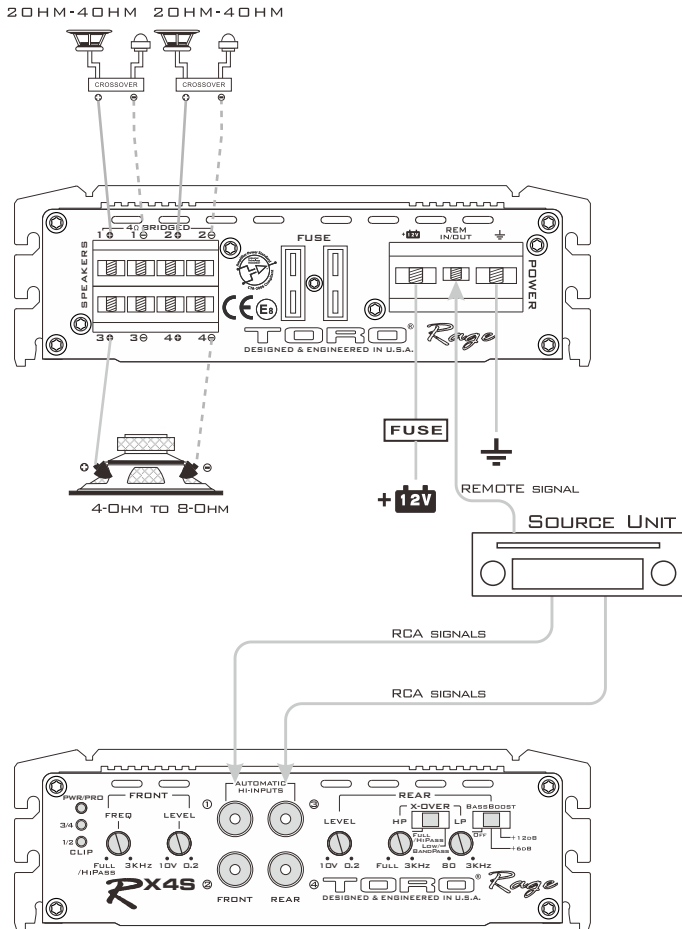
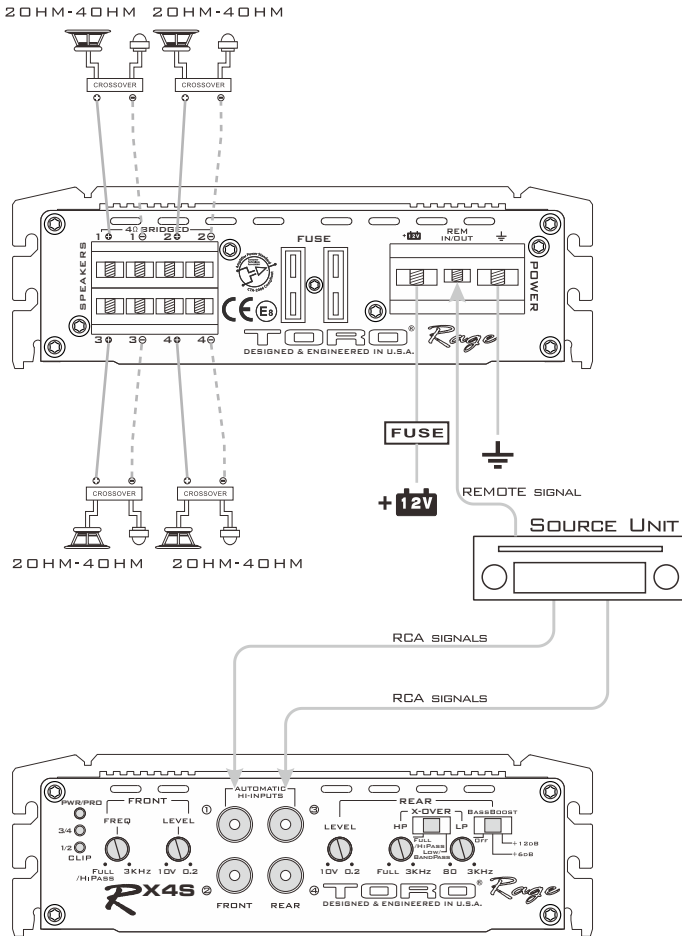



FIG12. RX4/RX45 AMPLIFIER WIRING (4-CHANNEL MODE)



# TROUBLE SHOOTING

Problem	Solution
<b>Power LED not ON</b>	With a Volt Ohm Meter (VOM) check: <ul style="list-style-type: none"> <li>• +12 Volt power terminal (should read +12 to +16VDC)</li> <li>• Remote turn-on terminal (should read +12 to +16VDC)</li> <li>• Ground Terminal</li> </ul>
<b>Power LED lights BLUE, no output</b>	<ul style="list-style-type: none"> <li>• Check RCA connections</li> <li>• Test speaker outputs with known good speaker</li> <li>• Substitute known good Source Unit</li> <li>• Check for signal on the RCA cable with VOM in AC position</li> </ul>
<b>Red Status Protection LED is ON, no output and</b> <b>1. Amp is VERY HOT</b>  <b>2. Amp shuts down ONLY when the vehicle is running</b>  <b>3. Amp plays at very low volume</b>	<ul style="list-style-type: none"> <li>• Thermal protection is engaged. Check for proper impedance at speaker terminals. Also check for adequate air flow around the amplifier.</li> <li>• Voltage protection engaged. Voltage to the amp is not within the 10-16.5 VDC operating range. Have the battery/charging system inspected.</li> <li>• Short circuit protection is engaged. Check for speaker wires shorted to each other or the vehicle chassis. Speakers operating below the minimum impedance can cause this to occur.</li> </ul>
<b>Alternator noise (varies with RPM)</b>	<ul style="list-style-type: none"> <li>• Check for damaged RCA cable.</li> <li>• Check routing of RCA cable</li> <li>• Check Source Unit for good ground</li> <li>• Check amp gain setting, turn down if set too high</li> <li>• Check for chassis Ground short on speakers</li> </ul>
<b>Poor Bass Response</b>	Check woofer polarity, reverse the connection of one speaker only.

**NOTE: If the Status LED is activated and glows RED with no speakers connected to the amplifier, and all the power connections are correct, this would indicate an internal problem with the amplifier. Contact TORO AUDIO USA or your local dealer.**

# RAGE AMPLIFIER SPECIFICATION CHART

MODEL	RX2	RX4	RX4S	R2	R3	R4	R5	R6	R4F	
Description	2ch	4ch	4ch	1ch	1ch	1ch	1ch	1ch	1ch	
Power output @ 14.4VDC Input										
4 Ohm RMS Power (Watt)	2x65	4x65	4x80	1x200	1x200	1x400	1x600	1x750	1x400	
2 Ohm RMS Power (Watt)	2x90	4x90	4x100	1x320	1x380	1x700	1x1100	1x1300	1x700	
1 Ohm RMS Power (Watt)	N/A	N/A	N/A	N/A	1x 550	1x1050	1x1600	1x2300	1x1000	
0.5 Ohm RMS Power (Watt)	N/A	N/A	N/A	N/A	N/A	N/A	N/A	1x3200	N/A	
4 Ohm Bridged Power (Watt)	1x180	2x180	2x200	N/A	N/A	N/A	N/A	N/A	N/A	
Peak Music Power (Watt)	2x250	4x250	4x300	1x1000	1x1500	1x2500	1x4000	1x8000	1x2500	
THD @ RMS Power	<0.05%	<0.05%	<0.05%	<0.5%	<0.8%	<1%	<1%	<1%	<0.3%	
Frequency Response	12Hz-40kHz	14Hz-50kHz	14Hz-50kHz	12Hz-50kHz	13Hz-220Hz	13Hz-220Hz	13Hz-220Hz	13Hz-220Hz	25Hz-18KHz	
S/N Ratio (EIA Rated)	>105dB	>105dB	>105dB	>100dB	>100dB	>100dB	>100dB	>100dB	>90dB	
Input Sensitivity	200mV-10V	200mV-10V	200mV-10V	200mV-10V	200mV-10V	200mV-10V	200mV-10V	200mV-10V	400mV-10V	
Crossover Slope	12dB									
LPF/HPF	50Hz-260Hz/ FULL-3KHz	80Hz-3KHz/ FULL-3KHz	80Hz-3KHz/ FULL-3KHz	50Hz-750Hz	60Hz-220Hz					25Hz-18KHz
SUBSONIC FILTER	N/A	N/A	N/A	N/A	0-60Hz					25Hz-9.1KHz
Bass EQ (on/off)	OFF-6DB -12DB	OFF-6DB -12DB	OFF-6DB -12DB	OFF-6DB -12DB	0 -12DB					
Subwoofer EQ Freq.	N/A	N/A	N/A	N/A	30Hz-120Hz					
Fuses/ ATC Style	25A	50A	60A	50A	60A	100A	120A	200A	90A	
Dimensions (2.0" H x 7.1" W)	7.68"	11.61"	12.56"	11.61"	7.68"	10.83"	13.98"	20.9"	5.82"	
Dimensions (54mm H x 171mm W)	195mm	295mm	319mm	295mm	195mm	275mm	355mm	531mm	148mm	

## TORO AUDIO WARRANTY POLICY

TORO TECH LLC offers limited warranty on TORO AUDIO products under normal use on the following terms:

**TORO AUDIO Amplifiers are to be free of defects in material and workmanship for a period of one(1)year.**

TORO AUDIO Amplifiers are to be free of defects in material and workmanship for a period of 90 days, from the date of purchase, if purchased over the counter from an authorized TORO AUDIO retailer. The Warranty will increase to 1 (one) year if installed by a TORO AUDIO Authorized Installer.

This warranty covers only the original purchaser of TORO AUDIO products. In order to receive service, the purchaser must provide TORO AUDIO with the receipt stating the consumer name, dealer, product and date of purchase.

Products found to be defective during the warranty period will be repaired or replaced (with a product deemed to be equivalent) at TORO AUDIO's discretion and will not be liable for incidental or consequential damages. TORO AUDIO will not warranty this product under the following situations:

- **Amplifiers received with apparent rust or corrosion**
- **Any evidence of liquid damage or exposure to excessive heat**
- **Attempted repairs or alterations of any nature**
- **Product that has not been installed according to this owner's manual**
- **Products that are used beyond normal operating conditions**
- **Products that have blown circuitry due to misuse**

Any implied warranties including warranties of fitness for use and merchantability are limited in duration to the period of the express warranty set forth above. Some states do not allow limitations on the length of an implied warranty, so this limitation may not apply. No person is authorized to TORO AUDIO any other liability in connection with the sale of this product.

TORO TECH LLC.

Residents of HI, AK and US territories will be charged for return shipping. All inquiries regarding service and warranty should be sent to the above address or via email at [support@toroaudio.com](mailto:support@toroaudio.com).

**Removed or altered serial numbers will void this warranty**

[WWW.TOROAUDIO.COM](http://WWW.TOROAUDIO.COM)

MANUFACTURED BY TORO TECH LLC.  
DESIGNED IN U.S.A.

V.050809