

PREMIUM .5" x 4.125" CURVED DIELINE (4g Jar)

- BLEED
- DIELINE
- FOLD LINE
- SAFE ZONE
- SEAL AREA
- BLANK AREA

#4

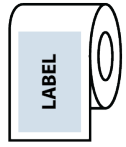

Left Side First

Left side of label will come off the roll first

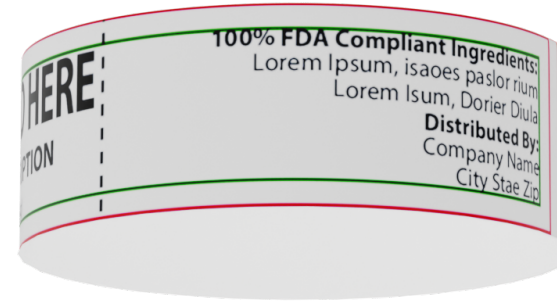
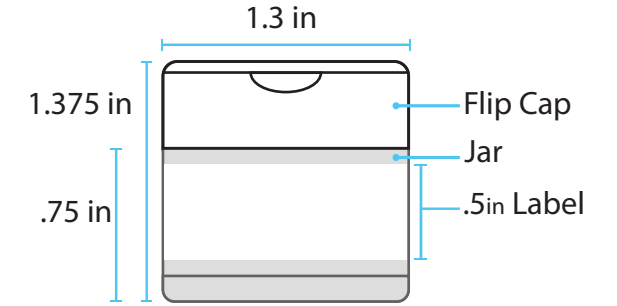
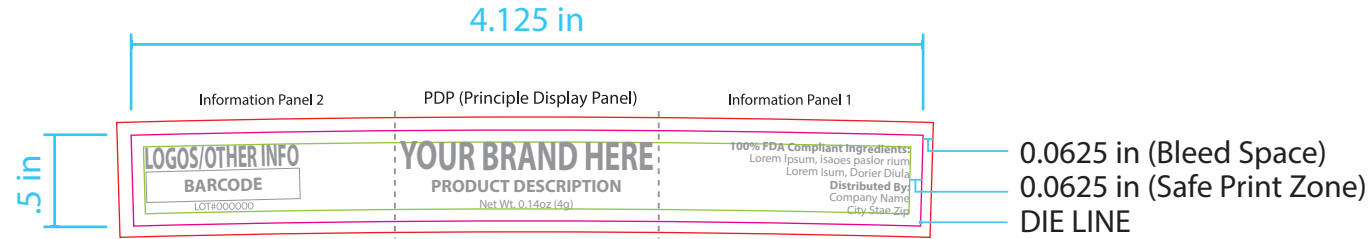

Rendered Label

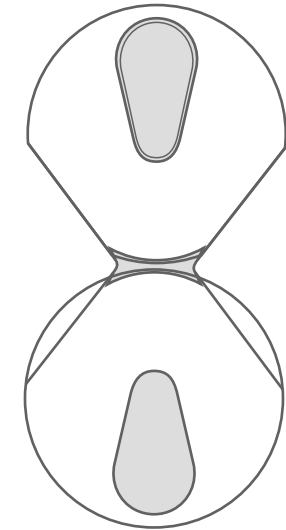

1.375in
Flip Cap

PREMIUM .5" x 4.125" CURVED DIELINE (4g Jar)



- BLEED 
- DIELINE 
- FOLD LINE 
- SAFE ZONE 
- SEAL AREA 
- BLANK AREA 

#4

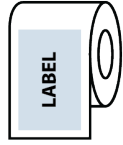

Left Side First

Left side of label will come off the roll first

LOGOS/OTHER INFO BARCODE LOF000000	YOUR BRAND HERE PRODUCT DESCRIPTION Net Wt. 0.14oz (4g)	100% FDA Compliant Ingredients: Lorem Ipsum, isaeos paslor nium Lorem Ipsum, Dorier Diula Distributed By: Company Name City, State, Zip
--	---	--

PREMIUM .5" x 4" STRAIGHT DIELINE (4g Jar)

- BLEED —
- DIELINE —
- FOLD LINE - - -
- SAFE ZONE —
- SEAL AREA
- BLANK AREA

#4

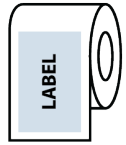

Left Side First

Left side of label will come off the roll first

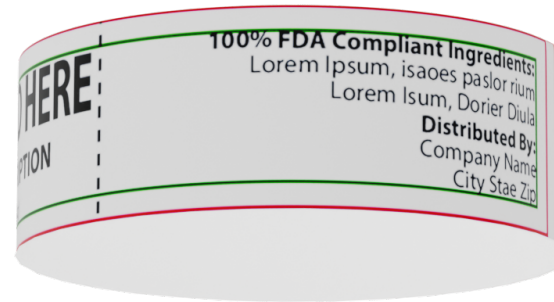
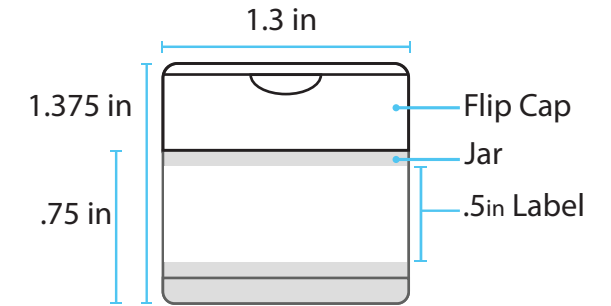
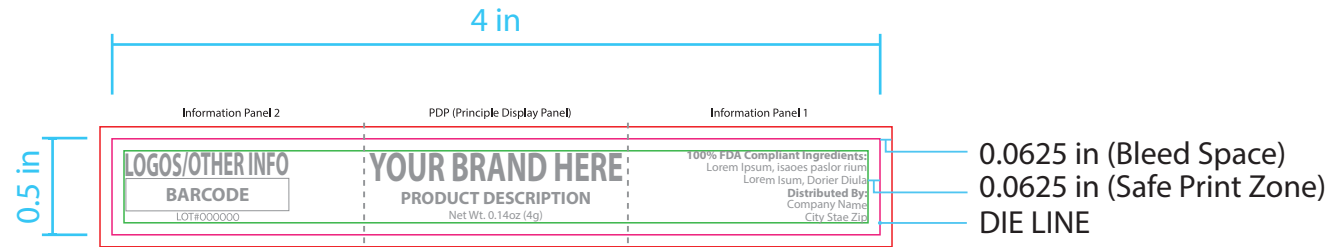

Rendered Label

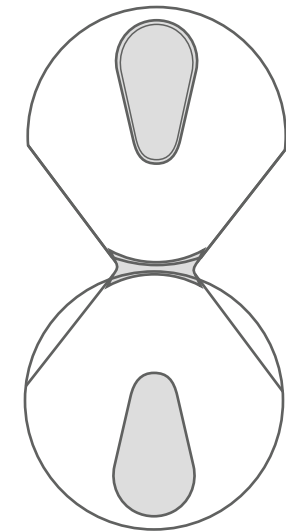

1.375in
Flip Cap

PREMIUM .5" x 4" STRAIGHT DIELINE (4g Jar)



BLEED 

DIELINE 

FOLD LINE 

SAFE ZONE 

SEAL AREA 

BLANK AREA 

#4

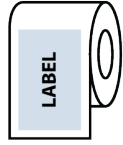

Left Side First

Left side of label will come off the roll first

LOGOS/OTHER INFO BARCODE LOT#000000	YOUR BRAND HERE PRODUCT DESCRIPTION Net Wt. 0.14oz (4g)	100% FDA Compliant Ingredients: Lorem Ipsum, Isocapsaicin Lorem Ipsum, Drier Diul Distributed By: Company Name City State Zip
---	---	--

STANDARD .5" x 3.125" STRAIGHT DIELINE (4g Jar)



- BLEED
- DIELINE
- FOLD LINE
- SAFE ZONE
- SEAL AREA
- BLANK AREA

#4

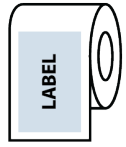

Left Side First

Left side of label will come off the roll first

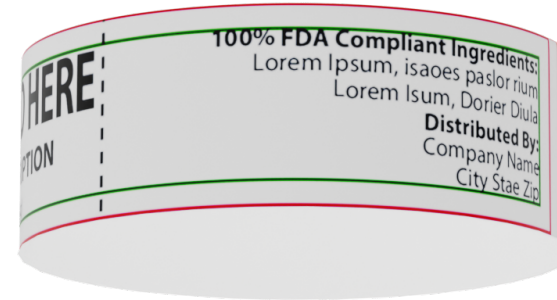
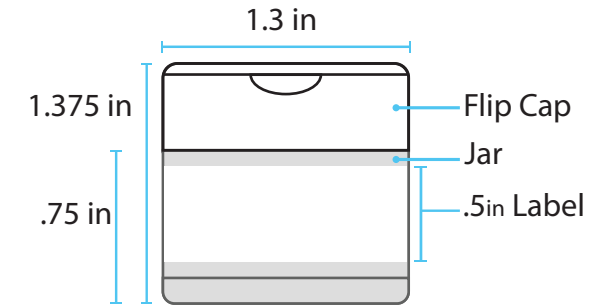
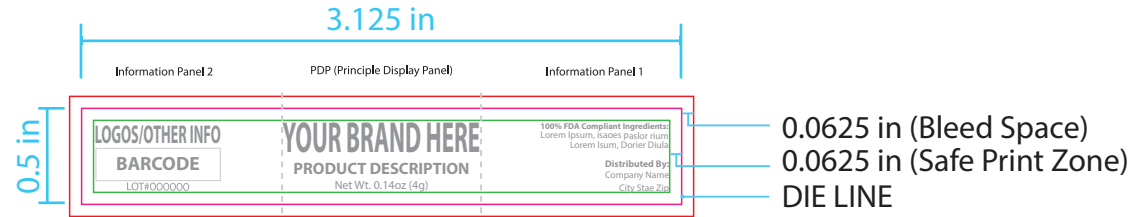

Rendered Label

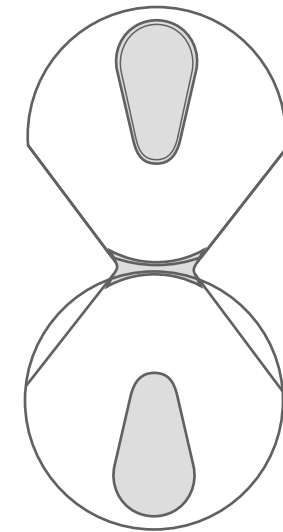

1.375in
Flip Cap

STANDARD 1" x 3" DIELINE (4g Mini Pump)

- BLEED
- DIELINE
- FOLD LINE
- SAFE ZONE
- SEAL AREA
- BLANK AREA

#4

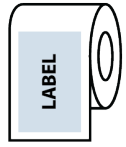

Left Side First

Left side of label will come off the roll first

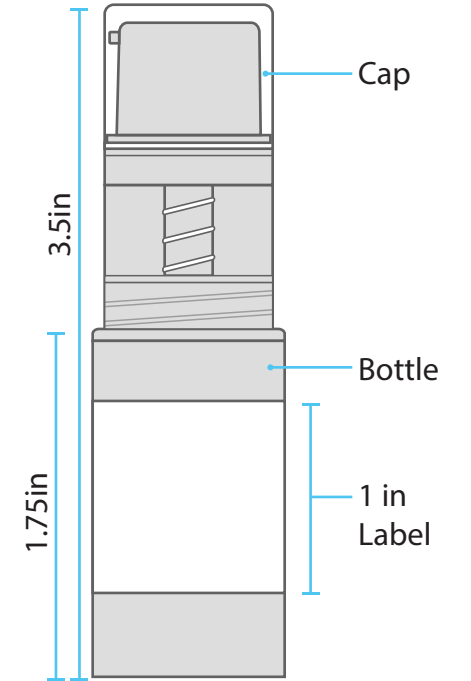
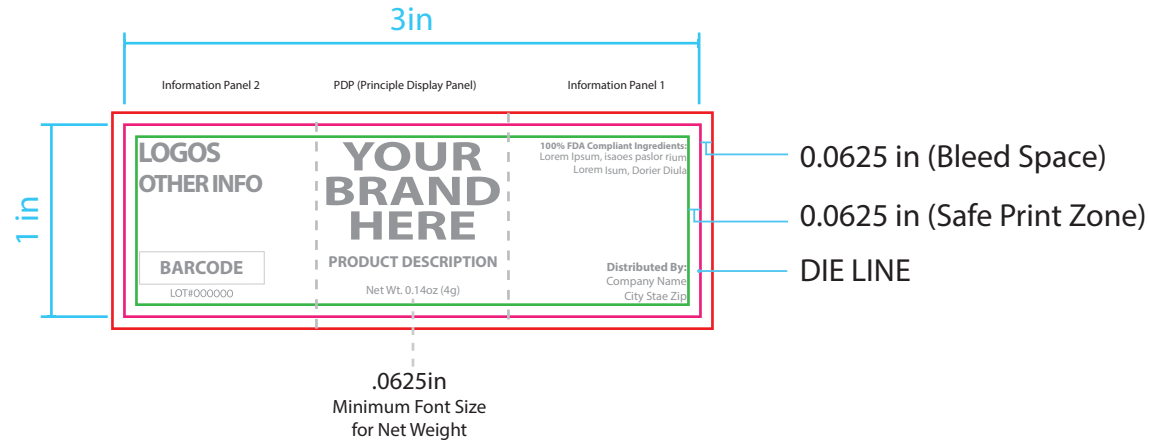

Rendered Label

STANDARD 1" x 3" DIELINE (4g Mini Pump)



BLEED 

DIELINE 

FOLD LINE 

SAFE ZONE 

SEAL AREA 

BLANK AREA 

#4

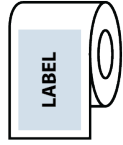

Left Side First

Left side of label will come off the roll first

LOGOS OTHER INFO	YOUR BRAND HERE	100% FDA Compliant Ingredients Lorem Ipsum, isaces paslor rium Lorem Ipsum, Dorier Dilita
BARCODE LOT#000000	PRODUCT DESCRIPTION Net Wt. 0.14oz (4g)	Distributed By: Company Name City Stae Zip

STANDARD 1.5" x 5" DIELINE (25g Jar)

- BLEED
- DIELINE
- FOLD LINE
- SAFE ZONE
- SEAL AREA
- BLANK AREA

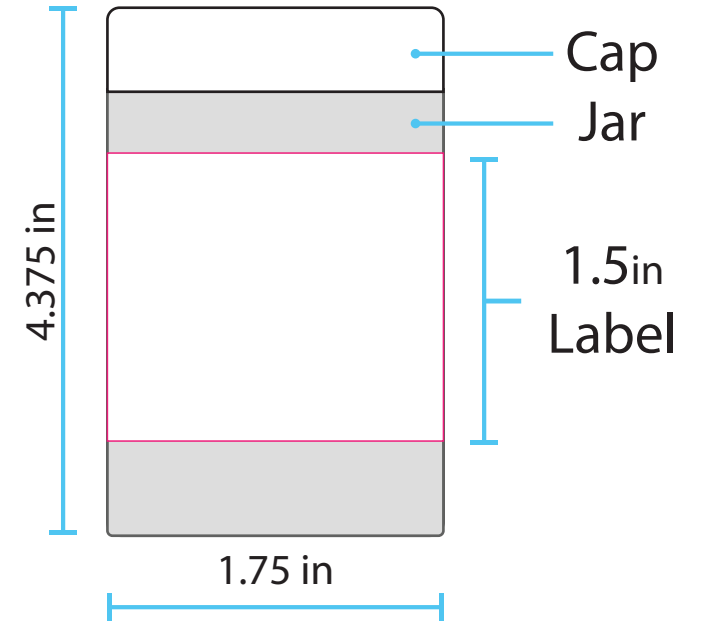
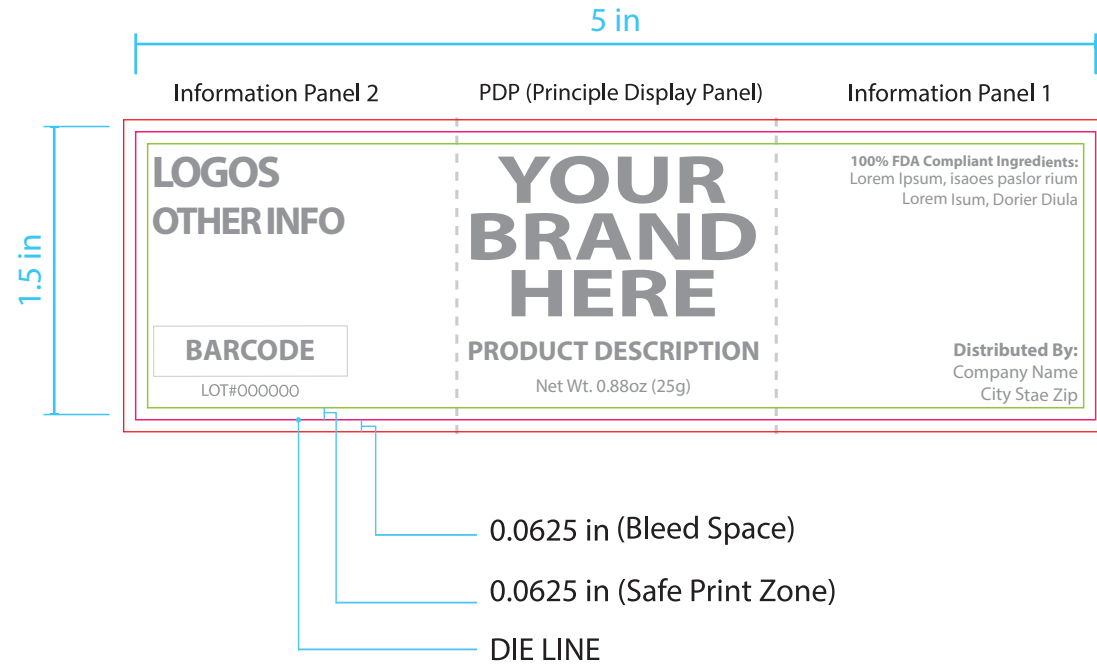
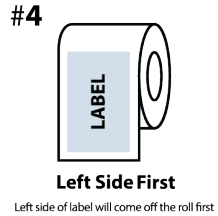

Rendered Label

STANDARD 1.5" x 5" DIELINE (25g Jar)



BLEED 

DIELINE 

FOLD LINE 

SAFE ZONE 

SEAL AREA 

BLANK AREA 

#4

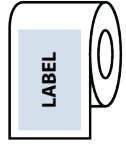

Left Side First

Left side of label will come off the roll first

<p>LOGOS OTHER INFO</p> <p>BARCODE LOT#000000</p>	<p>YOUR BRAND HERE</p> <p>PRODUCT DESCRIPTION Net Wt. 0.88oz (25g)</p>	<p>100% FDA Compliant Ingredients: Lorem Ipsum, isaoes paslor rium Lorem Isum, Dorier Diula</p> <p>Distributed By: Company Name City Stae Zip</p>
--	--	---

STANDARD 1.5" x 5" DIELINE (25g Pump)

- BLEED
- DIELINE
- FOLD LINE
- SAFE ZONE
- SEAL AREA
- BLANK AREA

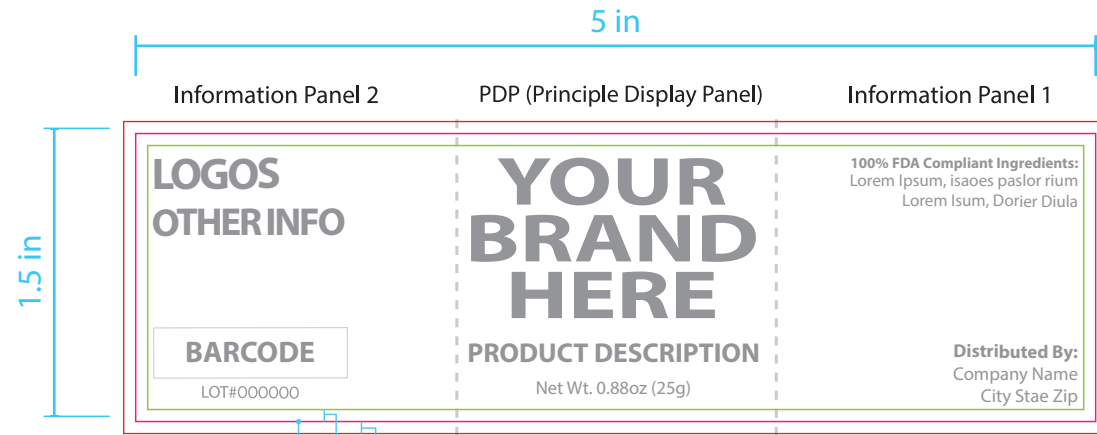
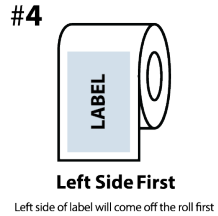

0.0625 in (Bleed Space)
 0.0625 in (Safe Print Zone)
 DIE LINE



Rendered Label

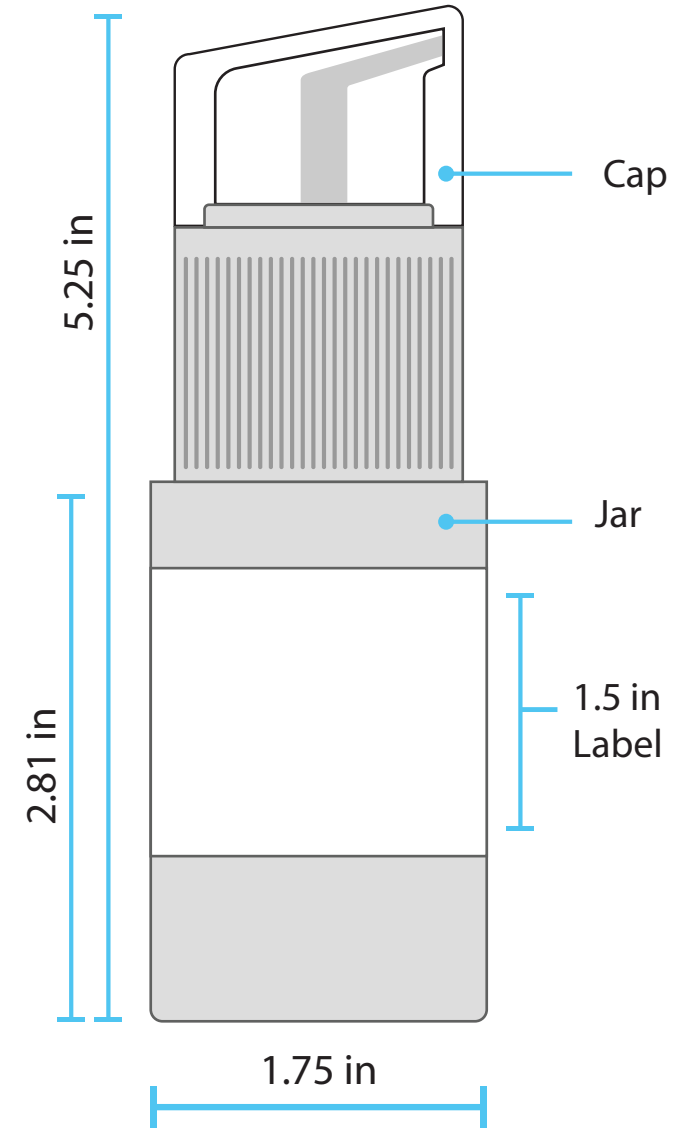

STANDARD 1.5" x 5" DIELINE (25g Pump)



#4

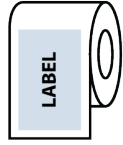

Left Side First

Left side of label will come off the roll first

<p>LOGOS OTHER INFO</p>	<p>YOUR BRAND HERE</p>	<p>100% FDA Compliant Ingredients: Lorem Ipsum, isaoes paslor rium Lorem Isum, Dorier Diula</p>
<p>BARCODE</p> <p>LOT#000000</p>	<p>PRODUCT DESCRIPTION</p> <p>Net Wt. 0.88oz (25g)</p>	<p>Distributed By: Company Name City Stae Zip</p>

STANDARD 1.5" x 5" DIELINE (45g Shaker)

- BLEED —
- DIELINE —
- FOLD LINE - - -
- SAFE ZONE —
- SEAL AREA
- BLANK AREA

#4

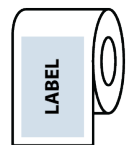

Left Side First

Left side of label will come off the roll first

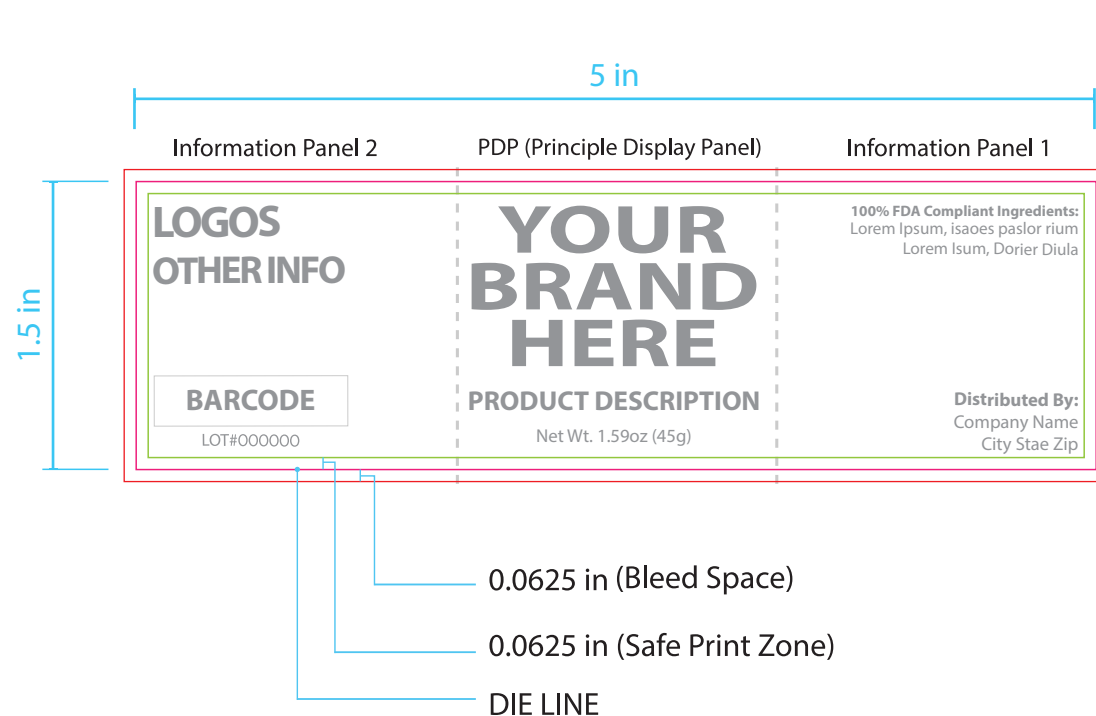

Rendered Label

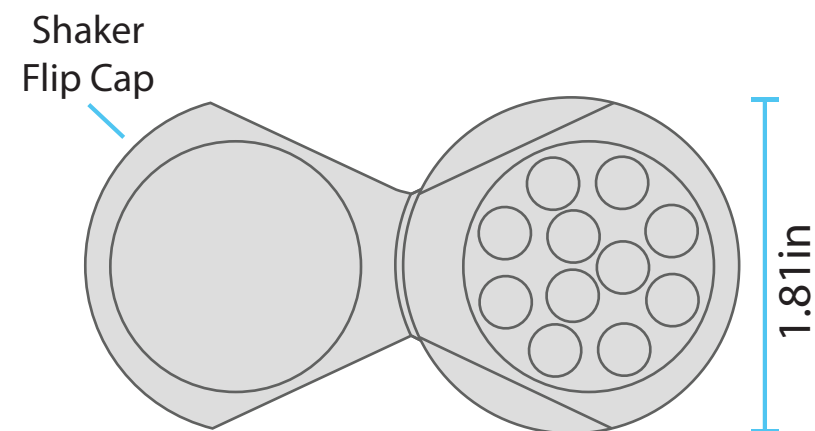
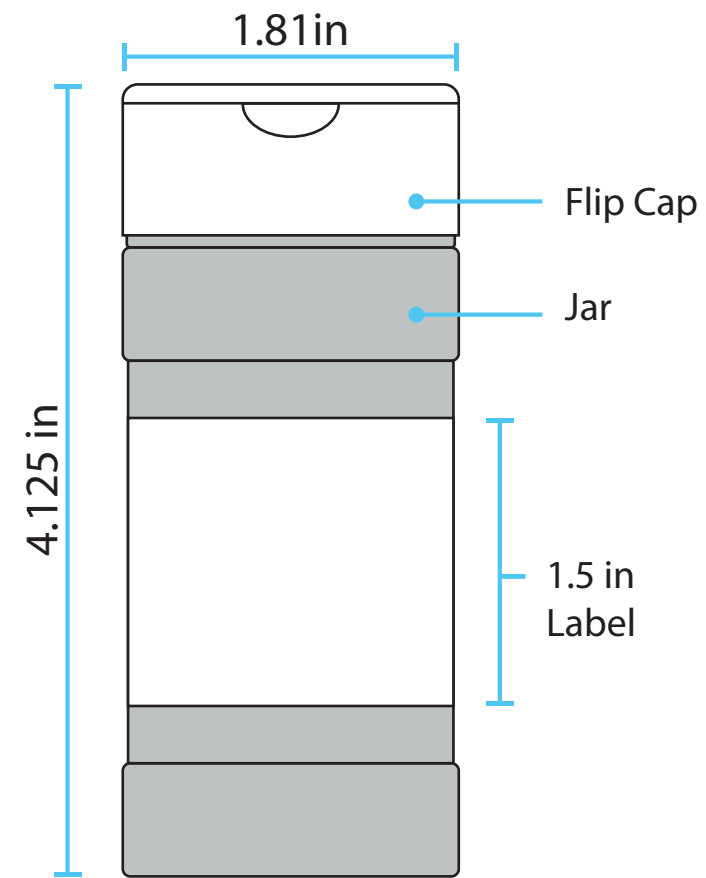

STANDARD 1.5" x 5" DIELINE (45g Shaker)



- BLEED 
- DIELINE 
- FOLD LINE 
- SAFE ZONE 
- SEAL AREA 
- BLANK AREA 

#4

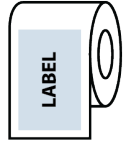

Left Side First

Left side of label will come off the roll first

<p>LOGOS OTHER INFO</p> <p>BARCODE LOT#000000</p>	<p>YOUR BRAND HERE</p> <p>PRODUCT DESCRIPTION Net Wt. 1.59oz (45g)</p>	<p>100% FDA Compliant Ingredients: Lorem Ipsum, isaoes paslor rium Lorem Isum, Dorier Diula</p> <p>Distributed By: Company Name City Stae Zip</p>
--	--	---

STANDARD 1.5" x 5" DIELINE (50g Jar)



- BLEED —
- DIELINE —
- FOLD LINE - - -
- SAFE ZONE —
- SEAL AREA
- BLANK AREA

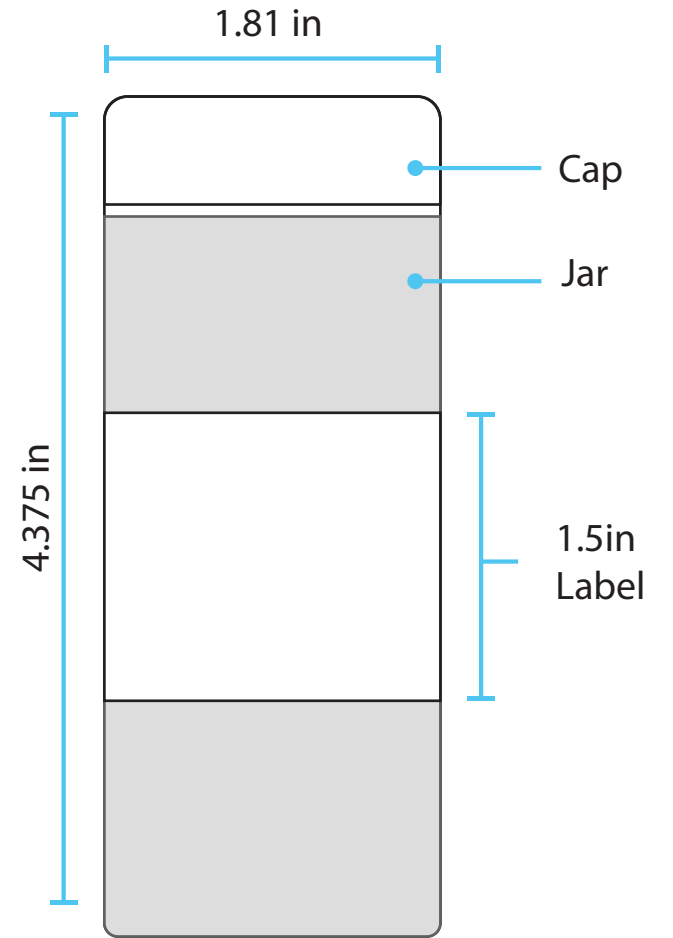
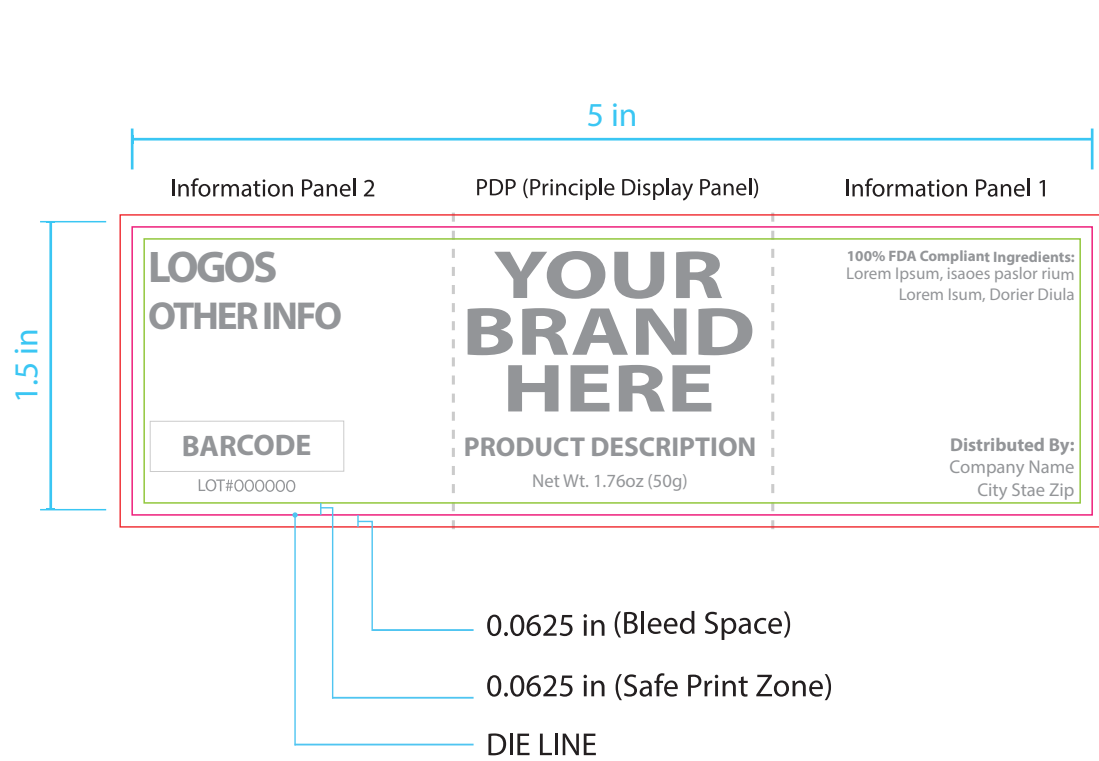
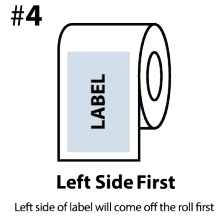

Rendered Label

STANDARD 1.5" x 5" DIELINE (50g Jar)



#4

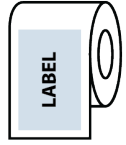

Left Side First

Left side of label will come off the roll first



STANDARD 3" x 2" LABEL DIELINE (1lb Container)

- BLEED
- DIELINE
- FOLD LINE
- SAFE ZONE
- SEAL AREA
- BLANK AREA

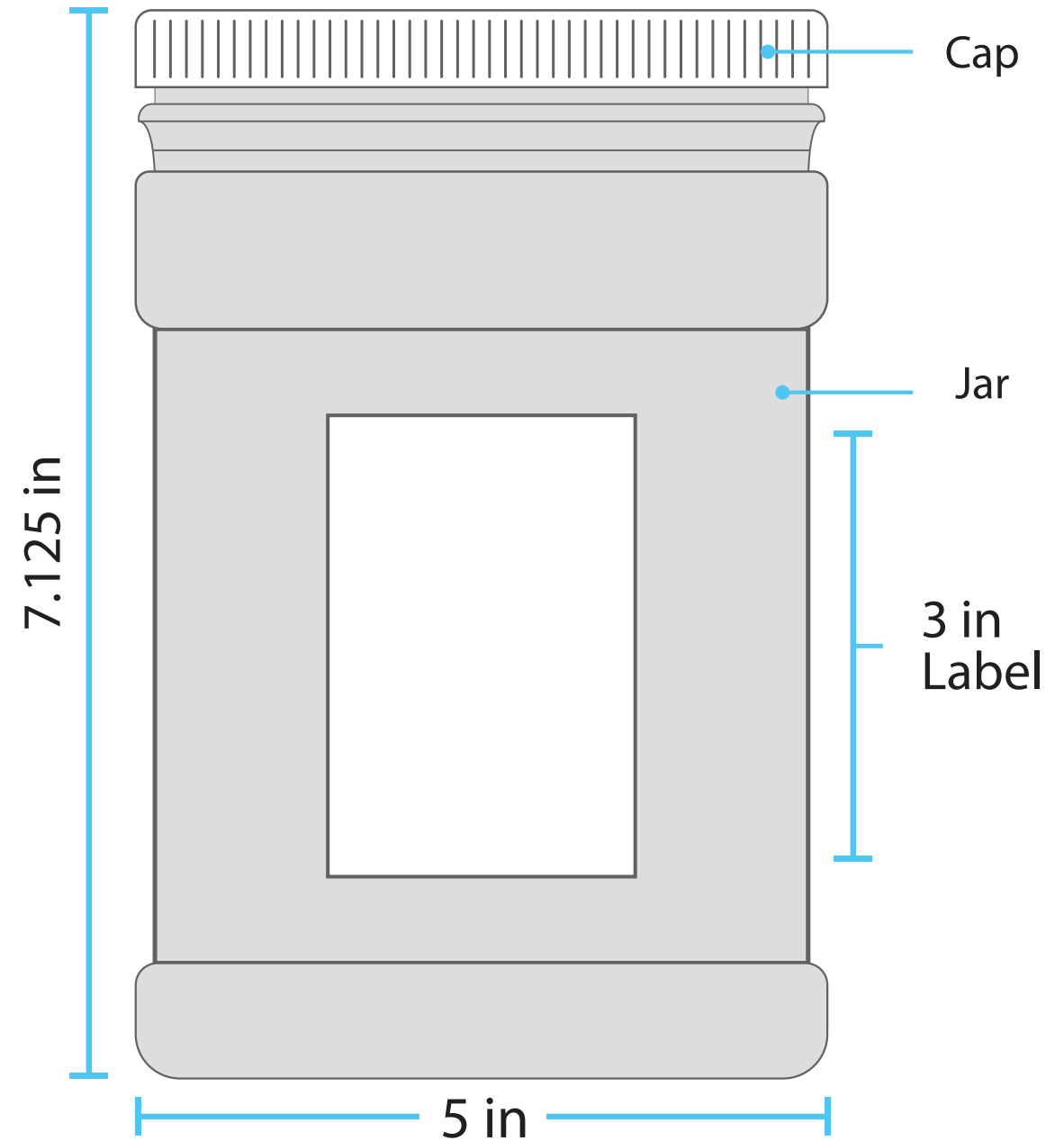
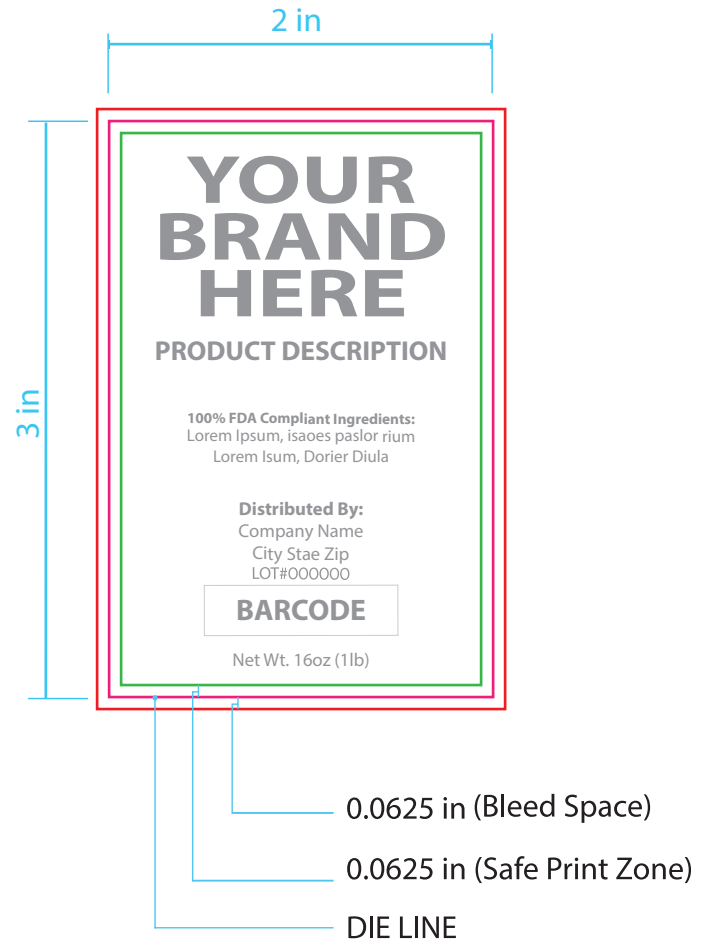
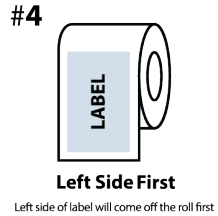

STANDARD 3" x 2" LABEL DIELINE (1lb Container)



#4

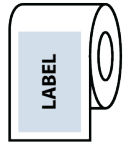

Left Side First

Left side of label will come off the roll first



STANDARD 3" x 2" LABEL DIELINE (1kg Container)

- BLEED
- DIELINE
- FOLD LINE
- SAFE ZONE
- SEAL AREA
- BLANK AREA

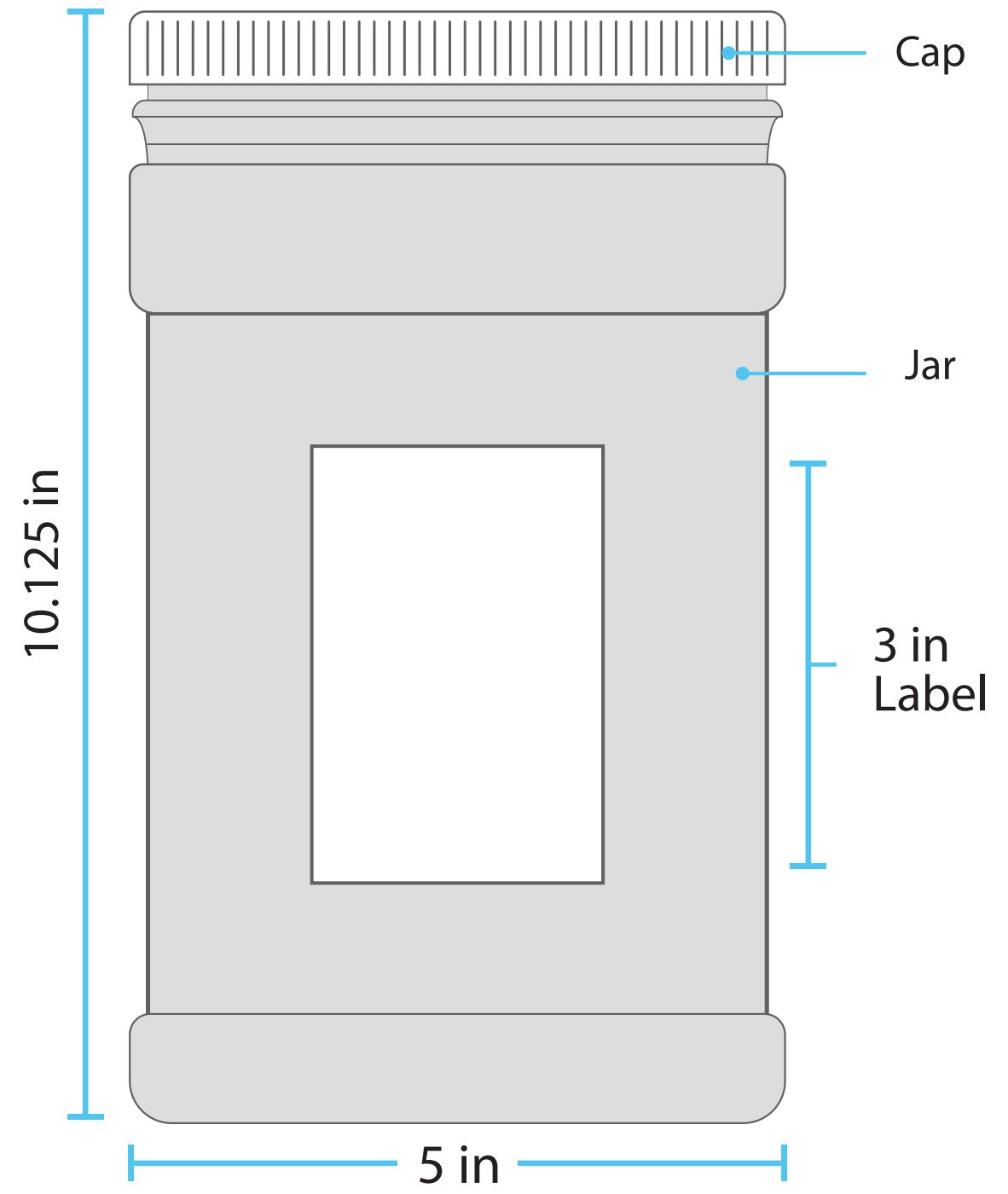
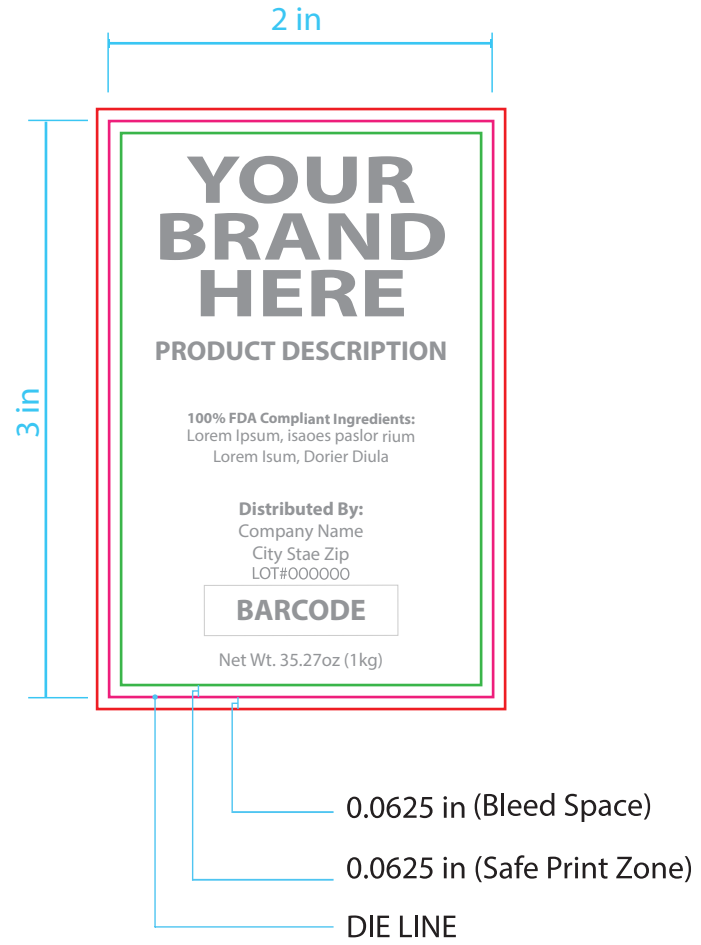
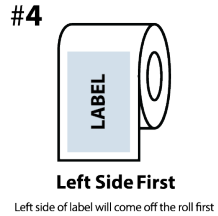

STANDARD 3" x 2" LABEL DIELINE (1kg Container)



BLEED ———

DIELINE ———

FOLD LINE - - -

SAFE ZONE ———

SEAL AREA 

BLANK AREA 

#4

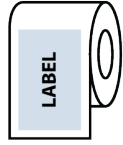

Left Side First

Left side of label will come off the roll first

**YOUR
BRAND
HERE**

PRODUCT DESCRIPTION

100% FDA Compliant Ingredients:
Lorem Ipsum, isaoes paslor rium
Lorem Isum, Dorier Diula

Distributed By:
Company Name
City Stae Zip
LOT#000000

BARCODE

Net Wt. 35.27oz (1kg)

STANDARD 4" x 4" LABEL DIELINE (4oz Container)

- BLEED 
- DIELINE 
- FOLD LINE 
- SAFE ZONE 
- SEAL AREA 
- BLANK AREA 

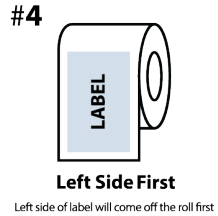

FRONT



BACK

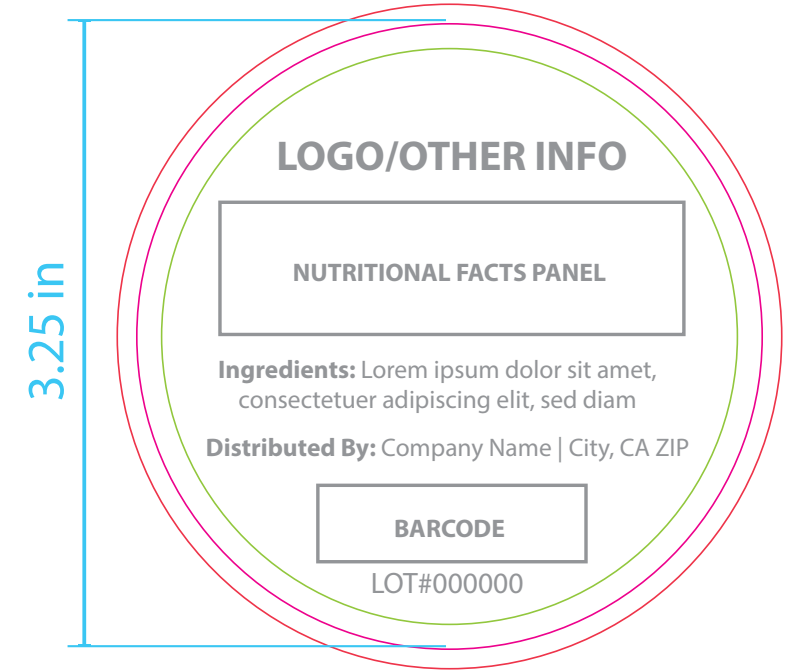

STANDARD 4" x 4" LABEL DIELINE (4oz Container)



#4

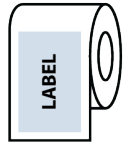

Left Side First

Left side of label will come off the roll first

FRONT



BACK

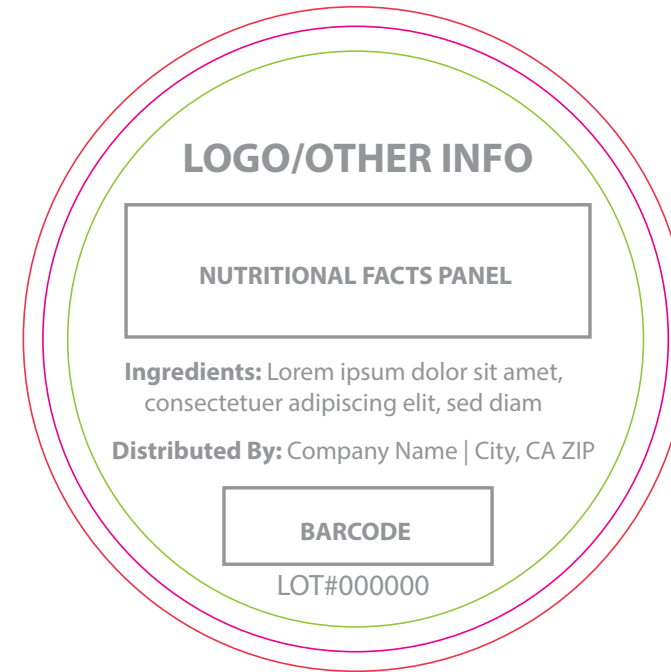

STANDARD SACHET DIELINE (70mm x 123mm)

- BLEED —
- DIELINE —
- FOLD LINE - - -
- SAFE ZONE —
- SEAL AREA
- BLANK AREA

#2

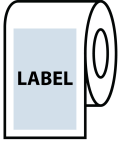

Bottom First
Bottom of label will come off the roll first

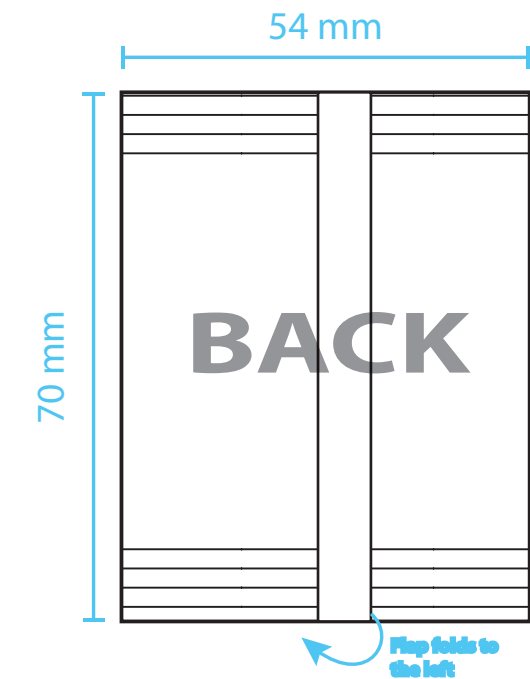
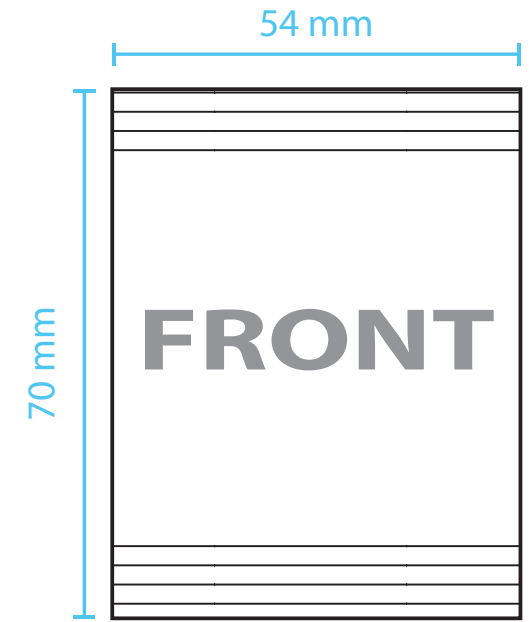
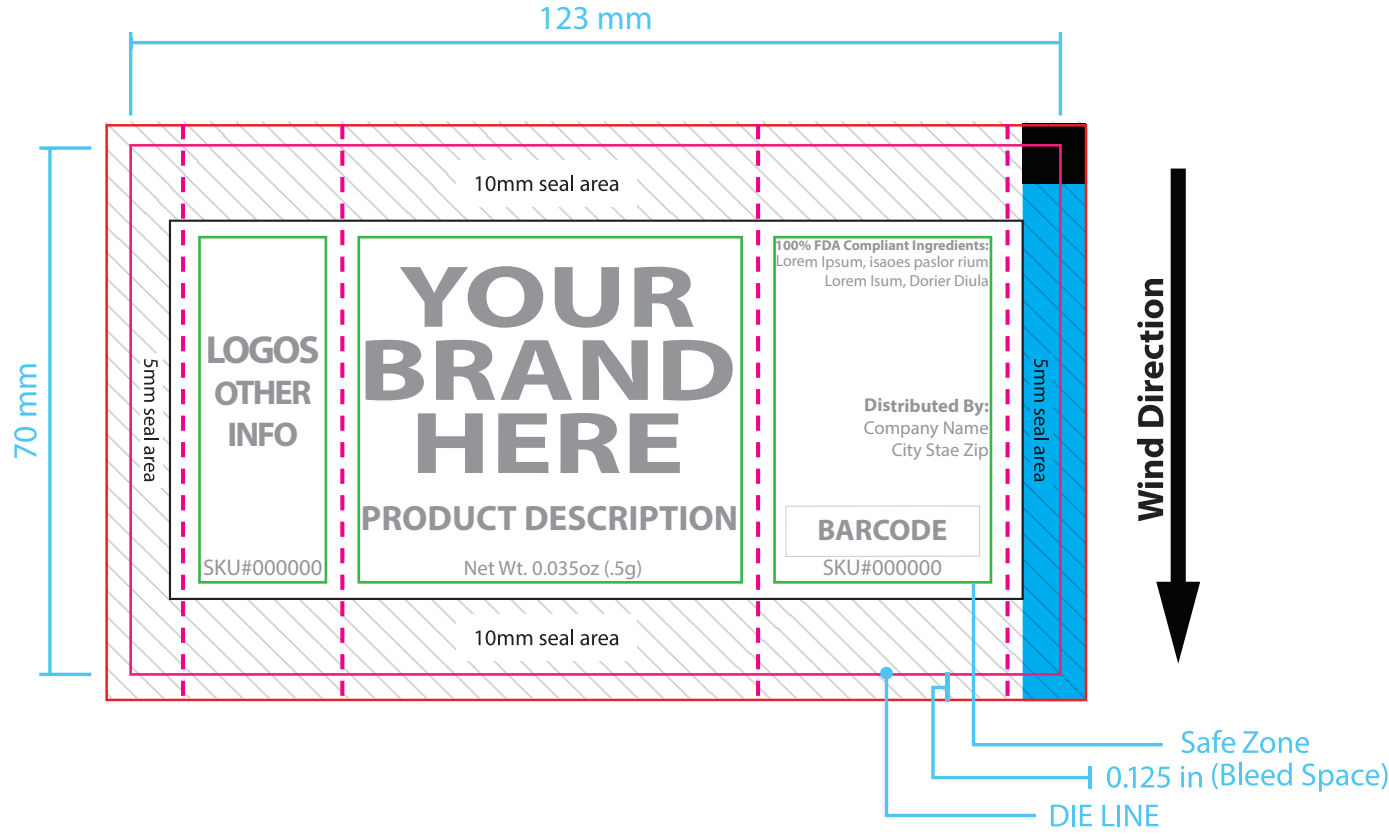

STANDARD SACHET DIELINE (70mm x 123mm)

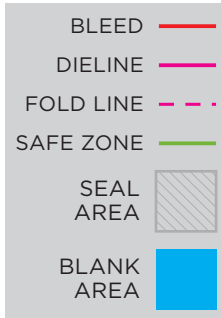

#2

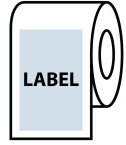

Bottom First

Bottom of label will come off the roll first



STANDARD STICK PACK DIELINE (60mm x 120mm)

- BLEED —
- DIELINE —
- FOLD LINE - - -
- SAFE ZONE —
- SEAL AREA
- BLANK AREA

#3

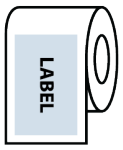

Right Side First
Right side of label will come off the roll first

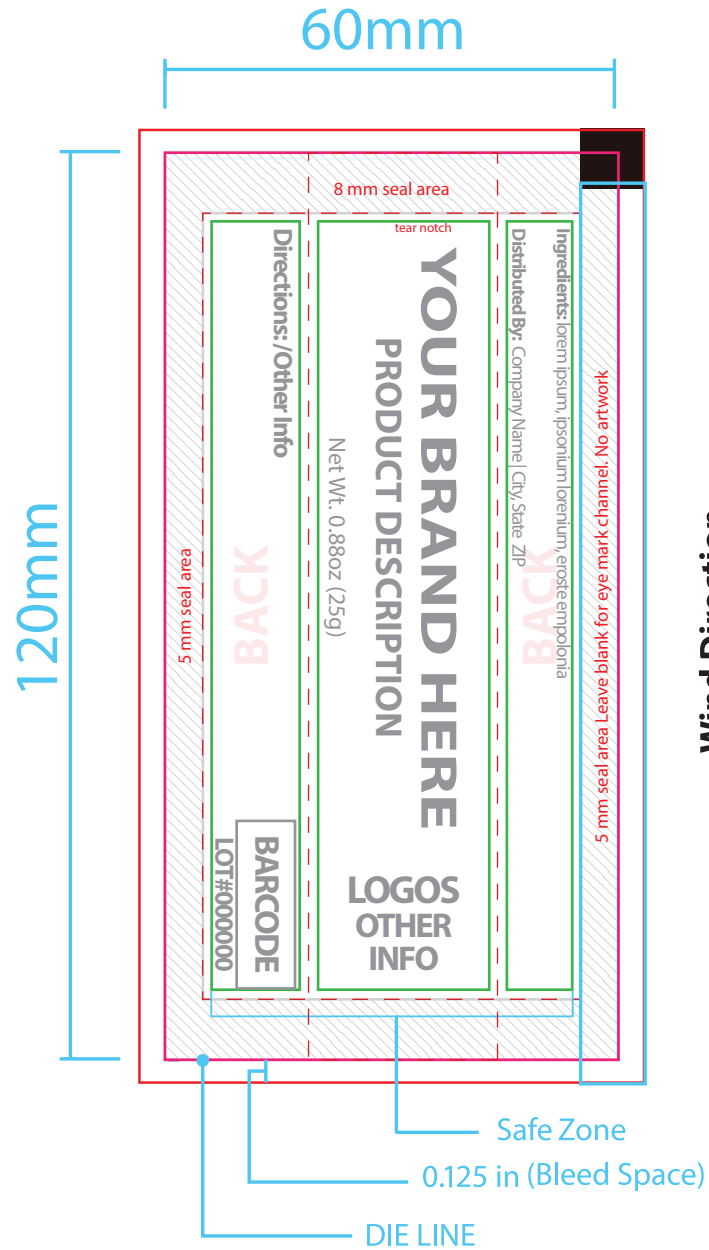

Wind Direction

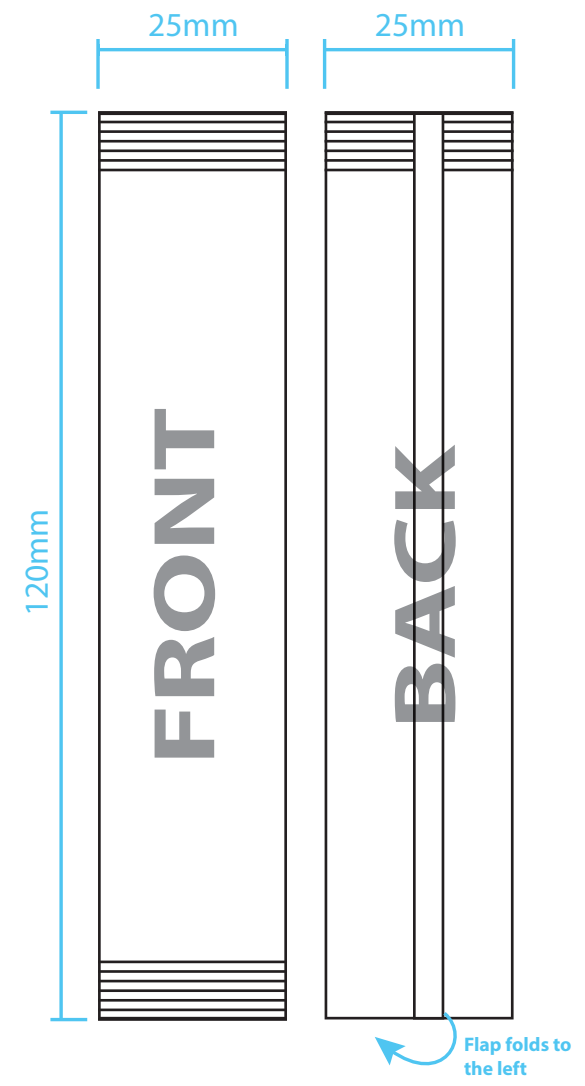
STANDARD STICK PACK DIELINE (60mm x 120mm)

- BLEED 
- DIELINE 
- FOLD LINE 
- SAFE ZONE 
- SEAL AREA 
- BLANK AREA 

#3

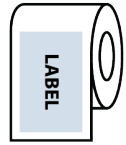

Right Side First

Right side of label will come off the roll first



STANDARD STICK PACK POUCH DIELINE (6.75in x 4in)



- BLEED
- DIELINE
- FOLD LINE
- SAFE ZONE
- SEAL AREA
- BLANK AREA

#2

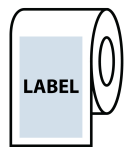

Bottom First

Bottom of label will come off the roll first

13.5in

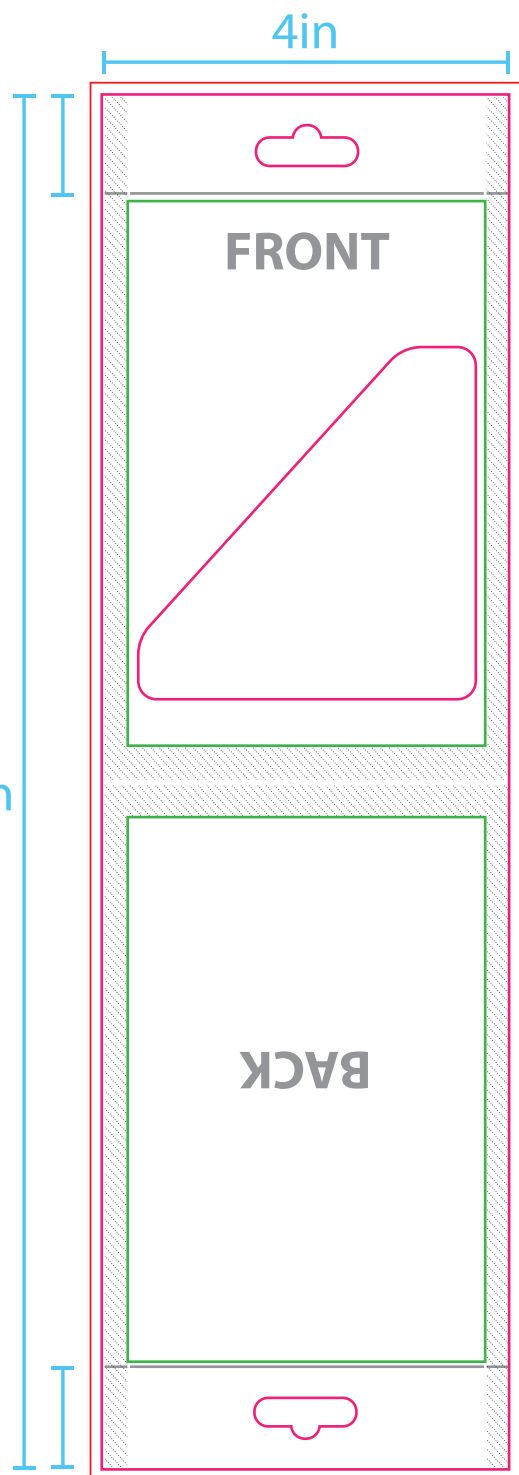

FRONT 4in



BACK 4in

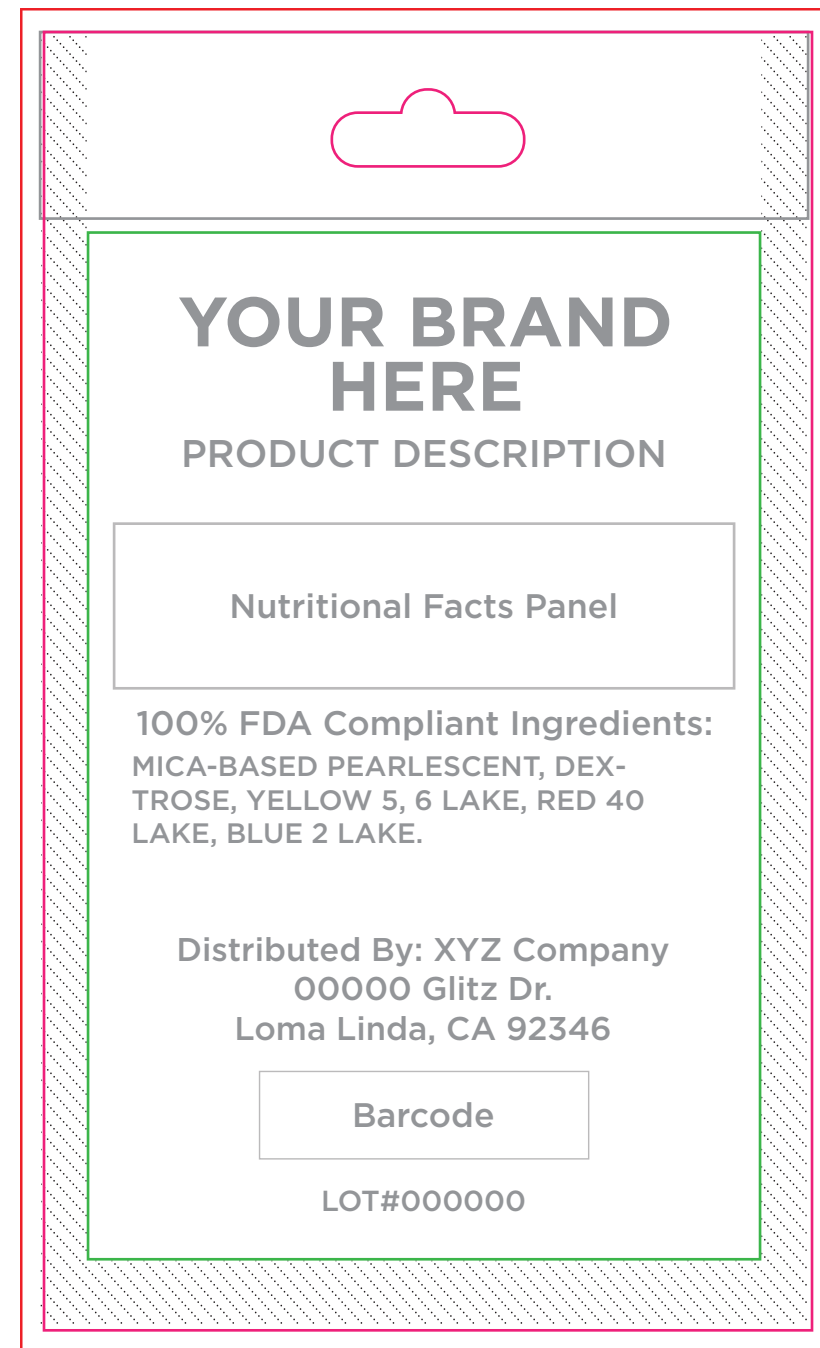

STANDARD STICK PACK POUCH DIELINE (6.75in x 4in)



#2

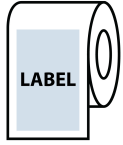

Bottom First

Bottom of label will come off the roll first

FRONT

BACK

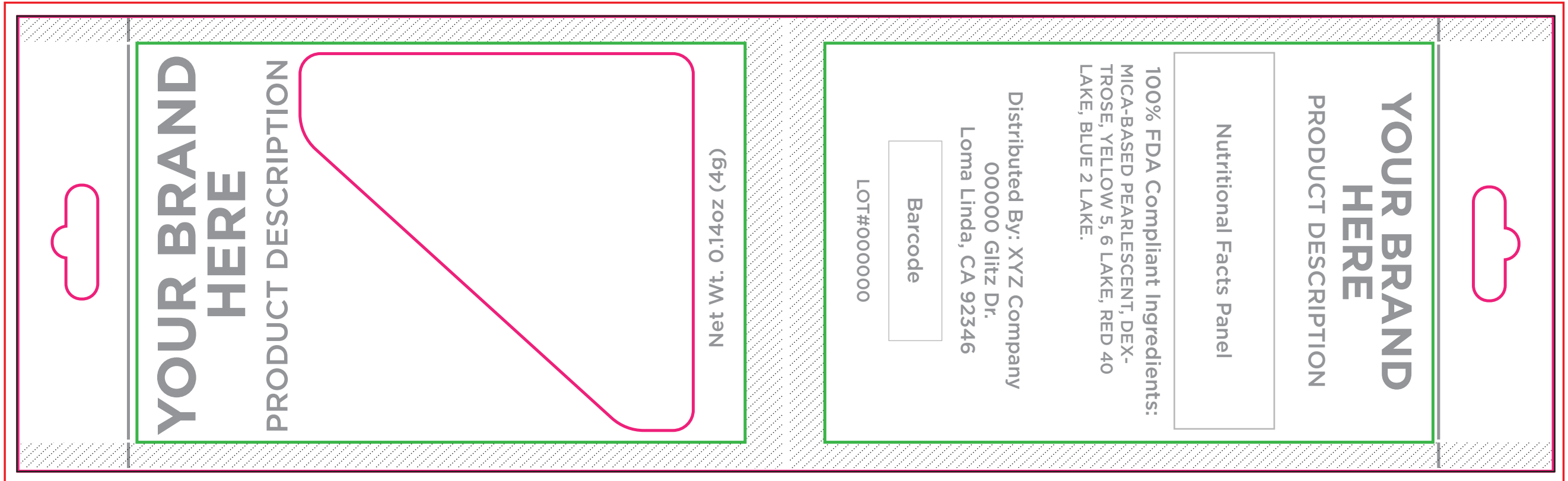

**YOUR BRAND
HERE**

PRODUCT DESCRIPTION

Net Wt. 0.14oz (4g)

**YOUR BRAND
HERE**

PRODUCT DESCRIPTION

Nutritional Facts Panel

100% FDA Compliant Ingredients:
MICA-BASED PEARLESCENT, DEX-
TROSE, YELLOW 5, 6 LAKE, RED 40
LAKE, BLUE 2 LAKE.

Distributed By: XYZ Company
00000 Glitz Dr.
Loma Linda, CA 92346

Barcode

LOT#000000

STANDARD 4" x 6" -4G BLISTER PACK BACKER DIELINE



BLEED ———

DIELINE ———

FOLD LINE - - - -

SAFE ZONE ———

SEAL AREA [diagonal lines]

BLANK AREA [blue square]

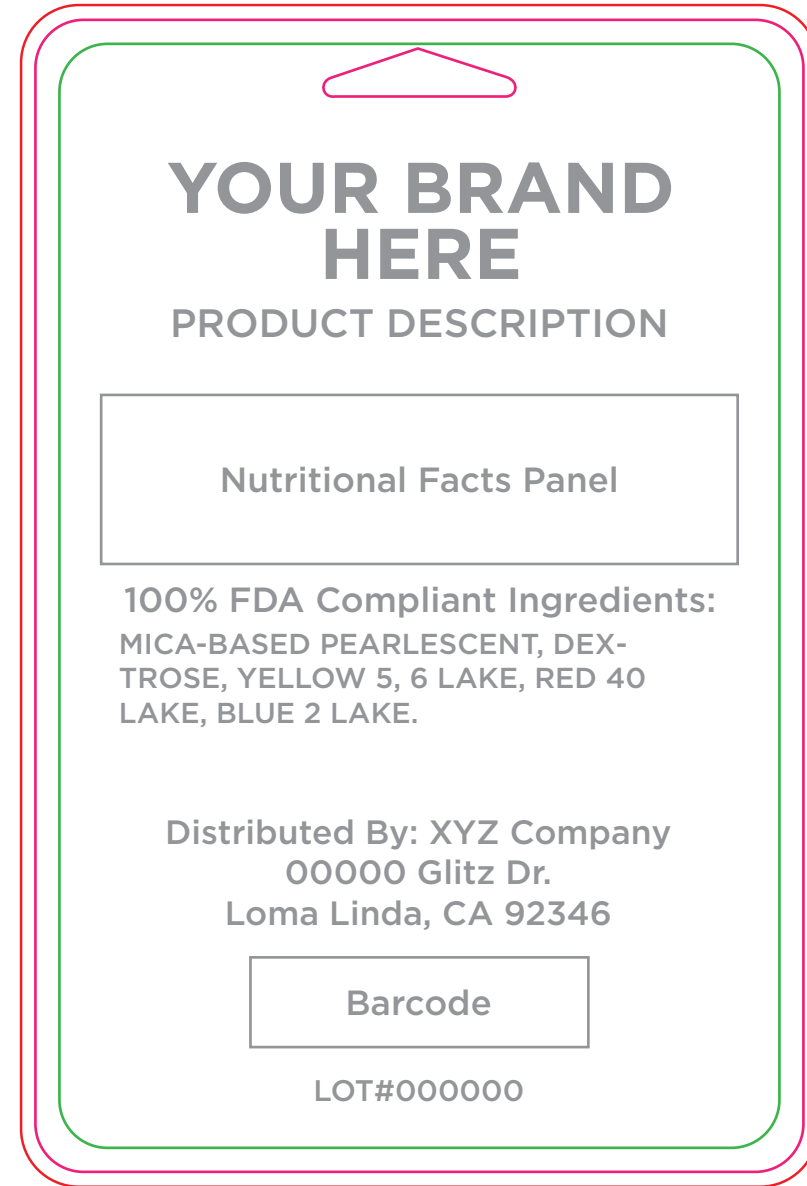
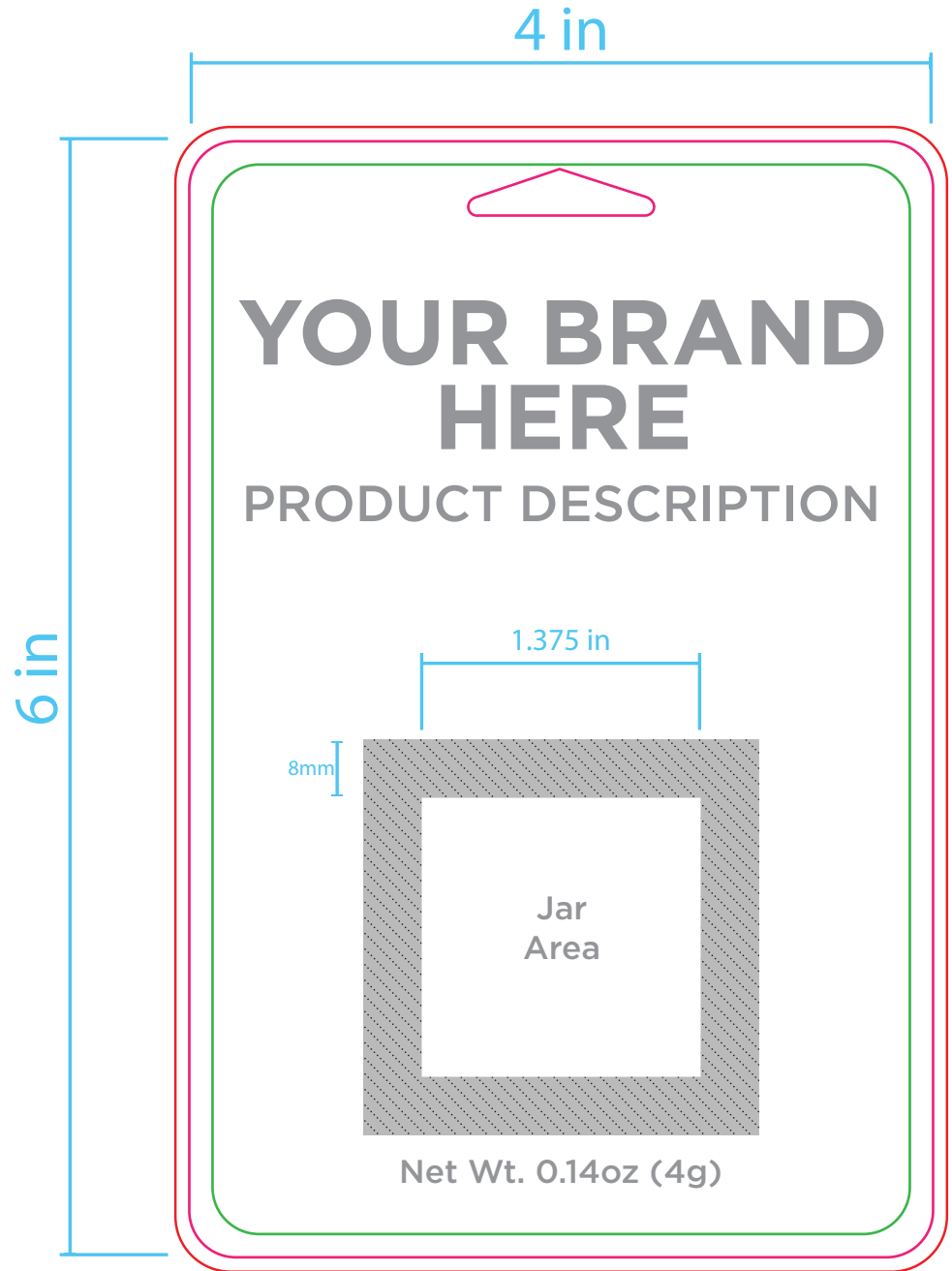

STANDARD 4" x 6" -4G BLISTER PACK BACKER DIELINE



BLEED ———

DIELINE ———

FOLD LINE - - - -

SAFE ZONE ———

SEAL AREA [diagonal lines]

BLANK AREA [blue square]

YOUR BRAND
HERE

PRODUCT DESCRIPTION

Jar
Area

Net Wt. 0.14oz (4g)

YOUR BRAND
HERE

PRODUCT DESCRIPTION

Nutritional Facts Panel

100% FDA Compliant Ingredients:
MICA-BASED PEARLESCENT, DEX-
TROSE, YELLOW 5, 6 LAKE, RED 40
LAKE, BLUE 2 LAKE.

Distributed By: XYZ Company
00000 Glitz Dr.
Loma Linda, CA 92346

Barcode

LOT#000000

STANDARD CLEAR SAMPLE SACHET WITH LABEL DIELINE (Bag: 7.25in x 2.5in | Label: .75in x 1.75in)



- BLEED —
- DIELINE —
- FOLD LINE - - -
- SAFE ZONE —
- SEAL AREA
- BLANK AREA

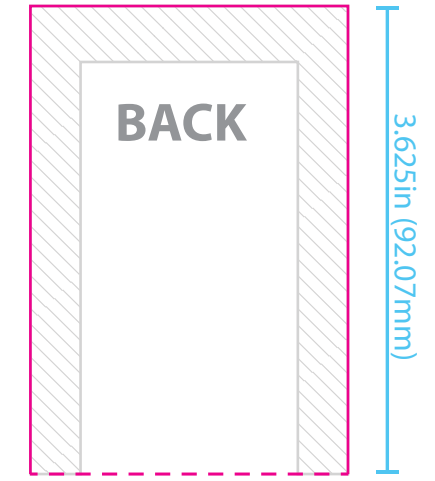
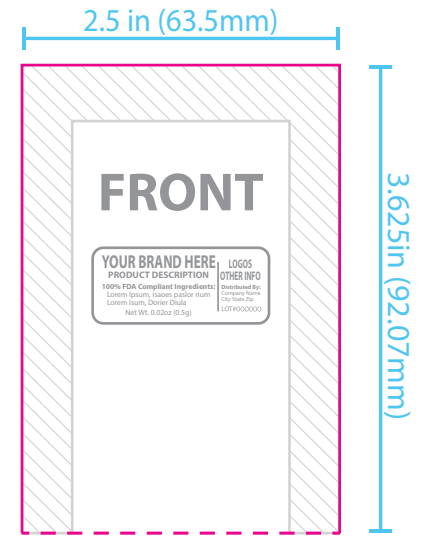
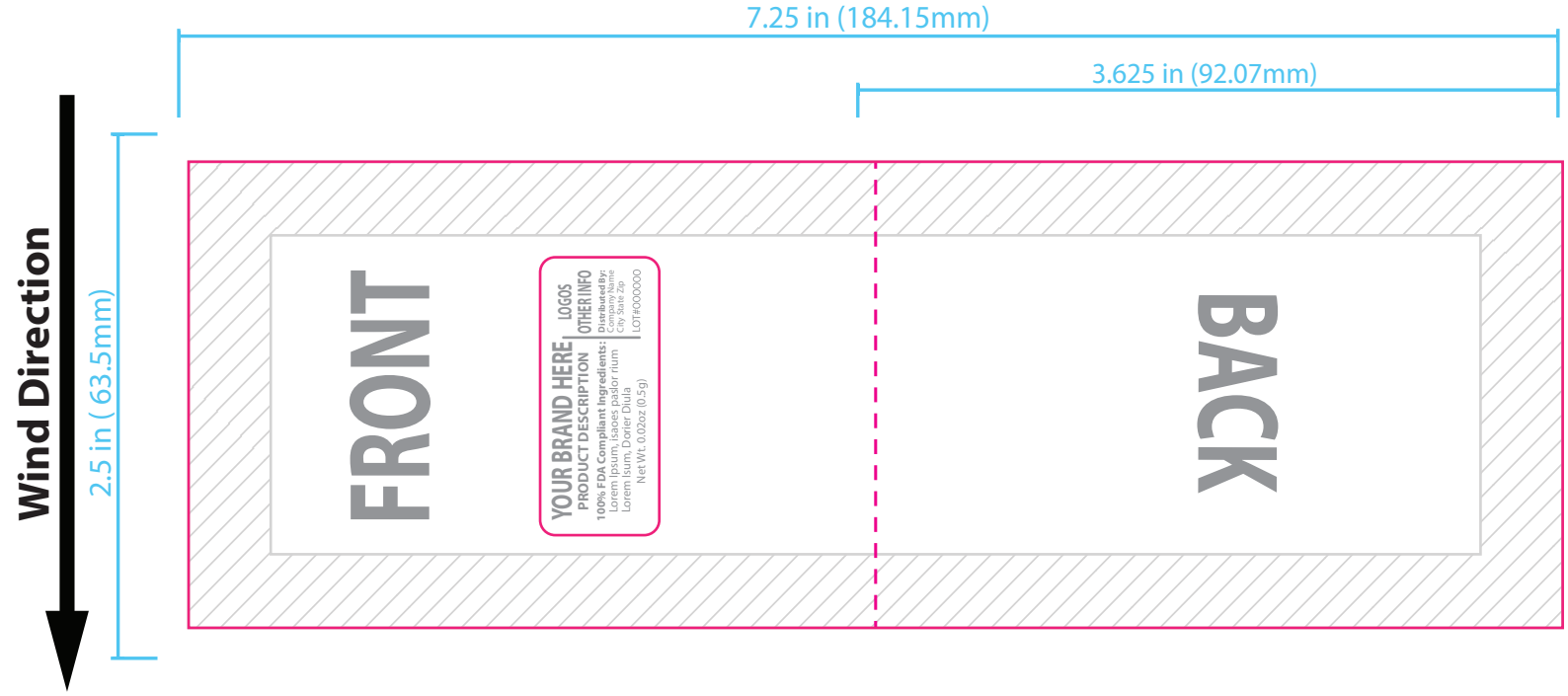
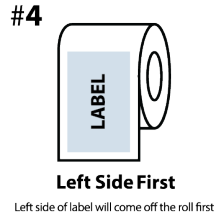

Folded/Sealed

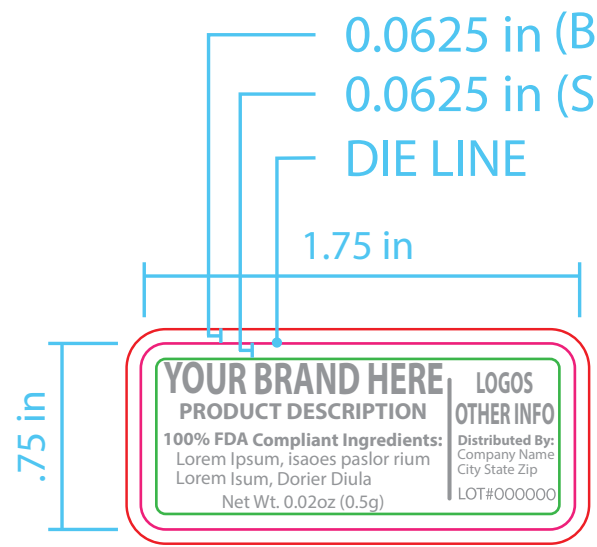

STANDARD CLEAR SAMPLE SACHET WITH LABEL DIELINE (Bag: 7.25in x 2.5in | Label: .75in x 1.75in)



#4

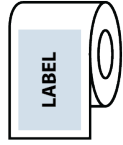

Left Side First

Left side of label will come off the roll first



FOUR COLOR EASY TEAR SACHET DIELINE (3in x4.5in) *Clear Sachet Option Available



- BLEED —
- DIELINE —
- FOLD LINE - - -
- SAFE ZONE —
- SEAL AREA
- BLANK AREA

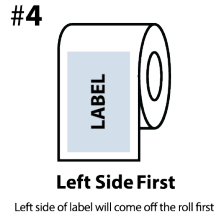

Wind Direction

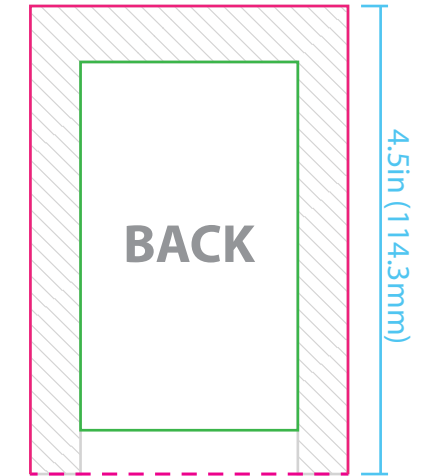
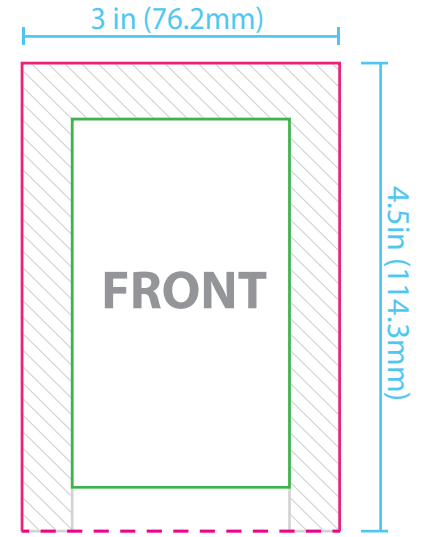
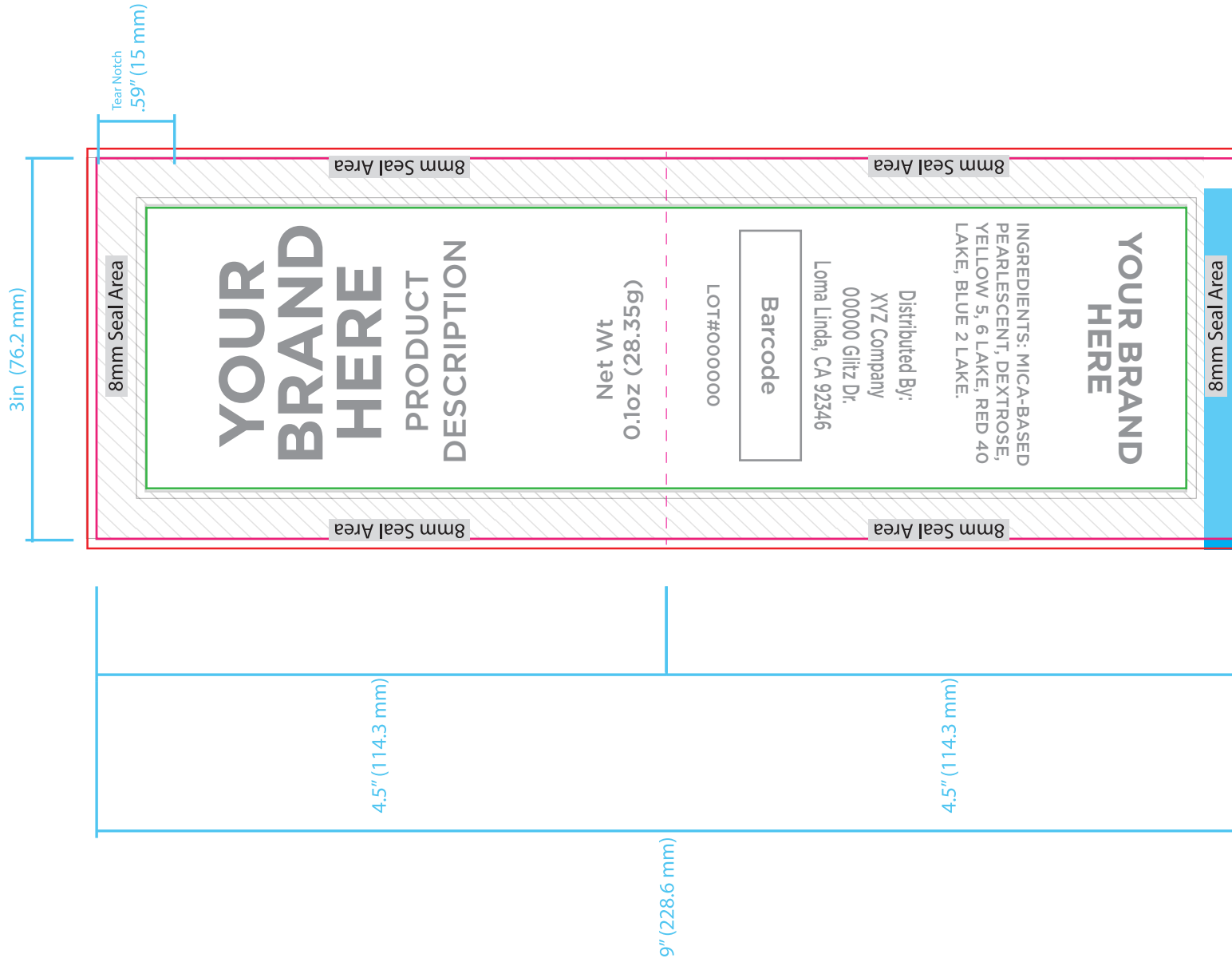

Folded/Sealed

FOUR COLOR EASY TEAR SACHET DIELINE (3in x4.5in) *Clear Sachet Option Available



BLEED ———

DIELINE ———

FOLD LINE - - - -

SAFE ZONE ———

SEAL AREA [Hatched Box]

BLANK AREA [Blue Box]

#4

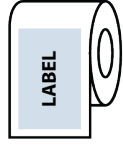

Left Side First

Left side of label will come off the roll first

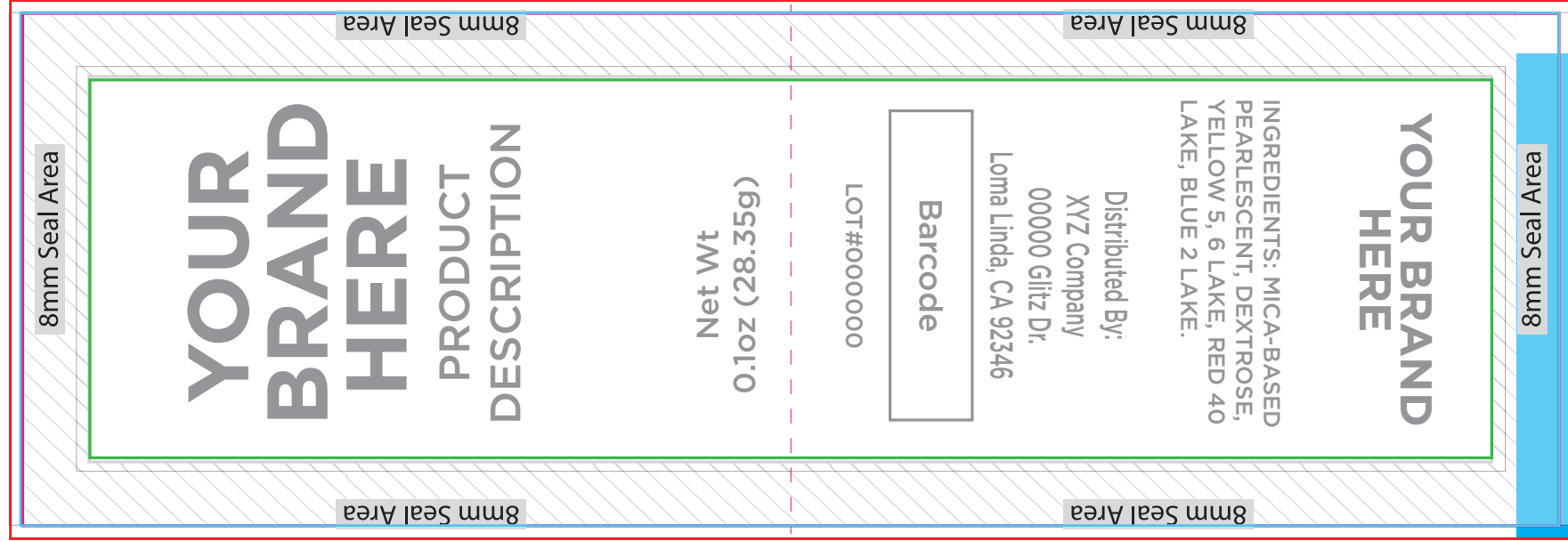

STANDARD NECKER DIELINE (Stock type: 12pt C2S) OUTSIDE



CUT	—————
CREASE	—————
PARTIAL CUT	—————
PERF	- - - - -
EDGE OF SHEET	- - - - -
ANNOTATION	—————
GLUE/TAPE	—————
OUTSIDE KO	—————
INSIDE KO	- - - - -
BLEED	—————
SAFETY/COPY	- - - - -
GLUE ASSISTS	—————
STRIPPING	—————
DIEBOARD	—————

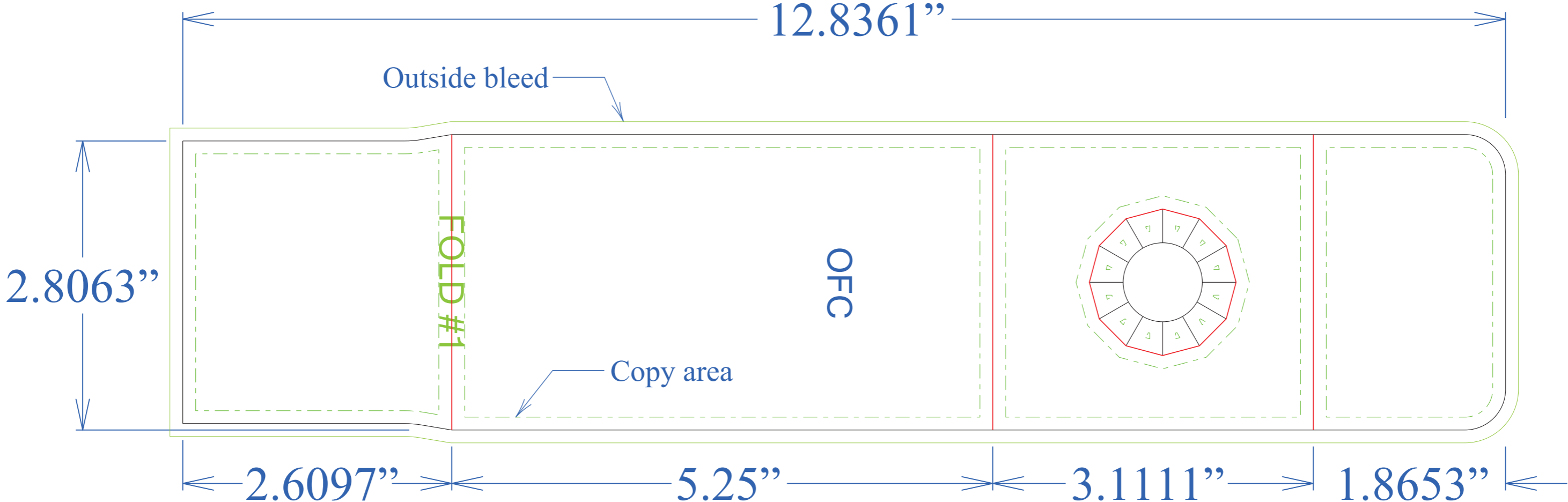

STANDARD NECKER DIELINE (Stock type: 12pt C2S) INSIDE



CUT	—————
CREASE	—————
PARTIAL CUT	—————
PERF	- - - - -
EDGE OF SHEET	- - - - -
ANNOTATION	—————
GLUE/TAPE	—————
OUTSIDE KO	—————
INSIDE KO	- - - - -
BLEED	—————
SAFETY/COPY	- - - - -
GLUE ASSISTS	—————
STRIPPING	—————
DIEBOARD	—————

