

JETCENTRAL

MINIATURE JET ENGINES FOR THE SERIOUS FLYER

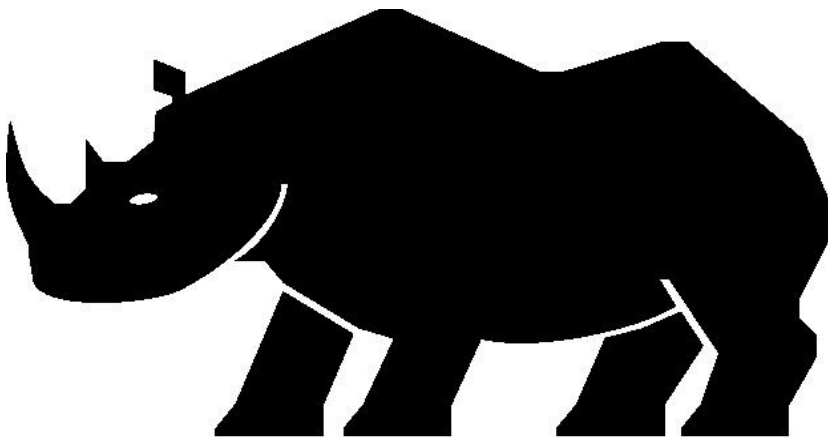
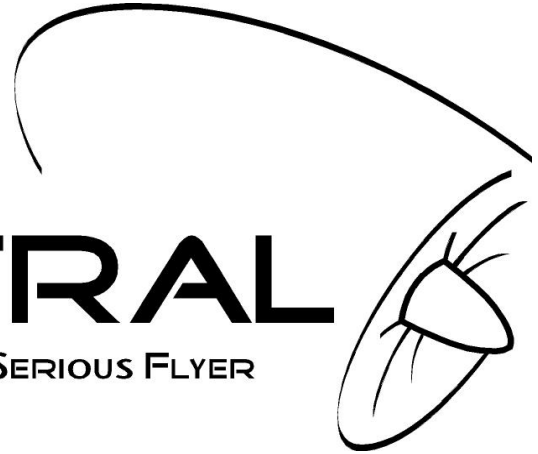

RHINO

SE series

OPERATION AND MAINTENANCE MANUAL

INTRODUCTION

JET CENTRAL produces the most advanced micro turbines available today: smaller, more powerful, faster acceleration, less fuel burn, lower temperatures, higher quality, less maintenance and the best price. **JET CENTRAL**, an ISO 9000 Company is a full production engine manufacturer, producing high quality parts to be assembled into the newest line of micro turbines.

We are committed to our turbines in a way never seen before. You won't find a more knowledgeable company in micro turbines than **JET CENTRAL**.

SPECIFICATIONS

- Thrust: 200 Newton (45lbs) @ 121.000 rpm Idle
- Thrust: 4.7 Newton (1lbs) @ 32.000
- RPM range: 32,000-121,000
- Weight: 1.9 Kg (4.19lbs)
- Diameter: 111.0 mm (4.37")
- Length: 306mm (12.047")
- Exhaust gas temperature: 500°-700°
- Fuel consumption: 0.7 Lt/min (24.64oz) @121 k

TABLE OF CONTENTS

INTRODUCTION.....	1
SPECIFICATIONS.....	1
1 Purchase Agreement, Full Assumption of Liability and Indemnity Agreement	4
2 Safety Information.....	6
2.1 Safety Rules.....	7
3 Turbine System Components Description	8
3.1 Parts List	8
3.2 Turbine.....	9
3.3 Fuel / Oil System	9
3.4 Kero Start System	9
3.5 Hand Data Terminal (HDT).....	10
3.6 SE POWERPACK / ECU.....	11
3.6.1 Overview.....	11
3.6.2 Features.....	11
3.6.3 Measurements.....	11
3.6.4 Other functions	12
3.6.5 Micro SD memory slot location	12
3.7 Optional Telemetry Interface	12
4 Turbine System.....	13
4.1 Connections to SE POWERPACK / ECU	14
4.2 System Batteries	15
4.3 Receiver battery.....	15
4.4 Radio Receiver	15
4.5 Fuel System Connections	16
4.6 Mounting Turbine and POWERPACK	16
5 Programming the SE POWERPACK / ECU	17
5.1 Welcome Screens.....	17
5.2 Main Screen.....	17
5.3 Menu Screen	18
5.4 Starting Parameters Sub-menu	18
5.5 Running Parameters Sub-menu	19
5.5.1 Air Speed Limit / Turboprop RPM Limit.....	20
5.6 Radio Adjustment Sub-menu.....	20
5.6.1 Transmitter Setup	20
5.6.2 Throttle Curves	21
5.6.3 Types of Throttle Curves	22
5.7 Info Menu.....	22
5.8 Battery Menu	23
5.9 Alarm Display.....	23
5.9.1 Stop Alarms	23
5.9.2 Info Alarms	24
5.9.3 Turbine Status Messages	24
5.9.4 Turbine Alarm Messages	25
5.10 World Menu.....	26
5.11 Memory Menu.....	26
5.11.1 Using the micro SD Card	26
5.12 Test Menu.....	27

6 Turbine Starting	27
6.1 Preparing the Turbine for Installation	27
6.2 Important notes	27
6.3 Priming	28
6.4 First engine runs	29
6.5 Starting procedure	29
6.6 Engine shut down procedure	30
6.7 What to do in case of an Emergency	30
7 Fuel, Oil and Fuel System Care	30
7.1 Recommend Fuel	30
7.2 Recommend Oil	30
7.3 Fuel Filter	31
7.4 Header Tank	31
7.5 Fuel Line	31
7.6 Tanks	31
8 Multiengine Installation	31
9 Maintenance	31
10 Troubleshooting	32
11 Optional Accessories	33
11.1 S-Bus Pitot speed sensor	33
11.2 S-Bus Turboprop RPM sensor	33
11.3 S-Bus Telemetry adaptor	33
12 Jet Central BB Software	33
12.1 Introduction	33
12.2 Using the application	34
12.3 Dynamic Graphics	35
13 Turbine Quick Start Guide	35
14 Safety Tips	36
15 Lifetime Turbine Warranty	37
16 Worldwide Network	38
Appendix A: Thrust Graph	39
Appendix B: Mounting Dimensions	39
Appendix C: Pipe Gaps	40

1 Purchase Agreement, Full Assumption of Liability and Indemnity Agreement

Buyer purchases from Jet Central, a Limited Liability Company or from one of Jet Central authorized dealers, a MINIATURE TURBOJET ENGINE for model aircraft, ("Model Engine") for the invoice price, accompanying this sale, and Buyer and Jet Central agree to all of the following terms and conditions:

1. Buyer's Representations. Buyer represents that he/she is very experienced in model airplane operation, and that all of the information set forth in the Purchase Application is true and correct. Jet Central relies on such representations, and would not enter into this sale but for these representations.

2. Buyer's Acknowledgment of Risks and Dangers. Buyer recognizes that operation of the Model Engine may be dangerous, and that under certain circumstances, its handling will be dangerous. As set forth in Paragraph 3 below, Buyer accepts full responsibility for all of these risks and waives all liability as against Jet Central

(a) Buyer's Acknowledgment of Danger. Buyer expressly acknowledges that use of the Model Engine is dangerous if improperly handled, and could inflict injury if attempts are made to handle it properly, if the user does not fully acquaint himself/herself with the Model Engine's operation procedures. The Model Engine may cause burns to the user, or the user's assistant, particularly in the start-up procedure, and Buyer agrees to use extreme caution. The Model Engine exhaust is extremely hot, and will burn someone or something placed directly behind the exhaust tube. Highly flammable liquid is used to operate the Model Engine and it or its fumes will ignite easily and flare up rapidly. The Model Engine itself remains extremely hot, after it is shut off, and requires a cooling down period. Improper use of the Model Engine or failure to follow Academy of Model Aeronautics ("AMA") guidelines and rules will result in injury to the user, the user's assistant, or bystanders. Operation of the Model Engine in any location other than an approved location, and under safe circumstances could lead to injury to bystanders. A risk exists from explosion, in the event of tampering, modifications leading to over-speed or extreme metal fatigue.

(b) Buyer's Obligation to Become Fully Acquainted With Operation Procedure. Buyer acknowledges receipt of operating instructions for the Model Engine which depicts its handling and operation. Buyer agrees to thoroughly acquaint himself/herself with these materials, and to require his/her assistant to become equally familiar with them. Buyer expressly agrees not to allow any person to assist in the start-up procedure of the Model Engine, who has not become thoroughly familiar with these materials.

(c) Agreement to Use Qualified Assistant in Start-Up Procedure. Buyer acknowledges that the start-up procedure for the Model Engine cannot be safely done, without an assistant. Buyer expressly agrees to use an assistant, who is thoroughly familiar with the Model Engine and its operation as set forth above, on each occasion when the Model Engine is started up.

(d) Warning to Bystanders. Buyer acknowledges that injury or burns to bystanders could occur, during the start-up procedure or when operating the Model Engine. Buyer expressly agrees to take all steps necessary to assure that no bystander will be in position to receive injuries during the start-up procedure, or while the Model Engine is running.

3. Full Assumption of Liability; Waiver and Release of Jet Central. Buyer assumes all risk of injury, harm and damage, of every nature whatsoever, to himself/herself and his/her property. Buyer fully and completely waives and releases any and all claims which he/she might have at any time arising out of the purchase, handling, or operation of the Model Engine. This assumption, waiver and release is complete, full, and comprehensive.

(a) Release Even If Jet Central Is Negligent. The waiver and release contained herein releases Jet Central from all conduct, no matter how it could be characterized or alleged. Jet Central shall not be liable for its own negligence, whether active, passive, primary, or secondary. Jet Central shall not be liable for its sole negligence. Jet Central shall not be liable for its willful misconduct. Jet Central shall not be liable

based on any theory in strict liability in tort. Jet Central shall not be liable for any alleged breach of warranty, whether express or implied, of any nature whatsoever, whether a warranty of fitness for a particular use, merchantability, or otherwise.

(b) Waiver Effective for All Time. The waiver and release contained herein is effective, without regard to the passage of time. It is effective indefinitely. It will not be changed by any modification to the Model Engine, to any later sale, or other changes in circumstances.

(c) Release Extends to Jet Central and all its Associates. The waiver and release contained herein protects Jet Central, and all of its employees, officers, principals, owners, designers, and agents ("Associates").

4. No Modifications to Model Engine. Buyer agrees to make no modifications of any kind to the Model Engine. This Agreement pertains to the entire life of the Model Engine.

5. Sale by Buyer to Other Party. Buyer agrees to fully inform any person to whom he/she sells or transfers the Model Engine, concerning the handling, use, and operation of the Model Engine, and agrees to give all operating instructions to such person, at or before the time of sale or transfer. The indemnity and hold harmless agreement contained in Paragraph 3 continues in effect, following such sale or transfer.

6. Severability. In the event any clause, provision, or term of this Agreement is held to be ineffective, void or otherwise unenforceable for any reason, that clause, provision, or term shall be severed from this Agreement, and the Agreement shall otherwise remain binding and effective. If any portion of Paragraph 3 is found to be unenforceable, then the parties agree that the fullest and most complete waiver and release which is permitted by law, shall be effective.

7. This Document Is the Full Expression of Parties' Agreement. This Agreement contains the full and complete agreement of the parties. There is no representation, term, or provision which is outside this Agreement. Any and all discussions, oral agreements, and representations are merged into this single written Agreement. This Agreement cannot be modified or amended in any way, except by written Amendment, signed by the parties.

8. Paragraph Headings Not Controlling. The heading to any paragraph, or subparagraph of this Agreement, shall not be dispositive, but may be used to interpret the parties' intentions.

9. No Interpretation of Agreement against Either Party. Buyer understands and expressly acknowledges that he/she has the right to have an attorney read and review this Agreement, before execution. This Agreement shall not be interpreted against either party, but shall be interpreted as if it was drafted mutually by the parties.

IF THE BUYER IS NOT PREPARED TO FULLY ACCEPT THE PURCHASE AGREEMENT, FULL ASSUMPTION OF LIABILITY AND INDEMNITY AGREEMENT, THE BUYER IS ADVISED TO RETURN THIS MODEL ENGINE IMMEDIATELY IN NEW AND UNUSED CONDITION TO THE PLACE OF PURCHASE.

2 Safety Information

JET CENTRAL turbine engines are in their own right a single stage centrifugal flow gas turbine engine, configured to operate as a turbojet engine for use mainly, but not exclusively, in remotely piloted fixed wing aircraft. Such aircraft and their control systems must be appropriately designed and constructed to be compatible with the performance of the turbojet engine.

NOTE: The airworthiness, structural design, integrity of the aircraft and its control systems are the entire responsibility of the owner/builder/operator. JET CENTRAL and its agents cannot accept responsibility for any failure, structural or otherwise, of the aircraft or its control systems. JET CENTRAL and its agents cannot accept responsibility for any inappropriate or unauthorized use of the JET CENTRAL engine.

The JET CENTRAL gas turbine engine is a very safe, easy to operate unit. The JET CENTRAL turbine is a state of the art gas turbine engine and all components are manufactured within the highest standards. If operated and maintained correctly it will provide years of reliable, trouble-free service, with low maintenance.

It cannot however, be stressed enough, that the operating instructions are to be fully understood before attempting to operate your engine. Any alterations to the engine whatsoever, without the written consent of JET CENTRAL, will render any warranty null and void and as a consequence the controlling body in your country may not grant approval for use.

JET CENTRAL gas turbines are high performance turbojet engines that need discipline and commitment to correct and safe operation. With other persons present **ALWAYS ENFORCE THE PROPER SAFE DISTANCES FROM THE TURBINE WHILE IN OPERATION.**

The recommended minimum safe distances are:

In front of the turbine: 15 feet (4.6 m)

Beside of the turbine: 25 feet (7.6 m)

Behind the turbine: 25 feet (7.6 m)

CAUTION: Extreme Suction Hazard, which can grasp a hand, fingers or other objects in a moment, prevails around the intake area. **Always be aware of this danger!**

NOTE: The supplied FOD screen must be used to maintain warranty and to reduce the hazards to operators. Additionally it will aid in the prevention of foreign materials from entering the intake of the turbine during operation. Before operation, make sure there are no loose parts or debris near the turbine. When the turbine is running never place your hands closer than 6 inches (15 cm) into the area of the intake. **FOD related damage is not covered by the Lifetime Warranty.**

CAUTION: Extreme Burn Hazard, always exercise caution around the hot parts of the turbine, to avoid burns. The outer case at the turbine stage and nozzle reaches 400 - 500°C (750 - 950 °F), while the exhaust gas may exceed 600° C (1290 °F) at the tail cone exit point. **Always be aware of this danger!**

NOTE: Fire extinguishers must be on hand at all times during turbine operation, especially during the starting sequence, the recommend type is the CO₂ variety. To avoid hearing damage, always use hearing protection when near a running turbine engine.

Make sure that the fuel is mixed with the correct amount of synthetic oil for the specific engine. **Use only 100% synthetic 2 strokes or turbine oils.** (See section 7 for details)

Use common sense when operating model turbine jet aircraft. Never operate in or around heavily populated areas, and in or around areas experiencing drought or dryness where the fire risk is high. Always check for fire risk warnings with local authorities in fire prone areas prior to operation.

2.1 Safety Rules

Rule 1 Never run your engine indoors; always make sure you are in the open air. Non-associated persons should be at least 9 meters (10 yards) away from the engine when running. Always have a fully operational CO₂ fire extinguisher available and ready for use when starting and running your engine.

Rule 2 When bench running or engine starting in an airframe; never allow yourself or another person to stand behind or in the rear quadrant of the engine. Always make sure the exhaust of the engine is directed away from persons and property as the heat of the engine exhaust can cause fire, damage, and personal injury.

Rule 3 Air will save the engine, in the event of a hot or failed start always isolate the fuel to the engine, but always keep the starter running*, this will clear the engine of residual fuel and will keep the core of the engine cool. Do not be afraid to use your fire extinguisher, a CO₂ extinguisher will not harm the engine in any way. A hand held blower is another good safety item to have on hand during the startup and shut down of the turbine, this will aid in the cooling of the turbine.

* **NOTE:** To initiate manual cooling, lower the throttle trim and raise the throttle stick to full, this will place the starter motor in manual mode, On – Stick up, Off – Stick down.

Rule 4 Never attempt to start a flooded or wet engine, this will result in a hot or wet start and you will have flames. To dry out or clear the engine, stand it tail pipe down and either run the starter motor or blow air through the engine until all residual fuel has been blown out of it.

Rule 5 Always start and shut down the engine with the nose of the plane pointed into the wind.

Rule 6 In the event of a hot start, or sever engine fire, close the throttle and the trim lever to the fully back position and turn off the fuel isolation valve, this will allow the engine to clear itself, be ready to use your fire extinguisher. A CO₂ type extinguisher will not harm the engine in any way. As a last resort; if a dry powder extinguisher is used and the powder is ingested into the engine then the Turbine must be returned to the Jet Central service department.

3 Turbine System Components Description

3.1 Parts List

Before starting installation of the engine please check the contents against the parts list. If any part is missing or damaged please contact JET CENTRAL or their agent in your country for correction. **DO NOT** substitute missing or damaged parts as this will void your warranty and your country controlling body approval for use.



Case Contents:

- 1 – Turbine Engine with integrated ECU
- 1 – SE POWERPACK Unit
- 1 – Clear Fuel Line 4mm
- 1 – Clear Kerosene Start Line 3mm
- 1 – Clear Fuel Line 6mm
- 1 – 3 Cell LiFePo Battery
- 1 – Accessory Box

Accessory Box Contents:

- 1 - On/Off Manual Festo Valve (6mm.)
- 1 – Hanger 9 Fuel Filter
- 1 – S-Bus / Power Cable
- 1 – USB Flash with Manuals
- 1 – SE Hand Data Terminal (HDT)
- 1 – JR Style Receiver throttle cable



3.2 Turbine

Jet Central Turbines utilize a design containing a single shaft turbojet with an annular combustor. The single stage axial flow turbine drives a single stage centrifugal compressor. The shaft is supported by 2 fuel/oil lubricated pre-loaded angular contact bearings. The turbine speed is controlled by the amount of fuel received from the fuel pump, which is controlled by the SE POWERPACK / ECU.

3.3 Fuel / Oil System

The fuel supply for all Jet Central Turbines requires that the user to pre mixed fuel and oil together.

Internal lubrication is achieved by routing fuel oil mix to an internal T-fitting which routes a portion of the Fuel/Oil mix to the bearings and the rest is sent to the fuel nozzles located in the combustion chamber. It is important to filter the fuel and use proper types of fuel and oil in the turbine engine. Without proper filtering one or more of the injector needles could become clogged, thus affecting the proper running of the engine.

Use the supplied hangar 9 fuel filter between the fuel pump and the turbine; this will help insure that the oil flow reducer will not be clogged. Failure to use this filter can damage the turbine by reducing the flow of fuel/oil to the rear bearing! See section 7 for fuel and oil recommendations.

3.4 Kero Start System

The initial start sequence of the turbine utilizes the main fuel source (Kerosene / Jet A / Diesel). This system uses the fuel pump and solenoid valves located within the POWERPACK module to deliver the fuel to the combustion chamber, the ceramic igniter located internally within the turbine is powered momentary to initiate ignition.

When the start command is received by the POWERPACK / ECU there will be an igniter preheat time delay, after which the starter will turn the turbine to preset RPM before the Kero Start solenoid valve will modulate, at this time the start fuel will ignite in the combustion chamber resulting in a temperature rise detected from the EGT probe.

During the start sequence if the temperature rise and RPM's are within the pre-programmed values, "Preheat" and "Switchover point", then the main fuel solenoid valve will modulate to deliver fuel to the main burner to bring the engine to the proper idle RPM during the remaining starting ramp. The Kero solenoid valve is automatically closed when the predetermined RPM is reached during the "Fuel Ramp" stage taking the turbine to the "Running" mode, where Turbine control is handed back to the transmitter throttle control.

Caution: If accidental flooding occurs; steps should be taken to drain the turbine of excess fuel before attempting the start sequence. Fuel is liquid and, if unburned, will pool inside the turbine and stay there. The turbine can hold a large quantity of fuel internally and this excess fuel will be ignited on next successful startup and will be pushed to the exhaust as soon as the airflow inside the turbine is sufficient. The exhaust will be ignited causing a hot start (in extreme cases a large fireball) that will not hurt the turbine, but can destroy the model.

3.5 Hand Data Terminal (HDT)

The HDT is a rugged, slim, compact user interface and features a 2.4" portrait mode LCD TFT color graphical display which can be easily viewed even under the most demanding lighting situations. The HDT allows for a completely new level of turbine control system monitoring, it utilizes S-Bus communications and is simple to operate. The HDT is used to monitor the available turbine information and to program parameters in the integrated Turbine ECU electronics and the POWERPACK. Please take the necessary time to learn the menus and the operation of the device.

Navigation is intuitive and is accomplished with six easy to use multifunction buttons, they consist of the following:



3.6 SE POWERPACK / ECU

3.6.1 Overview

The **SE POWERPACK and ECU** included with this Turbine engine is the next generation of integrated intelligent turbine management systems and features S-Bus communications that allows simple installation by using only one cable connection and two fuel line connections from the POWERPACK to the Turbine.

The POWERPACK contains the Fuel Pump Motor, Kero Start Solenoid, Fuel Solenoid, and Interface Electronics that communicates to the integrated ECU which is located under the Turbine's front cover.

The S-Bus communications allows for information connectivity through an optional Telemetry interface module. The ECU's main function is to control and regulate the POWERPACK fuel pump and solenoids providing the turbine with the necessary regulation of fuel for safe and controlled operation.

The ECU measures the exhaust gas temperature, monitors the rotor RPM speed, and tracks the relative position of the throttle stick. It also monitors all of the controls necessary to guarantee that the turbine operates within the user-defined / factory set parameters of operation.

If any anomalies are detected outside of the predetermined limits of the turbine the ECU will command a shutdown of the turbine.

3.6.2 Features

- New HDT rugged aluminum compact design case with 2.4" portrait mode (240 x 320 resolution) LCD TFT color graphical display with easy to use selection buttons.
- Micro SD card slot to download/upload parameters and black box data
- Black box function, records engine sensor measurements every 0.5 sec for up to 10 flights
- Barometric pressure corrections for fuel system regulation
- Brushless starter motor with electronic brake to aid with clutch disengagement
- Service interval elapsed timer
- Elapsed engine run timers
- RPM input: Magnetic sensor up to 250,000 R.P.M.
- Temperature range up to 1000°C using an internal "K" type thermocouple
- PWM (Pulse Width Modulation) pump control, resolution of 8192 steps
- Open circuit detection for the ceramic igniter
- Adjustable Kero Start parameters

3.6.3 Measurements

The measurements made by the POWERPACK / ECU are:

- Exhaust Gas Temperature (EGT)
- Turbine Ambient Temperature
- RX battery voltage
- Pump battery voltage
- Pump battery current
- Throttle pulse width
- Turbine rotor RPM
- Total turbine run time
- Air Speed, Turbo Prop RPM etc. if optional sensor(s) are connected
- Barometric pressure

3.6.4 Other functions

- Calculation of fuel used
- Calculation of ECU battery power used
- Graphical display of throttle pulse width
- Diagnostics and Alarm posting
- RPM Limit for Turboprop output shaft (with optional sensor)
- Aircraft Speed Limiter (with optional sensor)

The above measurements can be displayed on the Hand Data terminal (HDT) that is connected to the POWERPACK/ECU by the integrated S-bus cable.

The configuration/setup parameters are stored in the nonvolatile memory of the ECU. Parameter changes are supplied by the user utilizing the HDT or may be stored on a user supplied micro SD card that is inserted into the micro SD slot on the POWERPACK. Black box data may also be viewed utilizing the PC program titled “**Jet Central BB**” that is downloaded from the USB stick that was included with the turbine, the program will execute from your PC, see section 12 for details.

3.6.5 Micro SD memory slot location

The micro SD card slot is located on the bottom side edge of the POWERPACK, see section 5.11 for details.

3.7 Optional Telemetry Interface

The optional S-Bus telemetry interface that is available separately for purchase provides the communication protocol interface which allows data to be communicated to your telemetry capable radio system*. All functions available through the HDT are wirelessly accessible through the telemetry system.

*Contact your Jet Central representative or visit the Jet Central Web site for the latest information for supported telemetry systems.

4 Turbine System

INSTALLATION DIAGRAM

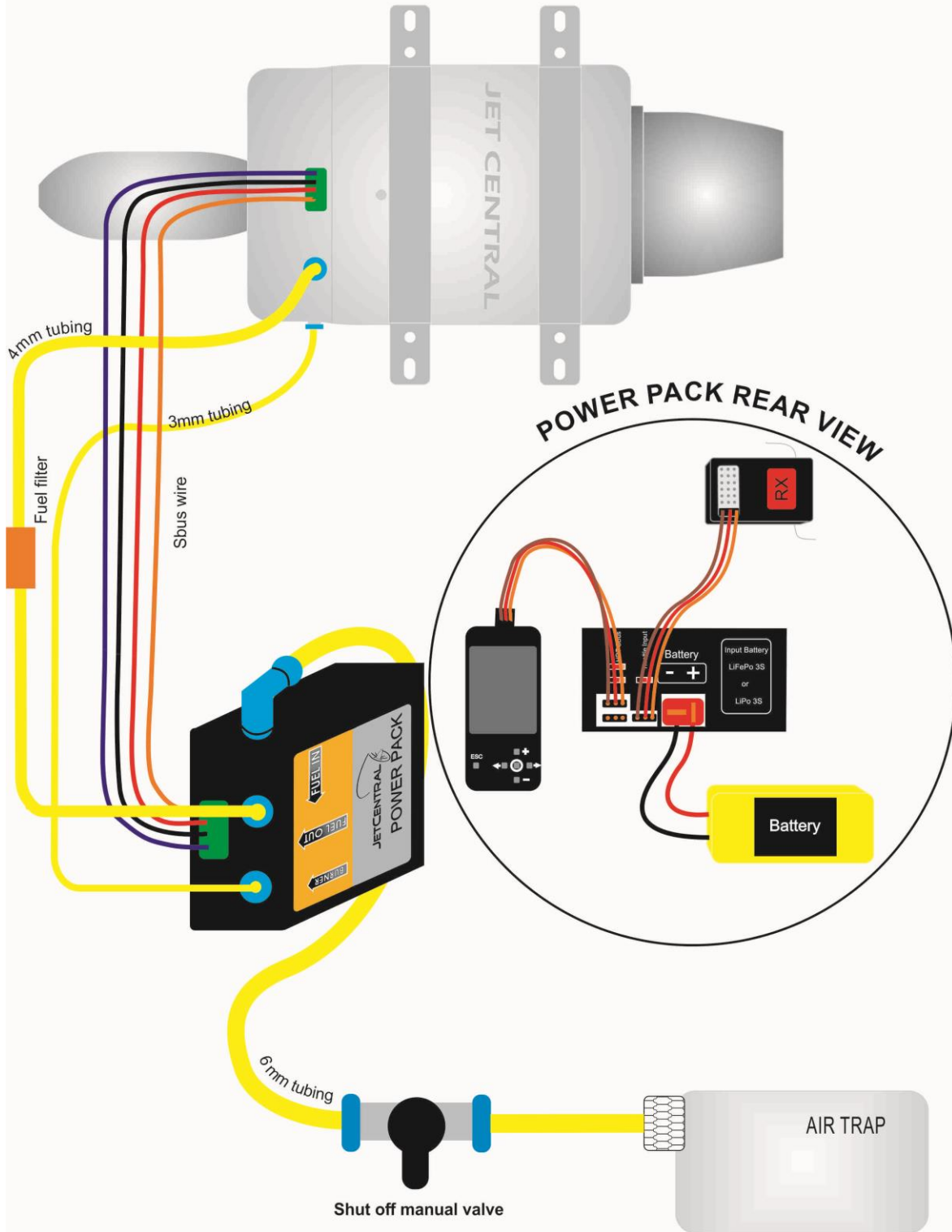

4.1 Connections to SE POWERPACK / ECU

- Throttle input from the receiver: JR type servo cable
- Deans Style Battery input
- S-BUS Multiplex connector
- S-Bus Hand Data Terminal / S-Bus Telemetry Interface / Sensor Interface
- 6 mm Fuel line inlet
- 4 mm Fuel Line Outlet
- 3 mm Burner Fuel Outlet

Connect the cables to their assigned places, **Caution:** some of the JR type connectors used can be connected in the wrong location or inverted, please double check all connections with the included drawing.

Use the colored labels on the **POWERPACK** body to connect the connectors to their assigned position. The input / output connectors have been designed to prevent damage to the internal circuitry in the case of an incorrect connection.



4.2 System Batteries

Two independent power sources are required for the operation of the POWERPACK / ECU. The first is taken from the radio receiver through the throttle servo connection; the second is the ECU battery that supplies power to the pump, starter motor, solenoids, ceramic igniter and HDT display. Use only the recommended ECU battery, the battery types are LiFePo (A123 3s) supplied, or 11.1V 3s LiPo

Warning: Reversing the polarity of the ECU battery may cause destruction of the POWERPACK / ECU semiconductors or other components.

The ECU battery does not need an on/off switch in the airframe since the ECU has an internal electronic switch which disconnects it when the power to the receiver is switched off. However; it is recommended to disconnect the ECU battery when the system will be stored for more than a month.

Note: Make sure to charge your battery properly; it is recommended to re-charge your pack after 4 flights. Always remove the ECU battery from the model before charging, always use the proper charger for the battery chemistry (LiFePo), and lastly always verify the cell count programmed into the charger before charging. Do not exceed a 2C (i.e. 2 x 3800 mAh) charge rate during charging.



Jet Central supplies and recommend 9.9v 3s LiFePo batteries, however 11.1v 3s LiPo may be used.

4.3 Receiver battery

Recommended Receiver voltage range: 5 VDC to 10 VDC

IMPORTANT! It is recommended to use 6 VDC or higher voltage supply to power the receiver / ECU; this will insure proper operation of the ECU electronics. Make sure to check your receiver and servo specifications to ensure that they are compatible with this higher system supply. If a voltage regulator is used; ensure it has the capacity to operate the completed system including servos under full loading conditions without dropping its voltage regulation. Most modern receivers and servos are designed to operate directly from two cell lithium batteries.

4.4 Radio Receiver

The POWERPACK / ECU is connected to the radio receiver like a standard throttle servo, receiving throttle control pulses and power from the receiver battery supply.

4.5 Fuel System Connections

The SE POWERPACK features the next generation fuel pump with an improved input (suction line) design utilizing a 6mm Festo style quick fitting. Connect necessary length of 6mm tube to the suction side of the pump from the fuel supply, and the 4mm output line from the Festo quick fittings to the turbine. Place the 6mm Festo manual on/off valve between the air trap and the POWERPACK. We recommend placing the manual fuel valve where it can be closed easily in case of an emergency.

NOTE: It is recommended to safety tie all non-Festo barbed type fuel fittings with 0.5 mm (.020") safety wire.

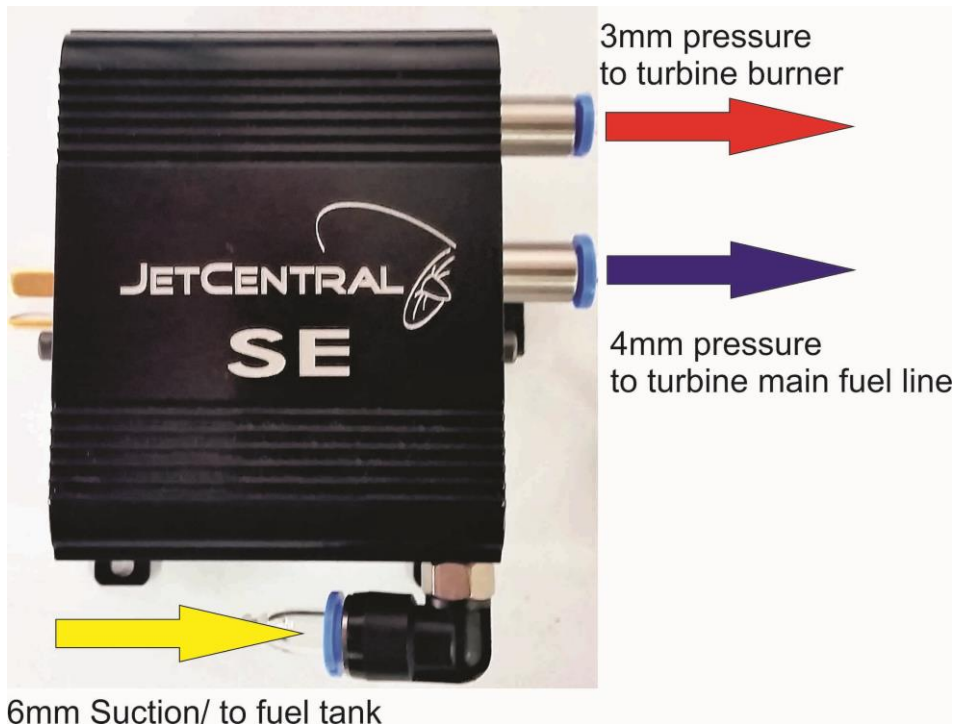

4.6 Mounting Turbine and POWERPACK

All Jet Central Turbines are supplied with pre-installed stainless steel mounting brackets; see Annex C for mounting dimensions. It is recommended to mount the turbine with the engraved name facing up. Make sure to use sufficient sized mounting hardware to secure the turbine to the turbine mounts. The distance from the tail cone to the thrust tube bell mouth should be set as per the diagram in Appendix B.

The POWERPACK should be mounted on a secure platform using the four mounting tab positions. Because the POWERPACK is an electronic device, installation in the model aircraft should be similar to that of the radio receiver. It has to be in an accessible location within the airframe, with limited vibration and far from the heat of the engine. Consideration should be made for access to the micro SD card which is located on the bottom side edge of the POWERPACK.

Additionally, because the internal pump motor may produce electrical noise when operating, it is highly recommended that the installation of this equipment be done at least 2" (5 cm) from the R/C receiver antenna.

5 Programming the SE POWERPACK / ECU

The HDT has a color LCD and five buttons which allow you to move through the various menus and to change the data settings in each menu page. The presentation of data has been organized in screens. The first screen displays the engine status readings in real time and the following screen allows the user to modify the operating parameters. All of the parameters can be modified while the engine is running, so it is easy to tune the engine without having to start it again to test the new settings. Left button (escape) allows you to move from the first screen to the submenu screen and back, the rest of the buttons are for navigation thru the screens and to change values.

5.1 Welcome Screens



When the POWERPACK / ECU is connected to the HDT, the ECU battery is connected and the RX power is turned on, the HDT display screen will briefly display "INITIALING" with the software version of the HDT displayed across the bottom of the display, and then briefly displays the Logo of the turbine that is connected, after a few seconds the main screen will be displayed.

5.2 Main Screen

RPM	79000	Actual Turbine RPM
SET	80000	Theoretical Turbine RPM
THR	35%	Throttle position
Temp	23 C	Exhaust gas temperature
Pump	0 P	Pump power value
Volt	10.01 V	ECU battery voltage
Amp	1.00 A	ECU current consumption
<p>When red, burner is on</p> <p>When green, pump and fuel solenoid are operating</p> <p>Turbine status.</p> <p>Turbine messages.</p>		<p>When blue, starter is engaged</p> <p>When green, pump and burner solenoid are operating</p> <p>Turbine model.</p>
	<p> GLOW STARTER</p> <p> FUEL_V KERO_V</p> <p>RUNNING</p> <p>TRIM UP</p> <p>CHEETAH</p>	

5.3 Menu Screen

By pressing the escape button the menu screen will be displayed.

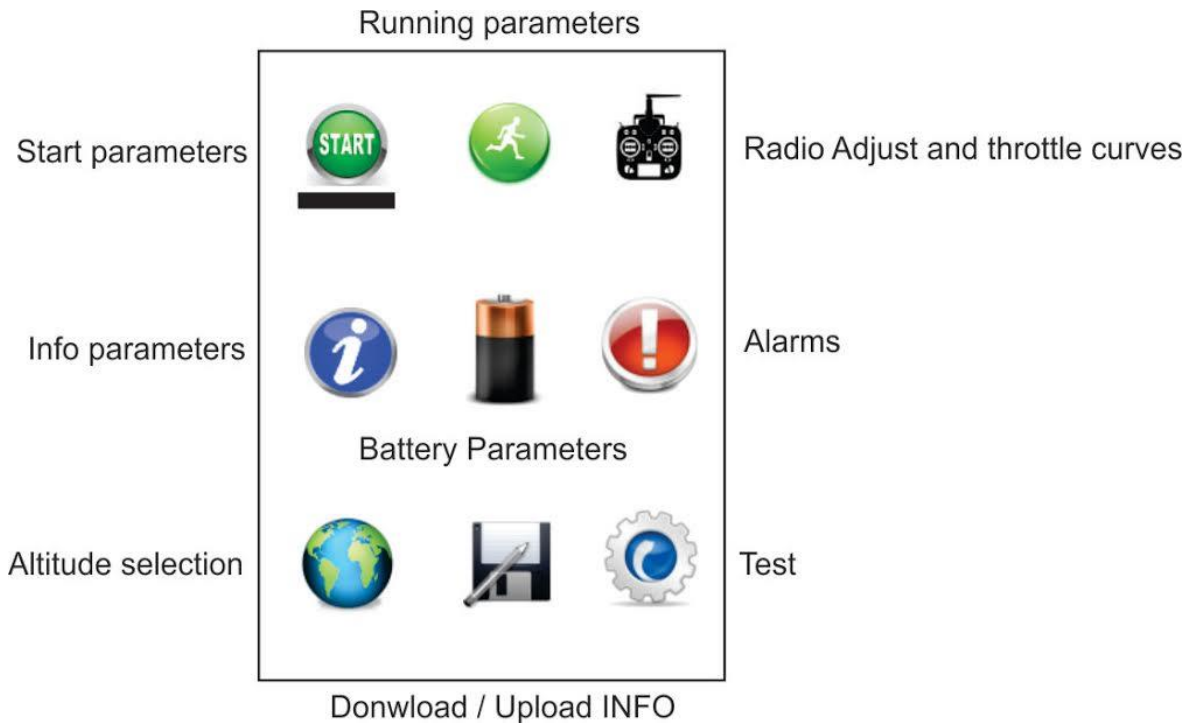

To access each menu, simply move the cursor (black bar) with the arrow buttons to underline the menu and push the “OK” button.

All the parameters in the submenus are factory pre adjusted and are a good starting point to fine tune your engine.

Note: Only make small changes at one time when adjusting the turbine parameters. Before making any changes it is recommended to down the factory settings to a user supplied micro SD card in case the original settings need to be restored. See section 13 “Memory Menu” for instructions.

5.4 Starting Parameters Sub-menu

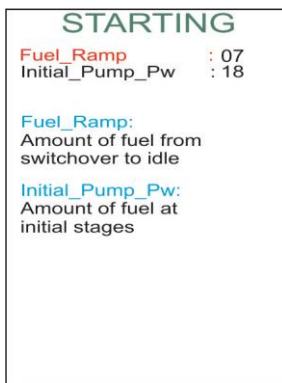

There are only two adjustable parameters in this sub-menu, “Fuel Ramp” values and “Initial Pump Pw”.

“Fuel Ramp” is the amount of fuel delivered from the end of “Switch over” to “Idle”. Range of settings is between 0 and 20.

“Initial Pump Pw” is the amount of fuel delivered during the “Ignition”, “Preheat” and “Switch over” sequence. Range of settings is between 0 and 99.

Increasing the values will increase the amount of fuel delivered during the starting sequence, so if in any of the stages you see excessive flames, reduce the corresponding value.

An “Initial Pump Pw” value that is too low will probably allow ignition of the fuel but it will not be enough to raise the temperature to sequence to the preheat mode. If you hear or see flames inside the turbine but still get an “Ignition fail” alarm, increase this value one point at a time until it creates a sufficient temperature change to sequence to the next step.

A low “Fuel Ramp” value will cause an excessively long time for the turbine to reach the idle state.

5.5 Running Parameters Sub-menu

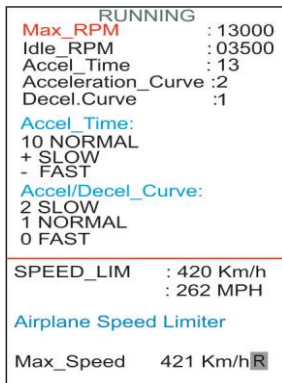

The top section of the Running Parameters sub menu has five user adjustable parameters:

Max RPM: you can lower this value but you cannot increase it above the factory setting, lower this value to reduce the available output power (see RPM/thrust chart in Appendix A)

Idle RPM: you can increase this value but cannot decrease below the factory setting.

Acceleration Time: lowering this value will make the turbine response more aggressive in the first half of the RPM range. Range of settings is between 0 and 20.

Acceleration Curve: lowering this value will make the acceleration more aggressive in the second half of the RPM range. Range of settings is between 0 and 2.

Deceleration Curve: lowering this value will make the deceleration faster from a high RPM setting to a lower RPM setting. Range of settings is between 0 and 2.

CAUTION: Aggressive settings in either direction may cause a flameout or excessive flames which could start an on board fire.

5.5.1 Air Speed Limit / Turboprop RPM Limit

The lower part of the Running Screen normally displays a speed limit setting which is programmed by the user; these settings will only be active when the optional Pitot sensor is connected to the S-Bus port. The lowest display line will indicate the maximum speed achieved during the flight, this can be reset by highlighting the “R” and pressing enter.

When a Turbo Prop version Turbine is detected, the lower section of the Running Screen menu will automatically display a RPM limit setting which is programmed by the user, these settings will only be active when the optional RPM sensor is connected to the S-Bus port. The RPM limit setting limits the Turboprop output shaft RPM by decelerating the turbine if required. The display will indicate the maximum RPM achieved during the flight; this can be reset by highlighting the “R” and pressing enter.

RUNNING		RUNNING	
Max_RPM	: 13000	Max_RPM	: 13000
Idle_RPM	: 03500	Idle_RPM	: 03500
Accel_Time	: 13	Accel_Time	: 13
Acceleration_Curve	: 2	Acceleration_Curve	: 2
Decel.Curve	: 1	Decel.Curve	: 1
Accel_Time:		Accel_Time:	
10 NORMAL		10 NORMAL	
+ SLOW		+ SLOW	
- FAST		-FAST	
Accel/Decel_Curve:		Accel/Decel_Curve:	
2 SLOW		2 SLOW	
1 NORMAL		1 NORMAL	
0 FAST		0 FAST	
SPEED_LIM	: 420 Km/h	RPM_LIM	: 8000 RPM
	: 262 MPH	RPM_LIM:	
Airplane Speed Limiter		Turboprop Maximum RPM	
Max_Speed	421 Km/h R	Max_RPM	8100 RPM R

5.6 Radio Adjustment Sub-menu

IMPORTANT – Please Read

Before starting the process to learn the transmitter throttle settings, it is important that the transmitter be cleared of any and all programmed Mixing or FAILSAFE parameters that might have programmed to the throttle channel since this can interfere with the proper programming of the POWERPACK / ECU throttle settings.

The throttle channel end point adjustments should be set to +100 and -100 before proceeding.

Do not program the failsafe until after you have programmed the POWERPACK / ECU to learn your transmitter throttle settings.

5.6.1 Transmitter Setup

RADIO	
For adjust press OK	
For exit press ESC	
For curve adj press DOWN	
RX	2047
Fail Idle	Full
Trin_Up, Throttle_Down & OK	
Trin_Up, Throttle_Up & OK	
VALID ADJUST	
LINEAL THRUST	
HALF EXPO THRUST	
EXPO THRUST	

5.6.1.1 Transmitter Preparation and Verification

The radio screen features an indication of the transmitter channel current throttle stick position by using a graphical slider display of the Pulse Width value; the actual pulse width value will also be displayed numerically in milliseconds (mS). Verify that the throttle stick movement is correct from end to end and is fast. Once the transmitter has been verified, the learning process can be started for the POWERPACK / ECU.

Note: The transmitter must not have any reduction of throw, trim, slow movement, center value, or the linearity modified.



Note: For FUTABA systems you must reverse the throttle channel, Jeti and JR systems require non-reversed settings, other systems will require verification using the graphical display in the Radio Menu.

5.6.1.2 Programming throttle position

To program the throttle stick position value into the ECU select “Ok” on the HDT.

Move your transmitter trim up all the way and your throttle stick down; then press “OK” on the HDT.

(You will notice that the end of the RX bar has move to match the beginning of the blue bar)

Keep your trim up and your throttle stick up and push “OK”

(You will see that the end of both bars are matched)

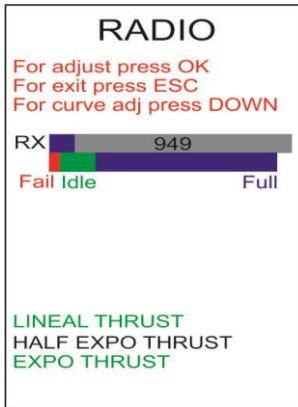

Lower the trim and you have to see that the RX blue bar stays in the green zone, if it goes too far to the red zone you need to lower your end point so it stays in the green zone

If there is an error with the throttle programming a “Throttle Error” message will be displayed.

Follow your radio manufactures instructions for setting the throttle “Fail Safe” value.

Note: Always verify the fail safe setting after programming your radio, if set properly the Rx bar graph will drop to the fail safe region (Red Zone) on the graph when the transmitter is powered off while the Rx is still powered.

5.6.2 Throttle Curves

Turbine engines develop the thrust in exponential mode, thus half RPM means approximately 1/4 of thrust. On small engines with a high idle to full power RPM ratio, or in a high drag/low power planes, often only the last 1/3 of the throttle stick produces significant thrust, with the low half stick travel being not used.

5.6.3 Types of Throttle Curves

FULL EXPO: Means linear RPM, it is the default setting and the mode used for all previous software versions. Thrust develops exponentially, and it is the recommended curve for big engines and/or high thrust/weight ratio planes, as it eases the control in low power used during taxi.

LINEAR: Means that the thrust develops linearly with the throttle settings. It could cause difficult taxi, as it would be difficult to fine adjust the power at low settings.

HALF EXPO: An intermediate setting between the other two modes.

		STICK POSITION					
MODE	0% (idle)	25%	50%	75%	100%		
FULL EXPO	Idle thrust	6%	25%	56%	100%	% of total thrust	
HALF EXPO	Idle thrust	16%	38%	66%	100%		
LINEAR	Idle thrust	25%	50%	75%	100%		

To select your curve preference, push down arrow and highlight the curve of your choice and push OK

5.7 Info Menu

The info menu is used to display the Total Time, Service Time, Turbine Serial Number, and the Software Version of the Power/Pack ECU.

INFO
TOTAL TIME 004:54:46
SERVICE TIME 004:54
SERIAL NUMBER: JCGL-40001
SOFT VERSION: 08.10

“TOTAL TIME” is the running time since turbine fabrication

“SERVICE TIME” is the running time since last service; this time is reset to zero whenever the Turbine is returned to the authorized Jet Central service facility for the 25 hour service procedure.

5.8 Battery Menu

The top portion of the battery menu display indicates the RX Battery Voltage, ECU Battery Voltage and the current (in Amps) being consumed from the ECU battery.

BATTERIES	
V_Rx	5.02 V
V_ECU	10.01 V
Amp	0.20 V
BATTERY	
44% R	
Battery_Capacity	:02100
Battery_Type	:LiFe
FUEL	
100% R	
Tank_Capacity	:03000
Consum_Correction	:000 %
ml_Correction	: 0

In the center of the display menu there are two settable parameters, “Battery Capacity” and “Battery Type”. The selections for Battery Type are “LiFe” or “LiPo”, capacity should be set to match the ECU battery.

Press reset “R” every time you fully recharge your ECU battery and it will indicate remaining capacity, it is recommended not to fly with less than 25% remaining capacity.

On the bottom of the display is a fuel consumption calculator, and was designed to transmit remaining fuel data back to the pilot on systems equipped with telemetry.

To set the fuel consumption calculator, enter the fuel tank capacity in milliliters units and fly a normal flight, at the end of the flight check the remaining amount of fuel in the tanks and enter the value in the “Consum_Correction”.

The ECU will calculate your remaining fuel in tanks with a +/- 5% accuracy.

If a taxi tank is being utilized and it is desired to reset to 100% capacity after disconnecting the taxi tank and prior to take off, there are two ways to achieve this:

- The preferred method is accomplished by moving the throttle stick from idle to full and back to idle very quickly, (i.e. in less than one second), this movement will not increase turbine RPM’s and it will set the tank capacity back to 100%.
- Another method is selecting the “Batteries” Menu on the HDT, highlight “Fuel” and press “R”

5.9 Alarm Display

This menu displays the two basic alarms types; Stop Alarms and Info Alarms, additionally in the bottom of the display there are two Status Information lines, the top Blue line are Turbine Status codes and the Bottom Red Line are the Alarm status messages

5.9.1 Stop Alarms

STOP AL	INFO AL
<input type="checkbox"/> Rpm Sens	<input type="checkbox"/> Temp_Sens
<input type="checkbox"/> Low_Rpm	<input type="checkbox"/> Low_Temp
<input type="checkbox"/> Com_Error	<input type="checkbox"/> Max_Temp
<input type="checkbox"/> Fail safe	<input checked="" type="checkbox"/> Batt_Rx
<input type="checkbox"/> Rx_Error	<input type="checkbox"/> Bat_ECU
<input type="checkbox"/> Fuel_Error	<input type="checkbox"/> Acc_Error
	<input type="checkbox"/> Max_Pump
	<input type="checkbox"/> Over_Amp
	<input type="checkbox"/> Service
	<input type="checkbox"/> Void_Waran
STOP	
TRIM DOWN	

Stop Alarms appear when the problem was significant enough that the ECU command the turbine to stop during a run cycle.

“**RPM_Sens**” indicates an RPM sensor failure.

“**Low_Rpm**” indicates that the RPM dropped below the minimum programmed RPM.

“**Com_Error**” indicates a communication error between the Turbine electronics and the PowerPack.

“**Fail Safe**” indicates that the RX signal went outside the programmed limits.

“**Rx_Error**” indicates complete loss of the pulse signal from the receiver throttle channel.

“**Fuel_Error**” indicates that fuel delivery was interrupted, for example a bubble in the system.

5.9.2 Info Alarms

Info alarms indicate that there were one or more errors detected during last run.

Note: The turbine must reach the running stage for info alarms to be registered.

STOP AL	INFO AL
Rpm Sens	Temp_Sens
Low_Rpm	Low_Temp
Com_Error	Max_Temp
Fail safe	Batt_Rx
Rx_Error	Bat_ECU
Fuel_Error	Acc_Error
	Max_Pump
	Over_Amp
	Service
	Void_Waran

STOP
TRIM DOWN

“**Temp_Sens**” indicates a temperature probe failure.

“**Low_Temp**” indicates that the running temperature dropped below 100°C.

“**Max_Temp**” means that temperature exceeded 900°C

“**Batt_Rx**” Indicates that voltage from RX dropped below 4.5 volts.

“**Bat_ECU**” means that ECU battery voltage dropped below 8.4 volts.

“**Acc_Error**” appears when turbine is about to flameout because of a too aggressive acceleration setting. When this happens the ECU automatically increases the “acceleration time” parameter by 1 point.

“**Max_Pump**” means that the pump reached its maximum power setting without reaching the maximum turbine RPM.

“**Over_Amp**” indicates that the ECU current consumption exceeded the maximum programmed limit.

“**Service**” indicates that the 25 hours of running time has elapsed and it needs to go back to service immediately.

“**Void_Waran**” is displayed when 28 hours of running time has elapsed without service; the Jet Central warranty is void at this point.

5.9.3 Turbine Status Messages

In the main screen you can see the status messages displayed in **Blue** text, they will indicate what the turbine is doing during start up and running, status codes are as follows:

Manual Cooling	To initiate manual cooling lower the trim and raise the throttle to full.
Auto Cooling	When the EGT temperature is over 100°C and trim and throttle stick are in low position, auto cooling will engage, if you aborted a startup, you need to cycle the trim from low to high back to low.
Igniter heating	When the internal ceramic igniter is powered, pre heat time is factory set for 5-8 seconds.
Ignition	Kerosene ignition phase and the heating of the combustion chamber.
Preheat	An increase of rpm and fuel occurs to increase temperature inside the turbine.
Switchover	Phase of switching the kerosene feed from igniter to normal injectors.
To Idle	The phase of the acceleration cycle prior to idle speed being reached.
Running	Turbine working correctly, throttle control passed back to transmitter stick.
Stop Error	Start process aborted by alarms.
Stop	Normal Turbine shut down via user command (Tim Low , Stick Low).

5.9.4 Turbine Alarm Messages

Turbine Alarm messages appear as **Red** Text on the bottom of the display.

Ignition error	Temperature failed to increase by 8°C during ignition sequence.
Preheat error	Temperature failed to increase over 80°C during preheat.
Switchover error	An abnormal drop of RPM or temperature during switch over phase.
Starter motor error	No rpm reading when starter is engaged.
To idle error	Turbine did not reached idle in a predetermined time
Acceleration error	Turbine did not increased rpm in a normal fashion
Igniter Bad	Open circuit detected in igniter circuit.
Min pump ok	Minimum pump pulse width value is stored.
Max pump ok	Maximum pump pulse width value is stored.
Low RX Battery	Rx battery below minimum set point voltage.
Low ECU Battery	ECU battery below minimum set point voltage.
No_RX	Missing signal from Receiver.
Trim down	Radio Trim Lever is in the low position.
Trim Up	Radio Trim Lever is in the high.
Failsafe	Throttle pulse width below the low set point value, Tx signal lost.
Full	Throttle position and turbine are at maximum speed.
Temp sensor error	Thermocouple open circuit.
Com Turbine error	Communication error between ECU electronics and POWERPACK.
Max temp	Temperature value exceeded programmed maximum value of 800°C.
Max amperes	ECU Battery current drain exceeded preset limit of 30 amps.
Low RPM	RPM dropped below pre-established value.
Error RPM sensor	RPM sensor failure.
Max pump	Pump PW reached its maximum power.

5.10 World Menu

WORLD	
Altitud Selection	: 2
Altitud Selection	
0=from 0 to 800 mts	
1=from 800 to 1600 mts	
2=from 1600 mts onwards	
Amb Temp:	32 C
Baro. Press:	776 HPas
Altitude:	2192 mts
Performance:	72 %

This menu is used to set the local operating altitude from sea level measured in meters.

To set the local altitude enter the value corresponding to your local altitude, the values are 0 through 2, the ECU measured altitude which is displayed on the lower section of the display should be used as a reference.

Adjusting it accordingly will improve the performance and correct possible running issues.

The ECU has built in temperature and altitude sensors; this information is to be taken just as reference only.

The last line is the calculated expected performance of the turbine under these conditions.

5.11 Memory Menu

BLACK BOX	
Download Last Fligh	
Download 2 Flights	
Download 1 hour Fligh	
Download 2 hours Fligh	
Download Parameters	
Upload Parameters	

The Memory menu is used to download Turbine performance flight data to a user supplied micro SD card. The choices consist of: Last Flight, Last 2 Flights, 1 Hour Flight data, or 2 Hours of Flight data.

The "Download Parameters" function is useful to make a back-up copy of the turbine parameters. Additionally if there are running issues which require special factory parameter changes the parameters can be emailed to Jet Central for analysis, the new revised parameters can be sent back for uploading into the POWERPACK/ECU using the "Upload Parameters" function.

5.11.1 Using the micro SD Card

The recommended micro SD card size is 512 mb or larger. To download files from the POWERPACK insert the user supplied micro SD card with the gold contacts facing towards the top of the Power Pak.

To remove the micro SD card from the POWERPACK, push in and release, and it will eject.

See section 12 for details about the operation of the PC program Jet Central BB to view the recorded flights. Insert your micro SD card into an appropriate reader connected to your PC to read the files that were downloaded from the POWERPACK.

5.12 Test Menu



This screen features diagnostic tools to aid in the installation and testing the various turbine systems, in particular the priming of the fuel and burner lines.

Select the desired test by using the up/down arrows and use right arrow to start the selected function and left arrow to stop the selected function.

Important: The Throttle Stick and Trim must be in their lowest position for the test settings to function properly. If the “TRIM DOWN” message is not displayed on the bottom left side of the display then the Test functions will not operate.

If the Rx is powered up without the transmitter no message will be displayed below the “STOP” message, or if the transmitter is shut down while the Rx is powered the “Fail Safe” message will be displayed, if Fail Safe has been programmed, otherwise the last trim position will be displayed.

6 Turbine Starting

6.1 Preparing the Turbine for Installation

It is a recommend practice to always test the turbine on a test bench before installing into an air frame. This will confirm that all systems work as they should, and will allow the operator to learn the operation and associated emergency procedures. A suitable platform/table/workbench is required to clamp the test turbine stand onto it. Make sure this can be easily transported outside and weighs enough to ensure it cannot be toppled over by the thrust of the engine.

Select a clear area for running – keep clear of areas with loose leaves, sand or other debris that could be picked up or drawn towards the intake. Ensure the fuel tank and associated equipment is position well clear of the exhaust area and is secured.

6.2 Important notes

The kerostart system used on all Jet Central turbines is reliable and well tested system that produces very smooth and trouble free starts. However, extra care and attention must be paid when starting a kerostart turbine.

Fuel is liquid and, if unburned, will pool inside the engine and stay there. The engine can hold a large quantity of fuel inside. This fuel will be ignited on next successful startup and will be pushed to the exhaust as soon as the airflow inside the engine is sufficient. This action will cause the fuel to be ignited in the exhaust, causing a hot start (in extreme cases a large fireball) that will not harm the turbine, but if left unchecked can destroy the model or the thrust pipe assembly.

To help minimize the chance of a hot start the following should be performed:

- During the start-up, listen to the turbine sound to check for positive sound of ignition, verify by looking into the exhaust to verify that the fuel is burning, or check for an increase in EGT temperature by observing the display on the HDT.
- If a small plume of white smoke is emitted from the exhaust it is an indication that the fuel is not burning and may be an indication that the raw fuel is pooling inside of the turbine. In this case the start sequence should be aborted immediately.
- After a failed start, or whatever condition could cause fuel to be collected inside of the turbine (i.e. extra priming), ALWAYS empty the turbine of raw unburnt fuel by rotating the turbine to point nose down. Fuel will exit through the intake. Do not tilt upwards, due at the internal engine construction the fuel cannot exit through exhaust.

Caution: Fuel may keep burning for a long period of time inside the turbine. This situation usually happens during an aborted start, for example, if the start-up sequence is aborted by the user or automatically before the engine reaches the idle state. This condition can cause the excess fuel inside the engine to keep burning and could destroy the engine or the model if left uncontrolled.

If a start-up sequence is not completed, always check for flames or excessive raw fuel inside the turbine.

If there are flames, **lower the trim and raise the throttle stick to full** to engage the starter motor to help blow them out. In the case that the start-up procedure has been aborted due to a starter motor failure, then it will be necessary to discharge the CO₂ fire extinguisher into the turbine intake. White smoke from the turbine exhaust is a good indication that there is no fire inside of the turbine combustion chamber.

Note: Do not be afraid to use the CO₂ fire extinguisher as required as this will not harm the turbine or void the warranty.

6.3 Priming

Both main fuel and starting fuel lines require the purging of all air after initial installation. Take extra care when priming the lines; ensure that excess fuel is not pumped into the turbine.

Reference section 5.12 Test menu to choose the fuel line you need to prime, i.e. Prime Fuel or Prime Burner.

Click on right arrow to “On” and left to “Off” to start/stop the pump manually. Please observe fuel line to engine very carefully and push the off button to shutoff as soon as fuel reaches engine. Repeat the same operation on the burner line by the appropriate menu entry (Prime Burner), except that after stopping the fuel when it reaches the turbine case restart the prime for an additional three seconds to get the start fuel down to the igniter. If this step is not completed a series of “start bad” errors may occur until the fuel reaches the igniter.

IMPORTANT:

The prime procedure should be done only to fill the fuel tubes and filters in the case of a first installation or in case of disassembling of the fuel lines. Do not run the prime function so that the engine becomes flooded by fuel, as this will cause an uncontrolled fire (Hot Start) at next startup.

6.4 First engine runs

- Confirm your test stand is securely fixed to a bench or heavy table. Secure your ear protection and keep a CO₂ fire extinguisher handy. THIS IS VERY IMPORTANT ON KEROSTART ENGINES.
- Fill the fuel tank. Do not forget to filter the fuel, and to mix the oil.
- Confirm all batteries are freshly charged and connected up. Use only a three cell battery for the ECU.
- Check there is a temperature reading on the data terminal.
- Ensure the running area is clear of onlookers – especially the prohibited zone of a 10 meter radius 180° arc from engine center around the rear.
- Verify that the fuel lines are full of fuel and purged of all air, if not; carry out the fuel prime sequence as described here.

6.5 Starting procedure

Set the throttle stick down and the trim up. "Idle" - Confirm that the screen shows "Ready" - Ready to start!

Move the stick to full throttle and then back to idle again. The POWERPACK / ECU will begin the startup sequence as described below:

First the internal ceramic igniter will be energized, (Burner indicator will turn red on the HDT display), and after 6-10 seconds, depending on the turbine, the starter will be engaged, (Starter indicator will turn blue on the HDT display), this will bring the rotor to 3000 to 7000 RPM; also depending on the turbine model.

Once the rotor is at speed, the internal pump and solenoid valves will be energized in pulsating mode, each valve indicator will turn green when activated.

A few seconds later the kerosene will ignite and the exhaust temperature will begin to increase. The rpm and pump power will increase automatically. During this phase the HDT will display "Ignition".

When the exhaust temperature has a steady increase, the data terminal reading will change to "Preheat", when 80°C is reached it will change to "Switch Over", during this phase the fuel will be routed to main injectors and the speed of the rotor will be progressively increased.

Once the switch over phase is finished, the reading will be "To Idle". In this phase the engine receives fuel only through its normal fuel input, and battery power to the internal ceramic igniter will be disconnected. The fuel flow and starter power will be increased automatically to increase the RPM up to idle RPM. When the preset RPM value is reached (depending on the turbine), the POWERPACK / ECU will automatically disconnect power to the starter.

When the rotor speed reaches the programmed idle RPM, the screen will change to "Running" and the engine speed will become stabilized.

The turbine is running!

Control of turbine power/rpm is now handed back to the transmitter and controlled by the position of the throttle stick.

It is recommended to leave it at Idle until you see a brief message of "Min. Pump Ok" which means that the ECU has learned the minimal pump pw needed

Increase the throttle slowly to full throttle setting, verifying that the engine accelerates. Leave at full throttle to verify that turbine has reached max RPM, if not; keep it at full throttle until signal the “Max Pump OK” is briefly displayed.

6.6 Engine shut down procedure

To shut down the engine lower the trim and the throttle stick. Is recommended that before shutting down the engine please restrain the model then raise the throttle stick to approximately 25%, allowing temperatures to stabilize for around 5 seconds before carrying out the shutdown procedure.

Note: Trim must be in the lowest position for the Auto Cool down to work.

At this moment you can turn Off the Rx and transmitter and the turbine will continue the cool down sequence until the temperature transitions below 100° C, at this point it will turn the starter motor off.

6.7 What to do in case of an Emergency

During the start sequence the POWERPACK / ECU will be in control of all associated turbine functions, controlling temperature and RPM. The only thing the user can do is to abort the sequence by lowering the trim in case something abnormal occurs (excessive flames in the exhaust, etc.).

If a problem is detected, first:

MOVE THE TRIM TO THE LOW POSITION TO ABORT THE SEQUENCE.

If there is a fire in the engine and the problem is because the starter has failed or the engine is seized (not turning),

IMMEDIATELY APPLY THE FIRE EXTINGUISHER through the intake side of the engine, never trough the exhaust.

If there is a fire, and the turbine rotor remains free to spin, raise the trim and lower it back, the starter will engage in a second to cool down the engine and blow out the flames. If the temperature is below 100°C and there are still flames, raise the throttle stick to the full power position, this will connect the starter manually to ventilate the engine and extinguish the fire. The throttle channel acts as a starter switch if the temperature is lower 100°C after an aborted start.

7 Fuel, Oil and Fuel System Care

7.1 Recommend Fuel

Your JET CENTRAL micro turbine can burn deodorized kerosene-k, kerosene, Jet-A or Diesel for fuel; the fuel must be mixed with oil as follows:

7.2 Recommend Oil

Jet Central recommends using 2 stroke 100% synthetic oil mixed in 1.5% (66-1) to 2% (50-1) ratios. Any recognized brand that meets the norm “JASO FC” will work. Another alternative is 100% synthetic turbine oil mixed in ratios from 2.5% (40-1) to 5% (20-1); however this type of oil is not recommended from a health and safety aspect because it's been proven to be toxic. The last alternative is Mobil DTE light with a mixing ratio of 5% (20-1).

7.3 Fuel Filter

You may use an additional onboard filter beyond what is shown in the diagrams if you wish. We recommend the use of an automotive type filter and filter the fuel before it goes into the tank.

7.4 Header Tank

Jet Central recommends a header tank with some type of bubble eliminator or an Orbit clunk. This is a requirement if you want to take every possible measure to insure against flame outs.

7.5 Fuel Line

Jet Central recommends to safety tie all barbed type fittings with 0.5 mm (.020") safety wire.

7.6 Tanks

Always use a gasoline compatible stopper for the fuel tanks; Dubro style and Kevlar fuel tanks typically have the best impact resistance. Always use large size brass tubing for pick up and vent connections, this ensures low resistance fuel flow which is important on larger turbines.

8 Multiengine Installation

For multiengine installation, first set up each turbine as per manual, start and run each engine separately. Then, when the Turbines are starting and running smooth, plug the throttle leads from each of the **POWERPACK / ECU's** into a "Y" connector and plug the central lead into your throttle channel. Now both turbines will start at the same time and shut down at the same time. This is preferred over individual starting and is a simple way of assuring you're taking off on both turbines!

Helpful Tips

- If one turbine starts and the other doesn't for any reason, just cycle the throttle again; the one not running will enter the re-start sequence.
- In multiengine installations always connect each turbine to its own separate fuel system.

9 Maintenance

Due to being an advanced design it will become evident that your **JET CENTRAL** turbine needs less maintenance and when properly cared for will provide many hours of enjoyment. Jet Central Turbines feature state of the art bearing systems, precision made combustion chambers, and high efficiency turbine wheels that take heat and load of the main components thus greatly extending service life. If you find yourself needing service just call your representative to make arrangements, see section 20 of this manual for further details or visit the Jet Central web site.

We have special processes in place to provide quick turnaround for any service requirement and for all major repairs your JET CENTRAL Turbine is serviced in the ISO 9000 factory where it was originally assembled. This ensures a quick turnaround, quality workmanship, and keeps major repairs to the minimum possible cost.

Warranty - in order to maintain the lifetime warranty the turbine must be returned to the factory for inspection and service at 25 hour intervals, the new SE HDT display makes it easy to know when service is due with the time to service clock feature. The cost of this service is a labor fixed fee (ask your dealer for pricing) any parts needed will be at no charge (see warranty terms and conditions in section 15 of this document)

10 Troubleshooting

PROBLEM	CAUSE	SOLUTION
When raising the throttle trim of the radio, the "Trim Up" message does not appear	ECU in stop mode after running. Incorrect adjustment of radio transmitter. ECU Battery supply failure.	Power cycle the Receiver by switching off and then on. Program the parameters of the radio. Verify battery voltage, check connectors.
After cycling the throttle stick (initiate start sequence) "Igniter Bad" message appears	Igniter or driver circuit bad.	Check wiring and battery connections.
After cycling the throttle stick the starter motor does not spin and later the "Starter Motor Error" message appears.	Brushless starter motor may be bad or the brushless motor drive circuit may be bad. ECU Battery Voltage low	Check starter. Charge ECU Battery Check starter clutch o-ring
After cycling the throttle stick the starter motor turns but the "Error RPM Sensor" message appears.	Starter battery power to low. Turbine hard to spin RPM sensor failure.	Check ECU battery. Check that the starter runs freely, look for ny interference that may cause a rub on one of the rotating components,. Check RPM sensor reading.
The Starter RPM cycles but the kerosene doesn't ignite, "Ignition Error" message is displayed, then the status message "Manual Cooling" is displayed followed by a "Stop Error".	Kero start tubing not purged of air Not enough fuel being supplied to burner	Purge tubing using "Prime Burner" function. "Initial Pump Pw" parameter will need to be adjusted to a higher value. This will require a power cycle of the ECU.
HDT does not light up when Rx is power on	ECU Battery not connected Serial Cable plug in backwards Low battery voltage	Connect ECU Battery Verify serial cable polarity Charge batteries
HDT stays at "Initializing"	No communications between turbine and POWERPACK	Check S-Bus wires and connections
Test and prime functions do not work	Trim Down status condition not properly set	Check or perform the transmitter setup, check you have the trim low on the transmitter and a "Trim Down" message at the main screen

PROBLEM	CAUSE	SOLUTION
After initiating a startup cycle nothing happens	ECU is not getting proper signal from Receiver	Check or perform the transmitter setup, check you have the trim up position on the transmitter and the "Trim Up" message is displayed in the status line
Start initializes but after some time the "Ignition Error" message is displayed	Not enough fuel is getting to turbine or too much fuel is cooling down the igniter	Check all fuel lines are properly primed, verify the fuel valve is open, increment the "Initial pump" value in the start menu, if there is smoke, reduce the "Initial pump" value in the start menu
Switch Over Error or Preheat Error alarms are displayed	The temperature dropped beyond the programmed threshold	Increment the "Initial pump" value in the start menu, check there are no air bubbles in the fuel line
To Idle Error is displayed	EGT Temperature dropped or the programmed maximum allowed time was reached	If excessive flames are present during this stage, reduce the "Initial pump" setting. If no or low flames are present at this stage, Increase the "fuel ramp" in the start menu

11 Optional Accessories

11.1 S-Bus Pitot speed sensor

The S-Bus Pitot speed sensor uses dynamic pressure to measure the true airspeed of the aircraft. Pressure is measured using a pitot tube by finding the difference in ram air pressure and the static air pressure. See instruction manual supplied with the sensor for full details and specifications.

11.2 S-Bus Turboprop RPM sensor

The S-Bus Turboprop RPM sensor is used to measure the rotational speed (RPM) of Turboprop propeller. See instruction manual supplied with the sensor for full details and specifications.

11.3 S-Bus Telemetry adaptor

S-Bus Telemetry adaptor is used to interface the POWERPACK/ECU to the various radio manufactures supported protocols. See instruction manual supplied with the adaptor for full details and specifications.

12 Jet Central BB Software

12.1 Introduction

This application is included to provide a PC interface program to allow user viewing of the data from the SE POWERERPACK/ECU Black Box feature, see section 5.11 for details.

The software is required to be installed on a PC running Windows 7 or higher, with 1 GB of RAM and 100 KB of free disk storage space. The software is supplied on the USB stick that was included with the Turbine or it can be downloaded from www.jetcentral.com.mx.

The program may be launched from the included USB stick, stored on your PC desk top, or other file location of your choice.

The application displays the following information in graphical chart form in the top half of the display and numeric tabular form in the bottom portion of the display:

Throttle %, Pump PW, EGT Temperature, ECU Battery Voltage, Set Point, and Turbine RPM.

Additionally the Total Run Time and Time Remaining until next service is due are displayed in Hours and Minutes. The Turbine serial number is displayed in the lower right hand corner of the display and will be required when inquiring about service..

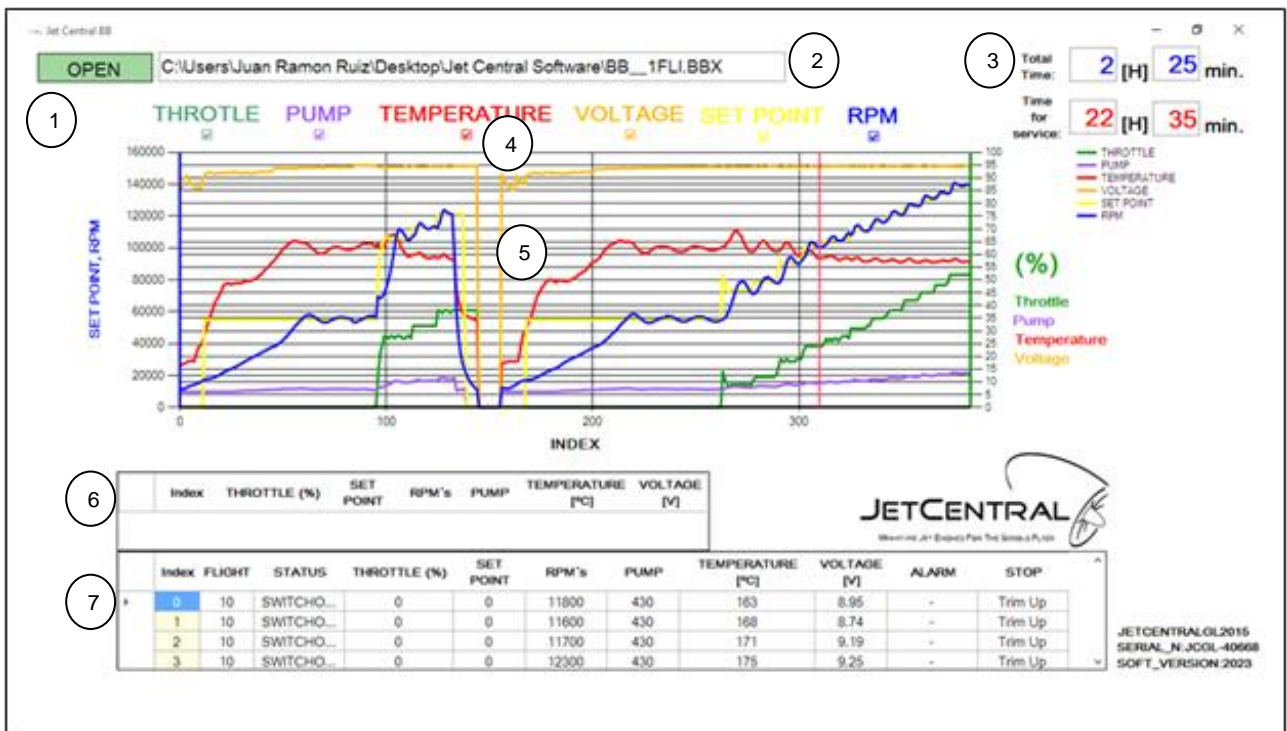

12.2 Using the application

After launching the application, click on the OPEN button in the upper left hand corner of the display window, a window is displayed to select the file you want to open. Double clicking on the file name or by selecting it with a mouse click and click on the Open button, the file data is read into the data table, flight times, service and graphics of the selected parameters will be displayed in the chart area.

Application Quick Guide

1. Open Button: This button navigates through the files from the computer or external memory, to select the file you want to open.
2. Address Bar: This will bar show the path where the selected file is located.
3. Timing: This section shows the flight time and time to service.

4. Activation menu graphics: In this menu, you can select the chart data to view (by default all active denoted by the check marks)
5. Graph area: This area displays the graphical form of the data.
6. Data Pointer: This table displays the numeric data which was selected in the graph area.
7. Data table: This table lists all data in numeric form.

12.3 Dynamic Graphics

In the graph you can zoom to see a compressed section of the data by double clicking the mouse pointer in area that you want to magnify. The graph variables can also be enabled or disabled by clicking the check box below each variable name.

In addition, if it is desired to perform analysis of a specific point this can be achieved by double clicking on the point and observe the data in the data table pointer located in the lower screen.

To return to the previous zoom click on the lower left corner of the chart area.

When the chart zoom window is active it can be moved along the entire graph with the scroll bar located at the bottom of the chart area.

13 Turbine Quick Start Guide

- Check fuel and electrical connections per drawing on page 14
- Adjust transmitter in the radio menu, (set fail safe)
- Prime Fuel and Kero Start lines until fuel reaches the turbine; this is done in the Test menu
- Check to see if batteries are fully charged and reset the amp. capacity in the Battery menu, Verify that the battery type and capacity are set up accordingly
- Check your altitude setting in the “World” menu
- Raise the trim and check that message changes to “Trim Up” in the main screen
- To initiate the start sequence move the throttle stick all the way up and down and wait until turbine is running.
- Wait at idle until a message “Min Pump Ok” appears
- Move the throttle stick slowly to full throttle and wait for a “Max. Pump Ok” message to appear
- Do some fast acceleration on the ground to see everything is working properly
- Shut down the turbine by lowering the throttle & trim

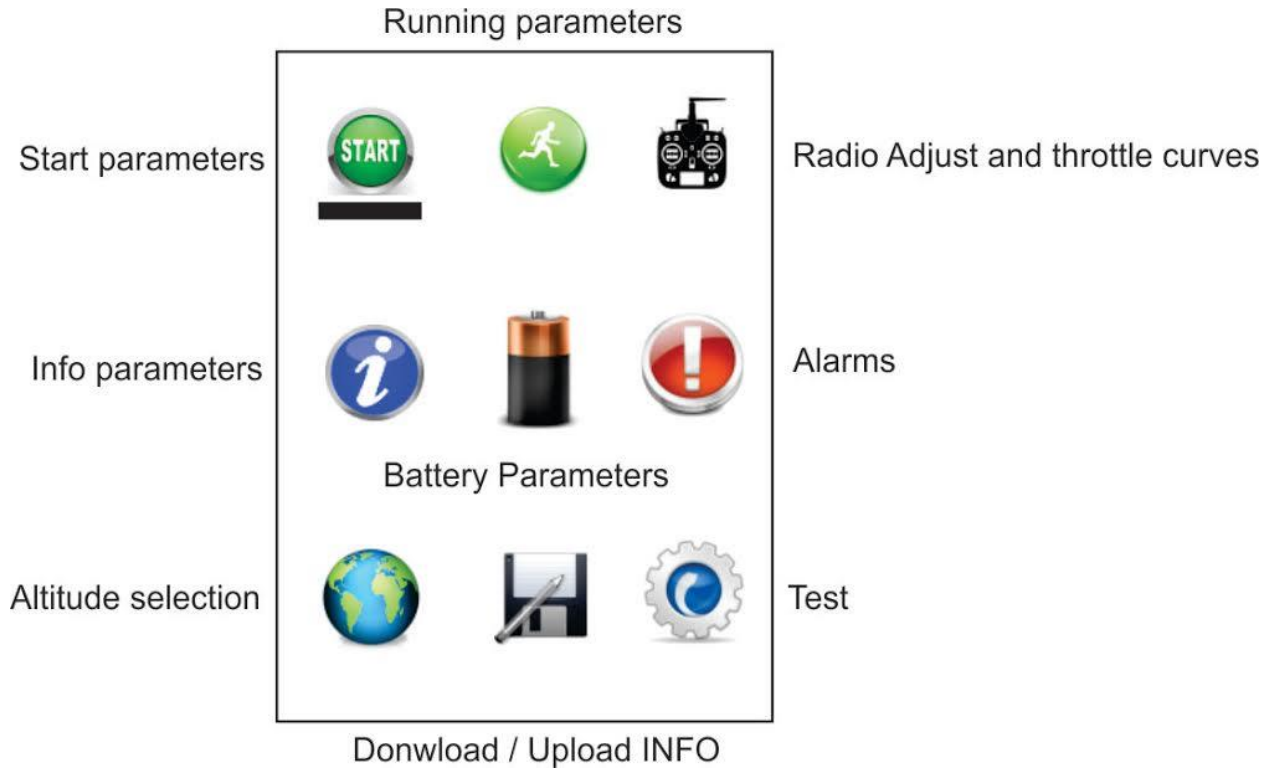

14 Safety Tips

- Remember to always have a fire extinguisher present during operations
- Caution a flooded turbine will lead to a hot start
- Inspect all turbine fuel connections and wiring periodically
- Safety wire all fuel connections
- Follow all instructions contained in this manual; take the time to learn all operations of the POWERPACK / ECU
- Under no circumstances charge your LiPo battery while installed in your aircraft
- Never operate the turbine indoors

Enjoy your new Jet Central Turbine. Your Jet Central Team welcomes you aboard and thanks you for selecting our product for your new turbine.

15 Lifetime Turbine Warranty

The Lifetime Limited Warranty coverage is provided on eligible turbines delivered to customers in all market areas. *Jet Central* will provide for repair or replacement of covered components of the turbine for life to the original owner in accordance with the following terms, conditions and limitations.

1. **Warranty Coverage.** Under the Limited Lifetime Warranty you are provided with coverage from the date of purchase (start date) provided you register your purchase with *Jet Central* within 15 days of purchase.
2. **Eligible Turbines.** 2006 model year turbines sold to eligible customers on or after October 1, 2006 in all market areas by *Jet Central* and/or its authorized dealers.
3. **Repairs Covered Under the Lifetime Limited Warranty.** *Jet Central* will repair, replace or adjust all covered components as specified on page 2 that fail due to defective material or workmanship or wear and tear resulting from defective material and workmanship during the applicable warranty period. Lifetime Warranty period is applicable to the original owner. Original owner must register their purchase with *Jet Central* within 15 days of purchase. There will be no exceptions to this rule.
4. **Component Protection.** Covers all components of the turbine with exception of battery.

Components of the turbine are limited to specifically those parts when combined and assembled result in a complete turbine engine.

5. **Where to Go for Covered Repairs.** *Jet Central* recommends that you return your turbine to *Jet Central Micro Turbine Manufacturing* or notify your dealer for instructions which will expedite the return and repair of your turbine. If you require assistance in receiving covered repairs or locating the nearest authorized dealer or for specific instructions for return, you may call *Jet Central* or email *Jet Central* direct. Please see operator's manual for contact information for your specific area.
6. **Repairs.** All warranty repairs of covered components MUST be made with service parts or manufactured parts authorized by *Jet Central*. In some cases, the use of *Jet Central* remanufactured parts is at the discretion of *Jet Central*.
7. **Care of Turbine.** Your turbine must be properly operated and maintained in accordance with the operation manual received with each turbine. Recommended maintenance schedules must be adhered to. It is your responsibility to make sure that all scheduled maintenance is performed and materials used meet *Jet Centrals* specifications. Failure to have scheduled maintenance performed as specified in the operators manual by *Jet Central* will invalidate warranty coverage on parts affected by the lack of proper operation and maintenance. Turbine **must** be operated with a FOD screen.
8. **Transferability.** This warranty is transferable. If you sell your turbine, *Jet Centrals* Limited Lifetime Warranty may be transferred to the new owner.

New owner is required to pay a transfer fee of \$250.00 USD, register his name as the new customer who owns serial number _____ within 15 days of purchasing a pre-owned *Jet Central* Micro Turbine sold on or after October 1, 2006 to its original owner. No exceptions will be available.

16 Worldwide Network

AMERICAS		
<p>MÉXICO SERVICE + DEALER Jet Central Factory Juan Ramón Ruiz Coltongo 158 CP 2630 México DF +(55) 50 90 74 77 www.jetcentral.com.mx</p>	<p>CHILE Jets RC Michel Durand +(2) 337 1203 +(9) 8361 6866 www.jetsrc.com sales@jetsrc.com</p>	<p>BRAZIL SERVICE + DEALER Jet model Michel Gonchorovski Carlos Eduardo Nichelle 1382, Centro. Foz Riogrande- Paraná CEP 83833-054 55 (0xx41) 3604 1155 www.jetmodel.com.br info@jetmodel.com.br Skype: MICHEL-ENGE</p>
NORTH AMERICA		
<p>USA JET CENTRAL AMERICAS Jose Melendez 231 Anthony Ave. SE Palm Bay, Florida 32909 321-412-3078 rcjets12@hotmail.com</p>	<p>USA EliteAerosports, INC Pablo Fernandez Scott Marr 732 NW 173RD TER, Pembroke Pines, FL 33029 954-444-8809 www.eliteaerosports.com info@eliteaerosports.com</p>	<p>USA Nirlybuilt Models Nir Schweitzer 301-257-9888 Nir@Nirlybuilt.com</p>
<p>USA Dreamworks Dreamworks Model Products LLC 775 Fentress Blvd Daytona Beach, Florida 32114 386-852-4793 todd@dreamworksrc.com www.dreamworksrc.com</p>	<p>USA Hobby Hangar of Virginia Kwang Ko. 14014 Sullyfield Cir, Chantilly, VA 20151 (703) 631-8820 www.hobbyhangarva.com</p>	<p>USA Kane Air Inc. Andy Kane + 301-785 3022 www.andykane.com</p>
		<p>CANADA Jet North Jets Doug Boyle 705-768-8355 jetnorthjets@gmail.com www.jetnorthjets.com</p>
EUROPE		
<p>ENGLAND SERVICE + DEALER Turbine Solutions Paul Hardman 16 Shepherd Lane Thurnscoe Rotherham South Yorkshire United Kingdom www.turbinesolutions.co.uk Sales@turbinesolutions.co.uk</p>	<p>SPAIN</p>	<p>GERMANY Jetcom E.K. Stefan Theophil Robert Bosch strasse 24 D-68766 Hockenheim +(49) 0 173 8833 650 +(49) 0 6205 2890 456 +(49) 0 6205 2890 455 www.jetcom-modellbau.de Stefan.theophil@jetcommmodellbau.de</p>
ASIA		MIDEAST
<p>TAIWAN Jinyi Technology Corp,LTD Dino Ou Chang-Shen 2F # 54 Shuang Feng Ed. Hsien-Chuang City, Taipei +(886) 911 35 3718 sy3660@ms21.hinet.ne</p>	<p>JAPAN Jetset Mashashi Tahara 2-1-26 Tonotuji Sumuyosiku, Osaka City 5580042 06 6675 0100 06 6675 0104 www.jetsetj.com info@jetsetj.com</p>	<p>QATAR AND EMIRATES Jet Central Middle East Rodrigo Flota jetcentralmiddleeast@gmail.com</p>

Please take note of different time zones, as **JET CENTRAL** is a worldwide company.

Appendix A: Thrust Graph

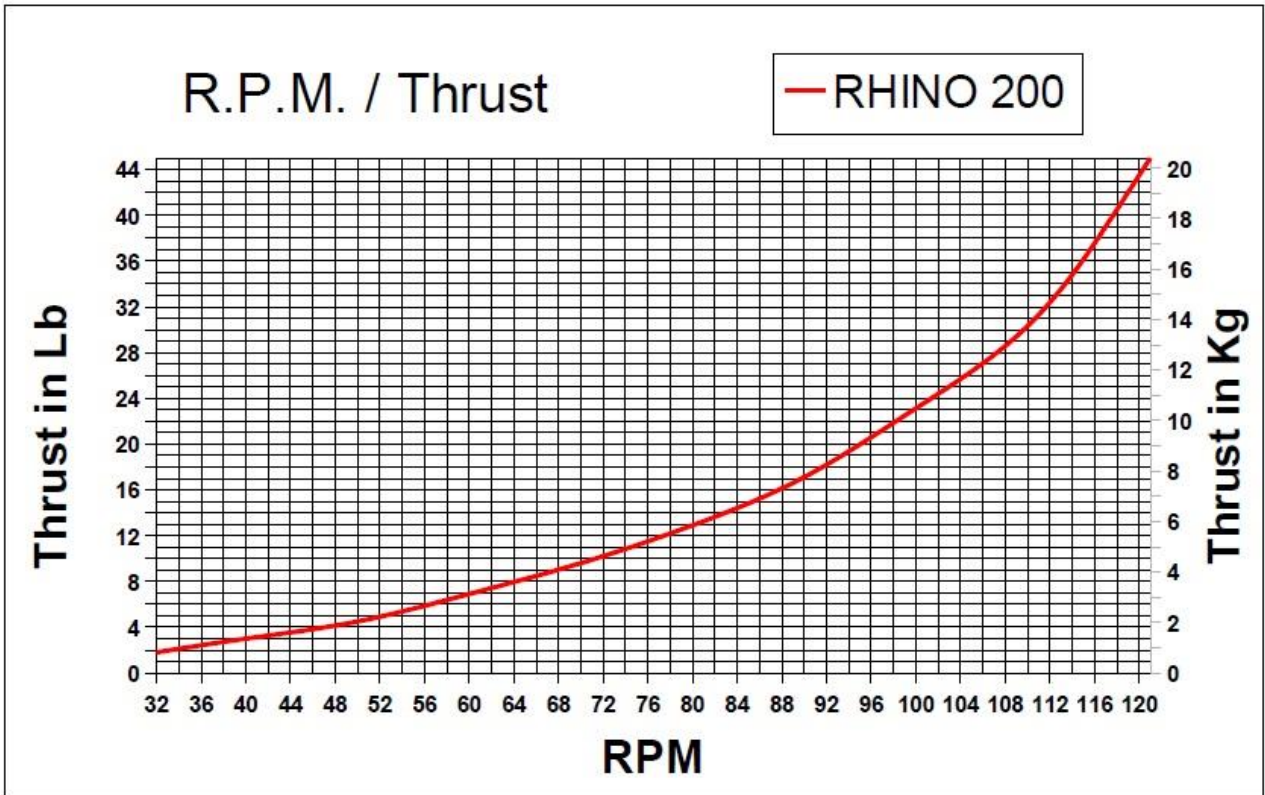

Appendix B: Mounting Dimensions¹

Jet Central Rhino 200
Mounting Dimensions 1:1 Scale
Dim's in millimeters

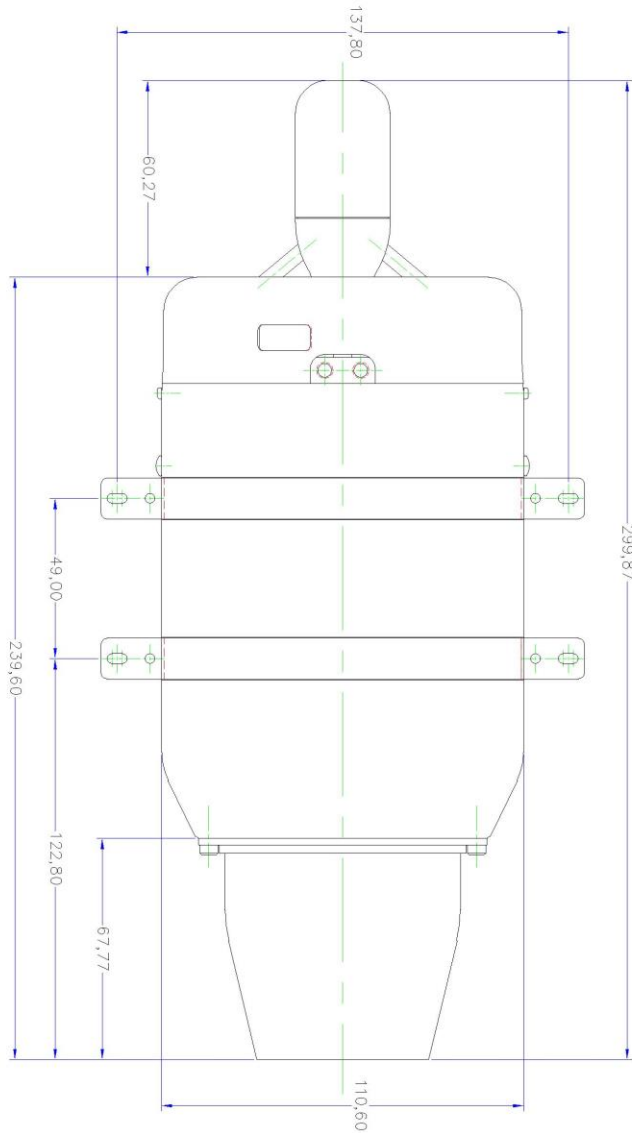

¹ This drawing is not fit to scale. Please check the website for a PDF that prints at scale.

Appendix C: Pipe Gaps

There are many factors affecting the best distance between the pipe and the turbine, like inlets and bypasses etc. so please refer to the airplane manufacturer and use this table just as reference

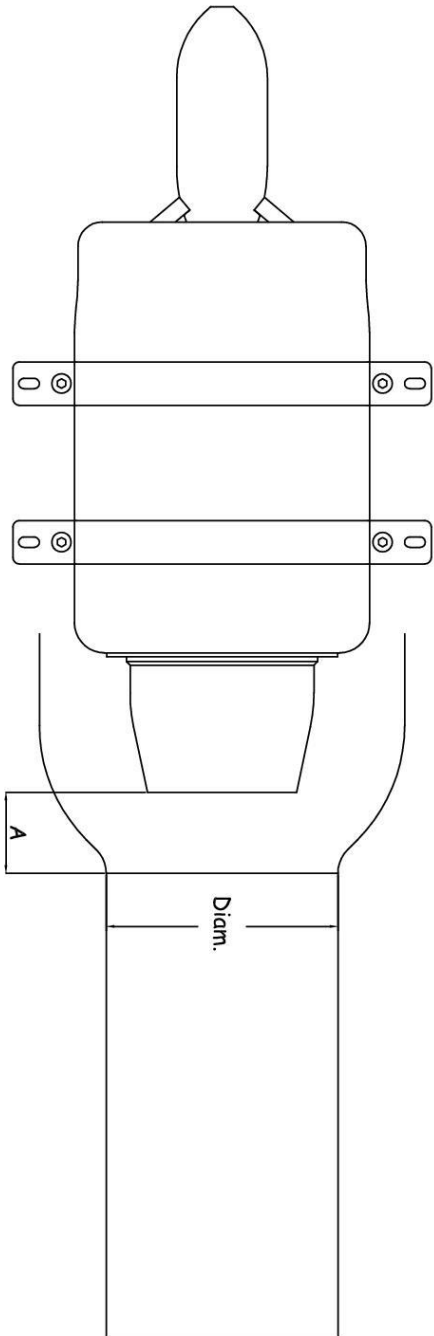

Some Notes:

The bigger the diameter of the pipe, the smaller the distance "A" you have to set

It is worse to be too close to the pipe than too far away

You can use a bigger pipe diameter than recommended but never smaller

Maintain the turbine and pipe always aligned and centered

	A max.	A min.	Diam. max.	Diam min.
Turbine				
Bee	22 mm	12 mm	70 mm	55 mm
Rabbit	25 mm	15 mm	75 mm	60 mm
Cheetah	30 mm	20 mm	80 mm	70 mm
Rhino	32 mm	22 mm	90 mm	80 mm
Mammoth	40 mm	30 mm	120 mm	100 mm

Turbine Accessories

Telemetry;

Telemetry interface for most popular transmitter brands

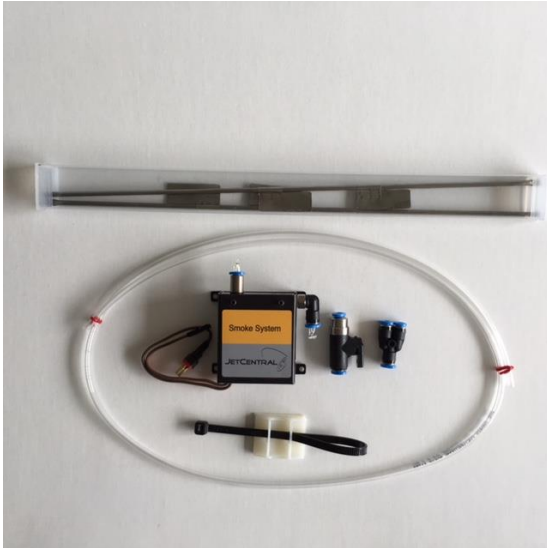
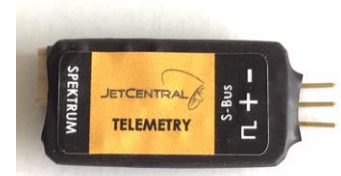

Smoke System

Variable flow smoke system with integrated pump and solenoid valve

On board Data Terminal

Small and lightweight, low battery consumption, auto shut off function

