

# HARDWARE IDENTIFIER

Illustrations on this page are to scale for faster identification of hardware during assembly.

**DO NOT RETURN PRODUCT IF YOU ARE MISSING PARTS.**  
Please Call: 1 (877) 728-8224

20

Washer: Flat  
5/16" (x6)  
**45M1111P**

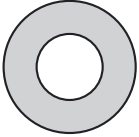

21

Washer: Flat  
1/2" (x4)  
**1019756**

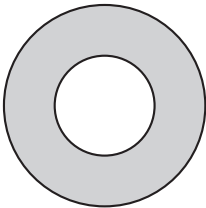

23

Spring (x1)  
**B-3805**

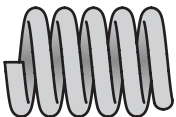

18

Nut: Hex  
1/2" (x2)  
**30M1600P**

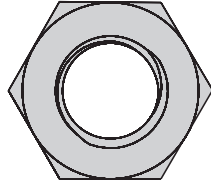

19

Nut: Nylock  
1/2" (x2)  
**B-5096Y**

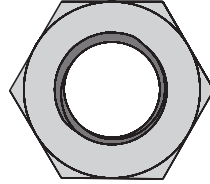

25

Nut: Nylock  
1/4" (x1)  
**B-4785**



26

Nut: Nylock  
5/16" (x12)  
**B-4786**

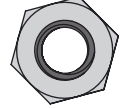

27

Hairpin Cotter (x1) .....  
**1019151**

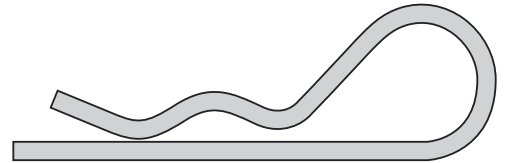

12

Bolt: Hex Head, 5/16 x 2 1/4" (x1) .....  
**2M1036P-FT**

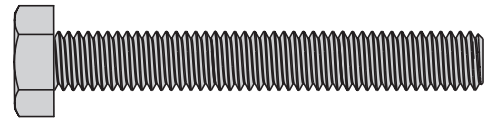

13

Bolt: Carriage, 5/16 x 2" (x2) .....  
**10M1032P**

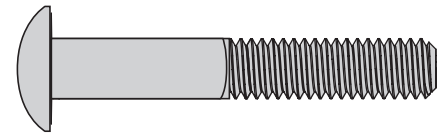

14

Bolt; Carriage, 1/4 x 1-1/2" (x1) .....  
**11M0824P**

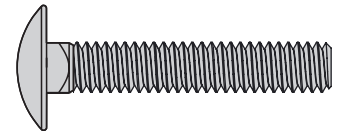

15

Bolt; Hex Head,  
1/2" x 3" (x2) .....  
**1M1648P**

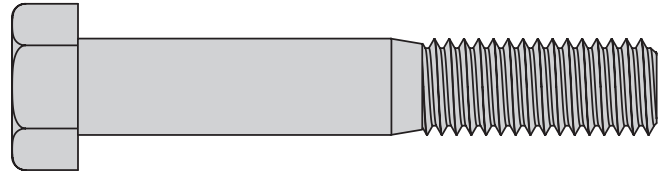

16

Bolt; Hex Head, 5/16 x 1" (x8) .....  
**2M1016P**

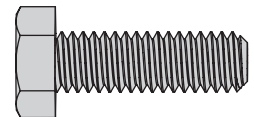

24

Drawbar Pin: 1/2" x 2 1/2" (x1) .....  
**B-3861**



# COMPONENT VIEW AND REFERENCE LIST

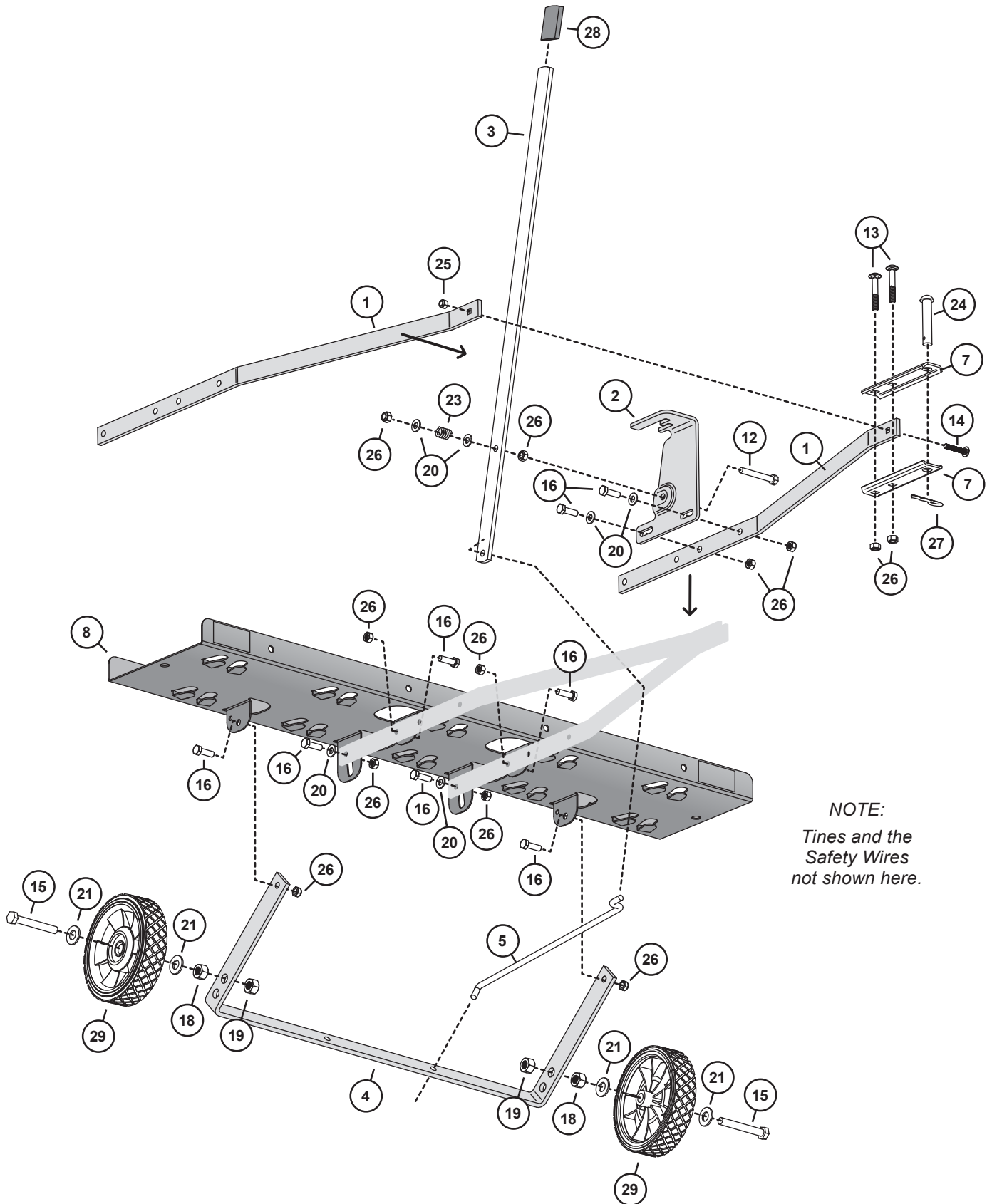

**NOTE:**  
 Tines and the  
 Safety Wires  
 not shown here.

# COMPONENT VIEW AND REFERENCE LIST

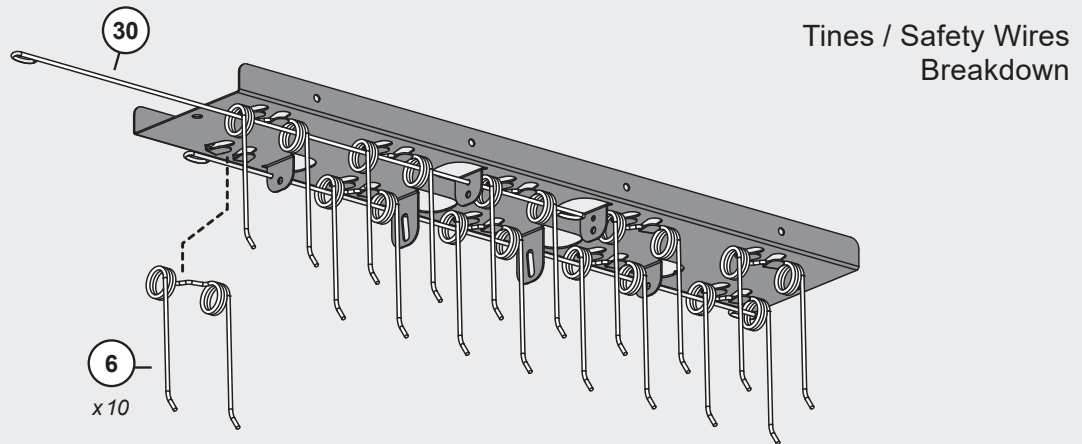

**DT2-40BH1-G**

**HARDWARE PACK** - Used during assembly:

Ref #	Part #	Description	Qty
1	1019212-16	Towbar	2
2	1019213-16	Lift Lock	1
3	1019209-16	Handle	1
4	1019214-16	Wheel Bracket	1
5	1008557	Control Rod	1
6	R-616	Tine	10
7	R-892-16	Clevis	2
8	1019418	Tray; with Labels	1
29	1008587	Wheel, 6" x 1.5"	2
30	R-1503	Safety Wire, 40"	2

1019104		SKIN PACK	1
12	2M1036P-FT	Bolt; Hex Hd., 5/16" x 2-1/4"	1
13	10M1032P	Bolt; Carriage, 5/16" x 2"	2
14	11M0824P	Bolt; Carriage, 1/4" x 1-1/2"	1
15	1M1648P	Bolt; Hex Hd., 1/2" x 3"	2
16	2M1016P	Bolt; Hex Hd., 5/16" x 1"	8
18	30M1600P	Nut, 1/2"	2
19	B-5096Y	Nut; Nylock, 1/2"	2
20	45M1111P	Washer; Flat, 5/16"	6
21	1019756	Washer; Flat, 1/2"	4
23	B-3805	Spring	1
24	B-3861	Hitch Pin, 1/2" x 2-1/2"	1
25	B-4785	Nut; Nylock, 1/4"	1
26	B-4786	Nut; Nylock, 5/16"	12
27	1019151	Hairpin; Cotter, 1/8"	1
28	1019103	Vinyl Grip	1



**INSTALLATION QUESTIONS? MISSING PARTS? NEED REPLACEMENT PARTS?**

**DON'T GO BACK TO THE STORE!**

Please call Customer Service Department Toll Free 877-728-8224 **OR** Email: [customerservice@brinly.com](mailto:customerservice@brinly.com)