



MODEL 3832C, 3834C

Vertical Drawer Adjustment Cam
32 mm System Box Drawer Slide
Up To 100 lb. [45.5] Capacity•

APPLICATIONS: For use in wood pedestals, dresser and desk drawers, casework, residential and kitchen cabinetry. *Not intended for lateral file drawer applications.† Use for side mount only. This product is covered by U.S. (5,980,007), (488,712) and various foreign patents issued and/or pending.*

3832C, 3834C QUICK REFERENCE

Side Space: (.50" + 0.031) x 2
Length: 3832C-6"-28"
3834C-12"-28"
Height: 1.80"
Load: 3832C-100 lbs. •
3834C-90 lbs. •

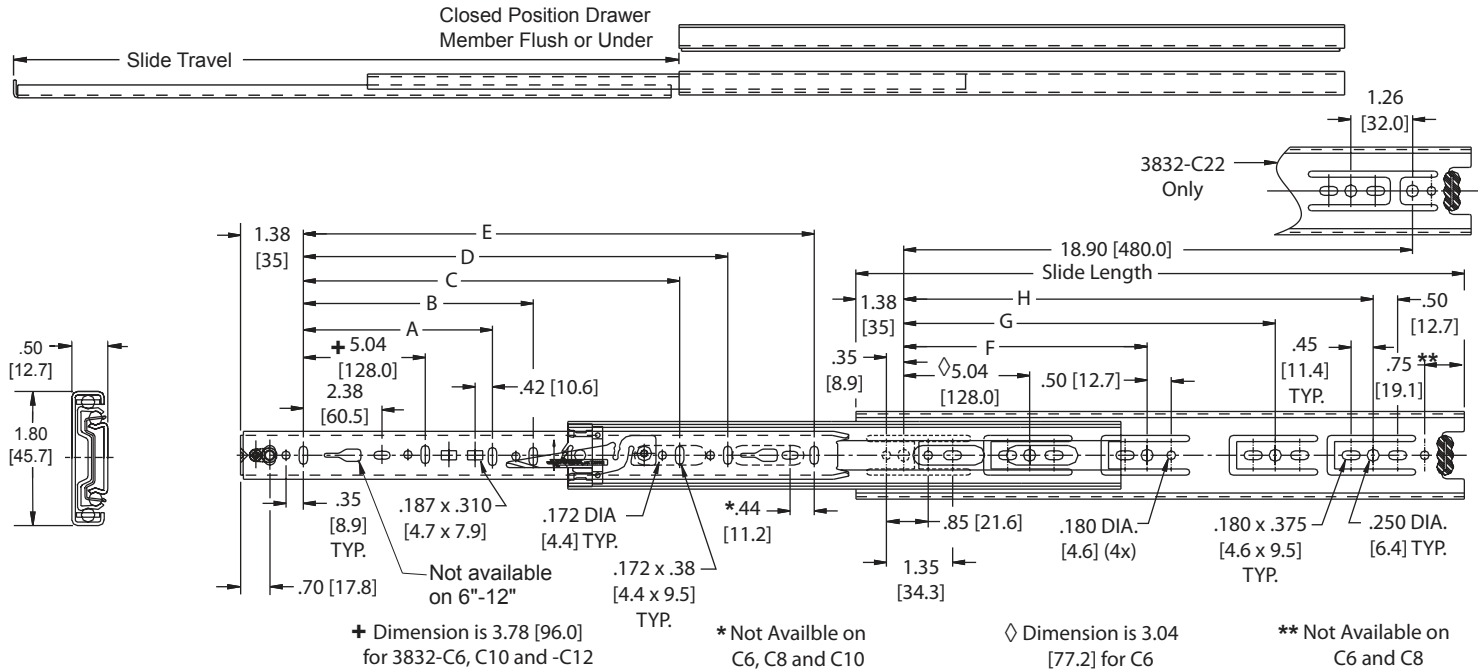

Finish	3832C: Bright electro-zinc (C), black zinc (CB), white electrocoating (EW), H-coat (CH) 3832 only ■ 3834C: Bright electro-zinc (C), black zinc (CB) ■
Length	3832C: 6"-28" [140 mm-700 mm] 3834C: 12"-28" [300 mm-700 mm]
Travel	3832C: Full extension 3834C: 1" Over travel
Height	1.80" [45.7 mm]
Load	3832C: 100 lbs. [45.5kg.] • 3834C: 90 lbs. [41.0 kg.] •
Side Space	.50" +0.031 / -0.0 [12.7 mm +.8 / -0.0]
Disconnect	Front, handed lever
Mounting	Side, optional face frame brackets
Hardware	Flat head 6 mm Euro System screw or #8 pan head screw, stainless steel screws for (CH) finish only.
Ball Bearings	C & CB finish: Steel EW finish: Acetal polymer in drawer member CH finish: Stainless steel
Features	Drawer member vertical adjustment cam, hold-in detent; silenced open and closed; 32 mm spacing on cabinet member holes
Optional Weather Resistant Finish (CH) 3832 only	Electro-zinc plating with H-coat overcoat provides 8 times more protection for installations subjected to indirect weather conditions. Includes stainless steel ball retainer and rivets.

Part Number	Slide Length	Slide Travel 3832	Slide Travel 3834	A	B	C	D	E	F	G	H
3832-C6	5.84 [148]	5.50 [140]									
3832-C8	7.84 [199]	8.00 [203]						5.56 [141]			
3832-C10	9.84 [250]	9.57 [243]						7.56 [192]			
3832-C12	11.81 [300]	12.00 [305]	13.00 [330]					9.52 [242]	8.82 [224]		
3832-C14	13.78 [350]	14.00 [356]	15.00 [381]					11.50 [292]	8.82 [224]		
3832-C16	15.75 [400]	16.00 [406]	17.00 [432]					13.47 [342]	8.82 [224]	12.60 [320]	
3832-C18	17.72 [450]	18.00 [457]	19.00 [483]			12.60 [320]		15.43 [392]	8.82 [224]	13.86 [352]	
3832-C20	19.69 [500]	20.00 [508]	21.00 [533]			12.60 [320]		17.40 [442]	8.82 [224]	16.38 [416]	
3832-C22	21.65 [550]	22.00 [559]	23.00 [584]			▲12.60 [320]	16.38 [416]	19.37 [492]	8.82 [224]	13.86 [352]	17.64 [448]
3832-C24	23.62 [600]	24.00 [610]	25.00 [635]	8.82 [224]		16.38 [416]		21.34 [542]	8.82 [224]	13.86 [352]	18.90 [480]
3832-C26	25.59 [650]	26.00 [660]	27.00 [686]	8.82 [224]		16.38 [416]	21.42 [544]	23.31 [592]	8.82 [224]	13.86 [352]	21.42 [544]
3832-C28	27.56 [700]	28.00 [711]	29.00 [737]	8.82 [224]	11.34 [288]	16.38 [416]	21.42 [544]	25.28 [642]	8.82 [224]	13.86 [352]	21.42 [544]

- ‡ A lateral file drawer is wider than it is deep
- ▲ Not available on 3834-22
- Load rating based on 18" slides mounted in a 16" wide drawer cycled 50,000 times.
- Clear and white finishes are RoHS compliant.

Installation Instructions

Install Cabinet Member

1. Separate slide members by lifting up the left hand disconnect lever and pushing down the right hand lever.
2. Install cabinet (large) member first. For applications with an overlay drawer front, refer to Figure 1 for conventional mounting and Figure 2 for 32 mm system mounting. For applications with an inset drawer front, set the slide back the thickness of the drawer front plus 1/8" [3.2 mm].

Install Drawer Member

3. Install the drawer member with a screw through the cam adjuster and through a hole or slot at the rear.

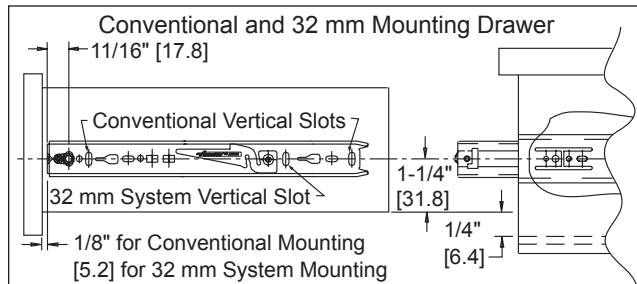
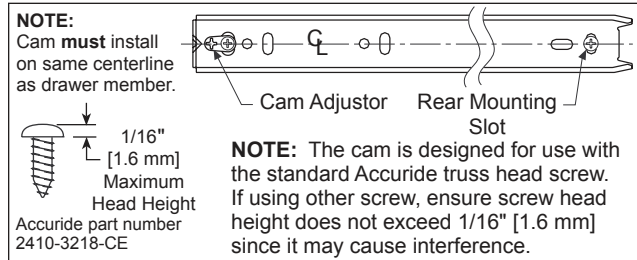

4. Make sure the ball bearing retainers in the cabinet side are fully forward. Install drawer into cabinet. Close the drawer.
5. Open the drawer and rotate the cam with a Phillips or Pozi screwdriver to vertically position the drawer in relation to the cabinet.

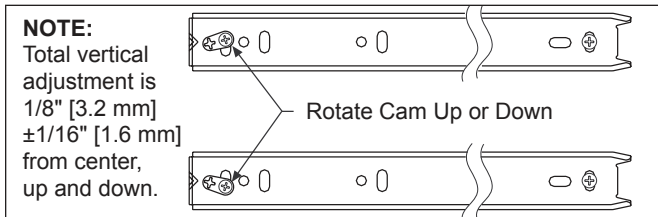

6. Install additional set screws to secure.

NOTE: Install drawer pulls or knobs after set screws are in place.

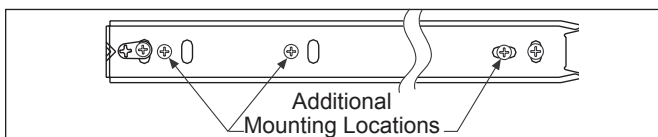

Slide ordering Instructions

Complete your slide order for Accuride models 3832C or 3834C by specifying the following:

10 Pair C 3832 -C18 D

Total Required Slides _____

Slide Finish _____

Slide Model _____

Slide Length _____

Polybag Packaging _____

For the most current technical information please visit www.accuride.com

Figure 1 Conventional Mounting—Cabinet

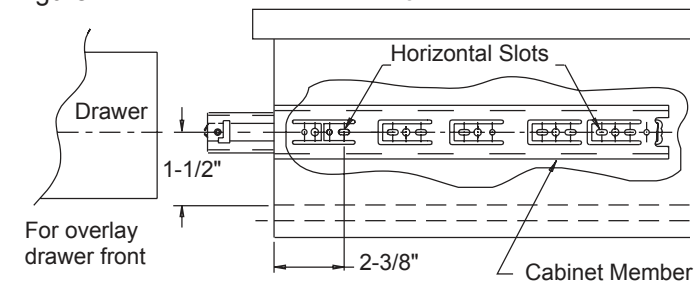
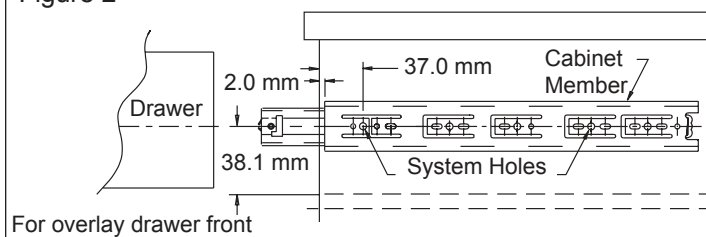

Figure 2 32 mm System—Cabinet



Optional Face Frame Brackets

Face frame brackets are ordered as a kit or in bulk. Brackets are available in clear zinc finish only. Mounting screws are not included.

To order **kits**, specify part number 4180-0322-XE. Each kit contains: 2 front brackets, 2 rear brackets, and installation instructions. Order 1 kit per pair of slides.

For **bulk**, order 2 front brackets (P/N 4010-0516-CE) and 2 rear brackets (P/N 4080-0508-CE) per pair of slides.

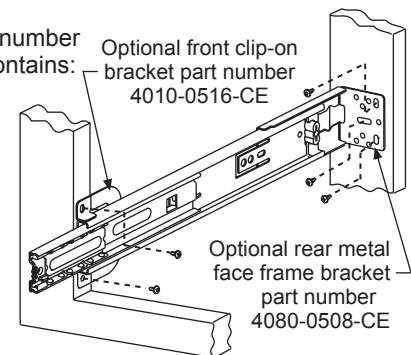

Packaging Options

Models 3832C, 3834C available in D-pack or bulk packaging. Model CH3832 available in D-pack only.

Distributor (D) Pack: All lengths are packaged 10 pair per box. Polybag includes one pair of slides with mounting screws.

Bulk (P) Pack: All lengths are packaged 10 pair per box. Slides and screws are ordered and packaged separately.

Specifications

Slide members and ball retainers: Cold rolled steel
Ball bearings: Carburized steel/acetal polymer
Clear and white finishes are RoHS compliant.

NOTE: Specifications, materials, prices, terms, and delivery are subject to change without notice.

Accuride

ACCURIDE INTERNATIONAL INC.

12311 Shoemaker Avenue
Santa Fe Springs, CA 90670

TEL (562) 903-0200
FAX (562) 903-0208
www.accuride.com

Manufacturing, Engineering, and Sales
United States • Germany • Japan • Mexico • United Kingdom • China

Copyright © 2007 Accuride International Inc. 3700-9464(1107)-MK097-R7-0608