



# FUSION™

## TACTICAL



WE BUILD BEYOND  
[www.FusionTacticalUSA.com](http://www.FusionTacticalUSA.com)



INDEX



FUSION™

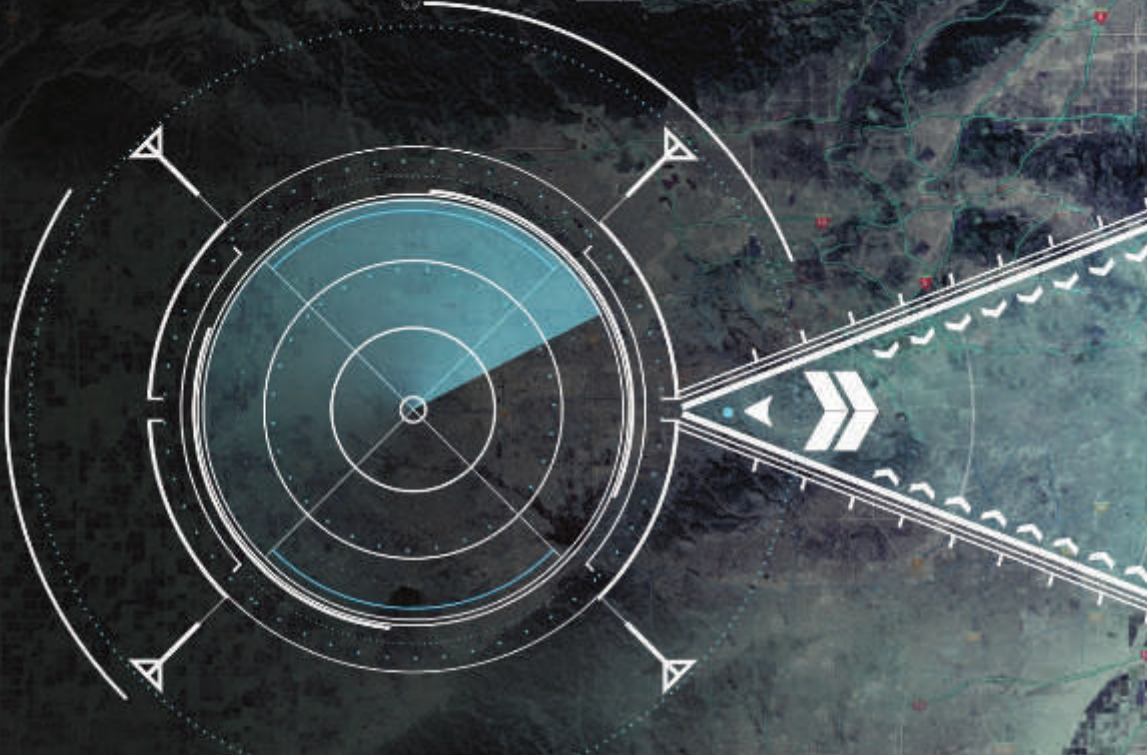

## ABOUT US

Since 1998, FUSION has designed and manufactured a diverse range of industrial, safety, and sporting products used in the construction, climbing, zip-lining, rigging, arborist, and commercial OEM industries. In 2015, FUSION began to expand its reach and expertise to create purposeful gear used in the law enforcement and military sectors. For over 18 years, our customers have relied on FUSION for custom-sewn industrial products that meet their precise specifications, production needs, quality standards, and logistical requirements. Our in-house design and engineering team assists customers with every step of the creative process, beginning with research and development using the latest technologies in design and 3D modelling and ending with a refined, innovative, market-ready product. We are constantly improving our existing lines to create new products that not only meet but exceed safety standards (UIAA, CE, ANSI, ASTM). FUSION's military inspired gear is durable, strong, and adheres to stringent MIL-SPEC standards, yet is affordable and practical for everyday civilian use.

## MISSION STATEMENT

FUSION is passionate about providing the highest level of integrity, quality, customer service, and value to all customers. We only manufacture products that we stand behind and would use ourselves. FUSION strives and dedicates our energy to continuous improvement toward satisfaction, professional knowledge, promptness, friendliness, respect, and mutual success.

Furthermore, we base our success largely on the respect and satisfaction garnered from our customers as well as the pride and cheerfulness of all our employees. Here at FUSION, we aim to guide, train, safeguard, and provide a pleasant work environment for everyone under the FUSION brand. We treat them with the care, respect, and dignity they deserve while expecting them to pass the same standards onto our own valued customers.

MANUFACTURING PROCESS	06-07	CARABINERS AND GEAR	58-59
TACTICAL HARNESES	08-33	HARDWARE & WEBBING	60-61
TACTICAL LANYARDS	34-37	K9 TREKKER COLLAR	62-63
TACTICAL BELTS	38-51	K9 HARNESS	64-65
BELT KEEPERS	52	K9 LEASHES	66-69
LEG HOLSTER STRAP	53	FUSION BAGS	70-71
GUN SLINGS	54-55	BELT OPTIONS CHART	72-73
BUCKLE OPTIONS	56-57	LANYARD OPTIONS CHART	74-75
		DECLARATIONS PAGE	76

# MANUFACTURING PROCESS

In-house concept design and prototyping

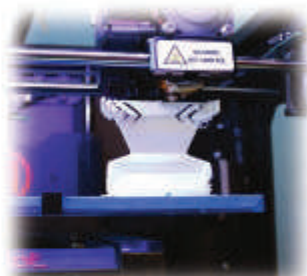
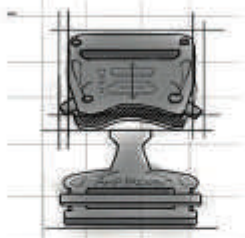

Material procurement



## PRODUCTION

Apply binding



Manual stitching



Attention to detail



Heat treatment



# PROCESS

## Prefabrication



## CTION



## Automated stitching for key joints



## Quality Control



MADE IN THE U.S.A. →

# HARNESSES

## FULL BODY HARNESSES



- 4,000 lb rated Presto™ quick-release steel waist and leg buckles
- 3D EVA Foam waist padding
- Foam-padded shoulders, waist, and legs
- Aluminum D-rings on side/back/front

- Two gear loops, one steel Delta quick-link
- Durable 7,000 lb rated nylon webbing
- MBS: 25kN
- Adult Sizes: S, M/L, L/XL

## HALF BODY HARNESSES

TCH-603-3D/TCH-603-FLAT



This harness comes fully equipped with six points of connection as well as an aluminum D-ring on the back allowing for free movement and pivoting while in a suspended position. The contour of this harness follows wherever the user's weight is placed throughout the harness. Featuring foam-padded shoulders and waist. One steel Delta quick-link on the waist and two gear loops on the back. Webbing is rated at 7,000 lb. Available in Black and Coyote Brown.

Flat foam waist padding

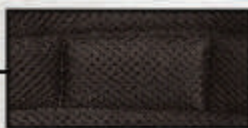

**TAC-RESCUE**  
TCH-603-FLAT

2 Gear loops

FP-2139-3 steel adjustable buckles

- 4,000 lb rated Presto™ quick-release steel waist and leg buckles
- Flat foam waist padding
- Foam-padded shoulders, waist, and legs
- Aluminum D-rings on Side/Back/Front

- Two gear loops
- One steel Delta quick-link
- Durable 7,000 lb rated nylon webbing
- MBS: 25kN
- Adult Sizes: S, M/L, L/XL

## FULL BODY HARNESSSES

TCH-603-2-ST



This harness comes fully equipped with foam padding and six points of connection. The steel D-rings on the back allow for free movement and pivoting while in a suspended position. The contour of this harness follows wherever the user's weight is placed throughout it. One steel Delta quick-link, two D-rings on the waist and two gear loops on the back. Webbing rated at 7,000 lb. Available in Black and Coyote Brown.



- Padded waist, shoulders, and legs
- Steel D-rings on side/back/front
- Durable 7,000 lb rated nylon webbing

- Two gear loops
- Steel Delta quick-link
- MBS: 25kN
- Adult Sizes: S, M/L, L/XL



## FULL BODY HARNESSSES

TCH-605



This Y-shaped harness comes fully equipped with 3D EVA Foam pads and six points of connection. The D-ring on the back allows for free movement and pivoting while in a suspended position. The contour of this harness follows wherever the user's weight is placed throughout it. A steel O-ring on the rear securely holds the harness together and back straps feature High-Vis strips, making the user easier to spot in dim-light situations. Single Raptor™ quick-release aluminum buckle and steel Delta quick-link on chest. Two gear loops on the back. Webbing rated at 7,000 lb. Available in Black and Coyote Brown.



- 4,000 lb rated Raptor™ quick-release aluminum waist and inner leg buckles
- 3D EVA Foam padded waist and shoulders
- Aluminum D-rings on side/back/front

- Durable 7,000 lb rated nylon webbing
- Two gear loops, One steel Delta quick-link
- Back O-ring & High-Vis strips
- Adult Sizes: S, M/L, L/XL

## FULL BODY HARNESSSES

TCH-501



This TAC-SCAPE H-Style Harness is a heavy duty, full body harness featuring Presto™ quick-release steel buckles on the chest, waist, and legs for easy on/off. Aluminum light-weight D-rings are included on the side, back, and front of the harness. The waist, shoulders, and legs all feature inner 3D EVA Foam padding for comfort during long hours of wear. Constructed from 7,000 lb rated MIL-SPEC type 13 webbing and includes comfortably padded shoulders and waist. It has five points of connection.



- 4,000 lb rated Presto™ quick-release steel chest, waist, and inner leg buckles
- Fast-pass FP-2139-3 steel adjustable buckles
- Foam-padded shoulders and waist

- Aluminum D-rings on side/back/front
- Durable 7,000 lb rated nylon webbing
- MBS: 25kN
- Adult Sizes: M-XL

## FULL BODY HARNESSSES

TCH-501-2



This H-Style Harness is a heavy-duty full body harness featuring Raptor™ quick-release aluminum buckles on chest, waist, and legs for easy on/off. Aluminum, light-weight D-rings are included on the side, back, and front of the harness. Constructed from 7,000 lb rated MIL-SPEC Type 13 webbing and includes multiple fast-pass steel adjustable buckles for safe and quick adjustments. Features foam padding on shoulders and waist.



- 4,000 lb rated Raptor™ quick-release aluminum waist and inner leg buckles
- Fast-pass FP-2139-3 steel adjustable buckles
- Foam-padded shoulders and waist

- Aluminum D-rings on side/back/front
- Durable 7,000 lb rated nylon webbing
- MBS: 25kN
- Adult Sizes: M-XL

## FULL BODY HARNESSSES

TCH-625



The FUSION TAC-SCAPE Lite Harness is a modified version of our original TAC-RESCUE Harness with a D-ring added for fall arrest. The D-ring on the back allows for free movement and pivoting while in a suspended position. The contour of this harness follows wherever the user's weight is placed throughout it. This harness comes fully equipped with 3D EVA Foam pads and multiple points of connection. It is constructed with low-profile padding at the lumbar/waist and no padding at the shoulders for increased adjustability. Webbing is rated at 7,000 lb. Available in Black and Coyote Brown.



- 4,000 lb rated Presto™ quick-release steel waist and inner leg buckles
- Padded waist and shoulders
- Aluminum D-rings on side/back/front

- Durable 7,000 lb rated nylon webbing
- MBS: 25kN
- Adult Sizes: S, M/L, L/XL

## HALF BODY HARNESSES

TCH-107-2106-3C

The CONCERTO Half Body Harness is constructed of high-strength MIL-SPEC webbing and features Presto™ quick-release steel buckles on waist and leg areas for safe and convenient on/off. This harness is simple to use and can be used for training purposes. Its dual-colored leg straps specify the left from the right, and it can be used as a rappelling harness. Featuring a single reinforced tie-in anchor point on the front of the 2" waist and is 5,000 lb rated webbing. Available in three colors: Black, Coyote Brown and Foliage Green.



Front tie-in anchor point



- Front tie-in anchor point
- 4,000 lb rated Presto™ quick-release steel waist/leg buckles
- 5,000 lb MIL-SPEC webbing with reinforced stitching

- Dual-colored leg straps
- MBS: 23kN
- Adult Sizes: M-XL

## HALF BODY HARNESSSES



Steel D-ring

4,000 lb rated Presto™ steel buckle



- Front D-ring point
- 4,000 lb rated Presto™ quick-release steel buckle on waist
- Adjustable FP-2137 steel buckles on legs

- 5,000 lb MIL-SPEC webbing with reinforced stitching
- Elastic rear leg straps
- MBS: 23kN
- Sizes: S/M, M/L, L/XL

## HALF BODY HARNESSSES

TCH-101-1-2105+2105



The APOLLO Harness is a basic rappel harness that is light-weight, padded, and equipped with fast-pass steel buckles used for the waist and leg adjustments. Stamped steel D-ring used as the front connection point. Featuring a supported waist with 5,000 lb rated webbing and additional rear leg straps for a more secure hold of the legs. The harness is comfortable and easy to put on. The APOLLO 2 (shown opposite) has all the same features as the APOLLO with the addition of the 4,000 rated Presto™ quick-release steel buckles for waist and leg adjustments.

Adjustable FP-2137 steel buckles



Elastic seat strap

- Front D-Ring point
- Adjustable FP-2137 steel buckles on waist and legs
- 5,000 lb MIL-SPEC webbing with reinforced stitching

- MBS: 23kN
- Sizes: S/M, M/L, L/XL

## HALF BODY HARNESSES

TCH-101-1-2139+2139



The TEKA Half Body Harness is a practical and very popular harness among users in the tactical community. Low-profile and light-weight, with a forged steel D-ring used as a front connection point. Packable for quick donning and doffing. 5,000 lb rated and available in Black or Coyote Brown.



- Front steel D-ring
- FP-2139-3 steel adjustable buckles on waist and legs
- 5,000 lb MIL-SPEC webbing with reinforced tie-in point and stitching

- Foam-padded waist
- MBS: 23kN
- Adult Sizes: S, M/L, L/XL



## HALF BODY HARNESSES

TCH-101-2-2139-ES



The TEKA half body harness is perfect for outdoor rappelling. Securing yourself is made easy with its three points of adjustment, elastic seat straps, and leg adjustment buckles. A primary steel D-ring and a backup steel D-ring are also conveniently located on the front and back of the harness with padded leg straps. Webbing is rated at 5,000 lb.



- Front reinforced tie-in D-ring
- Fast-pass adjustable steel buckles on waist and legs
- Padded leg straps

- 5,000 lb MIL-SPEC webbing with reinforced tie-in point and stitching
- MBS: 23kN
- Sizes: M-XL

## HALF BODY HARNESSSES

3D EVA Foam waist



**CENTAUR DELUXE**  
TCH-107-3D

Gear loops on waist



FP-2139-3 steel adjustable buckles

- 3D EVA Foam padding
- Front belay anchor point
- Fast-pass FP-2139-3 steel buckles on legs/waist
- Two gear loops on each side of the waist

- 5,000 lb MIL-SPEC webbing with reinforced stitching
- MBS: 23kN
- Adult Sizes: S, M/L, L/XL

## HALF BODY HARNESSSES

TCH-107-3D / TCH-107-FLAT



The CENTAUR Deluxe Half Body Harness is our padded version of the original Centaur Harness. This harness features 3D EVA (shown opposite) or flat foam padding on the waist. The legs are padded with flat foam and are secured with an elastic strap. This harness includes fast-pass steel buckles for easy on/off and quick adjustment. Gear loops are also available on these harnesses.



- Flat foam padding or 3D EVA foam
- Front belay anchor point
- Fast-pass FP-2139-3 steel buckles on legs and waist
- 5,000 lb MIL-SPEC webbing with reinforced stitching
- MBS: 23kN
- Adult Sizes: S, M/L, L/XL

## HALF BODY HARNESSSES

TCH-107-2139-3



The CENTAUR is our most popular and versatile harness that can be used for various applications from climbing and zip-lining to challenge courses or fast rappel works. This harness features a front, reinforced connection point with 5,000 lb rated webbing throughout the construction of the harness. All bar-tack stitching is also rated at 5,000 lb. Elastic leg straps are included for improved mobility for the user. 4,000 lb rated adjustable steel buckles are used for both waist and leg adjustment. The CENTAUR is multi-functional and cost-effective for high volume use, making it a true value-based harness. Available in Black or Orange webbing.

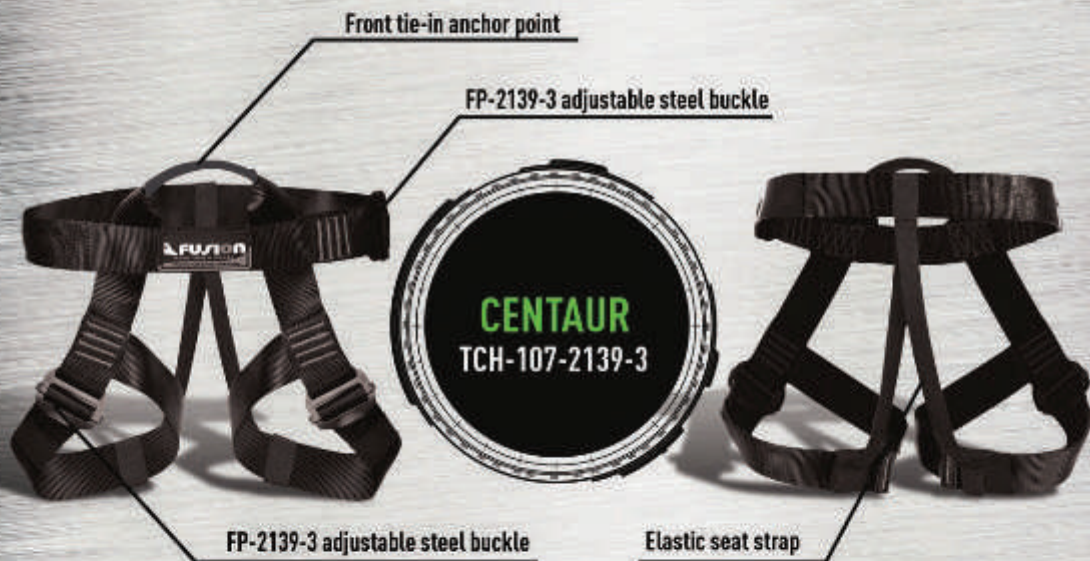

- Fast-pass FP-2139-3 steel adjustable buckles on waist and legs
- 5,000 lb MIL-SPEC stitching and webbing with reinforced tie-in point

- MBS: 23kN
- Adult Sizes: M-XL

## HALF BODY HARNESSSES

TCH-108



The MIRAJ Half Body Harness is the ideal tactical use harness, great for rappelling applications. In its design, is a wide leg strap that is constructed for a larger surface area for added comfort and support when doing long rappel exercises. This harness features a reinforced web front connection point with 5,000 lb rated webbing throughout the construction of the harness. All bar-tack stitching is 5,000 lb rated. Elastic leg straps are included for improved mobility for the user. This tactical harness also features the 4,000 lb rated Raptor™ quick-release aluminum buckle for both waist and leg adjustment.

Front tie-in point

5,000 lb MIL-SPEC webbing



4,000 lb rated aluminum Raptor™ buckle

- Front tie-in anchor point
- 4,000 lb rated Raptor™ quick-release aluminum waist/leg buckles

- 5,000 lb MIL-SPEC webbing with reinforced tie-in point and stitching
- MBS: 23kN
- Adult Sizes: M-XL

## HALF BODY HARNESSES

### SPARTACUS TCH-603-SEAT-3D

Aluminum D-ring

3D EVA Foam waist

Flat foam leg

4,000 lb rated Raptor™ aluminum buckle

- Front belay anchor point
- Raptor™ quick-release aluminum buckles on legs
- Fast-pass FP-2139-3 steel buckles on waist

- 5,000 lb MIL-SPEC webbing with reinforced stitching
- MBS: 23kN
- Adult Sizes: S, M/L, L/XL

## HALF BODY HARNESSSES

TCH-603-SEAT



The popular SPARTACUS TAC-Rescue Harness is a half body harness equipped with all the features of the full body version. Includes padded, high lumbar support, 3D EVA Foam with aluminum positioning D-ring and front connection point. EVA mesh leg pads are used for added comfort and moisture control. The leg straps are adjustable for optimizing comfort when in use for extended periods of time. Both leg straps use Raptor™ quick-release aluminum buckles for quick donning and doffing. Gear loops included for versatile use.

Flat foam waist



FP-2139-3 steel  
adjustable buckles



4,000 lb rated Raptor™ aluminum buckles

- Front belay anchor point
- Raptor™ quick-release aluminum buckles on legs
- Fast-pass FP-2139-3 steel buckles on waist

- 5,000 lb MIL-SPEC webbing with reinforced stitching
- MBS: 23kN
- Adult Sizes: S, M/L, L/XL

**GRIFFIN**  
RH-1211

Inside-front velcro pouch



- Three colors to choose from: Black, Coyote Brown, and Foliage Green
- Inside-front velcro pouch
- Three Raptor™ quick-release aluminum buckles rated 18kN

- 5,000 lb rated webbing
- Adult Sizes: M-XL



## RESCUE HARNESSES

RH-1211

The GRIFFIN is the pouch version the popular MIRAJ with all the same specs including a built-in, heavy duty 800D nylon pouch to store the harness when not in use. Just a quick pull on the pouch and the harness drops down - ready for use. This harness could be put on in as fast as 10 seconds with practice. The GRIFFIN features a reinforced web front connection point with 5,000 lb rated webbing throughout the construction of the harness. In the GRIFFIN's engineering, there is a wide leg strap creating a larger surface area for added comfort and support when doing long rappel exercises. All bar tack stitching is 5,000 lb rated. This tactical harness also features the Raptor™ quick-release aluminum buckles with a 4,000 lb rating for both waist and leg adjustment.



Inside-front Velcro pouch



4,000 lb rated quick-release aluminum buckle

- Three colors to choose from: Black, Coyote Brown, and Foliage Green
- Inside-front Velcro pouch
- Three Raptor™ quick-release aluminum buckles rated 18kN

- 5,000 lb rated webbing
- Adult Sizes: M-XL

## RESCUE HARNESSES

RH-1211-21-3C



The ARTEMIS Harness is used for training for emergency and search/rescue situations. Wear it as a duty belt, then simply open the inside-front Velcro pouch, connect the leg loops to air evac or rappel in a heartbeat. Features three high-strength, Raptor™ quick-release aluminum buckles (18kN) on legs/waist. Colored leg straps easily indicate the direction of the harness with reinforced nylon straps and tie-in point for strength and durability. Webbing rated at 4,000 lb. Weight: 11lb, 8oz.

Inside-front Velcro pouch



4,000 lb rated Raptor™ quick-release aluminum buckles

- Inside-front Velcro pouch
- Raptor™ quick-release aluminum buckles
- 5,000 lb rated webbing

- Dual-colored leg straps
- Adult Sizes: M-XL

## CHEST HARNESSSES

CH-200



The STIKA Chest Harness is designed to be used with a seat harness for fast conversion to a full body harness when needed. The shoulder straps are adjustable with fast-pass steel adjustable buckles. Totally packable when not in use. The connection points are reinforced with additional tubular webbing for improved wear resistance.

FP-2139-3 steel adjustable buckles



- Fast-pass FP-2139-3 steel adjustable buckles
- 1.75" wide 5,000 lb rated polyester webbing with reinforced loops
- Polyurethane back plate

- MBS: 23kN
- Optional D-ring available on request
- Adult Sizes: M-XL

## CHEST HARNESSSES

CH-201



The TYCHE Chest Harness is designed for easy and fast donning in emergency situations; i.e. when the wearer has to have a harness on in seconds to be lifted out of a manhole or during helicopter rescue scenarios. Made of 5,000 lb rated webbing, all bar-tack stitching is 5,000 lb rated as well. Each connection point is reinforced with additional tubular webbing for improved wear resistance.



- Fast-pass FP-2139-3 steel adjustable buckles on shoulder/back
- 1.75" wide 5,000 lb rated polyester webbing with reinforced loops

- MBS: 23kN
- Adult Sizes: M-XL

## CHEST HARNESSSES

CH-603-SHD



This Y-style chest harness features 1.75" durable polyester material with reinforced stitching and comfortably padded shoulders and back. Front and back aluminum D-rings for multiple connection points and a front Presto™ quick-release steel buckle for easy on/off.

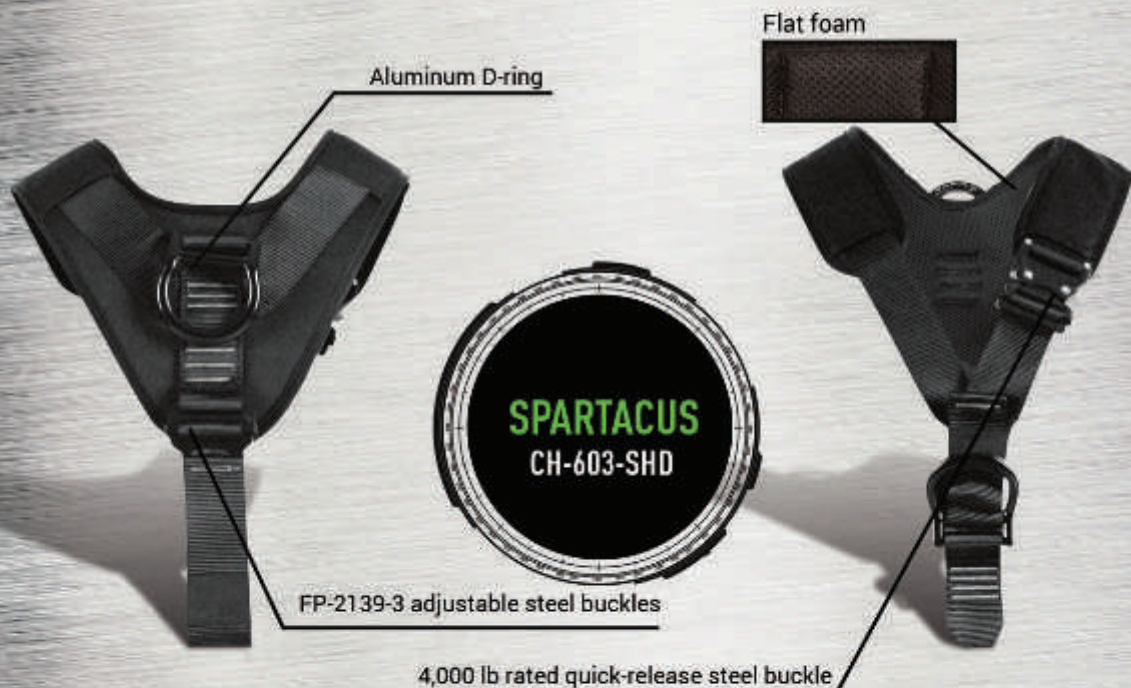

- Presto™ quick-release steel buckle
- 1.75" wide 5,000 lb rated polyester webbing with reinforced stitching
- Shoulder and back padding

- Two connection points: front and back aluminum D-rings
- MBS: 23kN
- Adult Sizes: M-XL

## CHEST HARNESSES

CH-500



The heavy-duty ARES Battle Harness System comes with a fully-removable shoulder unit and secured by Raptor™ quick-release aluminum buckles. The Battle Harness includes a high lumbar reinforcement pad of 3D EVA Foam foundation for support and cooling during long hours of use. MOLLE straps on both sides are for attachment of gear. A Shooters Belt snakes through the waist area and is constructed of 2", high strength, resin reinforced MIL-SPEC webbing for rigid construction. Tough and rugged in design with minimal weight and versatility for attachment of kit and loadout.



- Six Raptor™ quick-release aluminum buckles, rated 4,000 lb
- 5,000 lb rated webbing with reinforced stitching
- Two front accessory D-rings

- 3D EVA Foam padded shoulders/waist
- MBS: 23kN
- Adult Sizes: M-XL

# HARNES SIZING CHART

## MEASUREMENTS

	S	M	L	XL
CHEST	34-38"	38-42"	42-46"	46-52"
WAIST	24-28"	28-33"	33-38"	38-42"
LEG	18-20"	20-24"	24-28"	28-32"
HEIGHT	4'6"-5'	5'-5'6"	5'6"-6'	6'-6'6"





### FUSION Tactical HELO Retention Lanyard

The FUSION HELO Retention Lanyard is constructed for rescue use on helicopters and is available in standard extended lengths of 2, 3, and 4 ft. Custom lengths are available on request. Being a critical piece of gear, it's extended length allows the user to sit on remote positions. Stainless steel quick-release shackles are used and rated at 18 kN with a swaged pin and a welded ring to prevent accidental release. Opening of shackle diameter is 1/4", MIL SPEC rated tubular webbing is rated 4,000 lb, stitched with thread made of industrial grade nylon bonded T-131 for maximum strength of load bearing equipment.

The ends of the lanyards can include webbing loops, rubberized handle bars, or aluminum snaphooks or carabiners. Being a true California based manufacturer, we can customize products to fit your needs with a fast turnaround time. Please contact our knowledgeable sales representatives for more info.

**NOTE: \*\* Working Load: 5,000 lb (10:1); Compatible with FUSION CQB belt**



**LH-32-8001-2999-BK24**  
Single leg lanyard with FP-2999+ FP-8001

**2-FOOT BLK**

LH-32-8001-2999-BK24

**3-FOOT CYB**

LH-32-8001-2999-CB36

**2-FOOT CYB**

LH-32-8001-2999-CB24

**3-FOOT BLK**

LH-32-8001-2999-BK36

**4-FOOT CYB**

LH-32-8001-2999-CB48

**4-FOOT BLK**

LH-32-8001-2999-BK48





**LH-32-9001-2999-BK24**  
Single leg lanyard with FP-9001+FP-2999

**2-FOOT BLK**

LH-32-9001-2999-BK24

**2-FOOT CYB**

LH-32-9001-2999-CB24

**3-FOOT BLK**

LH-32-9001-2999-BK36

**4-FOOT CYB**

LH-32-9001-2999-CB48

**3-FOOT CYB**

LH-32-9001-2999-CB36

**4-FOOT BLK**

LH-32-9001-2999-BK48



**LH-32-HL-2999-BK24**  
Single leg lanyard with hitched loop+FP-2999

**2-FOOT BLK**

LH-32-HL-2999-BK24

**3-FOOT CYB**

LH-32-HL-2999-CB36

**2-FOOT CYB**

LH-32-HL-2999-CB24

**4-FOOT CYB**

LH-32-HL-2999-CB48

**3-FOOT BLK**

LH-32-HL-2999-BK36

**4-FOOT BLK**

LH-32-HL-2999-BK48



**LH-32-HL-8001-BK24**  
Single leg lanyard with hitched loop+FP-8001

**2-FOOT BLK**

LH-32-HL-8001-BK24

**2-FOOT CYB**

LH-32-HL-8001-CB24

**3-FOOT BLK**

LH-32-HL-8001-BK36

**4-FOOT CYB**

LH-32-HL-8001-CB48

**3-FOOT CYB**

LH-32-HL-8001-CB36

**4-FOOT BLK**

LH-32-HL-8001-BK48



**MADE IN THE USA**

**2-FOOT BLK**

LH-32-FORG-2999-BK24

**2-FOOT CYB**

LH-32-FORG-2999-CB24

**3-FOOT BLK**

LH-32-FORG-2999-BK36

**4-FOOT CYB**

LH-32-FORG-2999-CB48

**4-FOOT BLK**

LH-32-FORG-2999-BK48

**3-FOOT CYB**

LH-32-FORG-2999-CB36



**LH-32-FROG-8001-BK24**  
Single leg lanyard with FROG+FP-8001

**2-FOOT BLK**

LH-32-FROG-8001-BK24

**3-FOOT CYB**

LH-32-FROG-8001-CB36

**2-FOOT CYB**

LH-32-FROG-8001-CB24

**4-FOOT CYB**

LH-32-FROG-8001-CB48

**3-FOOT BLK**

LH-32-FROG-8001-BK36

**4-FOOT BLK**

LH-32-FROG-8001-BK48



**LYH-32-8001-2999-BK24**  
Twin-legged lanyard with FP-8001+FP-2999

**2-FOOT BLK**  
LYH-32-8001-2999-BK24

**2-FOOT CYB**  
LYH-32-8001-2999-CB24

**3-FOOT BLK**  
LYH-32-8001-2999-BK36

**4-FOOT CYB**  
LYH-32-8001-2999-CB48

**3-FOOT CYB**  
LYH-32-8001-2999-CB36

**4-FOOT BLK**  
LYH-32-8001-2999-BK48



**LYH-12-8001-2999-BK24**  
Twin-legged lanyard with FP-8001+FP-2999

**2-FOOT BLK**  
LYH-12-8001-2999-BK24

**3-FOOT CYB**  
LYH-12-8001-2999-CB36

**2-FOOT CYB**  
LYH-12-8001-2999-CB24

**3-FOOT BLK**  
LYH-12-8001-2999-BK36

**4-FOOT CYB**  
LYH-12-8001-2999-CB48

**4-FOOT BLK**  
LYH-12-8001-2999-BK48



## TROUSER BELTS

1.5 INCH (including binding)

Belt can be made with or without



Belt Sizing	
SMALL	28" - 33"
MEDIUM	33" - 38"
LARGE	38" - 43"
XLARGE	43" - 48"

Constructed out of 1.5" coated MIL-SPEC Type 13 webbing and equipped with or without the 1" Raptor™ quick-release aluminum buckle. These belts are designed to fit through most 2" belt loops (even jeans!) for daily wear. Buckles are rated at 2,000 lb (9kN) for direct pull and webbings are rated at 5,000 lb or more.



ORIGINAL

TB-A-8128-24



The entry level edition of the FUSION inside liner belt is 1 layer of 1.5" coated MIL-SPEC Type 13 webbing. It offers medium stiffness with nylon webbing on the outside and Velcro loop lining on the inside. The entire belt has sewn binding that adds comfort for long hours of wear without chafing the users hips. Comes on and off easily with hook and loop closure.

IMPACT

TB-B-8126-23



One of the most popular belts from the FUSION Trousers Belt Collection, IMPACT has a clean appearance, double layered 1.5" coated MIL-SPEC Type 13 webbing with a 2,000+ lb rated Raptor™ quick-release aluminum buckle. This allows for easy, single-handed manipulation. The stiff, resin-treated, single-layer webbing offers durability yet keeps the belt light and low-profiled. The 1.5" webbing allows the user to easily pass the belt through BDU's or pants. This belt features amazing flexibility without compromising daily use durability.

TITUS

TB-C-8126-23



The TITUS is here! This FUSION Trousers Belt is the ultimate go-to belt for both lasting wear and comfort. The TITUS Belt is constructed of two layered MIL-SPEC webbing, and features the Raptor™ quick-release aluminum buckle for easy on and off. It allows the user to pass the belt through the belt loop without having to remove the buckle. The dual-layer MIL-SPEC webbing offers support without giving up comfortability for the wearer.

## TROUSER BELTS

ERA

TB-D-8126-24

  
 FLG  
 BLK  
 CYB  
 CAMO



The ERA edition of the FUSION Trousers Belt is constructed with two-layers of MIL-SPEC webbing. ERA features a Raptor™ quick-release aluminum buckle for easy on and off that allows the user to pass the belt through belt loops without removing the buckle. The base of the belt uses 1.5" MIL-SPEC webbing with an additional top layer of 1" stiff MIL-SPEC webbing for extra support, without sacrificing the flexibility of the belt. Era has nylon binding around to prevent fraying of the webbing. This is the ultimate belt for carrying a concealed weapon while not sagging the belt.

ELITE

TB-E-8626-24



The ELITE FUSION Trousers Belt is the first of its kind. Don't be fooled by it's refined finish; This belt is not just about appearance, but also offers performance. The medium-stiffness base layer uses a MIL-SPEC Type-II 5,000 lb rated webbing with resin treatment. The outer, double layered 1.5" MIL-SPEC webbing is wrapped with an outer layer of vinyl with Carbon Fiber print. The entire belt's edge has nylon binding for added comfort and durability for extended use. Equipped with a 1" Raptor™ quick-release aluminum buckle, it is adjustable from the inside to show a clean exterior.

EXO

TB-F-8926-23



This versatile DIY/EDC belt combo comes standard with one black Raptor™ quick-release aluminum buckle and three of our most popular belt colors: Black, Coyote Brown, and Foliage Green. The EXO Combo is designed for the user to have the ability to mix and match the color belt to the uniform of the day or whatever color your kydex holster is. With a double-layer of MIL-SPEC webbing and extreme versatility this belt pack is perfect for the everyday user.

## TROUSER BELTS

### NOBLE

TB-G-8726-24



The NOBLE Belt features a heavy-duty, basket weave nylon granite that looks like but outlasts leather, and wears like granite; in which it will retain its shape for much longer. This belt comes with a low-profile Raptor™ quick-release aluminum buckle, with a high breaking strength of direct pull 9kN (2,000 lb). Constructed of double layer 1.5" coated MIL-SPEC webbing and a 1.5" wide nylon padding for comfort. The NOBLE can be adjusted for a better fit with the velcro tabs and loops to hold the velcro in place. The buckle fastens securely and removes with the push of the two-stage tabs on both sides, meaning you won't have any accidental disengagement of the buckle.

### HONOR

TB-H-8726-23

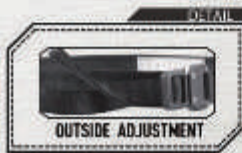

The HONOR Trousers Belt is the ultimate go-to for lasting wear and comfort. Constructed of two layered 1.5" MIL-SPEC webbing, one 1" layer on the outside, and featuring the Raptor™ quick-release aluminum buckle for easy on/off. This belt easily passes through belt loops without needing to remove the buckle. The dual-layer webbing offers support without giving up flexibility for the wearer. Has a two-stage velcro tab for adjustment.

### EPIC INTERIOR

TB-J-8126-13



Our Epic Trousers Belt is a light duty liner belt; light weight, constructed of a single layer of 5,000 lb rated 1.5" base webbing, soft to the touch, yet rigid enough to be worn daily and/or carry conceals. The belt is equipped with velcro loop on the outer layer for quick attachment to the FUSION Epic MOLLE Belt and/or the Modular Belt System in seconds.

## RIGGERS BELTS

1.5, 1.75, & 2 INCH

Belt can be made with or without



Top and Loops

Bottom

Belt Sizing

SMALL	28" - 33"
MEDIUM	33" - 38"
LARGE	38" - 43"
XLARGE	43" - 48"

These belts can be constructed of two-layered 1.5", 1.75", or 2" coated MIL-SPEC Type 13 webbing and equipped with one of four different buckle options. Five rows of stitching reinforce the stiffness of these belts. Designed for Riggers and considered a second chance rappelling device. Our buckles carry a rating of 4,000 lb indirect pull.

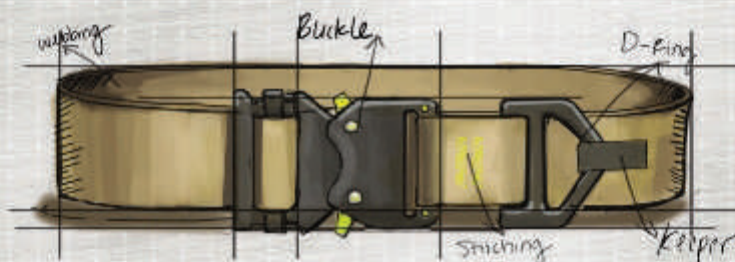

UNDEFEATED

RB-A-1211-31

FLG  
BLK  
CYB  
CAMO



The UNDEFEATED Riggers Belt consists of two layered 1.75" coated MIL-SPEC Type 13 webbing and equipped with a Raptor™ quick-release aluminum buckle. It also features a reinforced loop and five rows of stitching that increases the belt's stiffness without compromising flexibility. Designed for Riggers and considered a second chance rappelling device.

## TROUSER BELTS

### CORE

RB-B-1212-31



The CORE Riggers Belt features two layered 1.75" coated MIL-SPEC Type 13 webbing and equipped with a Presto™ quick-release steel buckle. It also features five rows of stitching reinforcing the belt's stiffness without compromising its flexibility as well as a reinforced loop. Designed for Riggers and considered a second chance rappelling device.

### BUCK

RB-C-2212-31

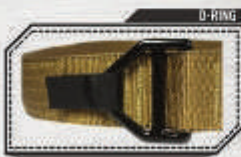

The BUCK Riggers Belt features two layered 1.75" coated MIL-SPEC Type 13 webbing and equipped with a Presto™ quick-release steel buckle. It also features five rows of stitching that reinforce the belt's stiffness without compromising its flexibility as well as a Delta ring. Designed for Riggers and considered a second chance rappelling device.

### TYPHOON

RB-D-2213-31



The TYPHOON Riggers Belt features two layered 1.75" coated MIL-SPEC Type 13 webbing and equipped with an adjustable steel buckle. It also features five rows of stitching that reinforce the belt's stiffness without compromising its flexibility as well as a Delta ring. Designed for Riggers and considered a second chance rappelling device.

### BASAL

RB-E-6218-31

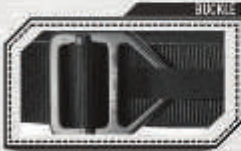

EUSION's BASAL is the most basic and streamlined of our Riggers Belt's. Constructed of two layered 1.75" coated MIL-SPEC Type 13 webbing, five rows of stitching and featuring the steel Delta ring with slider. Bar-tack stitching with a velcro keeper allows for a secure and low-profiled fit. Available in three colors: Black, Coyote Brown, and Foliage



## PATROL BELTS

2/2.25 INCH

Belt can be made with or without



Raptor Logo

Buckle

Belt Sizing

SMALL	28" - 33"
MEDIUM	33" - 38"
LARGE	38" - 43"
XLARGE	43" - 48"

Made out of 2" or 2.25" wide coated MIL SPEC Type 13 webbing and equipped with a Raptor™ quick release aluminum buckle. These belts are designed for patrol officers or tactical use due to the velcro lining on the interior. The binding on the edges give a refined finish to match with issued uniforms and are compatible with most holsters! Our buckles carry a rating of 4,000 lb indirect pull.

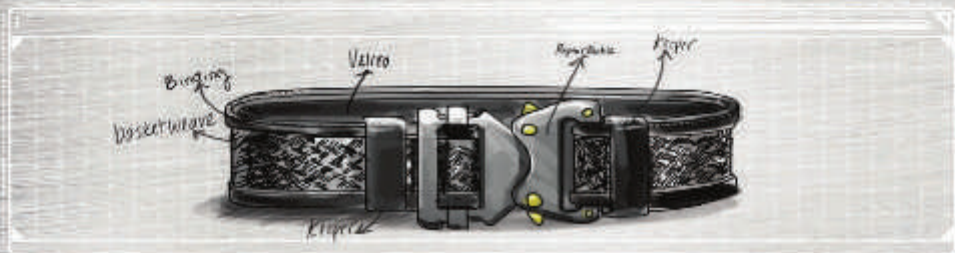

### PREMIER

PR-A-8731-54



The PREMIER Patrol Belt is constructed of 2" or 2.25" wide basket weave, MIL-SPEC Type 13 webbing and equipped with a Raptor™ quick-release aluminum buckle. Our Patrol Belts are designed for patrol officers or for tactical use with an inner velcro lining. The binding on the edges provide more durability as well as a refined finish to compliment issued uniforms. Features two belt keepers on each side of the buckle and is inside-adjustable. Compatible with most holsters.

### CHOICE

PR-B-8111-44



The CHOICE Patrol Belt is an outer belt, 2" or 2.25" in width with three layers of MIL-SPEC Type 13 webbing that is resin treated for extra stiffness. The Patrol Belt is designed for patrol officers to carry their equipment: i.e. Handcuffs, radio, baton, firearms, ammunition, taser, flashlight, etc. The key feature of the Patrol Belt is that it is paired with an Raptor™ quick-release aluminum buckle that has a rating of 4,000 lb. The CHOICE has a double-locking design to prevent accidental opening when engaged in close combat situations. The nylon core has seven rows of reinforced T-131 nylon thread stitching allowing the belt to maintain rigidity to support the weight of the equipment while still offering the flexibility needed when engaged in physical activity. To further secure gear, the inside lining of the belt includes a layer of velcro loop.

## MBC-PR-A-8712-5181



- Raptor™ quick-release aluminum buckle
- High density impregnated Velcro
- Three rows reinforced triple stitching & bar tack with T131 nylon bonded thread
- UV/Resin coated MIL-SPEC Type 13 webbing
- Built-in Belt Keepers
- Hook & loop double interior velcro adjustment
- 3-tiered section prevents sagging
- Available in 4 sizes: S, M, L, & XL



### 1.5" BLACK INTERIOR TROUSER BELT

Our interior Trousers Belt is a light duty liner belt: light weight, single layer 5,000 lb rated webbing. The locking mechanism of the belt uses the Raptor™ quick-release aluminum buckle for a light weight and low profile fit. The webbing itself is soft to the touch, yet rigid enough to be worn daily and/or concealment carry. It is equipped with a Velcro loop on the outer layer for quick attachment to the Modular Waist Pad in seconds.



### BLACK MODULAR EVA WAIST PAD 4.5" WIDE

This dynamic lumbar support pad wraps around your waist in seconds. It is incredibly light weight while still offering comfortable support. Constructed with closed-cell EVA memory foam with multi-layer design, the inner pad has mesh lining for moisture control and quick drying properties. The layers are then sandwiched with medium-soft density foam for structural support. The final outer layer is lined with a water repellent 500D Denier nylon for maximum wear resistance. The waist pad is a generous 4.5" in width for maximum comfortability and support. The combination of stationary and customizable belt loops on the pad allow for gear and kit to pass through with little effort while maintaining a snug fit.



### BLACK BASKET WEAVE 2.25" EXTERIOR PATROL BELT

The basket weave patrol belt is both versatile and functional. It is 2.25" in width constructed of multiple sandwiched layers. Build materials include vinyl basket weave on the outside, reinforced with EVA foam for maximum cushioning, and a stabilizer polypro plate in the center. This belt uses the Raptor™ quick-release aluminum buckle with adjustment on both sides of the buckle for a secure and quick donning and doffing.



# SHOOTERS BELTS

2 INCH



Belt can be made with or without

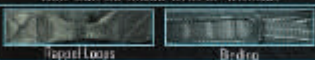

Rappel Loops

Buckle

Belt Sizing

SMALL	28" - 33"
MEDIUM	33" - 38"
LARGE	38" - 43"
XLARGE	43" - 48"

Made out of three layers of 2" wide MIL-SPEC webbing and equipped with the Raptor™ quick-release aluminum buckle. Seven rows of stitching reinforce the stiffness of the belt. Designed with a full-strength, reinforced nylon loop (5,000 lb rated!) located the rear for emergency rappel situations and/or HELO retention.

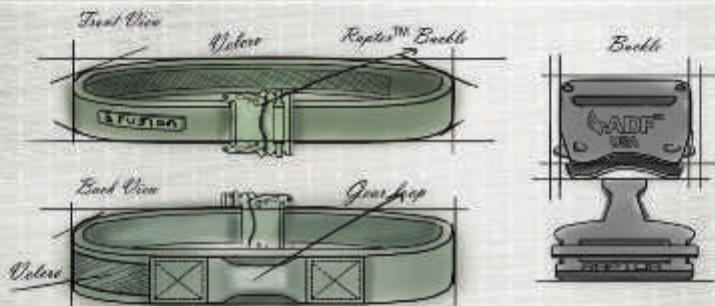

MAX

SB-A-1121-41



FRONT



BACK

FLG

BLK

CYB

CAMO



## HIGH VISIBILITY BELT

1.75 INCH

Belt can be made with or without



Reinforced Loop

Buckle

Belt Sizing

SMALL	28" - 33"
MEDIUM	33" - 38"
LARGE	38" - 43"
XLARGE	43" - 48"

Constructed of two layers of 1.75" wide coated MIL-SPEC Type 13 webbing, equipped with a Raptor™ quick-release aluminum buckle and a single strip of removable High-Visibility material. These belts are designed for patrol officers or tactical use due to the velcro lining on the inside. The binding at the edges give a refined finish to match with issued uniforms and are compatible with most holsters.



AEROS-HD

HB-A-1021-36

-  NEON-GREEN
-  NEON-YELLOW
-  NEON-ORANGE
-  NEON-PINK



Be safe and be seen with the High Visibility (Type A) Belt. Constructed of 1.75" wide double-layer MIL-SPEC Type 13 webbing and equipped with a quick-release buckle, this belt features a velcro-lined exterior for easily attaching/detaching the included High-Vis strip. Includes a 5,000 lb rated reinforced nylon loop in front and is inside-adjustable.



AEROS-LITE

HB-D-1821-35

-  YELLOW



The High Visibility (Type D) Belt is constructed of 1.75" wide double-layer MIL-SPEC Type 13 webbing and is secured with hook & loop closure. This belt features a High-Vis exterior for wearers to be safely seen. Excess material can be secured neatly with an included elastic belt keeper and is outside-adjustable.

## BATTLE BELT

MULTIPLE



- Raptor™ quick release aluminum buckles
- High density impregnated velcro
- Reinforced bar tack and triple stitching with T131 nylon bonded thread.
- UV/Resin coated MIL-SPEC Type 13 webbing
- Steel Delta ring
- Built-in Belt Keepers
- Hook & loop double interior velcro adjustment
- 3-tiered section prevents sagging
- Available in 4 sizes: S, M, L, & XL

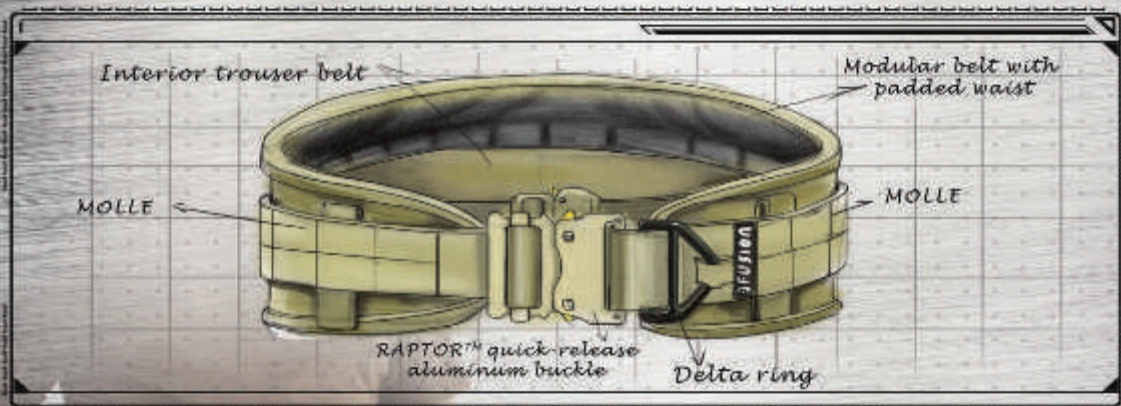

## EPIC BATTLE BELT

MBC-BB-B-2221-5181



COLOR OPTIONS

	BLK		ODG		CYB		CAMO
--	-----	--	-----	--	-----	--	------

### EPIC INTERIOR TROUSER BELT

Our Epic Trouser Belt is a light duty liner belt; light weight, constructed of a single layer of 5,000 lb rated 1.5" base webbing, soft to the touch, yet rigid enough to be worn daily and/or while carrying concealed. The belt is equipped with a velcro loop on the outer layer for quick attachment to the Fusion Epic MOLLE Belt and/or the Modular Belt system in seconds.

### EPIC MODULAR EVA WAIST PAD

Our Modular Pad System can be attached and detached as needed to be ready for any exercise or mission. Made with 4.5" EVA Memory Foam for lumbar support helping to spread out the belt load evenly. The inside of the pad is equipped with mesh lining for moisture control, full length velcro hook material for quick attachment to the Epic MOLLE Belt. One side has a full length 1.5" velcro hook, and the other has the 1.5" loop to go with multiple system configurations. This pad has positive buoyancy and quick drying properties.

### EPIC 16-SLOT MOLLE BELT WITH RAPTOR™ QUICK-RELEASE ALUMINUM BUCKLE

This awesome utilitarian belt is made from 5,000 lb rated UV/resin treated MIL-SPEC Type 13 webbing, with MOLLE surrounding the outer belt. The inner belt lining includes velcro hooks that can be used to adapt to your trouser belt with minimal shifting in movement making it a singular unit design. Equipped with the Raptor™ quick-release aluminum buckle for fast donning and doffing, the rigid wall construction is reinforced with three layers of webbing, and a load bearing escape/utility loop when needed making this the best load bearing duty belt on the market.

## BATTLE BELT

### CUSTOMIZABLE GHOST MOLLE FLAP

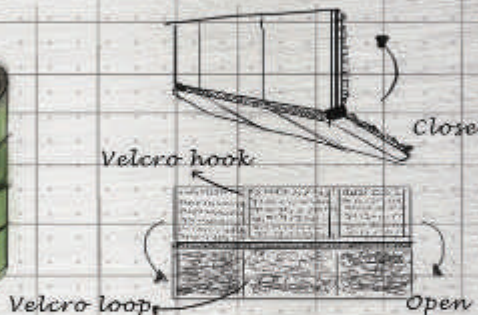

## TRIDENT MOLLE BATTLE BELT

MB-BB-D-2201-014A



COLOR  
OPTIONS



BLK



ODG



CYB



CAMO



STEEL DELTA RING



61 ALUMINUM RAPTOR™ BUCKLE

The uniquely designed TRIDENT utility belt from FUSION offers the ultimate blend of versatility and durability. This system allows you plenty of space to equip and carry the exact loadout required for any mission or exercise. The TRIDENT uses the Ghost MOLLE Flap technology that could be deployed and customized in seconds. Quality stitching and super strong nylon bonded T-131 thread are used to enhance the MOLLE's capacity and durability. This belt is also compatible with FUSION EPIC Pad for added lumbar support when carrying heavier loads or gear. Proudly made in the USA.



- 5,000 lb rated resin treated webbing offering additional support where you need it most
- Natural contour of the belt wraps around your waist like a glove
- Ghost MOLLE flaps can be folded inward when not in use; quick pull downward for customizing gear location on flap
- Escape-ready D-ring with keeper for emergency use
- The superb durability of the quick-release aluminum Raptor™ buckle has a bearing capacity of 4,000 lb IDP - allows for quick donning and doffing in seconds





# BELT KEEPERS

## TYPE 1

The FUSION Velcro Belt Keepers are highly versatile and able to accommodate thick or thin belts. The velcro helps keep belt tightly together for everyday use. Stitched with nylon bonded thread for durable wear. Comes in a pack of four and available in Black, Coyote Brown, and Foliage Green. Fits up to a 2.25" belt. Webbing rated at 5,000 lb.



### COLOR OPTIONS

BLK



CYB



FLG



BA-BK-8188-38



BA-BK-8188-28



BA-BK-8188-18



SHOWN HERE ON OUR PREMIER PATROL BELT

		WEBBING WIDTH		
		1"	1.5"	1.75"
COLOR	BLK	BA-BK-8188-18	BA-BK-8188-28	BA-BK-8188-38
	CYB	BA-BK-8288-18	BA-BK-8288-28	BA-BK-8288-38
	FLG	BA-BK-8388-18	BA-BK-8388-28	BA-BK-8388-38

## TYPE 2



BA-BK-8189-19



Our Velcro Belt Keepers are versatile and able to accommodate any belt. This belt keeper features nylon webbing stitched with nylon bonded thread for extra durable wear as well as a hasp pin, snap shackle on one end. Available in black, coyote brown, and foliage green. Features velcro and snap-button closure. Can be latched on with any standard MOLLE system. Only available in 1" and fits 1.5" up to a 2.25" wide belt.



# LEG HOLSTER STRAP

## TYPE 1-VELCRO

BA-SR-8181-48

Velcro enclosure

OPEN  
LOOP



## TYPE 2-FIXED

BA-SR-8181-47

FIXED  
LOOP



Leg holster replacement strap can help you replace the worn out plastic buckles yourself. This drop down kit is designed to be compact and low profile and minimize shifting while in motion. 5000lbs rated webbing and high strength T138 quick release light weight aluminum buckles. Made in USA buckles! Available in 2", 3", or 4"

- t Available in 2" webbing width
- t The Drop Down replacement strap is designed to be compact and low profile
- t Tight enclosure to minimize shifting while in motion (max 2")
- t UV and resin treated webbing has 5,000 lb rated breaking strength and is abrasion resistant
- t Raptor™ quick-release aluminum buckles are rated at 4,000 lb (indirect pull) and much stronger than plastic
- t High-strength T138 nylon bonded thread for resistance against wear and tear
- t All belts are made in Chino, California. We strive to support our local labor force by keeping jobs in the USA

## AVAILABLE COLORS

BLK



CYB



FLG



BEFORE



EASY TO REPLACE

AFTER



# GUN SLINGS

## STANDARD

ITEM NO: GS-A-1183-18

HEAVY DUTY  
1.25" WEBBING



2 INNER  
BUNGEE CORDS

### FEATURES

- Raptor™ aluminum buckle rated for 9 kN (2,000 lb) direct pull (plastic buckle also available)
- Two (4,000 lb rated) MIL-SPEC/elastic inner bungee sections
- Single locking metal snaphook
- Includes QD (Quick Detach) area
- Convenient adjustment strap
- 1.25" (2,000 lb rated) webbing



## QWIK QUIET

ITEM NO: GS-B-2182-18



### HOOK OPTIONS

HK



PUSH



SNAP



### COLOR OPTIONS

BLK



CYB



ODG



### BUCKLE OPTIONS



Aluminum  
RAPTOR™ Buckle  
rated at direct pull  
9kN/2,000 lb



Plastic  
Buckle  
Option

**UNIVERSAL**

ITEM NO: GS-C-3113-38



TWO TO ONE

**FEATURES**

- Berry Amendment Compliant
- Single and two-point connection
- Precision-cast metal OD-ring
- Available in 3 colors: Black, Coyote Brown, and OD Green
- 1.5" 800 lb rated nylon webbing

**2PT**

ITEM NO: GS-D-1884-38



**FEATURES**

- Sling length: 40-57"
- Two-point connection with steel HK hooks
- 1.75" elastic MIL-SPEC webbing
- Non-slip, quick-release, side buckle
- Available in Black, CYB, and ODG

**HOOK OPTIONS**

HK



PUSH



SNAP



**COLOR OPTIONS**

BLK



CYB



ODG



**BUCKLE OPTIONS**



Aluminum  
**RAPTOR™** Buckle  
rated at direct pull  
9kN/2,000 lb



Plastic  
Buckle  
Option

# BUCKLE OPTIONS

## RAPTOR™

Anti-Pivot design

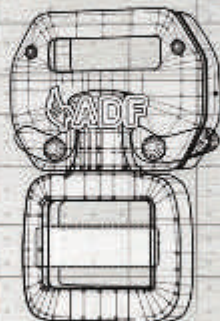
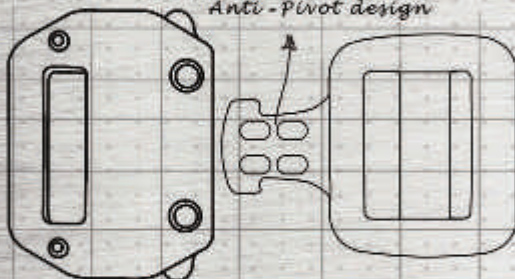

3<sup>RD</sup> PARTY TESTED: SAND BLAST MIL-STD 810, SALT SPRAY 50 HOURS,  
SALT WATER 24 HOURS, TENSILE TEST

1.00"

1.50"

1.75"

2.00"



CUSTOMIZE WITH YOUR BRAND'S LOGO



### PRODUCT FEATURES

- U.S. Patented design; Anti-Pivot System
- Uniform dimension for versatile applications
- High-speed operation without compromising safety
- Generous opening of adjuster bar
- Aluminum forged housing
- Third-party tested

COLOR OPTIONS: BLUE GREEN

BROWN RED GREY GOLD BLACK

OTHER BUCKLE OPTIONS

FP-2106-8



FP-2013



FP-2137



FP-2139-3



# CARABINERS AND GEAR

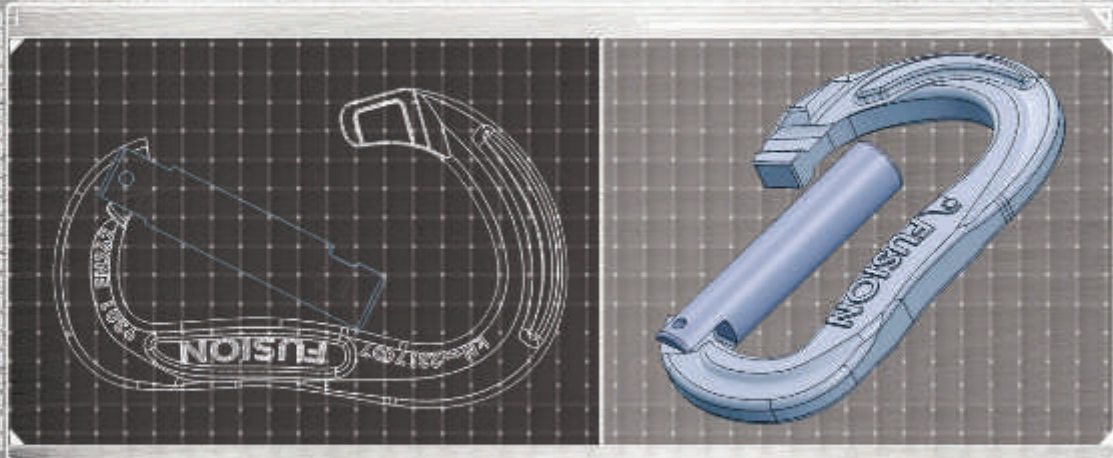

## ALUMINUM CARABINERS



**FP-9301-1A-SP-BKBK**  
STRAIGHT GATE PIN NOSE



Finish : Anodized  
MBS : 25 kN



**FP-9313-2A-AK-BKBK**  
AUTO-LOCKING KEY NOSE



Finish : Anodized  
MBS : 28 kN



**FP-9307-7A-SK-BKBK**  
STRAIGHT GATE KEY NOSE



Finish : Anodized  
MBS : 25 kN



**FP-8122-1A-BP-BKBK**  
BENT GATE PIN NOSE



Finish : Anodized  
MBS : 25 kN



**FP-8122-1A-RP-BKBK**  
SCREW GATE PIN NOSE



Finish : Anodized  
MBS : 25 kN



**FP-8122-1A-AP-BKBK**  
AUTO-LOCKING PIN NOSE



Finish : Anodized  
MBS : 25 kN



**FP-9318-3A-SK-BKBK**  
STRAIGHT GATE KEY NOSE



Finish : Anodized  
MBS : 23 kN



**FP-9318-3A-RK-BKBK**  
SCREW GATE KEY NOSE



Finish : Anodized  
MBS : 23 kN



**FP-9320-3A-RP-BKBK**  
SCREW GATE PIN NOSE



Finish : Anodized  
MBS : 28 kN



**FP-9351-1A-AK-BKBK**  
AUTO-LOCKING KEY NOSE



Finish : Anodized  
MBS : 28 kN

## STEEL CARABINERS



**FP-9108-1S-AP-BKBK**

AUTO-LOCKING PIN NOSE



Finish : E Coating  
MBS : 27 kN



**FP-9104-1S-RP-BKBK**

SCREW GATE PIN NOSE



Finish : E Coating  
MBS : 27 kN



**FP-9005-1S-RP-BKBK**

SCREW GATE PIN NOSE



Finish : E Coating  
MBS : 50 kN



**FP-9005-1S-AKP-BKBK**

AUTO-LOCKING KEY NOSE



Finish : E Coating  
MBS : 50 kN



**FP-9005-1S-TKP-BKBK**

TRIPLE LOCK KEY NOSE



Finish : E Coating  
MBS : 60 kN



**FP-9008-1S-RK-BKBK**

SCREW GATE KEY NOSE



Finish : E Coating  
MBS : 50 kN



**FP-9202-1S-APP-BKBK**

AUTO-LOCKING PIN NOSE



Finish : E Coating  
MBS : 60 kN



**FP-9202-1S-APHP-BKBK**

AUTO-LOCKING PIN NOSE



Finish : E Coating  
MBS : 60 kN

## RIGGING GEAR

FIGURE 8



**FP-8143-BLK**  
MBS : 35 kN

TERMINAL 8



**FP-8145-BLK**  
MBS : 50 kN

BIG FOOT



**FP-8144-2-BLK**  
MBS : 40 kN

LITTLE FOOT



**FP-8144-3-BLK**  
MBS : 30 kN

COMPACT BENT 8



**FP-8146-2-BLK**  
MBS : 25 kN

DELTA SWIVEL



**FP-8300-BLK**  
MBS : 36 kN

SWIVEL



**FP-8310-BLK**  
MBS : 36 kN

SHACKLE SWIVEL



**FP-8320-BLK**  
MBS : 36 kN



# HARDWARE / WEBBING

## PULLEYS



**FP-8149**  
FIXED SIDE PULLEY  
MBS : 20 kN



**FP-8151**  
MICRO PULLEY  
MBS : 20 kN



**FP-8152**  
STRUX PULLEY  
MBS : 34 kN



**FP-8154**  
TESA SPEED PULLEY  
MBS : 24 kN



**FP-8155**  
SECURA PULLEY  
MBS : 32 kN

## ASCENDERS & DESCENDERS



**FP-7215-LT-BK**  
SUPRA ASCENDER



**FP-7215-RT-BK**  
SUPRA ASCENDER



**FP-7216-BK**  
SUPRA-DUAL ASCENDER



**FP-7218-BK**  
KASTER ASCENDER



**FP-7208-AL-BLK**  
PUMA GRAB II



**FP-8166-3**  
O-RING  
MBS : 25 kN

## HARDWARE



**FP-2999**  
QUICK-RELEASE  
SNAP SHACKLE

MBS : 18 kN

30F RATED  
WITH ANTI-FAIL  
OPTION WELDED  
RING AND  
SWAGED PIN  
AND PULL TAG



**BH-1012-BLK**  
CABAL STEEL

MBS : 30 kN



**FROG**

MBS : 25 kN



**FP-8001-BLK**  
SNAP HOOK

MBS : 32 kN

## WEB SLINGS

### STANDARD DAISY CHAIN

QD-2015-120-BLK

- 19mm (0.75") wide nylon webbing with reinforced stitching
- 12 stitched loops
- Length: 36"
- Fall protection use
- MBS: 5000 lb



### INDIVIDUAL LOOP DAISY CHAIN

QD-3015-BLK

- 19mm (0.75") wide nylon webbing with reinforced stitching
- 7 stitched loops
- Length: 46"
- Fall protection use
- MBS: 5000 lb



### ATRIER (AID LADDER)

QD-4000-BLK

- 19 mm (0.75") wide nylon webbing
- Attached velcro pouch for convenient storage
- Length: 66" or 5 ft
- Four reinforced steps



### STITCHED NYLON LOOPS

QD-1511-60-SLING

QD-1511-80-SLING

QD-1511-120-SLING

- 19mm (0.75") wide nylon webbing
- Available lengths: 60 cm (24"), 80 cm (30"), 120 cm (48")
- Fall protection use
- MBS: 5000 lb



# K9 TREKKER COLLAR

Ergonomically designed to accommodate everyday training and work

MADE IN THE USA

TK-102-BLK



COLLAR



FRONT VIEW

COLLAR



BACK VIEW

DETAILS



Rubberized handle bar for better control and comfort for the handler



5,000 lb rated large parachute style D-ring for easy latch and durable use



**RAPTOR™**  
Quick-Release Buckle



Padded EVA and mesh system designed to protect the buckle from friction and wear on the body of K9

Webbing: MIL-SPEC 5,000 lb rated Resin UV treated nylon webbing.

Stitching: T-131 nylon bonded thread

Color: Available in **Black** or **Coyote**

Please note: To measure your dog's girth, you must measure all the way around the rib cage in a full circle. Please contact a FUSION representative for any customizations.



SIZING CHART

SIZE	NECK
M	19"-22"
L	23"-27"
XL	28"-32"

# TREKKER HI-VIS

## HI-VIS K9 COLLAR



The K9 TREKKER Collar is ergonomically designed to accommodate everyday training and work. Constructed of 5,000 lb rated resin/UV coated, MIL-SPEC nylon webbing with T-131 nylon bonded thread for extra durability. Features a rubberized handle bar for better control and comfort for the handler. The 5,000 lb rated large parachute style D-ring is made for easy latch and durable use while the Raptor™ quick-release aluminum buckle allows for quick and easy on/off. The padded EVA and mesh system protects the buckle from constant friction and wear. The collar also features High-Visibility strips which aids your pet to be seen in dimly-lit environments.

AVAILABLE IN ORANGE, BLACK, COYOTE, or RED



# K9 TREKKER HARNESS

Ergonomically designed to accommodate everyday training and work

TK-101-BLK



Quick-release handle



TK-101

ONE HANDLE



TK-101-2

DUAL HANDLES



DETAILS



Rubberized handle bar for better control and comfort for the handler



5,000 lb rated large parachute style D-ring for easy latch and durable use



**RAPTOR™**  
Quick-Release  
G2 Buckle



Padded EVA and mesh system designed to protect the buckle from friction and wear on the body of K9

Webbing: MIL-SPEC 5,000 lb rated Resin UV treated nylon webbing

Stitching: T-131 nylon bonded thread

Color: Available in **Black** or **Coyote**

SIZING CHART

Please note: To measure your dog's girth, you must measure all the way around the rib cage in a full circle. Please contact a FUSION representative for any customizations.



SIZE	GIRTH	NECK
M	19"-25"	19"-22"
L	26"-32"	23"-27"
XL	33"-39"	28"-32"

# K9 TREKKER COMBO

TK-101-COMBO

## TREKKER COMBO

The K9 TREKKER Harness allows the handler to easily control and access the K9 in motion. The 1,200 lb rated handle is detachable so the dog can easily squeeze into tight spaces. The use of 9kN (2,000 lb) indirect pull, Raptor™ quick-release aluminum buckle make this one of the toughest K9 Harnesses on the market. Heavy-duty, nylon bonded threads and MIL-SPEC webbing ensures durability. Division or unit identification patch can be mounted on with built-in hook and loop velcro. The EVA padded chest piece offers maximum comfort and stability for K9 even during hard pulling. Manufactured with a cooling pack compartment to keep your four-legged companion fresh while on the job. The K9 TREKKER Harness is available on its own or as part of our TREKKER Combo which includes a Riggers Belt with a reinforced loop, a carabiner, and a bungee leash with quick-release snap shackle.



## HANDS-FREE SYSTEM



TK-101



RIGGERS BELT



FP-9301-ST-BLK



TKL-9006

Pouch for cooling pack

# K9 LEASHES



## K9 LEASH

The FUSION K9 Leash is an essential training aid for any K9 handler. Constructed of 5,000 lb rated webbing, the K9 Leash is produced with either flat webbing or bungee style and is hand-made here in the USA. Various standard lengths are available with custom lengths optional on request. The bungee leash can be used with a new recruit all the way up to the most experienced police K9.

### FUSION K9 Anti-Shock System

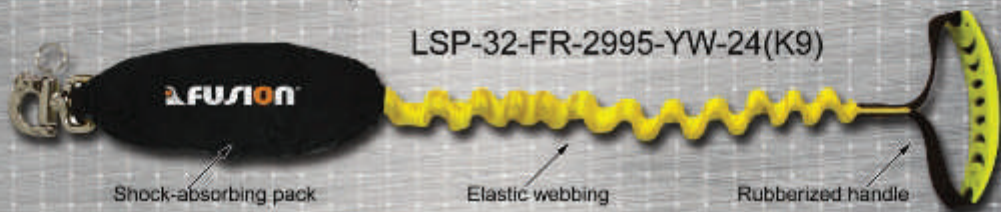

In 2016, we produced a newly designed FUSION K9 Anti-Shock™ System with the goal of promoting the health and well-being of K9 handlers.

The FUSION K9 Anti-Shock™ System helps to limit the transfer of force to the handler's arm when the K9 pulls or launches forward. This greatly helps to reduce injuries such as tennis elbow and arm muscle fatigue from long periods of training or field operations.

-Bungee Lanyards: 2ft, 3ft, 6ft

-Custom lengths available on request

Extended Webbing Length	Webbing Strength	Webbing Color		Webbing Color		Webbing Color	
2 Feet	5,000 lb	BLK	LSP-32-FR-2995-BK-24(K9)	CYB	LSP-32-FR-2995-CB-24(K9)	YLW	LSP-32-FR-2995-YW-24(K9)
3 Feet	5,000 lb	BLK	LSP-32-FR-2995-BK-36(K9)	CYB	LSP-32-FR-2995-CB-36(K9)	YLW	LSP-32-FR-2995-YW-36(K9)
6 Feet	5,000 lb	BLK	LSP-32-FR-2995-BK-72(K9)	CYB	LSP-32-FR-2995-CB-72(K9)	YLW	LSP-32-FR-2995-YW-72(K9)



## ENTRY LEAD

LD-12-HL-2995-BK24

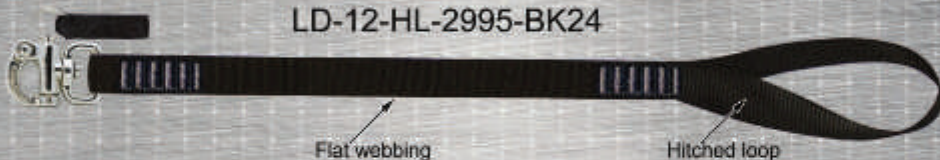

Attach the lanyard to your training or tactical belt (girth hitched to your belt loop) for hands-free usage. The quick-release shackle works great if you want to release your K9 by just pulling on the tab. Constructed with high-quality MIL-SPEC webbing (rated at 5,000 lb) and steel swivel shackle hardware.

-Fixed length lanyards: 2ft, 3ft, 6ft

-Custom lengths available on request

Webbing Length	Webbing Strength	Webbing Color		Webbing Color		Webbing Color	
2 Feet	5,000 lb	BLK	LD-12-HL-2995-BK24	CYB	LD-12-HL-2995-CB24	YLW	LD-12-HL-2995-YW24
3 Feet	5,000 lb	BLK	LD-12-HL-2995-BK39	CYB	LD-12-HL-2995-CB36	YLW	LD-12-HL-2995-YW38
6 Feet	5,000 lb	BLK	LD-12-HL-2995-BK72	CYB	LD-12-HL-2995-CB72	YLW	LD-12-HL-2995-YW72

## LONG LEASH

LD-12-FR-2999-BK72



-Fixed length lanyards: 6ft, 12ft, 18ft

-Custom lengths available on request

Webbing Length	Webbing Strength	Webbing Color		Webbing Color		Webbing Color	
6 Feet	5,000 lb	BLK	LD-12-FR-2999-BK72	CYB	LD-12-FR-2999-CB72	YLW	LD-12-FR-2999-YW72
12 Feet	5,000 lb	BLK	LD-12-FR-2999-BK144	CYB	LD-12-FR-2999-CB144	YLW	LD-12-FR-2999-YW144
18 Feet	5,000 lb	BLK	LD-12-FR-2999-BK216	CYB	LD-12-FR-2999-CB216	YLW	LD-12-FR-2999-YW216



## LONG LEASH

LD-12-FR-2999-BK240

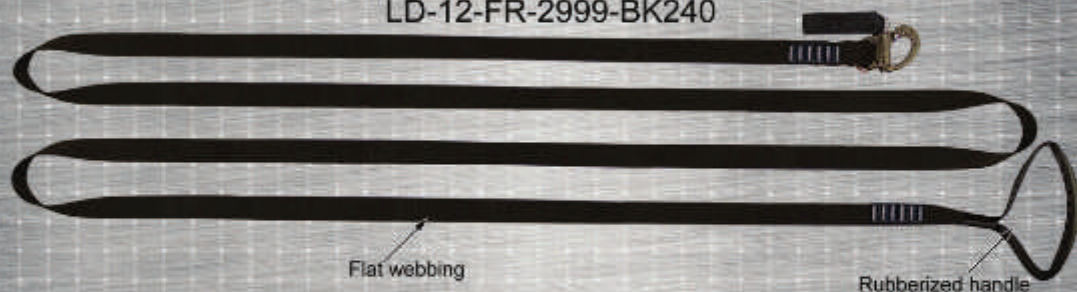

-Fixed length lanyards: 20ft, 30ft, 40ft, 50ft

-Custom lengths available on request

Webbing Length	Webbing Strength	Webbing Color	Webbing Color	Webbing Color
20 Feet	5,000 lb	BLK LD-12-FR-2999-BK240	CYB LD-12-FR-2999-CB240	YLW LD-12-FR-2999-YW240
30 Feet	5,000 lb	BLK LD-12-FR-2999-BK360	CYB LD-12-FR-2999-CB360	YLW LD-12-FR-2999-YW360
40 Feet	5,000 lb	BLK LD-12-FR-2999-BK480	CYB LD-12-FR-2999-CB480	YLW LD-12-FR-2999-YW480
50 Feet	5,000 lb	BLK LD-12-FR-2999-BK600	CYB LD-12-FR-2999-CB600	YLW LD-12-FR-2999-YW600

## DIE-ELECTRIC

LD-62-RR-9005-YW36



Webbing Length	Webbing Strength	Webbing Color	Webbing Color	Webbing Color
2 Feet	5,000 lb	BLK LD-62-RR-9005-BK24	CYB LD-62-RR-9005-CB24	YLW LD-62-RR-9005-YW24
3 Feet	5,000 lb	BLK LD-62-RR-9005-BK36	CYB LD-62-RR-9005-CB36	YLW LD-62-RR-9005-YW36
6 Feet	5,000 lb	BLK LD-62-RR-9005-BK72	CYB LD-62-RR-9005-CB72	YLW LD-62-RR-9005-YW72

## DUAL LEASH SYSTEM

LYD-32-RR-2995-BK24

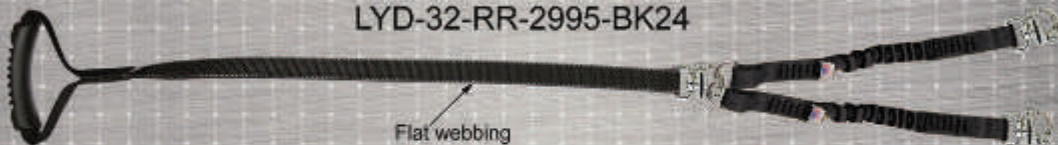

-Fixed length lanyards: 2ft, 4ft, 6ft -Custom lengths available on request

Webbing Length	Webbing Strength	Webbing Color		Webbing Color	
2 Feet	5,000 lb	BLK	LYD-32-RR-2995-BK-24	CYB	LYD-32-RR-2995-CB-24
4 Feet	5,000 lb	BLK	LYD-32-RR-2995-BK-48	CYB	LYD-32-RR-2995-CB-48
6 Feet	5,000 lb	BLK	LYD-32-RR-2995-BK-72	CYB	LYD-32-RR-2995-CB-72

## Twin-Legged Lanyard with Loop + (2) FP-2999

LYD-12-RR-2999-BK24

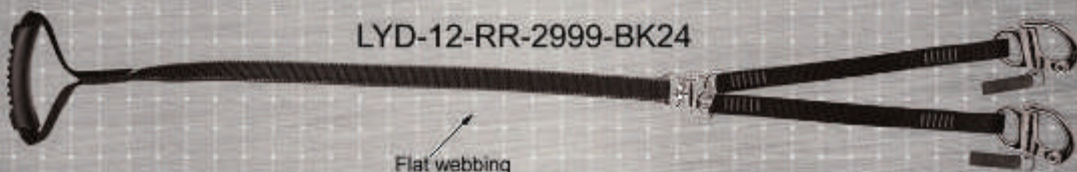

-Fixed length lanyards: 2ft, 4ft, 6ft -Custom lengths available on request

Webbing Length	Webbing Strength	Webbing Color		Webbing Color	
2 Feet	5,000 lb	BLK	LYD-12-RR-2999-BK-24	CYB	LYD-12-RR-2999-CB-24
4 Feet	5,000 lb	BLK	LYD-12-RR-2999-BK-48	CYB	LYD-12-RR-2999-CB-48
6 Feet	5,000 lb	BLK	LYD-12-RR-2999-BK-72	CYB	LYD-12-RR-2999-CB-72

## Twin-Legged Lanyard with Loop + (2) FP-8001

LYD-32-RR-8001-BK24

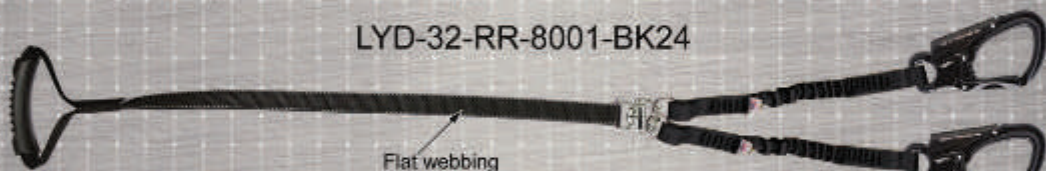

-Fixed length lanyards: 2ft, 4ft, 6ft -Custom lengths available on request

Webbing Length	Webbing Strength	Webbing Color		Webbing Color	
2 Feet	5,000 lb	BLK	LYD-32-RR-8001-BK-24	CYB	LYD-32-RR-8001-BC-24
4 Feet	5,000 lb	BLK	LYD-32-RR-8001-BK-48	CYB	LYD-32-RR-8001-BC-48
6 Feet	5,000 lb	BLK	LYD-32-RR-8001-BK-72	CYB	LYD-32-RR-8001-BC-72

# FUSION BAGS



## SPEC CHART

Pattern /Print	Color	Height	Width	Depth	Volume	Weight
Plain	 BLK  CYB  FLG	14"	25"	15"	73 L	3 lbs

## ELITE-DUFFLE

BP-16

FUSION's expertly made outdoor duffel bag helps you tackle the most challenging environments and conditions. Optimized as a go-to bag for your travels, it is made of a durable water-proof coating with heavy-duty stitching. The gear loops and compression straps allow for maximum capacity and use. Can be carried as a backpack or duffel.



## SNEAK-ORG

BP-18

This durable pack is great in the field or on the road. Features two front pockets and internal dividers where you can keep all your gear organized and easily accessible. The efficient design of this pack allows you to carry just about everything you need.



### SPEC CHART

Pattern /Print	Colors	Height	Width	Depth	Volume	Weight
Plain	BLK CYB FLG	21"	15"	9"	39 L	1.8 lbs



# BELT OPTIONS CHART

Prefix		Loops (Webbing)	Holes (Throat)	Adjustment	Suffix / Types
RB	Riggers Belt	2	5	One side	A,B,C,D,E
SB	Shooters Belt	3	7	One side	A
PR	Patrol Belt	2	5	Two sides	A,B
TB	Trouser Belt	1-3	5	One side	A,B,C,D,E,F,G,H,I
HB	High vis Belt	2	5-6	One side	A,B,C,D
BA	Belt Accessories	1	NA	NA	SR (strap attachment) BK (Belt keeper)
BB	Battle Belt	2	6	One side	A(no loop), B(D-ring)
BC	Battle Belt COMBO	NA	NA	NA	A(no loop), B(D-ring)
PD	Battle Belt Pad	NA	NA	NA	A(Flat), B(3D)
RH	Rescue Harness	1	5	Oneside	A
PC	Patrol Belt Combo	NA	NA	NA	A(Flat), B(3D)









































Example:

No Loop    Black    "M" Size    "G2" Buckle    1.50" Width Webbing    Yes Binding

TB-D-8126-24









Digits	1	2
	Loop Design	Color
1	Nylon loop	Black
2	Delta Steel Ring (FP-2010) 	Coyote Brown
3	Para Steel D-ring (FP-2005) 	Foliage Green
4	Steel D-ring (FP-2005-2) 	Grey
5	Nylon Loop (Red )	Multi-Camo
6	Delta Steel Ring/Slider (FP-2013) 	Carbon
7	2 Loops	Basket Weave
8	No Loop	OD-Green
9		1+2+3 
A		Orange
B		Red
C		Neon-Green
D		Neon-Yellow
E		Neon-Orange
F		Blue
H		Neon-Pink
I		Yellow
J		Granite

	3		4		5	6	
	Size		Buckle		Width	Pouch	
	S	28"-33"	Raptor™		1.0"	No Pouch	(RB)
	M	33"-38"	Presto™ Steel		1.5"	Yes Pouch	(RB)
	L	38"-43"	FP-2139-3		1.75"	No Binding	(TB,SB,PR)
	XL	43"-48"	FP-2137		2.00"	Yes Binding	(TB,SB,PR)
	XXL	48"-53"	Raptor™ G1.5		2.25"	HV Fixed	(HB)
	3XL	53"-58"	Raptor™ G2			HV Velcro	(HB)
	4XL	58"-63"	Plastic Buckle			BA Fixed	(BA)
	NA		No Buckle			BA Velcro	(BA)
	2"	(BA)	FP-2999			BA Velcro + Snap	(BA)
	3"	(BA)	Delta Steel Ring (FP-2010)			MOLLE color	 BLK
	4"	(BA)	Para Steel D-ring (FP-2005)			MOLLE color	 CYB
	5"	(BA)	Steel D-ring (FP-2005-2)			MOLLE color	 FLG
			Delta Steel Ring/ Slider (FP-2013)			MOLLE color	 CAMO
						MOLLE color	 ODG
							
							
							
							

# LANYARD OPTIONS CHART

CODE	TYPE
LH	HELO LANYARD
LYH	HELO Y-LEG LANYARD
LD	DOG LEASH
LYD	Y-LEGGED DOG LEASH
LS	SINGLE LANYARD
LY	Y-LEGGED LANYARD
LSP	SHOCK PACK LANYARD
LYSP	SHOCK PACK Y-LEGGED LANYARD

CODE	WEBBING TYPE	WEBBING WIDTH
1	Flat 	0.75"
2	Flat Adjustable 	1.00"
3	Stretch 	1.50"
4	Rope 	1.75"
5		2.00"
6	Die-Electric 	

NO.	HARDWARE A (Person)
NA	NOT APPLICABLE
HL	HITCHED LOOP
SFL	SMALL FLAT LOOP
FL	FLAT LOOP 
GL	GEAR LOOP
FR	FLAT RUBBER
RR	ROUND RUBBER
LL	LARGE LOOP
2999	FP-2999
6013	FP-6013
80012	FP-8001-2
8009	FP-8009
8021	FP-8021
8120BL	FP-8120-BL
9001	FP-9001
9005HS	FP-9005-HS
List the number	AND SO FORTH

Prefix	Type
LH	HELO
Example 	
A	B
LH-32-HL-2999-BK36	

Prefix	Type
LHY	HELO Y-legged
Example 	
A	B
LHY-12-80012-2999-BK24	

Prefix	Type
LD	Dog Leash
Example 	
A	B
LD-32-FR-29992-BK24	

Prefix	Type
LYD	Y-Legged Dog Leash
Example 	
A	B
LD-32-RR-2995-BK36	

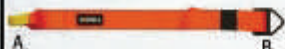
Prefix	Type
LS	Single
Example 	
A	B
LS-24-GL-2013-OR14	

Prefix	Type
LY	Y-Legged
Example 	
A	B
LY-22-HL-61034-RD30	

Thread Color:

Black Webbing - Grey Thread

Color Webbing - Orange Thread

	CODE	HARDWARE A (Person)
	NA	NOT APPLICABLE
	HL	HITCHED LOOP
	SFL	SMALL FLAT LOOP
	FL	FLAT LOOP
	GL	GEAR LOOP
	FR	FLAT RUBBER
	RR	ROUND RUBBER
	LL	LARGE LOOP
	2999	FP-2999
	6013	FP-6013
	80012	FP-8001-2
	8009	FP-8009
	8021	FP-8021
	8120BL	FP-8120-BL
	9001	FP-9001
	9005HS	FP-9005-HS
	List the number	AND SO FORTH

CODE	WEBBING COLOR	LENGTH (Inch)	
BK	BLACK:	12	12"
CB	COYOTE BROWN:	13	13"
FG	FOLIAGE GREEN:	14	14"
RD	RED:	15	15"
BL	BLUE:	16	16"
OR	ORANGE:	17	17"
GY	GREY:	18	18"
OD	ODG:	19	19"
YW	YELLOW:	20	20"
BK/OR	BLK/ORG:	21	21"
OR/GY	ORG/GRY:	22	22"
		AND SO FORTH	

MAIN CHART

EXAMPLE

Prefix	Type
LSP	Shock Pack
Example	
A	B
LSP-15-6013-GL-BK12	

Prefix	Type
LYSP	Shock Pack Y-Legged
Example	
	B
	A
	B
LYSP-55-8003BL-8009-BK72	



# DECLARATIONS PAGE

## WARNING! MUST READ BEFORE EACH USE!

FUSION Products are designed and tested specifically for mountaineering, climbing, and technical rope work under normal climate conditions only. All FUSION Products are designed and tested specifically for human support only. Do NOT use for lifting objects. Each person should have one connection point using equipment or gear that is rated greater than 5,000 lb. The manufacturer's suggested Max Working Load Limit (WLL) for any FUSION Carabiner and connectors is 448 lb (2 kN). Do not use product exceeding its Max Working Load Limit (WLL). These activities are inherently dangerous and present the risk of serious injury or death. The user is responsible for following NFPA, OSHA, ANSI and all other applicable State and Federal Regulations regarding use of these products. The user is responsible for the proper care and maintenance of this product. If in doubt for any reason on the safe conditions of this product, replace it immediately. Any litigation involving this product will be in State of California pursuant to California Law. User must obtain qualified instruction on the proper use, techniques, and limitations involved in use of this product. The user of FUSION Products assumes all risks and accepts full responsibility for any and all damages and injuries of any kind, including death, which may result from the use of any FUSION Products. The user is fully aware that improper use, abuse, or lack of proper care and maintenance of this product will result in serious injury or death.

Activities such as mountaineering, rock climbing, rappelling, canyoneering, zip-lining, aerial rescue, and work at height involving the use of the product are inherently dangerous.

## You are responsible for your own actions.

Before using FUSION Products, you must:

- Read and understand all instructions before use.
- Learn and accept the risks involved.
- Have received qualified instruction in its proper use.
- Be acquainted with the product's capabilities and limitations.

## WARRANTY POLICIES

Equipment offered by FUSION is warranted against factory defects in workmanship and material for a period of one year from the date of purchase/shipment. Limitations of the guarantee are as follows: Abuse, negligence, normal wear and tear, modifications, improper storage, or corrosion but not limited to: Improper care and cleaning, damage due to use for which the product was not designed, and equipment abuse. Also excluded from the guarantee is damage due to transit, accidents, negligence. FUSION will repair or replace defective merchandise at its discretion. The FUSION Warranty is null and void if the product has been modified or altered in any way, including, but not limited to: Removal of a harness's identification or warning labels or instructions.

The Warranty only applies to the original purchaser; the Warranty only applies to products from FUSION. FUSION reserves the right to inspect the product submitted for replace or repair prior to giving a replacement or credit. If the product manufacture date falls outside the one year guarantee limit, or if the damage is due to user neglect or improper usage, the Warranty Department will contact you to discuss repair options and possible charges. You will not be charged without your consent.

## USER'S RESPONSIBILITY

Although the FUSION products are designed to help you prevent injury, however, it still is a system like others where No Guarantee of 100% from injury or death can be prevented. FUSION will not be responsible for any liability or claims on the products we manufacture. If you, as the user of this product, decide to use this product without receiving proper training and safety awareness program, then you assume 100% liability. This means even in the case of serious injury or even death, FUSION, will not take any liability for your inability to follow directions from the outset.

## DISCLAIMER

The customer accepts full responsibility for any and all incidents, accidents, injuries, deaths and property damage that may and probably will occur during the building and operating of your zip line, ropes course, adventure course, climbing wall, or anything you have built using gear, equipment, or information purchased or acquired from any representative, our web site, or any affiliate site or company. Seek professional and competent advice if you are unsure of how to work with trees, cable installation or maintenance. All information related to zip line received from any representative or printed material distributed by FUSION is an opinion and shall not be interpreted as expert or professional advice. FUSION is not responsible for anything that may go wrong with your zip line installation, trees, gear, trolleys or related components. We are not responsible for any injuries or deaths that occur during the construction or operation of your zip line or adventure course. No warranty related to zip lines is expressed or implied by installation tips, construction guides, or by any representative of FUSION. Educate yourself on the proper installation, maintenance and use of everything related to your zip line or adventure course. Contact component manufacturers for information about warranty and use of their products. Serious injury and death may occur as a result from improper use of this equipment. This equipment has been designed and manufactured for use by professionals only. Do NOT attempt to use this equipment without proper training! If in doubt on the safety of this product, Label "Do Not Use" and remove the product from service. Inspect all equipment before each use. Destroy any gear that is damaged, worn, or does not pass inspection. Any Person using these products is responsible for the proper care and maintenance of these products.

WHEN IN DOUBT, REPLACE IT! Any person using these products in any manner assumes all risks and responsibility for any damage or injury, including death, dismemberment or worse. Any litigation involving these products will be in California pursuant to California Law.

MADE IN THE USA